

LIMORA

Top 1400

PARTS AND ACCESSORIES FOR

Jaguar XK8 / XKR

1996 to 2011





Spare Parts for Classic British Cars

The cat is back

In 1996, after over 20 years of successful production of the XJS, Jaguar launched the result of Project X100 - the XK8. Based on the XJS floorpan, Geoff Nicholson and his team designed a more curvaceous and aerodynamic Grand Tourer harking back in style to the E-Type and XJ220. The power unit was Jaguar's first production V8. 4 Litres of capacity in aluminium giving 290 bhp. The German ZF 5 speed automatic gearbox was fitted along with new front and rear suspension and an optional electrically controlled adaptive damping system - CATS. ABS and PAS were standard and from 1998 automatic headlamp switching, auto-dipping rear view mirror and a security immobiliser were included. The car was available in coupe and convertible versions and with a choice of classic walnut and leather or sporty dark maple and half-leather trim.

In 1998 the XKR supercharged version was introduced giving 370 bhp from the 4-litre engine. There were also external changes, notably a mesh front grill, bonnet vents and rear spoiler.

In 2000 Adaptive cruise control, integrated Sat Nav and an upgraded audio system were introduced along with electric seat belt tensioning. In 2001 styling changes were made to the front nose, front and rear lighting, rear bumper skirt and larger diameter exhaust tail pipes. Interior changes included side air bags and new seating with adjustable head-rests. The XKR range benefited from larger ventilated disc brakes and Xenon headlights.

The first of a series of Special Edition XKR models was introduced. The Silverstone celebrated Jaguar's return to F1. The limited run of 107 of the Platinum Silver cars for the UK market, was quickly sold out. A second phase of 456 vehicles for the US and Japanese markets, was equally successful.

Jaguar's Special Vehicles Operation department produced their enhanced version of the XKR designated the XKR-R. Significant improvements were introduced across the range of supercharged and normally aspirated vehicles. The larger 4.2 litre engine was fitted with the new ZF 6 speed automatic box. At this point the XKR range benefitted from larger ventilated disc brakes and Xenon headlights. To mark the centenary of Sir William Lyons, the founder of Jaguar, the limited edition of 500 XKR-100 vehicles based on the XKR-R was produced. These vehicles had an anthracite paint finish, 20 inch wheels, Brembro brakes, Recaro seats and exclusive interior and exterior trim features.

In 2004 a limited edition of 200 Portfolio models was produced, mainly for the US with some sales in France. Half were finished in red and the other half in blue. All had 20 inch wheels and Recaro seats.

In 2005 various styling alterations were made and what were to be the final production models were introduced as special editions - XKR 4.2S for the European market and XKR-Victory for the US market.

On May 27th 2005 the last of 90,616 XKs based on the 1996 X100 design was produced at Browns Lane. In September 2005 the new Jaguar XK - Project X150 was unveiled at the Frankfurt Motor Show. The project was under the control of Jaguar Design Director Ian Callum whose design CV included the Aston Martin DB9 and Vanquish models. Indeed there are definite similarities in the new XK to the Astons. Very little apart from a 300 bhp version of the 4.2 engine survived from the old XK models though the front grill still evokes the E-Type style.

The bodywork was an aluminium monocoque design as used on the XJ series. Gear changes to the new Jaguar 6 speed sequential box could be made using steering wheel paddles. 0 to 60 was achieved in 5.9 seconds. Interior quality was maintained with stitched leather and a choice of Aluminium, Walnut or wood finishes. The in-car entertainment was high-end with integral Bluetooth facilities. Jaguar were proud of their installed feature for the protection of pedestrians colliding with the front of the vehicle. Such an event triggered the 'popping up' of the bonnet so that it cushioned the pedestrian from hitting the engine block through the bonnet skin - a similar principle to the air bag.

Initial production models of the new XK were normally aspirated. In November 2007 the supercharged XKR version was launched producing 420 bhp giving 0-60 in 5 seconds and a limited top speed of 155 mph.

The XKR Portfolio Limited Edition was produced in 2007 and the XKR-S (200 units) was launched at the Geneva Motor Show in 2008. These were the result of a cooperation between Jaguar Special Vehicles and British Competition Brake specialist - Alcon. Naturally the main technical features were the 400 mm diameter front discs and 350mm diameter rear discs. All discs were radially ventilated to reduce fade and give maximum cooling with grooved friction surfaces for water expulsion. The distinctive red callipers had 6 cylinders at the front and 4 at the rear. The system had been exhaustively tested throughout Europe and in particular at the Nurburgring in Germany. The XKR-S now had a top speed limited to 174 mph.

The 60th anniversary of the Jaguar XK120 was marked by the special edition XK60 in 2008. Various exclusive changes were made to the wheels and body styling.

In 2009 the 5-litre engine was introduced across the range giving 380 bhp normally aspirated and 503 bhp in the supercharged versions. In this year the XKR Goodwood Special was unveiled as a prototype at the Goodwood Festival of Speed.

In 2010 the XKR 75th Anniversary Edition was introduced at the Goodwood Festival of Speed. Only 75 units were produced. The enhanced performance gave 0-60 in 4.4 seconds and the limited top speed of 174 mph.

At the 2010 Geneva Motor Show the two special options - Speed Pack and Black Pack were unveiled. The names are self-explanatory. The Speed Pack was available separately but the only other option was the combined Speed and Black Pack. The result was the fastest XK produced. In 2011 the XKR E-Type 50th Anniversary Edition was produced with production limited to 25 units.

In 2011 the Instant Tyre Repair system was introduced thus making the spare wheel well available for a purpose designed accessory suitcase.

Production of the XK continues.

Your Team Limora

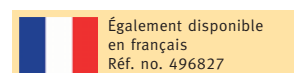
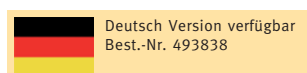

Online price list

This catalogue is also available on the internet, with a convenient online order function. Due to the very large number of parts described in this catalogue it was not possible to include a printed pricelist. Our prices can be viewed online and are updated frequently. Please use the internet for further information and for reference. We are happy to assist you, if you have questions: Just call, fax or send an email.



General certification (ABE)

Please note for all repair and conversion work on a motor vehicle, the statutory provisions relating to road safety and operating permits pertain. We offer in our catalog, parts that are not approved for road transport and may only be installed in vehicles that are used on the racetrack. In addition, the tax and insurance-related treatment depends on a vehicle being in its original state. An article listed here does not necessarily have a general operating permit. Depending on the type of part the comparison to the original factory version is important. If in doubt please contact the competent licensing authority or any government-approved testing agencies like the German TUV or DEKRA).

© 2012 by LIMORA Oldtimer GmbH & Co. KG

The content of this catalogue comprising text and illustrations is the subject of copyright protection. Limora Oldtimer GmbH & Co. KG is the owner of all such copyrights. No part of this publication may be copied, reproduced, stored in any retrieval system, communicated or transmitted in any form or by any means, including Photocopying, Electronic, Mechanical or otherwise, without prior written permission from Limora Oldtimer GmbH & Co. KG.

The catalogue team

Project management: Steffen Schwarz
 Catalogue team: Steffen Schwarz and Sabrina Frins
 Foreword: John Collins
 Research team: Steffen Schwarz and Hans Smid
 Photographs: Dennis Buckow, Florian Hering and Luisa Nodal
 Layout: Sabrina Frins
 Proofreading: John Collins

Part numbers

German catalogue: 493838
 English catalogue: 496826
 French catalogue: 496827

First issue June 2012



Limora supports the sponsorship of children „Plan International“ (www.plan-international.org) Take part in it!

Production figures XK8 and XKR to 2005 MY. For the new generation of the XK there are no production figures available.

XK8 & XKR	1995	1996	1997	1998	1999	2000	2001	2002	2003	2004	2005	TOTAL
XK8 Coupe	8	2.925	5.141	3.319	1.701	1.514	1.723	1.203	985	627	666	19.812
XK8 Convertible	12	4.187	9.765	7.662	6.196	5.907	4.404	2.910	2.280	2.003	1.687	47.013
XKR Coupe			11	1.402	1.530	1.778	1.659	1.053	936	708	669	9.746
XKR Convertible			22	838	1.994	3.042	2.949	1.695	1.455	1.075	985	14.045
Production by year	20	7.112	14.929	13.221	11.421	12.241	10.735	6.861	5.656	4.413	4.007	90.616

Many thanks to Stefan Buechling, Uli Mader and Christoph von Berlin for the photographs of their beautiful cars



LIMORA

Spare Parts for Classic British Cars

Dear Clients, Enthusiasts, Drivers of all makes!

With more than 20 leading catalogues, 5 stores all over Germany. As soon as you need spare parts, consumables, tools or accessories: Contact us first. Visit our shops in the „Meilenwerk“ estates in Stuttgart, Duesseldorf, Berlin and Hamburg or visit our 600 square metre shop in Aachen.

We try hard to make your visit a real experience. Touch, feel and try most of the products we offer in our accessories catalogue „Old love never dies“. And in case any questions remain, please contact our competent staff. Books, magazines, manuals and cuppa or coffee: Be our guest.

Limora offers regular seminars on technical and historical topics, readings and excursions. Find out what we can do for you: Order your free catalogue for your British classic car today, and don't forget to ask for the free paperback „Old love never dies“, with lots of relevant information concerning your favourite hobby.

We would love to welcome you.

Your Team Limora

Order catalogue:



Our new catalogues!
Now available online
with order function!



Visit our Online Shop: www.Limora.com

<p>800 pages</p>	<p>1000 pages</p>	<p>290 pages</p>	<p>290 pages</p>	<p>64 pages</p>	<p>500 pages</p>
<p>300 pages</p>	<p>320 pages</p>	<p>600 pages</p>	<p>600 pages</p>	<p>690 pages</p>	<p>580 pages</p>
<p>64 pages</p>	<p>800 pages</p>	<p>600 pages</p>	<p>324 pages</p>	<p>80 pages</p>	<p>740 pages</p>

Introduction 1
 Copyright 2
 Production figures 2
 Content 4
 Changes during production 6
 Index 158



1. Engine

- 1.1 Cylinder block, oil sump and crankshaft 8
- 1.2 Cylinder head, camshaft and timing chain 13



2. Automatic transmission

- 2.1 Gaskets and oil seals 16



3. Clutch

Not applicable for this car



4. Cooling system

- 4.1 Radiator, thermostat and water pump 18
- 4.2 Supercharger cooling system 20



5. Engine controls

- 5.1 Accelerator cable and engine sensors 22



6. Fuel injection and air filter

- 6.1 Fuel injectors, manifold gaskets, throttle body and air filter 26



7. Fuel system

- 7.1 Fuel pump, fuel filter and sender unit 30



8. Front suspension

- 8.1 Shock absorber, wishbones and ball joints to 2005 MY 32
- 8.2 Shock absorber, wishbones and ball joints from 2006 MY 37



9. Manifold and exhaust system

- 9.1 Exhaust systems and gaskets to 2005 MY 40
- 9.2 Exhaust systems and gaskets from 2006 MY 44



10. Steering

- 10.1 Track rod ends, steering rack, pump and gaiters to 2005 MY 46
- 10.2 Track rod ends, steering pump and gaiters from 2006 MY 48



11. Rear suspension

- 11.1 Shock absorber, wishbones and coil springs to 2005 MY 49
- 11.2 Shock absorber and wishbones from 2006 MY 53
- 11.3 Differential - to MY 2005 56



12. Brakes

- 12.1 Front brakes - to 2005 MY 58
- 12.2 Front brakes - from 2006 MY 63
- 12.3 Rear brakes - to 2005 MY 65
- 12.4 Rear brakes - from 2006 MY 69
- 12.5 Hand brake, brake hydraulics and wheel speed sensors - to 2005 MY 71
- 12.6 Hand brake, brake hydraulics and wheel speed sensors - from 2006 MY 75



13. Road wheels

- 13.1 Road wheels and tyres77



18. Body fittings and external trim parts

- 18.1 Badges and nameplates - to 2005 MY110
- 18.2 Badges and nameplates - from 2006 MY.113
- 18.3 Body fittings.115



14. Electrics and heating

- 14.1 Starter motor and alternator80
- 14.2 Ignition system82
- 14.3 Heater unit and water hoses83
- 14.4 Air conditioning88
- 14.5 Headlamps, side lamps and rear lamps.91
- 14.6 Windscreen wiper, and wiper motor96
- 14.7 Fuses, relays and switches99

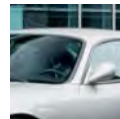

19. Mirrors, glass and glazing

- 19.1 Glass and glazing117
- 19.2 Door mirrors and interior mirror119



15. Body panels

- 15.1 Repair panels103

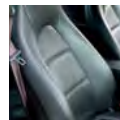

20. Interior trim

- 20.1 Footwell carpets, gear knobs and threshold plates122



16. Bumpers

- 16.1 Bumpers.106



21. Competition parts and accessories

- 21.1 Competition parts129
- 21.2 Special car tools135
- 21.3 Workshop tools.138
- 21.4 Accessories143
- 21.5 Books152
- 21.6 Oils, lubricants, fluids and additives.154



17. Radiator grille

- 17.1 Radiator grille109

Components of the Vehicle Identification Number (VIN)

Position	1	2	3	4	5	6	7	8	9	10	11	12
VIN	S	A	J	J	G	A	E	D	4	A	A	123456

Comment:

The vehicle serial number (the last 6 digits of the VIN) is required for ordering parts

Position 1 to 3	Manufacturer code (SAJ = Jaguar)					
Position 4 to 9	Vehicle descriptor section					
Position 10	Vehicle model year					
Position 11	Model line and assembly plant					
Position 12	Vehicle serial number (last 6 digits) <input type="text"/>					

MODELL YEAR	CAR FIGURED	VIN NUMBER	ENGINE NUMBER
1996	First XK8 in February	001001	
1996	Cylinder liners with Nikasil coating were fitted to all engines	001036	
1996	Start of 1997 Model Year	001246	
1997	First XK8 in January 1997	unknown	
1997	New interior mirror	011699	
1997	Last XK8 in 1997 Model Year	018107	
1997	Start of 1998 Model Year	018108	
1997	New air conditioning compressor	019725	
1998	First XK8 in January 1998	unknown	
1998	Start of the 1998 ½ Model Year with following modifications: Introduction of the supercharged version XKR with 370 BHP, 5-speed Mercedes-Benz automatic transmission and adaptive control damping (C.A.T.S.). The C.A.T.S. suspension system was optional available for non supercharged models	024687	
1998	Last XK8 in 1998 Model Year	031302	
1998	Start of 1999 Model Year with following modifications. The 76 mm front wheel bearings were replaced by an improved version with 80 mm diameter. Accordingly new hub carrier fitted to suit	031303	
1999	First XK8 in January 1999	unknown	
1999	New type of radiator anti-freeze with 2-Ethylhexanoic acid	042635	
1999	Last XK8 in 1999 Model Year	042775	9810290000
1999	Changes to the Vehicle Identification number (VIN). The 6-digit number range at the end of the VIN starts with a character which describes the Model Year. Start of 1999 Model Year with following changes. The Nikasil coated cylinder liners were replaced by a more reliable steel version. Jaguar solved this problem within their guarantee. Further modifications to the cam cover gaskets and the gaskets between the spark plugs and the cylinder heads	A00001	9803250000
1999	The R-Performance option (Brembo brakes) with 355 mm discs are offered for XK8 and XKR models as an optional accessory. New wheel studs fitted to suit	A00083	
1999	Start of 2000 Model Year	A00116	
1999	Introduction of the XKR Silverstone edition with 20" BBS wheels, R-Performance option (Brembo brakes) and a custom interior with red-stitched black leather and birds-eye maple wood	A00116	
2000	First XK8 in January 2000	A04808	
2000	Facelift with changes which included a revised splitter bar across the nose for XK8 models, flush mounted front auxiliary driving lights, and at the rear revised light units with chromed surrounds, a deeper „skirt“ to the rear bumper, larger diameter exhaust tailpipes and the addition of a chromed boot plinth incorporating, for the first time, a push-button boot release. Internally there were new styled seating incorporating adjustable head restraints and side airbags (ARTS)	A11051	
2000	Last XK8 in 2000 Model Year	A11139	
2000	Start of 2001 Model Year	A11140	
2001	First XK8 in January 2001	A17049	
2001	In August last XK8 in 2001 Model Year	A24195	
2001	Start of 2002 Model Year in August with following modifications: improved cast aluminium timing chain tensioners with synthetic surface. Chances to chain tensioner blades timing chains to suit	A24196	0108130000
2002	First XK8 in January 2002	A27749	
2002	In June last XK8 in 2002 Model Year. This was the last XK8 with a 4 litre engine who left the Browns lane plant.	A30644	0008210147

MODELL YEAR	CAR FIGURED	VIN NUMBER	ENGINE NUMBER
2002	Start of the 2003 Model Year in June with following modifications: a larger 4.2 litre version of the V8 engine (both normally aspirated and supercharged) mated to a new 6-speed ZF automatic transmission. Changes to the exhaust system to suit. Also new starter motor, alternator, air condition compressor as well as Xenon headlamps and new designed rear lamps fitted. Improved braking system for non supercharged models. All XKR models were thereafter equipped with a larger, more powerful Brembo braking system	A30645	0008210148
2003	First XK8 in January 2003	A34610	
2003	First XK8 in 2004 Model Year	A36874	
2004	First XK8 in January 2004 with following modifications: updated engine drive belt idlers and pulleys. Rear silencer in new design	A40265	
2004	First XK8 in 2005 Model Year	A42348	
2005	First XK8 in January 2005	A44678	
2005	The 4.2-S Edition was unveiled at Geneva on 1 March 2005. This was the last XK to be rolled out that was based upon the original 1996 design. Features for the 4.2-S included new exterior and interior colours and two distinct veneer options for the instrument panel, polished door threshold plates with chequered-flag emblems and embossed, leather-edged floor mats. The revised white Jaguar badge on the bonnet also feature chequered accents. New 19" Atlas wheels plus cross-drilled Brembo brake discs, red wheel badges and red brake callipers were also fitted	unknown	
2005	The first generation XK8 and XKR models were discontinued in May. In total 90.616 cars were produced at Browns lane plant	A48684	
2006	The New XK (project code X150) was launched in March 2006. The replacement models bore a „rough“ resemblance to the previous cars but the only carryover aspects were the 4.2 litre engine and gearbox. The bodywork was all new, now produced in lightweight aluminium featuring for the first time on a Jaguar what they called „signature“ vertical vents in the front wings. There was also a re-designed interior with the option of different wood or alloy treatment and updated equipment levels. Front and rear suspensions were also new	B00379	
2006	The New XK was joined by the XKR supercharged versions, now producing 420 bhp. Again with a mesh grille, bonnet vents, new badging, a new style front bumper area, four exhaust tailpipes and an alloy finish to the side „signature“ vents. Internally revised trim and seating identified the XKR models. An optional XKR-S version was launched with new 20" forged alloy wheels, a cross-drilled Alcon braking system with 400 mm diameter front and 350 mm rear discs, 6-piston front callipers and 4-piston rear callipers. Also the suspension was recalibrated. All production of this model was only sold into European markets	B11079	
2007	Updated Supercharged drive belt idlers and pulleys	B17759	
2007	Jaguar launched in mid-year a new 3.5 litre V8 engine with 262 bhp output	B19991	
2009	Last XK with 3.5 and 4.2 engines	B32752	
2009	Jaguar launched the 2010 Model Year facelift versions of the second generation XK and XKR. The cars feature a new 5.0 litre V8 engine developing 385 bhp in normally aspirated form and 510 bhp supercharged. Enhanced steering and braking systems were incorporated along with the fitting of the JaguarDrive control for ZF automatic transmission. Three models were now available in both convertible and coupe form, the XK, XKR and Portfolio (XK models with an enhanced specification)	B32753	
2010	First XK in 2011 Model Year	B38854	
2011	First XK in 2012 Model Year. The new XK distinguished by a more aggressive looking front bumper, re-profiled side skirts, additional air vents on the hood and bumpers, a large rear wing and a redesigned rear bumper housing a diffuser and quad tail pipes. Introduction of new XKR-S at the Geneva Motor show which comes with an uprated supercharged V8 engine, overhauled suspension and new aerodynamic enhancements	B44939	

1. CYLINDER BLOCK, OIL SUMP AND CRANKSHAFT

1. OIL FILTER

spin on type

XK8 4.0 to VIN A30644

Jaguar oil filter Part no. 329247
 Reproduction oil filter Part no. 256255

**XK8 4.2 from VIN...A30645 to B32752,
 XK8 3.5 from VIN...B00379 to B32752**

Oil filter Part no. 486167

XK8 5.0 from VIN...B32753

Oil filter Part no. 495220

Matching FilterMag in Chapter 21.1



1.

2. BLANKING PLUG

oil drain

including sealing washer
 Part no. 281190



Matching oil drain valve in Chapter 21.1

4. IDLER PULLEY

for engine drive belt

mounted to alternator bracket

**XK8 4.2 from VIN...A30645 to B32752,
 XK8 3.5 from VIN...B00379 to B32752**

Part no. 495632

5. TENSION PULLEY

for engine drive belt

mounted to steering pump

**XK8 4.2 from VIN...A39973 to B32752,
 XK8 3.5 from VIN...B00379 to B32752**

Part no. 495631



4.



5.

3. CONVERSION KIT

for engine drive belt

XK8 4.0 from VIN...A30644

Improved version idler pulley and tension pulley made from high quality steel.

Jaguar has updated the drive belt idlers and pulleys. Unfortunately, when one of them fails, all the following components must be replaced as a set.

Part no. 286013



6. BRACKET

for engine drive belt tension pulley

XK8 4.2 from VIN...A30645 to A39972

must be used together with pulley 495631

Part no. 495633



6.

7. DRIVE BELT ENGINE

multi groove type

XK8 4.0 except Supercharged to VIN...042775
 with 7 grooves Part no. 285954

XK8 4.0 Supercharged to VIN...042775,
all XK8 4.0 from VIN...A00083 to A30644
 with 7 grooves Part no. 434967

XK8 4.2 from VIN...A30645 to B32752,
XK8 3.5 from VIN...B00379 to B32752
 with 6 grooves Part no. 480001

XK8 5.0 except Supercharged from VIN...B32753
 with 6 grooves Part no. 495242

XK8 5.0 Supercharged from VIN...B32753
 with 6 grooves Part no. 495243



7.

8. CONVERSION KIT

for supercharger drive belt

**XK8 4.0 Supercharged to VIN...A30644,
XK8 4.2 Supercharged from VIN...A30645
to B17758**

Improved version idler pulley and tension pulley
made from high quality steel.

Jaguar has updated the drive belt idlers and
pulleys. Unfortunately, when one of them fails,
all the following components must be replaced
as a set.

Part no. 495238



**XK8 4.2 Supercharged
from VIN...B17759 to
B32752**

9. IDLER PULLEY

for supercharger drive belt
mounted to pulley bracket
Part no. 389559

10. BRACKET

for idler pulley
Part no. 435256

11. TENSION PULLEY

for supercharger drive belt
Part no. 435265

12. DRIVE BELT SUPERCHARGER

multi groove type with 8 grooves
Part no. 480000

**XK8 5.0 Supercharger from
VIN...B32753**

13. DRIVE BELT SUPERCHARGER

multi groove type with 8 grooves

Part no. 495244

14. CONVERSION GASKET SET

with oil seals

XK8 4.0 and 4.2 to VIN...A48684

Part no. 278598



15. OIL SUMP GASKET

XK8 4.0 and 4.2 to VIN...A48684

Part no. 285942

XK8 3.5 and 4.2 from VIN...B00379 to B32752

Part no. 435277



1. CYLINDER BLOCK, OIL SUMP AND CRANKSHAFT

**XK8 4.0 to engine
no. 0108122359****16. TIMING CHAIN**

crankshaft, primary chain

Qty. required: 2 Part no. 256252

17. TIMING CHAIN TENSIONER

for primary timing chain

Qty. required: 2 Part no. 374363

18. PAD

for tensioner on primary timing chain - plastic

Qty. required: 2 Part no. 285949

19. GUIDE

for primary timing chain - plastic

Qty. required: 2 Part no. 434956

**XK8 4.0 to engine
no. 0108130000, XK8 4.2
from VIN...A30645 to
B32752, XK8 3.5 from
VIN...B00379 to B32752****20. TIMING CHAIN**

crankshaft, primary chain

Qty. required: 2 Part no. 374358

21. TIMING CHAIN TENSIONER

for primary timing chain

Qty. required: 2 Part no. 374363

22. PAD

for tensioner on primary timing chain - steel

Qty. required: 2 Part no. 489930

23. GUIDE

for primary timing chain - steel

Qty. required: 2 Part no. 374364



Secondary timing chains in Chapter 21.1

24. TIMING CHAIN KIT

complete engine set

XK8 4.0 to engine no. 0108122359

Part no. 492434

As a result of problematic timing chain tensioner design and other factors like engine overheating or poor maintenance, the plastic cam chain tensioners on 1997 to 2002 V8 Jaguars began to experience stress fractures, and so did some of the plastic guides. While the cars were under warranty, many tensioners were replaced by Jaguar service departments with improved components. Engines subject to this problem include XK8 / XKR engines with the last six digits of their VIN numbers between 001001 and A24195. In the 2002 model year Jaguar began installing upgraded plastic tensioners. These second-generation units are, to the best of our knowledge, more reliable than the early version.



25. SPARK PLUG

XK8 4.0 except Supercharged to VIN...018107

Qty. required: 8 Part no. 494616

XK8 4.0 except Supercharged from VIN...018108 to 031302

Qty. required: 8 Part no. 435116

XK8 4.0 except Supercharged from VIN...031303 to VIN...A30644

Qty. required: 8 Part no. 356293

XK8 4.0 Supercharged to VIN...A00115

Qty. required: 8 Part no. 435120

XK8 4.0 Supercharged from VIN...A00116**to A30644, XK8 4.2 from VIN...A30645 to B32752, XK8 3.5 from VIN...B00379 to B32752**

Qty. required: 8 Part no. 356293

XK8 5.0 except Supercharged from VIN...B32753

Qty. required: 8 Part no. 494659

XK8 5.0 Supercharged and XKR-S edition from VIN...B32753

Please note: This item can only be ordered with the full Vehicle identification number (VIN) for the vehicle.

Qty. required: 8 Part no. 495213



25.

Jaguar's recommendation:

26. CASTROL FULL SYNTHETIC OIL

Edge SAE 0W/30

XK8 4.0 and 4.2 including Supercharged to VIN...A48684, XK8 3.5 and 4.2 except Supercharged from VIN...Boo379 to B32752
5 litre canister Part no. 495413

Product features:

- Best oil for modern high performance engines
- Lower fuel consumption
- Fully synthetic technology

Product benefits:

- Improves engine performance even through extended service intervals
- Easier to start in all weather
- Protects from the moment you start the engine
- Improves acceleration
- Reduces fuel consumption leading to lower running costs
- Reduces engine wear – peace of mind against breakdown

Technical specifications and approvals:

- ACEA A3/B3, A3/B4
- API SM/CF
- BMW Longlife-01
- GM-LL-A-025, GM-LL-B-025
- MB-Approved 229.3, MB-Approved 229.5
- VW 502 00 / 503 01 / 505 00

27. CASTROL FULL SYNTHETIC OIL

Magnatec SAE 5W/30 C3

XK8 4.2 Supercharged from VIN...Boo379 to B32752
5 litre canister Part no. 472241

Castrol Magnatec 5W-30 A3/B4 intelligent molecules cling to critical engine parts to provide an extra layer of protection. With up to 75% of engine wear happening whilst your engine's warming up, Castrol Magnatec's molecules are always there, always ready, drastically reducing* engine wear during this critical start-up and warm-up period.

Castrol Magnatec 5W-30 A3/B4 combining Intelligent Molecules and fully synthetic technology: Clings to your engine forming an extra layer that protects during warm-up and beyond Bonds to metal surfaces making engine parts more resistant to wear

Combine with synthetic technology to provide increased protection in high and low temperature applications

Provide continuous protection for all driving conditions, styles and temperatures

Provides superior performance under extreme cold start up conditions.

Technical specifications and approvals:

- API SM/CF
- ACEA A3/B3, A3/B4, C3
- GM-LL-A-025
- GM-LL-B-025
- BMW approval Longlife-01
- MB approval 229.31
- RENAULT approval RNo700
- VW approval 502 00 u. 505 00
- FIAT approval 9.55535-G1
- JAGUAR approval WSS-M2C913-B

28. CASTROL FULL SYNTHETIC OIL

Edge SAE 5W/20

XK8 5.0 including Supercharged from VIN...B32753
5 litre canister Part no. 495654

Castrol was the first major oil brand to offer a full synthetic 5W-20 that is specifically formulated to meet the needs of Jaguar, Land Rover, Ford, Chrysler, Honda and Toyota 5W-20 service. EDGE 5W-20 provides excellent cold weather performance and exceeds the stringent performance, fuel economy and fuel economy retention requirements of the ILSAC GF-4 specification. EDGE 5W-20 meets the needs of Ford, Honda, Toyota, Chrysler, Dodge, Hyundai and other vehicles where 5W-20 is recommended. EDGE 5W-20 also exceeds all the requirements of ILSAC GF-4 and GF-3 for API Certified Gasoline Engine Oils.

Technical specifications and approvals:

- ACEA A1/B1
- API SL
- Meets Ford WSS-M2C925-A and Ford WSS-M2C925-B
- Meets engine test requirements of A5/B5
- ILSAC GF-3



29. ENGINE MOUNTING

hydraulic

XK8 4.0 and 4.2 to VIN...A48684
Qty. required: 2 Part no. 434490

XK8 3.5 and 4.2 from VIN...Boo379 to B32752
Qty. required: 2 Part no. 495954

XK8 5.0 from VIN...B32753
Qty. required: 2 Part no. 495955



1. CYLINDER HEAD GASKET SET

XK8 4.0 except Supercharged to VIN...A30644 (to engine no. 0008210147)
Part no. 277706

XK8 4.0 Supercharged to VIN...A30644 (to engine no. 0008210147)
Part no. 422409



2.

2. CYLINDER HEAD GASKET

XK8 4.0 to VIN...A30644 (to engine no. 0008210147)
LH side ('B' bank) Part no. 435216
RH side ('A' bank) Part no. 435214

XK8 4.2 from VIN...A30645 (to engine no. 0008210148) to B32752, XK8 3.5 from VIN...B00379 to B32752
LH side ('B' bank) Part no. 487120
RH side ('A' bank) Part no. 487121

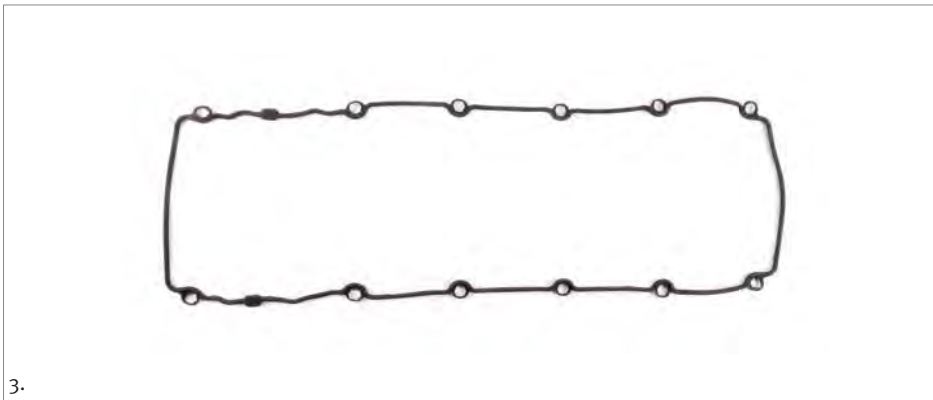

3.

3. GASKET

camshaft cover

XK8 4.0 to engine no. 9810290000
LH side ('B' bank) Part no. 434987
RH side ('A' bank) Part no. 434985

XK8 4.0 except Supercharged from engine no. 9803250000
LH side ('B' bank) Part no. 435294
RH side ('A' bank) Part no. 435293

XK8 4.2 from VIN...A30645 to B32752, XK8 3.5 from VIN...B00379 to B32752
LH side ('B' bank) Part no. 374407
RH side ('A' bank) Part no. 374406

4. CYLINDER HEAD BOLT

XK8 4.0 to VIN...A30644, XK8 4.2 from VIN...A30645 to B32752, XK8 3.5 from VIN...B00379 to B32752, XK8 5.0 from VIN...B32753
Qty. required: 10 Part no. 285981

These so-called stretch bolts are specifically de-signed to give a set length under the right torque. As such they should never be used a second time. The desired bias requires careful installation. The cylinder head bolts are assembled in several stages with a specific tightening torque. When this torque is reached, the bolts are turned further through a defined angle which pre-loads them into a plastic region. We recommend that new cylinder head stretch bolts be used and any work carried out to your engine is done in accordance with a factory workshop manual. Whilst you are doing this job we consider it advisable to replace the water pump and expansion cap to minimise any future problems.



5. RUBBER SEALING RING

spark plug to cylinder head

XK8 4.0 to VIN...042775
Qty. required: 4 Part no. 285978



5.

2. CYLINDER HEAD, CAMSHAFT AND TIMING CHAIN

6. RUBBER SEALING RING

spark plug to cylinder head

XK8 4.0 except Supercharged from VIN...A00001 to A30644

Qty. required: 8 Part no. 435356



7. RUBBER SEALING RING

between spark plugs

XK8 4.0 except Supercharged from VIN...A00001 to A30644

Qty. required: 4 Part no. 492964



8. RUBBER SEALING RING

spark plug to cylinder head

XK8 4.2 from VIN...A30645 to B32752, XK8 3.5 from VIN...B00379 to B32752

Qty. required: 8 Part no. 374408



9. MANIFOLD GASKET

XK8 4.0 and 4.2 to VIN...A48684

exhaust manifold to LH cylinder head

('B' bank). Part no. 435090

exhaust manifold to RH cylinder head

('A' bank). Part no. 435089

XK8 3.5 and 4.2 from VIN...B00379 to B32752

exhaust manifold to LH cylinder head

('B' bank). Part no. 495647

exhaust manifold to RH cylinder head

('A' bank). Part no. 495648



Thermostat housing and cover

including closure and seals. Exact reproduction in aluminum:
Now heat-resistant and durable...

10. THERMOSTAT HOUSING

XK8 4.0 except Supercharged to VIN...A30644

Part no. 488148

Thermostat housing with cover. This upgrade kit replaces the original plastic thermostat housing. We have put together an aluminum thermostat housing assembly, more durable than its plastic counterpart. This kit will include the housing, cap, thermostat cover and seals. This is an exact replacement of the plastic version and will meet or exceed the factory specifications.



11. THERMOSTAT

including 'O' ring

XK8 4.0 to VIN...A30644, XK8 4.2 Supercharged from VIN...A30645 to A48684

Part no. 487154

12. 'O' RING

Thermostat

Part no. 285960



13. THERMOSTAT

4 piece kit

XK8 4.2 except Supercharged from VIN...A30645 to A48684

Part no. 492356

XK8 3.5 and 4.2 from VIN...B00379 to B32752

Part no. 495204



14. 'O'-RING

Thermostat

XK8 4.2 except Supercharged from VIN...A30645 to B32752, XK8 3.5 from VIN...B00379 to B32752

Part no. 492355



15. TIMING CHAIN CAMSHAFT

secondary chain

XK8 4.0 to engine no. 0108122359

Qty. required: 2 Part no. 256253

XK8 4.0 from engine no. 0108130000 to VIN...A30644, XK8 4.2 from VIN...A30645 to B32752, XK8 3.5 from VIN...B00379 to B32752

Qty. required: 2 Part no. 374359



15.

16. TIMING CHAIN TENSIONER

secondary timing chain

XK8 4.0 to VIN...A30644, XK8 4.2 from VIN...A30645 to B32752, XK8 3.5 from VIN...B00379 to B32752

LH side (,B' bank) Part no. 348526

RH side (,A' bank) Part no. 348527



16.
LH side



16.
RH side

Complete timing chain kit in Chapter 1.1 Illustration 24



1. GASKETS AND OIL SEALS

1. GEARBOX GASKET SET

automatic transmission

XK8 4.0 Supercharged to VIN...A30644

Part no. 422165



2. OIL SUMP GASKET

automatic transmission

XK8 4.0 except Supercharged to VIN...A30644

Part no. 421873

XK8 4.0 Supercharged to VIN...A30644

Part no. 348903

XK8 4.2 from VIN...A30645 to B32752,**XK8 3.5 from VIN...B00379 to B32752,****XK8 5.0 from VIN...B32753**

Part no. 495671



3. OIL STRAINER

automatic transmission

XK8 4.0 except Supercharged to VIN...A30644

Part no. 355911

XK8 4.0 Supercharged to VIN...A30644

with 'O' ring and sump gasket assembly

Part no. 348938



4. 'O' RING

for automatic transmission oil strainer

XK8 4.0 except Supercharged**to VIN...A30644**

Part no. 421885



5. DRAIN PLUG

automatic transmission

XK8 4.0 except Supercharged to VIN...A30644

Part no. 421874

XK8 4.0 Supercharged to VIN...A30644

Part no. 421945

6. COPPER WASHER

drain plug

XK8 4.0 Supercharged to VIN...A30644

Part no. 422160



5.



6.

7. OIL SEAL

front oil pump

XK8 4.0 except Supercharged**to VIN...A30644**

Part no. 279260



7.



9.

8. OIL SEAL

selector shaft

XK8 4.0 except Supercharged**to VIN...A30644**

Part no. 279426



8.



10.

9. OIL SEAL

output shaft

XK8 4.0 from VIN...A30644

Part no. 421880

XK8 4.2 from VIN...A30645 to B32752,**XK8 3.5 from VIN...B00379 to B32752,****XK8 5.0 from VIN...B32753**

Part no. 495950

10. 'O' RING

rear housing

XK8 4.0 from VIN...A30644

Part no. 421879

11. GEARBOX MOUNTING RUBBER

XK8 4.0 except Supercharged to VIN...A30644
Part no. 434124

XK8 4.0 Supercharged to VIN...A30644
Part no. 434492

XK8 4.2 from VIN...A30645 to A48684
Part no. 495675



This catalogue is also available in our Online Shop: www.Limora.com



12. AUTOMATIC GEARBOX OIL

XK8 4.0 except Supercharged to VIN...A30644
1 litre bottle Part no. 421900

capacity automatic gearbox: **10 litre**

13. AUTOMATIC GEARBOX OIL

XK8 4.0 Supercharged to VIN...A30644
1 litre bottle Part no. 348154

capacity automatic gearbox: **10 litre**

14. AUTOMATIC GEARBOX OIL

XK8 4.2 from VIN...A30645 to A48684
1 litre bottle Part no. 85554

capacity automatic gearbox: **10 litre**



12.



13.



14.

1. RADIATOR, THERMOSTAT AND WATER PUMP

Thermostat housing and cover

including closure and seals. Exact reproduction in aluminum:
Now heat-resistant and durable...

1. THERMOSTAT HOUSING

XK8 4.0 except Supercharged to VIN...A30644

Part no. 488148

Thermostat housing with cover. This upgrade kit replaces the original plastic thermostat housing. We have put together an aluminum thermostat housing assembly, more durable than its plastic counterpart. This kit will include the housing, cap, thermostat cover and seals. This is an exact replacement of the plastic version and will meet or exceed the factory specifications.



1.

2. THERMOSTAT

including 'O' ring

XK8 4.0 to VIN...A30644, XK8 4.2 Supercharged from VIN...A30645 to A48684

Part no. 487154

3. 'O' RING

Thermostat

Part no. 285960



2.

3.

4. THERMOSTAT

4 piece kit

XK8 4.2 except Supercharged from VIN...A30645 to A48684

Part no. 492356

XK8 3.5 and 4.2 from VIN...B00379 to B32752

Part no. 495204



4.

5. 'O'-RING

Thermostat

XK8 4.2 except Supercharged from VIN...A30645 to B32752, XK8 3.5 from VIN...B00379 to B32752

Part no. 492355



6. WATER PUMP

XK8 4.0, 4.2 and 3.5 to VIN...B32752

Part no. 347746

XK8 5.0 from VIN...B32753 to B44050

Part no. 495286

XK8 5.0 from VIN...B44051

Part no. 495684



6.

7. GASKET

water pump

XK8 4.0, 4.2 and 3.5 to VIN...B32752

thickness: 0.4 mm Part no. 487153

thickness: 1.5 mm. Part no. 355851

XK8 5.0 from VIN...B32753 to B44050

Qty. required: 2 Part no. 495685



7.

8. RADIATOR

with high efficiency aluminium cord

XK8 4.0 except Supercharged to VIN...A30644

Part no. 433667

XK8 4.0 Supercharged to VIN...A30644

Part no. 433669

XK8 4.2 except Supercharged from von VIN...A30645 bis A48684

Part no. 495282

XK8 4.2 Supercharged from VIN...A30645 to A48684

Part no. 495281

XK8 3.5 and 4.2 from VIN...B00379 to B32752

Part no. 495283

XK8 5.0 except Supercharged from VIN...B32753

Part no. 495284

XK8 5.0 Supercharged from VIN...B32753

Part no. 495285



8.

1. RADIATOR, THERMOSTAT AND WATER PUMP

9. FILLER CAP
expansion tank

XK8 4.0 and 4.2 to VIN...A48684
Part no. 284052



XK8 3.5 and 4.2 from VIN...B00379 to B32752, XK8 5.0 from VIN...B32753 to B36760
Part no. 495969

XK8 5.0 from VIN...B36761
Part no. 495970

10. FLUID LEVEL SENSOR
cooling system expansion tank

XK8 4.0 and 4.2 to VIN...A48684
Part no. 283284



11. RADIATOR HOSE
top

XK8 4.0 except Supercharged to VIN...A30644
Part no. 284060

XK8 4.0 Supercharged to VIN...A30644
Part no. 433690

XK8 4.2 except Supercharged from VIN...A30645 to A48684
Part no. 495953

XK8 4.2 Supercharged from VIN...A30645 to A48684
Part no. 495951

XK8 3.5 and 4.2 except Supercharged from VIN...B00379 to B32752
Part no. 495962

XK8 3.5 and 4.2 Supercharged from VIN...B00379 to B32752
Part no. 495964

XK8 5.0 except Supercharged from VIN...B32753
Part no. 495966

XK8 5.0 Supercharged from VIN...B32753
Part no. 495968



12. RADIATOR HOSE
bottom

XK8 4.0 except Supercharged to VIN...A30644
Part no. 433413

XK8 4.0 Supercharged to VIN...A30644
Part no. 433695

XK8 4.2 except Supercharged from VIN...A30645 to A48684
Part no. 488424

XK8 4.2 Supercharged from VIN...A30645 to A48684
Part no. 488425

XK8 3.5 and 4.2 except Supercharged from VIN...B00379 to B32752
Part no. 495963

XK8 3.5 and 4.2 Supercharged from VIN...B00379 to B32752
Part no. 495965

XK8 5.0 including Supercharged from VIN...B32753
Part no. 495967



12.

13. RADIATOR HOSE
top

XK8 4.0 except Supercharged to VIN...A30644
Part no. 433690

XK8 4.2 except Supercharged from VIN...A30645 to A48684
Part no. 495953

XK8 4.2 Supercharged from VIN...A30645 to A48684
Part no. 495951

XK8 3.5 and 4.2 except Supercharged from VIN...B00379 to B32752
Part no. 495962

XK8 3.5 and 4.2 Supercharged from VIN...B00379 to B32752
Part no. 495964

XK8 5.0 except Supercharged from VIN...B32753
Part no. 495966

XK8 5.0 Supercharged from VIN...B32753
Part no. 495968

13. RADIATOR HOSE
radiator to auxillary radiator, RH side (supply hose)

XK8 5.0 from VIN...B32753
Part no. 495990



13.

14. RADIATOR HOSE
auxillary radiator to radiator, LH side (return hose)

XK8 5.0 from VIN...B32753
Part no. 495989



14.



15. JAGUAR ANTI-FREEZE COOLANT
radiator

XK8 4.0 to VIN...042634
1 litre bottle Part no. 422089
5 litre canister Part no. 422090

XK8 4.0 from VIN...042635, XK8 4.2 from VIN...A30645, XK8 3.5 from VIN...B00379, XK8 5.0 from VIN...B32753
1 litre bottle Part no. 422635
5 litre canister Part no. 422636

Capacity of cooling system: **10 litre**

2. SUPERCHARGER COOLING SYSTEM



1. SUPERCHARGER RADIATOR

XK8 4.0 and 4.2 Supercharged to VIN...A48684
Part no. 434509

XK8 4.2 Supercharged to VIN...Boo379 bis B32752
Part no. 495959

XK8 5.0 Supercharged from VIN...B32753
Part no. 495960

2. WATER PUMP

for supercharger

XK8 4.0 Supercharged, to VIN...A30644, XK8 4.2 Supercharged from VIN...A30645 to B32752, XK8 5.0 Supercharged from VIN...B32753
Part no. 434518



2.

3. HOSE

supercharger to supercharger radiator

XK8 4.0 Supercharged to VIN...A30644
Part no. 433757

XK8 4.2 Supercharged from VIN...A30645 to A48684
Part no. 495717



3.

4. HOSE

supercharger radiator to coolant pump

XK8 4.0 and 4.2 Supercharged to VIN...A48684
Part no. 433753



4.

XK8 4.2 Supercharged from VIN...Boo379 to B32752

5. HOSE

supercharger to coolant pump

Part no. 495975



6.

6. HOSE

coolant pump to supercharger radiator

Part no. 495974



7.

7. HOSE

supercharger radiator to intercooler

Part no. 495976

XK8 5.0 Supercharged from VIN...B32753

8. HOSE

inlet manifold to coolant pump (supply hose)

Part no. 495973

9. HOSE

coolant pump to supercharger radiator

Part no. 495974

10. HOSE

supercharger radiator to inlet manifold (return hose)

Part no. 495977

11. HOSE

connecting supercharger radiator to engine cooling system

Part no. 495979



8.

9.



10.

11.

12. JAGUAR ANTI-FREEZE COOLANT radiator

Capacity of cooling system: **10 litre**

XK8 4.0 to VIN...042634

1 litre bottle Part no. 422089

5 litre canister Part no. 422090

XK8 4.0 from VIN...042635,

XK8 4.2 from VIN...A30645,

XK8 3.5 from VIN...B00379,

XK8 5.0 from VIN...B32753

1 litre bottle Part no. 422635

5 litre canister Part no. 422636



1. ACCELERATOR CABLE AND ENGINE SENSORS

1. ACCELERATOR CABLE

XK8 4.0 LHD except Supercharger models to VIN...A30644
Part no. 433421

XK8 4.0 LHD Supercharger models to VIN...A30644
Part no. 433704

XK8 4.0 RHD except Supercharger models to VIN...A30644
Part no. 433418

XK8 4.0 RHD Supercharger models to VIN...A30644
Part no. 433703

XK8 4.2 LHD Supercharger models to A48684
Part no. 495999

XK8 4.2 RHD Supercharger models from VIN...A30645 to A48684
Part no. 496000



3. SENSOR

to detect camshaft position. Fitted to camshaft cover

XK8 4.0 to VIN...A031302
Part no. 281640

XK8 4.0 from VIN...031303 to A30644
LH (B⁺ bank) Part no. 348093
RH (A⁺ bank) Part no. 348153

XK8 4.2 from VIN...A30645 to B32752, XK8 3.5 from VIN...B00379 to B32752
LH (B⁺ bank) Part no. 495320
RH (A⁺ bank) Part no. 348153

XK8 5.0 ab VIN...B32753
Qty. required: 4 Part no. 496011



2. SENSOR

to detect engine speed and crankshaft position. Fitted to oil sump

XK8 4.0 to VIN...031302
Part no. 281639

XK8 4.0 from VIN...031303 to A30644, XK8 4.2 from VIN...A30645 to B32752, XK8 3.5 from VIN...B00379 to B32752
Part no. 374263

Insider tip



The crankshaft sensor is an inductive type sensor. It consists of a magnet and a coil wound around the magnet. It is triggered by reference points passing the sensor tip. The reference points can be pins mounted to the flywheel in the form of a trigger disc or reluctor. These will divide the 360 degrees rotation of the engine into segments that the engine control can use for the ignition system or for the start of Injection. Each time a reference point passes the tip of the sensor it excites the magnet an ac voltage is then induced in the coil. The AC voltage is sent as a signal voltage back to the engine control unit. The crankshaft sensor or engine speed sensor will have 2 or 3 pins. The 3rd pin is used for a screen. The screen suppresses any interference. The engine management light will be triggered if the crankshaft sensor moves outside of normal operating values. A fault with this sensor may inhibit engine startup.



4. KNOCK SENSOR

XK8 4.0 except Supercharged to VIN...031302, XK8 Supercharged to VIN...042775
Qty. required: 2 Part no. 424975

XK8 4.0 except Supercharged from VIN...031303 to A30644, XK8 4.0 Supercharged from VIN...A00083 to A30644
Qty. required: 2 Part no. 431316

XK8 4.2 from VIN...A30645 to A48684
Qty. required: 2 Part no. 495318

XK8 3.5 and 4.2 from VIN...B00379 to B32752
Qty. required: 1. Part no. 495321

XK8 5.0 from VIN...B32753
Qty. required: 2 Part no. 496005



5. THERMAL TRANSMITTER
air inlet

XK8 4.0 Supercharged to VIN...A30644
Part no. 424980

XK8 4.2 Supercharged to VIN...A30645 bis A48684
Part no. 495322

XK8 5.0 from VIN...B32753
Part no. 496007



6. TEMPERATURE SENSOR
coolant, for thermostat housing

XK8 4.0 to VIN...031302
Identify by 2 pin compact connector with green plastic cap, M12 thread with 19 mm spanner size and cylindrical transmitter without peak
Part no. 282644



7. TEMPERATURE SENSOR
coolant, for thermostat housing

XK8 4.0 and 4.2 from VIN...031303 to A48684
Identify by 2 pin compact connector with grey plastic cap, M18 thread with 19 mm spanner size and cylindrical transmitter without peak
Part no. 433165



8. TEMPERATURE SENSOR
coolant, for thermostat housing

XK8 3.5 and 4.2 from VIN...B00379 to B32752
Identify by 2 pin compact connector with black plastic cap, push fit fitting with 19 mm spanner size and cylindrical transmitter without peak
Part no. 495324



9. TEMPERATURE SENSOR
coolant, for thermostat housing

XK8 5.0 from VIN...B32753
Identify by 2 pin compact connector with grey plastic cap, quick release push fit fitting with and cylindrical transmitter without peak
Part no. 496008



10. TEMPERATURE SENSOR
oil temperature

XK8 4.0 from VIN...031303 to A30644, XK8 4.2 from VIN...A30645 to A48684, XK8 3.5 and 4.2 from VIN...B00379 to B32752
Identify by 2 pin compact connector with grey plastic cap, M18 thread with 19 mm spanner size and cylindrical transmitter without peak
Part no. 433165



11. OIL PRESSURE SWITCH

XK8 4.0 and 4.2 to VIN...A48684
Identify by 1 pin compact connector with black plastic cap, M10 thread with 21 mm spanner size
Part no. 374530



12. OIL PRESSURE SWITCH

XK8 3.5 and 4.2 from VIN...B00379 to B32752
Identify by 1 pin compact connector with green plastic cap, M14 thread with 21 mm spanner size
Part no. 495325



1. ACCELERATOR CABLE AND ENGINE SENSORS

13. SENSOR

air inlet vacuum

XK8 4.0 except Supercharged to VIN...A24195, XK8 4.0 and 4.2 Supercharged to VIN...A43927
Part no. 374403

XK8 4.0 except Supercharged from VIN...A24196 bis A30644, XK8 4.2 Supercharged from VIN...A43928 to A48684, all XK8 3.5 and 4.2 from VIN...B00379 to B32752
Part no. 495323

XK8 5.0 from VIN...B32753
Part no. 496010



15. LAMBDA OXYGEN SENSOR

heated, fitted in front of the catalytic converter

XK8 4.0 with OBD II interface except Supercharged to VIN...031302, XK8 4.0 Supercharged to VIN...042775
Qty. required: 2 Part no. 282083

XK8 4.0 with OBD II interface except Supercharged from VIN...031303 to A30644, XK8 4.0 Supercharged from VIN...042775 to A30644
Qty. required: 2 Part no. 431315

XK8 4.2 from VIN...A30645 to A48684
Qty. required: 2 Part no. 491883



XK8 3.5 and 4.2 from VIN...B00379 to B32752
Qty. required: 2 Part no. 493770

XK8 5.0 from VIN...B32753
Qty. required: 2 Part no. 495327

14. CONTROL VALVE

for variable valve timing

XK8 4.0 to VIN...042775
Qty. required: 2
Part no. 281636

XK8 4.0 from VIN...A00083 to A30644, XK8 4.2 from VIN...A30645 to B32752, XK8 3.5 from VIN...B00379 to B32752
Qty. required: 2
Part no. 433163



16. LAMBDA OXYGEN SENSOR

heated, fitted behind of the catalytic converter

XK8 4.0 from VIN...031303 to A30644
Qty. required: 2 Part no. 431313

XK8 4.2 from VIN...A30645 to A48684
Qty. required: 2 Part no. 495326

XK8 3.5 and 4.2 from VIN...B00379 to B32752
Qty. required: 2 Part no. 495329

XK8 5.0 from VIN...B32753
Qty. required: 2 Part no. 495328



17. LAMBDA SENSOR TESTER

with a fast 20 segment LED display covering a range from 0 to 1 volt. Suitable for cars with electronic fuel injection and catalytic converters. Also useful for testing the ECU injection control unit. Can be simply connected to the on board 12 volt battery with the 2 crocodile clamps. Prevents catalytic converter damage and provides an optimal fuel/air mixture.

Part no. 245164



18. LAMBDA SENSOR CHASER

for cleaning and restoring the sensor bore threads, M18 x 1.5 mm. Can be installed using spark plug wrench or 21 mm socket
Part no. 471256



19. SPECIAL SOCKET

for lambda oxygen sensors with 22 mm spanner size. The cut out socket provides a good grip without damaging the sensor cable, 3/8" drive.
Part no. 469795



1. FUEL INJECTORS, MANIFOLD GASKETS, THROTTLE BODY AND AIR FILTER

1. AIR FILTER

element

XK8 4.0 and 4.2 to VIN...A48684

Part no. 355795

K&N filter in Chapter 21.1



2. AIR FILTER

element

XK8 3.5 and 4.2 from VIN...B00379 to B32752

Qty. required: 2 Part no. 495172

K&N filter in Chapter 21.1

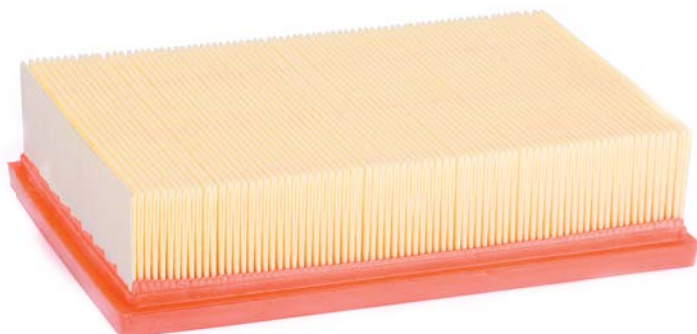

3. AIR FILTER

element

XK8 5.0 from VIN...B32753

Qty. required: 2 Part no. 495173

K&N filter in Chapter 21.1



4. AIR-FLOW METER

XK8 4.0 except Supercharged to VIN...031302

Part no. 282080

XK8 4.0 except Supercharged from VIN...031303 to A30644

Part no. 431311

XK8 4.0 Supercharged to VIN...042775

Part no. 429597

XK8 4.0 Supercharged from VIN...A00083 to A30644

Part no. 431309

XK8 4.2 except Supercharged from VIN...A30645 to A48684

Part no. 392930

XK8 4.2 Supercharged from A30645 to A48684, all XK8 3.5 and 4.2 from VIN...B00379 to B32752

Part no. 496021

XK8 5.0 from VIN...B32753

Part no. 496022

5. SEAL

between air-flow meter and air pipe

XK8 4.0 from VIN...A30644

Part no. 435436



1. FUEL INJECTORS, MANIFOLD GASKETS, THROTTLE BODY AND AIR FILTER

6. THROTTLE BODY

XK8 4.0 non Supercharged models with air assisted fuel injection to VIN...042775
Part no. 431305

XK8 4.0 without air assisted fuel injection to VIN...042775
Part no. 424979

XK8 4.0 Supercharged from VIN...A00083 to A30644
Part no. 431306

XK8 4.0 except Supercharged from VIN...A00083 to A30644
Part no. 431305

XK8 4.2 from VIN...A30645 to A48684
Part no. 495369

XK8 4.2 Supercharged from VIN...B00379 to B32752
Part no. 496018

XK8 3.5 and 4.2 Supercharged from VIN...B00379 to B32752
Part no. 496019

XK8 5.0 from B32753
Part no. 496020



7. FUEL INJECTOR

XK8 4.0 except Supercharged to VIN...031302
Qty. required: 8 Part no. 424973

XK8 4.0 except Supercharged from VIN...031303 to A30644
Qty. required: 8 Part no. 374503

XK8 4.0 Supercharged to A30644
Qty. required: 8 Part no. 424978

XK8 4.2 except Supercharged from VIN...A30645 to A48684
Qty. required: 8 Part no. 495371

XK8 4.2 Supercharged from VIN...A30645 to A48684
Qty. required: 8 Part no. 487895

XK8 3.5 and 4.2 except Supercharged from B00379 to B07773
Qty. required: 8 Part no. 496024

XK8 3.5 and 4.2 except Supercharged from B07774 to B32752
Qty. required: 8 Part no. 496025

XK8 4.2 Supercharged from VIN...B00379 to B32752
Qty. required: 8 Part no. 487896

XK8 5.0 from VIN...B32753
Qty. required: 8 Part no. 496026



8. 'O' RING SET
fuel injector to fuel rail

XK8 4.0 except Supercharged to VIN...042775
Qty. required: 8 Part no. 421939

9. SEALING RING
fuel injector to adaptor

XK8 4.0 Supercharged to VIN...A30644
Qty. required: 8 Part no. 435227



10. RETAINING CLIP

fuel injector

XK8 4.0 and 4.2 except Supercharged to VIN...A48684, XK8 4.2 Supercharged from VIN...A30645 to A47460
Qty. required: 8 Part no. 436375

XK8 4.0 Supercharged to VIN...A30644
Qty. required: 8 Part no. 374235

XK8 4.2 Supercharged from VIN...A47461 to A48684, XK8 3.5 and 4.2 from VIN... B00379 to B32752
Qty. required: 8 Part no. 496028

11. RETAINING CLIP

fuel injector

XK8 5.0 from VIN...B32753
Qty. required: 8 Part no. 496027



12. FUEL PRESSURE REGULATOR

XK8 4.0 except Supercharged to VIN...A30644
Part no. 436427

XK8 4.0 Supercharged to VIN...A30644
Part no. 285989



13. 'O' RING SET

fuel pressure regulator to pipe

XK8 4.0 except Supercharged to VIN...A30644
Part no. 422993



14. SENSOR

fuel pressure

XK8 4.2 from VIN...A30645 to B32752, XK8 3.5 from VIN...B00379 to B32752
Part no. 496017

XK8 5.0 from VIN...B32753
Part no. 496009



1. FUEL INJECTORS, MANIFOLD GASKETS, THROTTLE BODY AND AIR FILTER

15. MANIFOLD GASKET

inlet manifold to cylinder head

XK8 4.0 except Supercharged to VIN...031302

Qty. required: 8 Part no. 285992

XK8 4.0 except Supercharged from VIN...031303 to A30644

Qty. required: 8 Part no. 374451

XK8 5.0 except Supercharged from VIN...B32753

Qty. required: 8 Part no. 496035



16. MANIFOLD GASKET

inlet manifold and adaptor to cylinder head

XK8 4.2 except Supercharged from VIN...A30645 to A36873

Qty. required: 2 Part no. 495372

XK8 4.2 except Supercharged from VIN...A36874 to B32752, XK8 3.5 from VIN...Boo379 to B32752

Qty. required: 2 Part no. 495383



17. RUBBER SEAL

inlet manifold to induction elbow

XK8 4.0 and 4.2 except Supercharged to VIN...A36873

Part no. 285990

XK8 4.2 except Supercharged from VIN...A36874 to B32752, XK8 3.5 from VIN...Boo379 to B32752

Part no. 495373

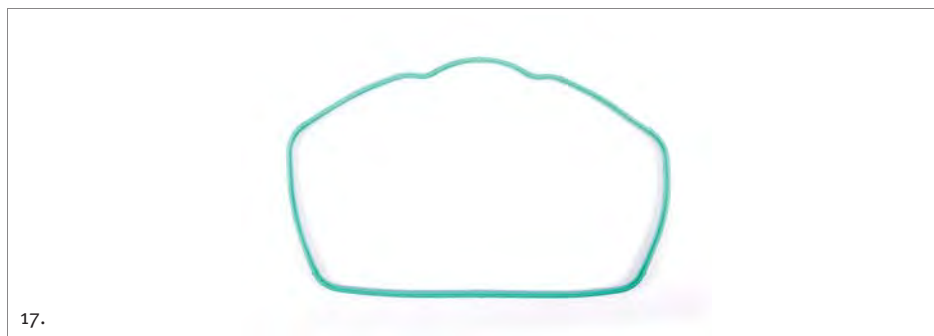

18. MANIFOLD GASKET

inlet manifold adaptor to cylinder head

XK8 4.0 Supercharged to VIN...A30644

Qty. required: 2 Part no. 435229

XK8 4.2 Supercharged from VIN...A30645 to A36873

Qty. required: 2 Part no. 495372

XK8 4.2 Supercharged from VIN...A36874 to B32752

Qty. required: 2 Part no. 495383



19. MANIFOLD GASKET

inlet manifold to manifold adaptor

XK8 4.0 Supercharged to VIN...A30644

Qty. required: 2 Part no. 435228

XK8 4.2 Supercharged from VIN...A30645 to B32752

Qty. required: 2 Part no. 495391

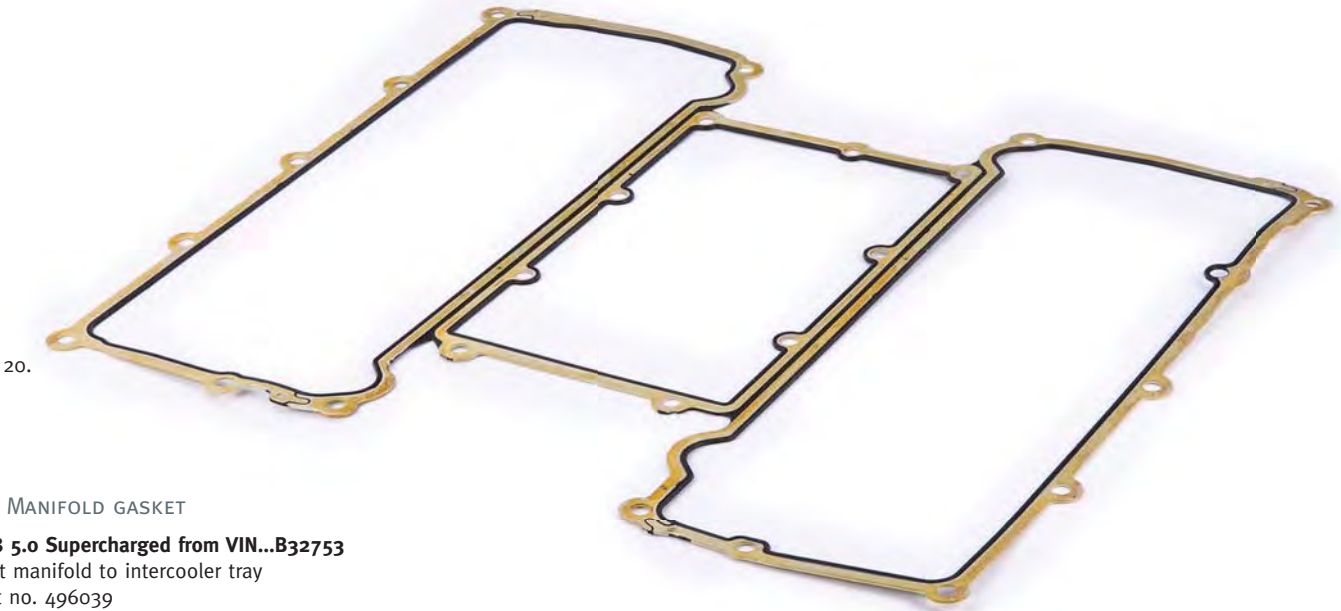

20.

20. MANIFOLD GASKET

XK8 5.0 Supercharged from VIN...B32753
inlet manifold to intercooler tray
Part no. 496039

21. MANIFOLD GASKET

intercooler tray to cylinder head

XK8 5.0 Supercharged from VIN...B32753
to LH cylinder head (B' bank) . . Part no. 496037
to RH cylinder head (A' bank) . . Part no. 496038



21.

22. MANIFOLD GASKET

exhaust manifold to cylinder head

XK8 4.0 and 4.2 to VIN...A48684
to LH cylinder head (B' bank) . . Part no. 435090
to RH cylinder head (A' bank) . . Part no. 435089

XK8 3.5 and 4.2 from VIN...Boo379 to B32752
to LH cylinder head (B' bank) . . Part no. 495647
to RH cylinder head (A' bank) . . Part no. 495648

XK8 5.0 from VIN...B32753
to LH cylinder head (B' bank) . . Part no. 496041
to RH cylinder head (A' bank) . . Part no. 496040



22.

1. FUEL PUMP, FUEL FILTER AND SENDER UNIT

1. FUEL FILTER

Reproduction

XK8 4.0 to VIN...A30644
Part no. 319649

Original Jaguar

XK8 4.0 to VIN...A30644
Part no. 286301

XK8 4.2 from VIN...A30645 to A48684
Part no. 495412

XK8 3.5 and 4.2 from VIN...B00379 to B32752,
XK8 5.0 from VIN...B32753
Part no. 495174



Original

Reproduction



2. 'O' RING

fuel filter



XK8 4.0 to VIN...A30644

Qty. required: 2 Part no. 471727

3. FUEL FILLER CAP

XK8 4.0 to VIN...A11050
Part no. 257484

XK8 4.0 from VIN...A11051 to A30644,
XK8 4.2 from VIN...A30645 to A48684
Part no. 435797

XK8 3.5 and 4.2 from VIN...B00379 to B18460
Part no. 489809

XK8 3.5 and 4.2 from VIN...B18461 to B32752,
XK8 5.0 from B32753
Part no. 496049



3.

4. FUEL PUMP

less filter

XK8 4.0 except Supercharged to VIN...A30644
Original Part no. 487122
Reproduction Part no. 491431



XK8 4.0 Supercharged to VIN...A30644
Qty. required: 2
Original Part no. 487122
Reproduction Part no. 491431



5. FILTER

inside fuel pump

XK8 4.0 to VIN...A30644
Qty. required: 2 Part no. 435671



1. FUEL PUMP, FUEL FILTER AND SENDER UNIT

6. FUEL SENDER UNIT

XK8 4.0 to VIN...A30644
Part no. 425254

7. SEALING RUBBER

fuel sender unit

XK8 4.0 to VIN...A30644
Part no. 747



8. FUEL PUMP

conveyor module inside the tank

XK8 4.2 except Supercharged from VIN...A30645 to A48684
Part no. 495490

XK8 4.2 Supercharged from VIN...A30645 to A48684
Part no. 495491

XK8 4.2 Supercharged from VIN...B00379 to B32752
Part no. 496051

XK8 3.5 and 4.2 except Supercharged from VIN...B00379 to B09083
Part no. 496052

XK8 3.5 and 4.2 except Supercharged from VIN...B09084 to B32752
Part no. 496053

XK8 5.0 from VIN...B32753
Part no. 496054



9. GASKET

between fuel pump module and mounting flange

XK8 3.5 and 4.2 from VIN...B00379 to B32752, XK8 5.0 from VIN...B32753
Part no. 496055



10. SEALING RING

evaporative loss flange to tank

XK8 4.0 and 4.2 to VIN...A48684
Part no. 286418



11. RETAINING CLIP

fuel pipe to underbody

XK8 4.0 and 4.2 to VIN...A48684
Qty. required: 3 Part no. 281493



12. WAGNER ADDITIVE

Bactofin - fuel stabilizer, special for fuels with Bio-Ethanol (E10). Dosage: 1:1000

Modern fuels attack the metal parts of the fuel supply systems. This problem applies especially to older vehicles, while in modern cars, for good reasons, more and more plastic tanks are used. The second problem relates to biogenic fuels and mixed fuels. This problem applies to owners of all ages of cars and modern cars too. In modern fuels bacteria grow in unprecedented quantities. This produces a lot of dirt, especially when the vehicle is not in regular use. The pipes gradually get blocked and the tank becomes contaminated with dirt. Rather than the drastic measure of replacing the entire fuel supply system, regular use of Bactofin will reduce the problem considerably. For vehicles which normally operate with lead-replacement or top oil, using Bactofin is just as easy and will give owners peace of mind. Bactofin also prevents any corrosion of the fuel system. Rust is completely inhibited!

100 ml. Part no. 494084
300 ml. Part no. 494085
1 litre. Part no. 494086



1. SHOCK ABSORBER, WISHBONES AND BALL JOINTS - TO 2005 MY

XK8 4.0 AND 4.2 TO VIN...A48684

1. WISHBONE

with ball joint and bushes assembly

XK8 4.0 and 4.2 to VIN...A48684

LH upper Part no. 423009

RH upper Part no. 423008



2. BALL JOINT

upper wishbone

XK8 4.0 and 4.2 to VIN...A48684

Qty. required: 2 Part no. 283986

3. BUSH

upper wishbone

XK8 4.0 and 4.2 to VIN...A48684

Qty. required: 4 Part no. 347695

4. BOLT

upper wishbone to front subframe

XK8 4.0 and 4.2 to VIN...A48684

Qty. required: 2 Part no. 433284

5. TAPTITE NUT

ball joint an wishbone bolt

XK8 4.0 and 4.2 to VIN...A48684

Qty. required: 4 Part no. 273342



6. WISHBONE

with ball joint and bush assembly

XK8 4.0 and 4.2 to VIN...A48684

LH rear lower Part no. 422946

RH rear lower Part no. 422945



7. WISHBONE

lower front, with bush assembly

XK8 4.0 and 4.2 to VIN...A48684

Qty. required: 2 Part no. 433273



1. SHOCK ABSORBER, WISHBONES AND BALL JOINTS - TO 2005 MY

XK8 4.0 AND 4.2 TO VIN...A48684

Insider tip 

Please note: The wishbone bushes 355125 and 356311 must always be replaced together

8. BALL JOINT

lower wishbone

XK8 4.0 and 4.2 to VIN...A48684

Qty. required: 2 Part no. 356329

9. BUSH

rear lower wishbone

XK8 4.0 and 4.2 to VIN...A48684

Qty. required: 2 Part no. 355125

10. BUSH

front lower wishbone

XK8 4.0 and 4.2 to VIN...A48684

Qty. required: 2 Part no. 356311

11. BOLT

lower wishbone to front subframe

XK8 4.0 and 4.2 to VIN...A48684

Qty. required: 2 Part no. 281263

12. TAPTITE NUT

ball joint and wishbone bolt

XK8 4.0 and 4.2 to VIN...A48684

Qty. required: 4 Part no. 273342

13. HUB CARRIER

XK8 4.0 to VIN...031302

including larger 80 mm wheel bearing and anti roll bar link

LH. Part no. 422553

RH. Part no. 422554

XK8 4.0 and 4.2 except ,R' performance options from VIN...031303 to A48684

LH. Part no. 434205

RH. Part no. 434204

XK8 4.0 with ,R' performance options from VIN...A00083 to A22190

LH. Part no. 434691

RH. Part no. 434689

XK8 4.0 and 4.2 with ,R' performance options from VIN...A22191 to A48684

LH. Part no. 434690

RH. Part no. 434692



13.

1. SHOCK ABSORBER, WISHBONES AND BALL JOINTS - TO 2005 MY

XK8 4.0 AND 4.2 TO VIN...A48684

14. WHEEL BEARING

with 76 mm outer diameter

XK8 4.0 to VIN...031302

Qty. required: 2 Part no. 283990

with 80 mm outer diameter

XK8 4.0 and 4.2 from VIN...031303 to A48684

Qty. required: 2 Part no. 356295

15. CIRCLIP

for wheel bearing with 76 mm outer diameter

XK8 4.0 to VIN...031302

Qty. required: 4 Part no. 487802

for wheel bearing with 80 mm outer diameter

XK8 4.0 and 4.2 from VIN...031303 to A48684

Qty. required: 4 Part no. 487803

16. LOCK PLATE

for wheel bearing

XK8 4.0 and 4.2 to VIN...A48684

Qty. required: 2 Part no. 433299

17. TIMING ROTOR

ABS sensor

XK8 4.0 and 4.2 to VIN...A48684

Qty. required: 2 Part no. 283992



14.



15.



16.



17.

18. WHEEL STUD

XK8 4.0 to VIN...008233

Qty. required: 10 Part no. 246661

XK8 4.0 and 4.2 from VIN...008234 to A48684

Qty. required: 10 Part no. 281257



19. SHOCK ABSORBER

All XK8 4.0 and 4.2 to VIN...A48684 except adaptive control damping (C.A.T.S) and ,R' performance options (Brembo brakes)

Qty. required: 2 Part no. 356337

XK8 4.0 with adaptive control damping (C.A.T.S) to VIN...024686

Qty. required: 2 Part no. 433313

XK8 4.0 with adaptive control damping (C.A.T.S) from VIN...024687 to 042775

Qty. required: 2 Part no. 433655

XK8 4.0 with adaptive control damping (C.A.T.S) and ,R' performance options (Brembo brakes) from VIN...A00083 to A30644

Qty. required: 2 Part no. 434698

XK8 4.0 with adaptive control damping (C.A.T.S) except models with ,R' performance options (Brembo brakes) from VIN...A00083 to A30644

Qty. required: 2 Part no. 433655

XK8 4.2 with adaptive control damping (C.A.T.S) except models with ,R' performance options (Brembo brakes) from VIN...A30645 to A48684

Qty. required: 2 Part no. 494738

XK8 4.2 with ,R' performance options (Brembo brakes) from VIN...A30645 to A48684

Qty. required: 2 Part no. 494739



19.

1. SHOCK ABSORBER, WISHBONES AND BALL JOINTS - TO 2005 MY

XK8 4.0 AND 4.2 TO VIN...A48684

20. BUSH

shock absorber lower

XK8 4.0 and 4.2 to VIN...A48684

Qty. required: 2 Part no. 433320

21. BOLT

shock absorber lower

XK8 4.0 and 4.2 to VIN...A48684

Qty. required: 2 Part no. 272826

22. NYLOC NUT

shock absorber lower

XK8 4.0 and 4.2 to VIN...A48684

Qty. required: 2 Part no. 215359



23. SPRING AND DAMPER MOUNTING

XK8 4.0 and 4.2 to VIN...A48684

Qty. required: 2 Part no. 433334

24. ISOLATOR BUFFER

shock absorber

XK8 4.0 and 4.2 to VIN...A48684

Qty. required: 2 Part no. 433318



25. DUST SEAL

shock absorber

XK8 4.0 and 4.2 to VIN...A48684

Qty. required: 2 Part no. 284002

26. SPRING COLLAR

front coil spring

XK8 4.0 and 4.2 to VIN...A48684

Qty. required: 2 Part no. 433332



27. COIL SPRINGS

front suspension - supplied in pairs

All XK8 4.0 Coupe to VIN...A30644 except supercharged, adaptive control damping (C.A.T.S) and ,R' performance options (Brembo brakes)
Part no. 422383

All XK8 4.0 Convertible to VIN...A30644 except supercharged, adaptive control damping (C.A.T.S) and ,R' performance options (Brembo brakes)
Part no. 422384

All XK8 4.0 Convertible to VIN...A30644 except ,R' performance options (Brembo brakes)
Part no. 422379

All XK8 4.0 supercharged Coupe with adaptive control damping (C.A.T.S) and ,R' performance options (Brembo brakes) from VIN...A00083 to A30644
Part no. 422910

All XK8 4.0 supercharged Coupe with adaptive control damping (C.A.T.S) but without ,R' performance options (Brembo brakes) to VIN...A30644
Part no. 422365

All XK8 4.0 non supercharged Coupe with adaptive control damping (C.A.T.S) and ,R' performance options (Brembo brakes) from VIN...A00083 to A30644
Part no. 422911

XK8 4.2 Convertible from VIN...A30645 to A48684
Part no. 422379

All XK8 4.2 Coupe with ,R' performance options (Brembo brakes) from VIN...A30645 to A48684
Part no. 422910

All XK8 4.2 Coupe except ,R' performance options (Brembo brakes) from VIN...A30645 to A48684
Part no. 422365



1. SHOCK ABSORBER, WISHBONES AND BALL JOINTS - TO 2005 MY

XK8 4.0 AND 4.2 TO VIN...A48684

28. ANTI ROLL BAR LINK

XK8 4.0 and 4.2 to VIN...A48684

Qty. required: 2 Part no. 433310

29. RUBBER BUSH

anti roll bar

XK8 4.0 and 4.2 except ,R' performance options (Brembo brakes) to VIN...A48684

Qty. required: 2 Part no. 283997

XK8 4.0 and 4.2 with ,R' performance options (Brembo brakes) from VIN...A00083 to A48684

Qty. required: 2 Part no. 434697

30. SPECIAL GREASE

for bushes

5 gram. Part no. 312158



28.



29.



30.

31. PACKING PIECE

below coil spring

XK8 4.0 and 4.2 to VIN...A48684

Qty. required: 2 Part no. 433322

32. BUSH

subframe to chassis - front fixing

XK8 4.0 and 4.2 to VIN...A48684

Qty. required: 2 Part no. 433345

33. MOUNTING

subframe to chassis - rear fixing

XK8 4.0 and 4.2 to VIN...A48684

Qty. required: 2 Part no. 433343



31.



32.



33.

34. POLYURETHANE BUSH KIT

front suspension

XK8 4.0 and 4.2 to VIN...A48684

Part no. 493936

Polyurethane bushes give improved suspension support with a greater wear resistance compared to their rubber equivalents. They are naturally self-lubricating. A worthwhile addition to any car, the polyethylene bushes are supplied individually, with a steel sleeve where necessary.



2. SHOCK ABSORBER, WISHBONES AND BALL JOINTS - FROM 2006 MY

XK8 3.5 AND 4.2 FROM VIN...B00379, XK8 5.0 FROM VIN...B32753

1. WISHBONE

with ball joint and bushes assembly

**XK8 3.5 and 4.2 from VIN...B00379,
XK8 5.0 from VIN...B32753**

LH upper Part no. 494839
RH upper Part no. 494840



1.

2. BOLT

upper wishbone to front subframe

**XK8 3.5 and 4.2 from VIN...B00379,
XK8 5.0 from VIN...B32753**

Qty. required: 4 Part no. 496101



2.



3.

3. TAPTITE NUT

upper wishbone to front subframe

**XK8 3.5 and 4.2 from VIN...B00379,
XK8 5.0 from VIN...B32753**

Qty. required: 4 Part no. 496102

4. WISHBONE

with bushes assembly

**XK8 3.5 and 4.2 from VIN...B00379, XK8 5.0
from VIN...B32753**

LH rear lower Part no. 494841
RH rear lower Part no. 494842



4.

5. BUSH

rear lower wishbone - inner

**XK8 3.5 and 4.2 from VIN...B00379,
XK8 5.0 from VIN...B32753**

Qty. required: 2 Part no. 494846



5.



6.

6. BUSH

rear lower wishbone - outer

**XK8 3.5 and 4.2 from VIN...B00379,
XK8 5.0 from VIN...B32753**

Qty. required: 2 Part no. 494847

7. WISHBONE

lower front, with bushes assembly

XK8 3.5 and 4.2 from VIN...B00379 to B32752

Qty. required: 2 Part no. 494843

XK8 5.0 from VIN...B32753

Qty. required: 2 Part no. 494844



7.

2. SHOCK ABSORBER, WISHBONES AND BALL JOINTS - FROM 2006 MY

XK8 3.5 AND 4.2 FROM VIN...B00379, XK8 5.0 FROM VIN...B32753



8.

8. STUB AXLE

XK8 3.5 and 4.2 from VIN...B00379 to B32752

LH. Part no. 494855

RH. Part no. 494859

XK8 5.0 from VIN...B32753

LH. Part no. 494869

RH. Part no. 494871

9. HUB

with wheel bearing and ABS sensor assembly

XK8 3.5 and 4.2 from VIN...B00379 to B32752

Qty. required: 2 Part no. 494837

XK8 5.0 from VIN...B32753

Qty. required: 2 Part no. 494838



9.

10. SHOCK ABSORBER

XK8 3.5 and 4.2 non supercharged models without adaptive control damping (C.A.T.S) from VIN...B00379 to B32752

Qty. required: 2 Part no. 494742

XK8 3.5 and 4.2 non supercharged models with adaptive control damping (C.A.T.S) from VIN...B00379 to B32752

Qty. required: 2 Part no. 494741

XK8 4.2 Supercharged except XKR-S models from VIN...B00379 to B32752

Qty. required: 2 Part no. 494740

XKR-S 4.2 Supercharged from VIN...B00379 to B32752

Qty. required: 2 Part no. 490001

XK8 5.0 from VIN...B32753 to B44939 except Goodwood LE and XKR-S models

identify by green marking

Qty. required: 2 Part no. 494743

XK8 5.0 from VIN...B32753 to B44939 except Goodwood LE and XKR-S models

identify by purple marking

Qty. required: 2 Part no. 494744

XK8 5.0 from VIN...B44940 except Goodwood LE and XKR-S models

Qty. required: 2 Part no. 495804

XK8 5.0 Goodwood LE and XKR-S models from VIN...B32753

Qty. required: 2 Part no. 494745



10.

11. BOLT

shock absorber to lower wishbone

XK8 3.5 and 4.2 von VIN...B00379 to B32752, XK8 5.0 from VIN...B32753

Qty. required: 2 Part no. 440616

12. BUSH

shock absorber, lower fixing

XK8 3.5 and 4.2 from VIN...B00379 to B32752, XK8 5.0 from VIN...B32753

Qty. required: 2 Part no. 494845



11.



12.

2. SHOCK ABSORBER, WISHBONES AND BALL JOINTS - FROM 2006 MY

XK8 3.5 AND 4.2 FROM VIN...B00379, XK8 5.0 FROM VIN...B32753

13. COIL SPRING

XKR-S 4.2 Supercharged from VIN...B00379 to B32752

Qty. required: 2 Part no. 496108

XK8 4.2 Supercharged except XKR-S models from VIN...B00379 to B32752

Qty. required: 2 Part no. 496109

XK8 3.5 and 4.2 except Supercharged from VIN...B00379 to B32752

Qty. required: 2 Part no. 496110

XK8 5.0 from VIN...B32753 except Supercharged, Goodwood LE and XKR-S models

Qty. required: 2 Part no. 496111

XK8 5.0 Supercharged from VIN...B32753 except Goodwood LE and XKR-S models

Qty. required: 2 Part no. 496112

XK8 5.0 Goodwood LE and XKR-S models from VIN...B32753

Qty. required: 2 Part no. 496113



13.

17. RUBBER BUSH

anti roll bar

XK8 3.5 and 4.2 from VIN...B00379 to B32752

Qty. required: 2 Part no. 438791

XK8 5.0 from VIN...B32753

Qty. required: 2 Part no. 494834

18. ANTI ROLL BAR LINK

XK8 3.5 and 4.2 from VIN...B00379 to B32752,

XK8 5.0 from VIN...B32753

Qty. required: 2 Part no. 441783



17.



18.

14. DUST SEAL

shock absorber

XK8 3.5 and 4.2 from VIN...B00379 to B32752,

XK8 5.0 from VIN...B32753

Qty. required: 2 Part no. 496114

15. INSULATOR

coil spring

XK8 3.5 and 4.2 from VIN...B00379 to B32752,

XK8 5.0 from VIN...B32753

Qty. required: 2 Part no. 496115



14.

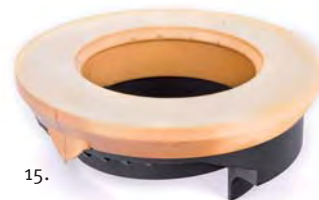

15.

16. PACKING PIECE

below coil spring

XK8 3.5 and 4.2 from VIN...B00379 to B32752,

XK8 5.0 from VIN...B32753

Qty. required: 2 Part no. 433322



16.

1. EXHAUST SYSTEMS AND GASKETS - TO 2005 MY

XK8 4.0 AND 4.2 TO VIN...A48684

1. MANIFOLD GASKET

exhaust manifold to cylinder head

XK8 4.0 and 4.2 to VIN...A48684to LH cylinder head (B' bank) . . Part no. 435090
to RH cylinder head (A' bank) . . Part no. 435089

2. GASKET

catalytic converter to exhaust manifold

XK8 4.0 and 4.2 to VIN...A48684

Qty. required: 2 Part no. 256258

3. STUD

catalytic converter to exhaust manifold

XK8 4.0 and 4.2 to VIN...A48684

Qty. required: 8 Part no. 424721

4. TAPTITE NUT

catalytic converter to exhaust manifold

XK8 4.0 and 4.2 to VIN...A48684

Qty. required: 8 Part no. 424773



5. GASKET

exhaust to catalytic converter

XK8 4.0 to VIN...A30644

Qty. required: 2 Part no. 436188

XK8 4.2 from VIN...A30645 to A48684

Qty. required: 2 Part no. 495511

6. STUD

exhaust to catalytic converter

XK8 4.2 from VIN...A30645 to A48684

Qty. required: 4 Part no. 495514

7. TAPTITE NUT

exhaust to catalytic converter

XK8 4.0 and 4.2 to VIN...A48684

Qty. required: 4 Part no. 370545



8. LAMBDA OXYGEN SENSOR

heated, fitted in front of the catalytic converter

XK8 4.0 with OBD II interface except Supercharged to VIN...031302, XK8 4.0 Supercharged to VIN...042775

Qty. required: 2 Part no. 282083

XK8 4.0 with OBD II interface except Supercharged from VIN...031303 to A30644, XK8 4.0 Supercharged from VIN...042775 to A30644

Qty. required: 2 Part no. 431315

XK8 4.2 from VIN...A30645 to A48684

Qty. required: 2 Part no. 491883

1. EXHAUST SYSTEMS AND GASKETS - TO 2005 MY

XK8 4.0 AND 4.2 TO VIN...A48684



9. LAMBDA OXYGEN SENSOR

heated, fitted behind of the catalytic converter

XK8 4.0 from VIN...031303 to A30644

Qty. required: 2 Part no. 431313

XK8 4.2 from VIN...A30645 to A48684

Qty. required: 2 Part no. 495326

10. FRONT SILENCER

XK8 4.0 except Supercharged to VIN...A30644

Part no. 435846

XK8 4.0 Supercharged to VIN...A30644

Part no. 435845

XK8 4.2 except Supercharged from VIN...A30645 to A48684

Part no. 495507

XK8 4.2 Supercharged from VIN...A30645 to A48684

Part no. 495508

11. CENTRE SILENCER

XK8 4.0 to VIN...A30644

LH. Part no. 435702

RH. Part no. 435699

XK8 4.2 from VIN...A30645 to A48684

LH. Part no. 495496

RH. Part no. 495497



11.



10.

Fittings for front and centre silencers

12. EXHAUST CLAMP

between front silencer and catalytic converter, made from stainless steel

XK8 4.0 to VIN...A30644

Qty. required: 2 Part no. 208963

13. EXHAUST MOUNTING RUBBER

centre silencer

XK8 4.0 and 4.2 to VIN...A48684

Qty. required: 2 Part no. 389660

14. EXHAUST CLAMP

between centre and front silencer, made from stainless steel

XK8 4.0 and 4.2 to VIN...A48684

Qty. required: 2 Part no. 208963



12.



13.



14.

1. EXHAUST SYSTEMS AND GASKETS - TO 2005 MY

XK8 4.0 AND 4.2 TO VIN...A48684

15. REAR SILENCER

complete with tail pipe finisher in polished stainless steel

XK8 4.0 except Supercharged to VIN...A11050LH. Part no. 435786
RH. Part no. 435785**XK8 4.0 except Supercharged from VIN...A11051, XK8 4.2 except Supercharged to VIN...A40264**LH. Part no. 435806
RH. Part no. 435803**XK8 4.0 Supercharged to VIN...A11050**LH. Part no. 435804
RH. Part no. 435802**XK8 4.0 Supercharged from VIN...A11051 to A30644**LH. Part no. 435851
RH. Part no. 435850**XK8 4.2 Supercharged from VIN...A30645 to A40264**LH. Part no. 495498
RH. Part no. 495499**XK8 4.2 from VIN...A40265 to A48684**LH. Part no. 495502
RH. Part no. 495501

Fittings for rear silencer

16. EXHAUST MOUNTING RUBBER

rear silencer

XK8 4.0 to VIN...A30644

Qty. required: 2 Part no. 286238

XK8 4.0 from VIN...A11051, XK8 4.2 to VIN...A40264

Qty. required: 2 Part no. 389660

XK8 4.2 from VIN...A40265 to A48684

Qty. required: 2 Part no. 495506

17. EXHAUST BRACKET

rear silencer

XK8 4.0 to VIN...A30644

Qty. required: 2 Part no. 435601

XK8 4.0 from VIN...A11051, XK8 4.2 to VIN...A40264

LH rear silencer Part no. 435808

RH rear silencer Part no. 435807

XK8 4.2 von VIN...A40265 bis A48684

Qty. required: 2 Part no. 495621

18. EXHAUST CLAMP

between centre and rear silencer, made from stainless steel

XK8 4.0 and 4.2 to VIN...A48684

Qty. required: 2 Part no. 208963



19. TAIL PIPE FINISHER

made from polished stainless steel

XK8 4.0 Supercharged from VIN...A11051 to A30644

Qty. required: 2 Part no. 436167

XK8 4.2 Supercharged from VIN...A30645 to A40265

Qty. required: 2 Part no. 495500

XK8 4.2 Supercharged from VIN...A40265 to A48684

LH. Part no. 495505

RH. Part no. 495504

XK8 4.2 except Supercharged from VIN...A40265 to A48684

Qty. required: 2 Part no. 495503



20. EXHAUST SYSTEM

made from stainless steel. Big bore variant for the CATs back with polished stainless tail trims

XK8 4.0 and 4.2 to VIN...A48684

Part no. 495535

This system includes front, center and rear sport silencers. Due to the enlargement of the cross section of the tube as well as a significantly reduced exhaust back pressure, this stainless steel system offers you a power increase of approx. 15 HP. The system underscores the sportive character by means of a typical V8-sound spectrum.

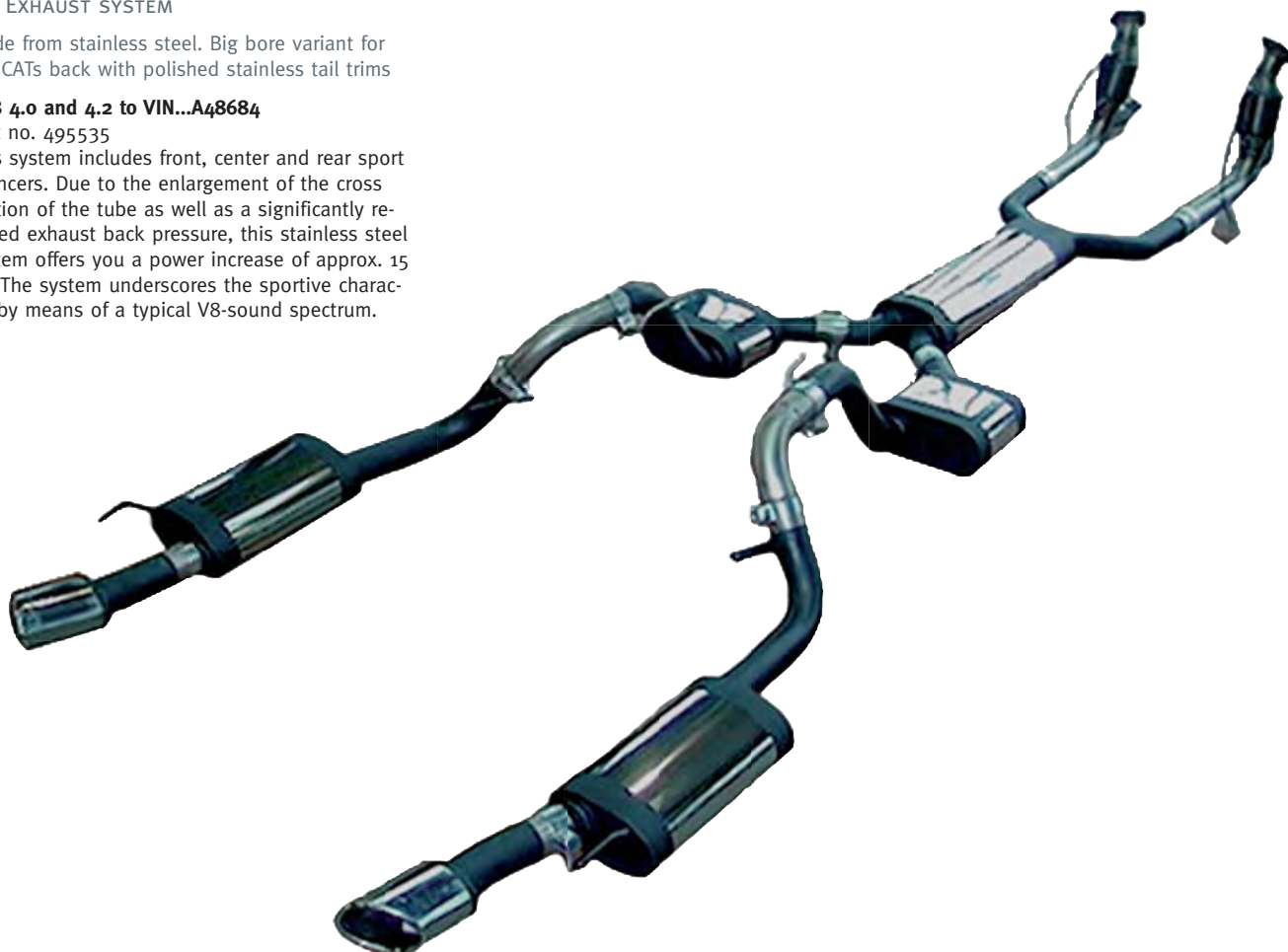

Fittings for big bore exhaust

21. EXHAUST BRACKET

XK8 4.0 and 4.2 to VIN...A48684

Qty. required: 2 Part no. 435601

22. EXHAUST MOUNTING RUBBER

XK8 4.0 and 4.2 to VIN...A48684

Qty. required: 2 Part no. 286238



2. EXHAUST SYSTEMS AND GASKETS - FROM 2006 MY

XK8 3.5 AND 4.2 FROM VIN...B00379, XK8 5.0 FROM VIN...B32753

1. MANIFOLD GASKET

exhaust manifold to cylinder head

XK8 3.5 and 4.2 from VIN...B00379 to B32752
to LH cylinder head (B' bank) . . Part no. 495647
to RH cylinder head (A' bank) . . Part no. 495648

XK8 5.0 from VIN...B32753
to LH cylinder head (B' bank) . . Part no. 496041
to RH cylinder head (A' bank) . . Part no. 496040



2. STUD

catalytic converter to exhaust manifold

XK8 3.5 and 4.2 from VIN...B00379, XK8 5.0 from VIN...B32753
Qty. required: 4 Part no. 437220

3. TAPTITE NUT

catalytic converter to exhaust manifold

XK8 3.5 and 4.2 from VIN...B00379, XK8 5.0 from VIN...B32753
Qty. required: 4 Part no. 437219



4. LAMBDA OXYGEN SENSOR

heated, fitted in front of the catalytic converter

XK8 3.5 and 4.2 from VIN...B00379 to B32752
Qty. required: 2 Part no. 493770

XK8 5.0 from VIN...B32753
Qty. required: 2 Part no. 495327

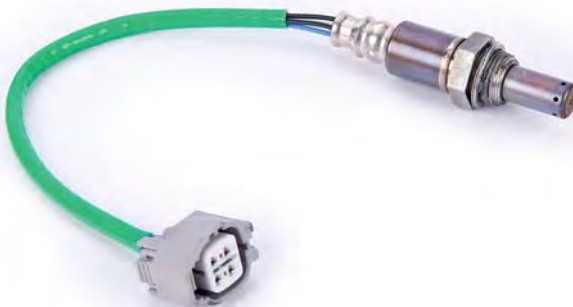

5. LAMBDA OXYGEN SENSOR

heated, fitted behind of the catalytic converter

XK8 3.5 and 4.2 from VIN...B00379 to B32752
Qty. required: 2 Part no. 495329

XK8 5.0 from VIN...B32753
Qty. required: 2 Part no. 495328



2. EXHAUST SYSTEMS AND GASKETS - FROM 2006 MY

XK8 3.5 AND 4.2 FROM VIN...B00379, XK8 5.0 FROM VIN...B32753

6. REAR SILENCER

complete with tail pipe finishers in polished stainless steel

XK8 3.5 and 4.2 except Supercharged from VIN...B00379 to B32752
Part no. 496120

XK8 4.2 Supercharged from VIN...B00379 to B32752
Part no. 496125

XK8 5.0 Goodwood LE and XKR-S from VIN...B32753
Part no. 496127

XK8 5.0 except Supercharged from VIN...B32753
Part no. 496121

XK8 5.0 Supercharged except Goodwood LE and XKR-S from VIN...B32753
Part no. 496126



Fittings for rear silencer

7. EXHAUST MOUNTING RUBBER

rear silencer, rear fixing

XK8 3.5 and 4.2 from VIN...B00379 to B32752
Qty. required: 2 Part no. 496122

XK8 5.0 except XKR-S from VIN...B32753
Qty. required: 2 Part no. 496123

8. EXHAUST MOUNTING RUBBER

rear silencer, front fixing

XK8 3.5 and 4.2 from VIN...B00379 to B32752,
XK8 5.0 from VIN...B32753
Part no. 496124

9. EXHAUST MOUNTING RUBBER

centre silencer

XK8 3.5 and 4.2 from VIN...B00379 to B32752,
XK8 5.0 from VIN...B32753
Qty. required: 2 Part no. 444410



1. TRACK ROD ENDS, STEERING RACK, PUMP AND GAITERS - TO 2005 MY

XK8 4.0 AND 4.2 TO VIN...A48684

1. TRACK ROD END

XK8 4.0 and 4.2 to VIN...A48684

Qty. required: 2 Part no. 17261



2. STEERING RACK GAITERS

supplied in pairs

Part no. 422359



3. HOSE CLIP

steering rack gaiter - 64 mm

Qty. required: 2 Part no. 422360

4. HOSE CLIP

steering rack gaiter - 13 mm

Qty. required: 2 Part no. 422361



5. POWER STEERING UNIT

exchange

XK8 4.0 except Supercharged to VIN...018107

LHD models only Part no. 433373

XK8 4.0 except Supercharged from VIN...018108 to 031302

LHD models only Part no. 434290

XK8 4.0 and 4.2 Supercharged without adaptive control damping (C.A.T.S) and ,R' performance options (Brembo brakes) from VIN...031303 to A48684

LHD models only Part no. 485047

XK8 4.0 and 4.2 with adaptive control damping (C.A.T.S) or ,R' performance options (Brembo brakes) from VIN...031303 to A48684

LHD models only Part no. 434716

XK8 4.0 and 4.2 without adaptive control damping (C.A.T.S) and ,R' performance options (Brembo brakes) from VIN...024687 to A48684

RHD models only Part no. 433767

XK8 4.0 and 4.2 with adaptive control damping (C.A.T.S) and ,R' performance options (Brembo brakes) from VIN...A00083 to A48684

RHD models only Part no. 434714



1. TRACK ROD ENDS, STEERING RACK, PUMP AND GAITERS - TO 2005 MY

XK8 4.0 AND 4.2 TO VIN...A48684

6. BUSH

steering rack mounting - driver side

XK8 4.0 and 4.2 without ,R' performance options (Brebo brakes) to VIN...A48684
Part no. 356331

XK8 4.0 and 4.2 with ,R' performance options (Brebo brakes) to VIN...A48684
Part no. 434718



7. BUSH

steering rack mounting - passenger side

XK8 4.0 and 4.2 without ,R' performance options (Brebo brakes) to VIN...A48684
Part no. 356330

XK8 4.0 and 4.2 with ,R' performance options (Brebo brakes) to VIN...A48684
Part no. 434719



8. STEERING PUMP

exchange

XK8 4.0 to VIN...A30644
Part no. 433645

XK8 4.2 from VIN...A30645 to A48684
Part no. 495522



9. HYDRAULIC RESERVOIR

XK8 4.0 and 4.2 to VIN...A48684
power steering, with filler cap assembly
Part no. 284042



10. HYDRAULIC PIPES

power steering rack - supplied in pairs

XK8 4.0 and 4.2 except Supercharged from VIN...031303 to A48684, XK8 4.0 and 4.2 Supercharged from VIN...024695 to A48684
LHD models only Part no. 423194
RHD models only Part no. 423195



11. STEERING COLUMN

lower

XK8 4.0 and 4.2 to VIN...A48684
LHD models Part no. 413739
RHD models Part no. 413737



12. CASTROL OIL

Transmax Dex III for power steering units - replaces TQ Dexron III

Transmax Dex III is a high quality mineral based fluid, recommended for most passenger cars where a product to GM Dexron III, Ford Mercon 94 or Allison C4 is recommended.
XK8 4.0 and 4.2 to VIN...A48684
1 litre bottle
Part no. 217068



2. TRACK ROD ENDS, STEERING PUMP AND GAITERS - FROM 2006 MY

XK8 3.5 AND 4.2 FROM VIN...B00379, XK8 5.0 FROM VIN...B32753

1. TRACK ROD END

XK8 3.5 and 4.2 from VIN...B00379 to B32752 and all XKR-S models

LH. Part no. 487136
RH. Part no. 487137

XK8 5.0 except XKR-S models from VIN...B32753

LH. Part no. 496146
RH. Part no. 496147



1.

2. BUSH

steering rack mounting, upper

XK8 3.5 and 4.2 from VIN...B00379 to B32752, XK8 5.0 from VIN...B32753

Qty. required: 2 Part no. 496148

3. BUSH

steering rack mounting, lower

XK8 3.5 and 4.2 from VIN...B00379 to B32752, XK8 5.0 from VIN...B32753

Qty. required: 2 Part no. 487018



2.

3.

9. UNIVERSAL JOINT

steering column, lower

XK8 3.5 and 4.2 except XKR-S models from VIN...B00379 to B32752, XK8 5.0 except XKR-S models from VIN...B32753

LHD models only Part no. 496156
RHD models only Part no. 496158

XK8 4.2 XKR-S models from VIN...B00379 to B32752, XK8 5.0 XKR-S models from VIN...B32753

LHD models only Part no. 496155
RHD models only Part no. 496157



4. STEERING RACK GAITER

driver side

XK8 3.5 and 4.2 from VIN...B00379 to B32752, XK8 5.0 from VIN...B32753

Part no. 496149



4.

5. STEERING RACK GAITER

passenger side

XK8 3.5 and 4.2 from VIN...B00379 to B32752, XK8 5.0 from VIN...B32753

Part no. 496150



5.

6. HOSE CLIP

steering rack gaiter, outer - 16 mm

XK8 3.5 and 4.2 from VIN...B00379 to B32752, XK8 5.0 from VIN...B32753

Qty. required: 2 Part no. 444054

7. HOSE CLIP

steering rack gaiter, inner - 66 mm

XK8 3.5 and 4.2 from VIN...B00379 to B32752, XK8 5.0 from VIN...B32753

Qty. required: 2 Part no. 443953



6.



7.

8. STEERING PUMP

exchange item

XK8 3.5 and 4.2 from VIN...B00379 to B32752
Part no. 495522

new item

XK8 5.0 from VIN...B32753
Part no. 496151



10. FILLER CAP

power steering reservoir

XK8 3.5 and 4.2 from VIN...B00379 to B32752, XK8 5.0 from VIN...B32753

Part no. 496159



11. CASTROL OIL

Transmax Dex III for power steering units
replaces TQ Dexron III

Transmax Dex III is a high quality mineral based fluid, recommended for most passenger cars where a product to GM Dexron III, Ford Mercon 94 or Allison C4 is recommended.

XK8 4.0 and 4.2 to VIN...A48684

1 litre bottle
Part no. 217068



1. SHOCK ABSORBER, WISHBONES AND COIL SPRINGS - TO 2005 MY

XK8 4.0 AND 4.2 TO VIN...A48684

1. SHOCK ABSORBER

All XK8 4.0 and 4.2 to VIN...A48684 except adaptive control damping (C.A.T.S) and ,R' performance options (Brembo brakes)

Qty. required: 2 Part no. 480859

XK8 4.0 and 4.2 with adaptive control damping (C.A.T.S) to VIN...A48684 except ,R' performance options (Brembo brakes)

Qty. required: 2 Part no. 433656

XK8 4.0 and 4.2 with adaptive control damping (C.A.T.S) and ,R' performance options (Brembo brakes) to VIN...A48684

Qty. required: 2 Part no. 434710



2. CONNECTING HARNESS

shock absorber

XK8 4.0 and 4.2 with adaptive control damping (C.A.T.S) to VIN...A48684

Qty. required: 2 Part no. 495088



XK8 4.0 and 4.2 to VIN...A48684

Shock absorber, bottom

3. BUSH

Qty. required: 2 Part no. 486964

4. BOLT

Qty. required: 2 Part no. 281244

5. PLAIN WASHER

Qty. required: 2 Part no. 281424

6. NUT

Qty. required: 2 Part no. 280811

7. BUSH

identify by 68 mm outer diameter

Qty. required: 2 Part no. 247549

Shock absorber, top

8. BUSH

identify by 50 mm outer diameter

Qty. required: 2 Part no. 247548



9. COIL SPRINGS

rear suspension - supplied in pairs

XK8 4.0 with adaptive control damping (C.A.T.S) to VIN...019724

Part no. 421867

XK8 4.0 with adaptive control damping (C.A.T.S) except ,R' performance options (Brembo brakes) from VIN...019725 to A30644

Part no. 422295

XK8 4.0 with adaptive control damping (C.A.T.S) and ,R' performance options (Brembo brakes) from VIN...A00083 to A30644

Part no. 422912

XK8 4.0 without adaptive control damping (C.A.T.S) or ,R' performance options (Brembo brakes) to VIN...A30644

Part no. 277613

XK8 4.2 Coupe except ,R' performance options (Brembo brakes) from VIN...A30645 to A48684

Part no. 422295

XK8 4.2 Convertible except ,R' performance options (Brembo brakes) from VIN...A30645 to A48684

Part no. 277613

XK8 4.2 with ,R' performance options (Brembo brakes) from VIN...A30645 to A48684

Part no. 422912



1. SHOCK ABSORBER, WISHBONES AND COIL SPRINGS - TO 2005 MY

XK8 4.0 AND 4.2 TO VIN...A48684

10. SPRING AND DAMPER MOUNTING

XK8 4.0 to VIN...018107

Qty. required: 2 Part no. 284353

XK8 4.0 and 4.2 from VIN...018108 to A48684

Qty. required: 2 Part no. 434258



10.



11.

11. ISOLATOR BUFFER

coil spring, upper

XK8 4.0 and 4.2 to VIN...A48684

Qty. required: 2 Part no. 284356

12. SPRING COLLAR

coil spring

XK8 4.0 and 4.2 to VIN...A48684

Qty. required: 2 Part no. 284355



12.



13.

13. SPACING WASHER

coil spring

XK8 4.0 and 4.2 to VIN...A48684

height: 2.9 - 3.4 mm

Qty. required: 2 Part no. 247470

height: 6.05 - 6.55 mm

Qty. required: 2 Part no. 247471



14.

14. PACKING

coil spring, lower

XK8 4.0 and 4.2 to VIN...A48684

Qty. required: 2 Part no. 250429

18. BUSH

pendulum bottom mounting

XK8 4.0 and 4.2 to VIN...A48684

Qty. required: 4 Part no. 246809

15. BUMP STOP RUBBER

XK8 4.0 and 4.2 to VIN...A48684

Qty. required: 2 Part no. 284032



15.

19. BUSH

pendulum top mounting

XK8 4.0 and 4.2 to VIN...A48684

Qty. required: 2 Part no. 247209



18.



19.

20. STRUT

pendulum to differential, including mounting bushes

XK8 4.0 and 4.2 to VIN...A48684

Part no. 433365



20.

21. BUSH

pendulum strut - separately

XK8 4.0 and 4.2 to VIN...A48684

Qty. required: 4 Part no. 433367



21.

16. FULCRUM PIN

trailing arm to pendulum

XK8 4.0 and 4.2 to VIN...A48684

Qty. required: 2 Part no. 284195

17. NUT

trailing arm bolt

XK8 4.0 and 4.2 to VIN...A48684

Qty. required: 2 Part no. 273344



16.



17.

1. SHOCK ABSORBER, WISHBONES AND COIL SPRINGS - TO 2005 MY

XK8 4.0 AND 4.2 TO VIN...A48684

22. BUSH
subframe

XK8 4.0 and 4.2 to VIN...A48684
Qty. required: 2
Part no. 433350



23. WHEEL BEARING KIT

XK8 4.0 and 4.2 to VIN...A48684
Qty. required: 2 Part no. 17382



24. TIMING ROTOR
ABS sensor

XK8 4.0 and 4.2 to VIN...A48684
Qty. required: 2 Part no. 248435

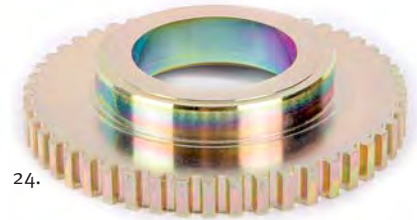

25. TUBE COLLAR
drive shaft into hub

XK8 4.0 and 4.2 to VIN...A48684
Qty. required: 2 Part no. 248841



26. LOCKING NUT
drive shaft to hub

XK8 4.0 and 4.2 to VIN...A48684
Qty. required: 2 Part no. 248939



27. WHEEL STUD

XK8 4.0 to VIN...042775
Qty. required: 10 Part no. 246661

XK8 4.0 and 4.2 from VIN...A00083 to A48684
Qty. required: 10 Part no. 281257



28. TAPERED ROLLER BEARING
hub carrier

XK8 4.0 and 4.2 to VIN...A48684
Qty. required: 4 Part no. 246800



29. SHIM

tapered roller bearing

XK8 4.0 and 4.2 to VIN...A48684
3.905 mm Part no. 283769
3.955 mm Part no. 283774
4.005 mm Part no. 283775
4.055 mm Part no. 283776
4.105 mm Part no. 283777
4.155 mm Part no. 283778
4.205 mm Part no. 283779
4.255 mm Part no. 283780
4.305 mm Part no. 283781
4.355 mm Part no. 283770
4.405 mm Part no. 283771
4.455 mm Part no. 283772
5.505 mm Part no. 283773



30. FULCRUM PIN

hub carrier to trailing arm

XK8 4.0 and 4.2 to VIN...A48684
Qty. required: 2 Part no. 281250



31. LOCATION TUBE

hub carrier fulcrum pin

XK8 4.0 and 4.2 to VIN...A48684
Qty. required: 2 Part no. 247020



32. NUT

hub carrier fulcrum pin

XK8 4.0 and 4.2 to VIN...A48684
Qty. required: 2 Part no. 280811



1. SHOCK ABSORBER, WISHBONES AND COIL SPRINGS - TO 2005 MY

XK8 4.0 AND 4.2 TO VIN...A48684

33. RUBBER BUSH

anti roll bar

XK8 4.0 and 4.2 except ,R' performance options (Brembo brakes) to VIN...A48684

Qty. required: 2 Part no. 284022

XK8 4.0 and 4.2 with ,R' performance options (Brembo brakes) to VIN...A48684

Qty. required: 2 Part no. 248491



34.

34. ANTI ROLL BAR LINK

XK8 4.0 and 4.2 to VIN...A48684

Qty. required: 2 Part no. 433968

35. RUBBER BUSH

anti roll bar link

XK8 4.0 and 4.2 to VIN...A48684

Qty. required: 4 Part no. 284444

35.

36. SPECIAL GREASE

for bushes

5 gram. Part no. 312158

36.



2. SHOCK ABSORBER AND WISHBONES - FROM 2006 MY

XK8 3.5 AND 4.2 FROM VIN...B00379, XK8 5.0 FROM VIN...B32753

1. SHOCK ABSORBER

XK8 3.5 and 4.2 except Supercharged and models with adaptive control damping (C.A.T.S) from VIN...B00379 to B32752
Qty. required: 2 Part no. 495126

XK8 3.5 and 4.2 with adaptive control damping (C.A.T.S) except Supercharged from VIN...B00379 to B32752
Qty. required: 2 Part no. 495124

XK8 4.2 Supercharged except XKR-S models from VIN...B00379 to B32752
Qty. required: 2 Part no. 495125

XK8 4.2 XKR-S models from VIN...B00379 to B32752
Qty. required: 2 Part no. 490000

XK8 5.0 from VIN...B32753 to B38853
identify by purple marking
Qty. required: 2 Part no. 495128

XK8 5.0 from VIN...B38854 to B44298
identify by green marking
Qty. required: 2 Part no. 495129

XK8 5.0 from VIN...B44299 to B44939
Qty. required: 2 Part no. 495130

XK8 5.0 from VIN...B44940
Qty. required: 2 Part no. 495131



1.

2. BUSH

shock absorber, lower mounting

XK8 3.5 and 4.2 from VIN...B00379 to B32752, XK8 5.0 from VIN...B32753
Qty. required: 2 Part no. 493019



2.

3. BOLT

shock absorber, lower mounting

XK8 3.5 and 4.2 from VIN...B00379 to B32752, XK8 5.0 from VIN...B32753
Qty. required: 2 Part no. 440616



3.

4. DUST SEAL

shock absorber

XK8 3.5 and 4.2 from VIN...B00379 to B32752, XK8 5.0 from VIN...B32753
Qty. required: 2 Part no. 496114



4.

5. PACKING PIECE

below coil spring

XK8 3.5 and 4.2 from VIN...B00379 to B32752, XK8 5.0 from VIN...B32753
Qty. required: 2 Part no. 433322



5.

6. INSULATOR

coil spring

XK8 3.5 and 4.2 from VIN...B00379 to B32752, XK8 5.0 from VIN...B32753
Qty. required: 2 Part no. 496115



6.

2. SHOCK ABSORBER AND WISHBONES - FROM 2006 MY

XK8 3.5 AND 4.2 FROM VIN...B00379, XK8 5.0 FROM VIN...B32753

7. WISHBONE

including bushes

XK8 3.5 and 4.2 except XKR-S from VIN...B00379 to B32752, XK8 5.0 except XKR-S from VIN...B32753

LH lower Part no. 495136
RH lower Part no. 495138

XK8 4.2 XKR-S from VIN...B00379 to B32752, XK8 5.0 XKR-S from VIN...B32753

LH lower Part no. 495140
RH lower Part no. 495139

8. WISHBONE

including ball joint and bushes

XK8 3.5 and 4.2 from VIN...B00379 to B32752

LH upper Part no. 490792
RH upper Part no. 389575

XK8 5.0 from VIN...B32753

LH upper Part no. 495141
RH upper Part no. 495142



9. HUB

complete with wheel bearing

XK8 3.5 and 4.2 from VIN...B00379 to B32752

Qty. required: 2 Part no. 495050

10. WHEEL STUD

XK8 3.5 and 4.2 from VIN...B00379 to B32752

Qty. required: 10 Part no. 496896

11. LOCKING NUT

hub

XK8 3.5 and 4.2 from VIN...B00379 to B32752

Qty. required: 2 Part no. 495052



12. HUB

without wheel bearing

XK8 5.0 from VIN...B32753

Qty. required: 2 Part no. 495051

13. WHEEL BEARING

XK8 5.0 from VIN...B32753

Qty. required: 2 Part no. 495048

14. CIRCLIP

wheel bearing

XK8 5.0 from VIN...B32753

Qty. required: 2 Part no. 495053

15. LOCKING NUT

hub

XK8 5.0 from VIN...B32753

Qty. required: 2 Part no. 495052



2. SHOCK ABSORBER AND WISHBONES - FROM 2006 MY

XK8 3.5 AND 4.2 FROM VIN...B00379, XK8 5.0 FROM VIN...B32753

16. RUBBER BUSH

anti roll bar

XK8 3.5 and 4.2 except XKR-S from VIN...B00379 to B32752
Qty. required: 2 Part no. 495492

XK8 4.2 XKR-S models from VIN...B00379 to VIN...B32752
Qty. required: 2 Part no. 438790

XK8 5.0 from VIN...B32753
Qty. required: 2 Part no. 495493



17. ANTI ROLL BAR LINK

XK8 3.5 and 4.2 from VIN...B00379 to B32752, XK8 5.0 from VIN...B32753
LH. Part no. 440377
RH. Part no. 440374

18. SPECIAL GREASE

for bushes

5 gram. Part no. 312158



19. STEERING ROD

rear suspension

XK8 3.5 and 4.2 from VIN...B00379 to B32752, XK8 5.0 except Supercharged from VIN...B32753 to B32963, XK8 5.0 Supercharged from VIN...B32753
Qty. required: 2 Part no. 495170

XK8 5.0 except Supercharged from VIN...B32964
Qty. required: 2 Part no. 495171



20. CASTROL GEAR OIL SAE 75W/140

XK8 3.5 and 4.2 from VIN...B00379 to B32752, XK8 5.0 except Supercharged from VIN...B32753
1 litre bottle Part no. 472147

Castrol Syntrox Limited Slip 75W/140 (Formerly SAF-XJ 75W/140) is a fully synthetic SAE 75W/140 hypoid gear oil formulated for use in both conventional and limited slip differentials. Whilst being suitable for all applications where a lubricant of this quality is specified it is specially formulated for use in limited slip differentials fitted to Japanese vehicles requiring an SAE 75W/140 Extreme Pressure Gear Oil. Castrol Syntrox Limited Slip 75W/140 has additionally demonstrated outstanding performance in competition vehicles employing limited slip differentials. Castrol Syntrox Limited Slip 75W/140 is also specifically designed for BMW differentials including the Z3 limited slip differential.

Benefits of Castrol Syntrox Limited Slip 75W/140:

- Excellent shear stability
- Exceptional resistance to oxidation
- Particularly effective resistance to very strong loads
- Very good low temperature fluidity properties
- Affords increased drain intervals
- Helps prevent vibrations / noise occurring in the transmission

Specifications and Manufacturer Approvals:

- API GL-5, ZF TE-ML- 05D, 12D, 16G, US claims - MIL-L-2105D, BMW Approved (for limited slip)



3. DIFFERENTIAL - TO MY 2005

XK8 4.0 AND 4.2 TO VIN...A48684

1. FLANGE

differential pinion, including oil seal

XK8 4.0 and 4.2 to VIN...A48684

Part no. 485480



2. OIL SEAL

differential pinion - separately

XK8 4.0 and 4.2 to VIN...A48684

Part no. 329091



3. BALL BEARING

differential pinion

XK8 4.0 and 4.2 to VIN...A48684

Part no. 421970



4. TAPERED ROLLER BEARING

differential carrier (inner bearing)

XK8 4.0 and 4.2 to VIN...A48684

Qty. required: 2 Part no. 421972



5. BALL BEARING

differential shaft (outer bearing)

XK8 4.0 and 4.2 to VIN...A48684

Qty. required: 2 Part no. 421973

6. 'O' RING

outer differential bearing

XK8 4.0 and 4.2 to VIN...A48684

Qty. required: 2 Part no. 421963



7. CIRCLIP

outer differential bearing

XK8 4.0 and 4.2 to VIN...A48684

Qty. required: 2 Part no. 421965

8. BOLT

half shaft to differential housing

XK8 4.0 and 4.2 to VIN...A48684

Qty. required: 8 Part no. 279230



9. LOCK PLATE

half shaft

XK8 4.0 and 4.2 to VIN...A48684

Qty. required: 4 Part no. 421966



10. FLEXIBLE COUPLING

propshaft

XK8 4.0 to VIN...A30644

Qty. required: 2 Part no. 249283



11. CASTROL GEAR OIL SAE 75W/140

XK8 4.0 and 4.2 to VIN...A48684

1 litre bottle Part no. 472147

Castrol Syntrox Limited Slip 75W/140 (Formerly SAF-XJ 75W/140) is a fully synthetic SAE 75W/140 hypoid gear oil formulated for use in both conventional and limited slip differentials. Whilst being suitable for all applications where a lubricant of this quality is specified it is specially formulated for use in limited slip differentials fitted to Japanese vehicles requiring an SAE 75W/140 Extreme Pressure Gear Oil. Castrol Syntrox Limited Slip 75W/140 has additionally demonstrated outstanding performance in competition vehicles employing limited slip differentials.

Castrol Syntrox Limited Slip 75W/140 is also specifically designed for BMW differentials including the Z3 limited slip differential.

Benefits of Castrol Syntrox Limited Slip 75W/140:

- Excellent shear stability
- Exceptional resistance to oxidation
- Particularly effective resistance to very strong loads
- Very good low temperature fluidity properties
- Affords increased drain intervals
- Helps prevent vibrations / noise occurring in the transmission

Specifications and Manufacturer Approvals:

- API GL-5, ZF TE-ML- 05D, 12D, 16G, US claims - MIL-L-2105D, BMW Approved (for limited slip)



Easy shunting ? ...without starting the engine

12. DOLLY

built in hydraulic provides easy lifting

- dead easy
- accurate
- ideal in confined space
- comfortable
- no need to start the engine to move th vehicle a short distance
- no sprained back pushing heavy vehicle unaided
- maximum use of space in the garage (thick foam strips on the wall prevent paint damage)
- you can even connect two cars together
- the car can be rotated through 360° on the spot

Fast and convenient lifting and moving of your vehicle. Dimensions: 880 x 620 x 305 mm. Max. load per dolly: 680 kg. Max vehicle weight: 2720 kg. The car can be rotated 360°. Solid hard rubber wheels with ball bearings. Built in hydraulic provides easy lifting.

for wheels up to 305 mm Part no. 495672
for wheels up to 330 mm Part no. 495673

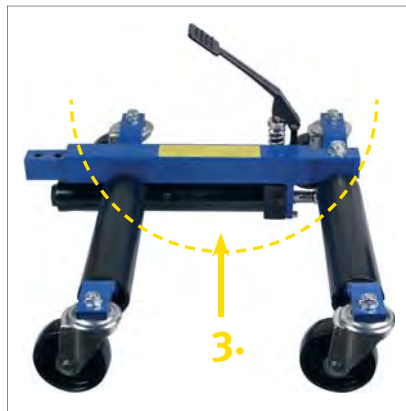
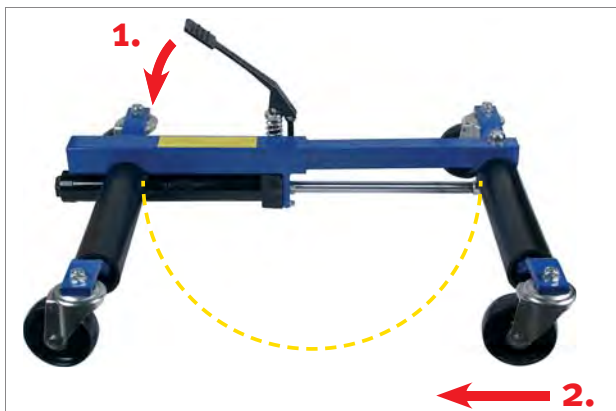

1. Simple hydraulic pump to press with your foot
2. The support rails slide together
3. The vehicle will be lifted easily

Warning: the rolles are very smooth so you should back up the whole thing with wedges. Especially if the parking area is not level.

1. FRONT BRAKES - TO 2005 MY

XK8 4.0 AND 4.2 TO VIN...A48684

1. BRAKE PADS

XK8 4.0 except ,R' performance options (Brembo brakes) to VIN...A24195

Original Jaguar Part no. 480041

XK8 4.0 and 4.2 except ,R' performance options (Brembo brakes) from VIN...A24196 to A48684

Original Jaguar Part no. 480770

XK8 4.0 and 4.2 except ,R' performance options (Brembo brakes) to VIN...A48684

Reproduction Part no. 203692



2. BRAKE PADS

XK8 4.0 and 4.2 with ,R' performance options (Brembo brakes) from VIN...A00083 to A48684

Original Jaguar Part no. 434688

Reproduction Part no. 491615



3. COPPER PASTE

Very good all round anti-seize and lubricant for high temperature applications. Avoids brake squeaking and sticking of the pads. Also protects exhaust and manifold screws and bolts against corrosion. Withstands extreme temperatures up to 1300 °C.

100 gram Part no. 329423



4. SPRING CLIP

brake pads

XK8 4.0 and 4.2 except ,R' performance options (Brembo brakes) to VIN...A48684

Qty. required: 2 Part no. 278819



5. FITTING KIT

brake pads

XK8 4.0 and 4.2 with ,R' performance options (Brembo brakes) from VIN...A00083 to A48684

Part no. 422961



6. BRAKE DISCS

vented with 305 mm diameter

XK8 4.0 except USA and Canada exports to VIN...031302, XK8 4.0 USA and Canada exports to VIN...037347

Original Jaguar

Supplied in pairs Part no. 492124

Reproduction

Qty. required: 2 Part no. 278605

Original



Reproduction



7. BRAKE DISCS

vented with 325 mm diameter

XK8 4.0 and 4.2 except ,R' performance options (Brembo brakes) from VIN...031303 to A48684

Original Jaguar

Supplied in pairs Part no. 355972

Reproduction

Qty. required: 2 Part no. 487030



8. BRAKE DISCS

vented with 355 mm diameter

XK8 4.0 with ,R' performance options from VIN...A00083 to A30644

Original Jaguar cross-drilled

Supplied in pairs Part no. 422913

Reproduction not cross-drilled

Qty. required: 2 Part no. 487034



9. BRAKE DISCS

vented with 355 mm diameter

XK8 4.2 Supercharged with ,R' performance options (Brembo brakes) from VIN...A30645 to A48684

Original Jaguar cross-drilled

Supplied in pairs Part no. 489610

Reproduction not cross-drilled

Supplied in pairs Part no. 496479



10. BRAKE DISCS

vented with 355 mm diameter

XK8 4.2 except Supercharged but with ,R' performance options (Brembo brakes) from VIN...A30645 to A48684

Original Jaguar

Supplied in pairs Part no. 493331

Reproduction

Qty. required: 2 Part no. 496480

1. FRONT BRAKES - TO 2005 MY

XK8 4.0 AND 4.2 TO VIN...A48684

11. DUST COVER

brake disc

XK8 4.0 and 4.2 except ,R' performance options (Brembo brakes) to VIN...A48684

LH. Part no. 433302
RH. Part no. 433301

XK8 4.0 and 4.2 with ,R' performance options (Brembo brakes) to VIN...A48684

LH. Part no. 434695
RH. Part no. 434694



12. BRAKE CALIPER

feature: brake system with 305 mm disc

XK8 4.0 except Supercharged to VIN...031302, XK8 4.0 Supercharged to VIN...037347

original Jaguar - new item

LH. Part no. 423073
RH. Part no. 278533

exchange

LH. Part no. 356272
RH. Part no. 356271

feature: brake system with 325 mm disc

XK8 4.0 and 4.2 except ,R' performance options (Brembo brakes) from VIN...031303 to A48684

original Jaguar - new item

LH. Part no. 423074
RH. Part no. 348437

exchange

LH. Part no. 495555
RH. Part no. 495556

13. JAGUAR BRAKE CALIPER

feature: brake system with 355 mm disc

XK8 4.0 with ,R' performance options (Brembo brakes) except Silverstone edition from VIN...A00083 to A22190

new item in grey

LH. Part no. 422957
RH. Part no. 422956

new item in silver

LH. Part no. 423105
RH. Part no. 423104

14. JAGUAR BRAKE CALIPER

feature: brake system with 355 mm disc

XK8 4.0 XKR100 edition with ,R' performance options (Brembo brakes) from VIN...A22191 to A30644

new item in silver

LH. Part no. 434687
RH. Part no. 434685

XK8 4.0 with ,R' performance options (Brembo brakes) except XKR100 edition from VIN...A22191 to A30644, XK8 4.2 with ,R' performance options (Brembo brakes) except Supercharged from VIN...A30644 to A48684

new item in grey

LH. Part no. 434686
RH. Part no. 434684

XK8 4.2 Supercharged with ,R' performance options (Brembo brakes) from VIN...A30644 to A48684

new item in grey

LH. Part no. 495537
RH. Part no. 495536

new item in red

LH. Part no. 495538
RH. Part no. 495539



12.



13.



14.

15. PISTON

brake caliper

for brake system with 305 mm disc

**XK8 4.0 except Supercharged to VIN...031302,
XK8 4.0 Supercharged to VIN...037347**

Qty. required: 2 Part no. 479994

for brake system with 325 mm disc

**XK8 4.0 and 4.2 except ,R' performance options
(Brembo brakes) from VIN...031303 to A48684**

Qty. required: 2 Part no. 495552



15.



16.

16. SEAL KIT BRAKE CALIPER

for one brake caliper

**XK8 4.0 except Supercharged to VIN...031302,
XK8 4.0 Supercharged to VIN...037347**

Qty. required: 2 Part no. 277364

**XK8 4.0 and 4.2 except ,R' performance options
(Brembo brakes) from VIN...031303 to A48684**

Qty. required: 2 Part no. 433834



17.

17. BOLT

brake caliper to hub carrier

**XK8 4.0 and 4.2 except ,R' performance options
(Brembo brakes) to VIN...A48684**

Qty. required: 4 Part no. 281239

18. BLEED SCREW

brake caliper

**XK8 4.0 and 4.2 except ,R' performance options
(Brembo brakes) to VIN...A48684**

Qty. required: 2 Part no. 433827



18.



19.

19. DUST CAP

brake caliper bleed screw

**XK8 4.0 and 4.2 except ,R' performance options
(Brembo brakes) to VIN...A48684**

Qty. required: 2 Part no. 278816



20.



21.

20. PIN

brake caliper

**XK8 4.0 and 4.2 except ,R' performance options
(Brembo brakes) to VIN...A48684**

Qty. required: 2 Part no. 278869

21. BUSH KIT

brake caliper pin

**XK8 4.0 and 4.2 except ,R' performance options
(Brembo brakes) to VIN...A48684**

Qty. required: 2 Part no. 278817

22. BOLT

brake caliper to hub carrier

**XK8 4.0 and 4.2 with ,R' performance options
(Brembo brakes) from VIN...A22191 to A48684**

Qty. required: 4 Part no. 416292



22.

23. BLEED SCREW

brake caliper

**XK8 4.0 and 4.2 with ,R' performance options
(Brembo brakes) from VIN...A22191 to A48684**

Qty. required: 2 Part no. 422960



23.

24. DUST CAP

brake caliper bleed screw

**XK8 4.0 and 4.2 with ,R' performance options
(Brembo brakes) from VIN...A22191 to A48684**

Qty. required: 2 Part no. 278816



24.

1. FRONT BRAKES - TO 2005 MY

XK8 4.0 AND 4.2 TO VIN...A48684

25. BRAKE HOSE

RH and LH

XK8 4.0 except Supercharged to VIN...024686

Qty. required: 2 Part no. 433496

XK8 4.0 and 4.2 except ,R' performance options (Brembo brakes) from VIN...024687 to A48684

Qty. required: 2 Part no. 433710

XK8 4.0 and 4.2 with ,R' performance options (Brembo brakes) from VIN...A00083 to A48684

Qty. required: 2 Part no. 434721

26. BRAKE HOSE

traction control

XK8 4.0 and 4.2 to VIN...A48684

Part no. 433531



27. BRAKE HOSES

stainless steel braided, set with 4 lines

XK8 4.0 and 4.2 except ,R' performance options (Brembo brakes) from VIN...024687 to A48684

Part no. 491717

XK8 4.0 and 4.2 with ,R' performance options (Brembo brakes) from VIN...A00083 to A48684

Part no. 372913

Goodridge have developed and manufactured hoses for the following high profile applications Formula 1, Thrust 2 (world land speed record holder), Nascar, every major Rally team. Because of their expertise in the hydraulics field they have been able to apply this knowledge to the automotive industry to give replacement brake hoses and fittings that outperform even the original equipment products. Goodridge kits feature the finest quality stainless steel braided hose, which improves braking performance, eliminates the spongy feel of rubber hoses and provides superior resistance to corrosion. Hose end fittings are zinc plated steel as standard or stainless steel as an option. Goodridge manufacture hose for all the major manufacturers.



2. FRONT BRAKES - FROM 2006 MY

XK8 3.5 AND 4.2 FROM VIN...B00379, XK8 5.0 FROM VIN...B32753

1. BRAKE PADS

feature: brake system with 326 mm disc

XK8 3.5 and 4.2 except Supercharged and models with Alcon brakes from VIN...B00379 to B32752

Original Jaguar Part no. 495811
 Reproduction Part no. 495812

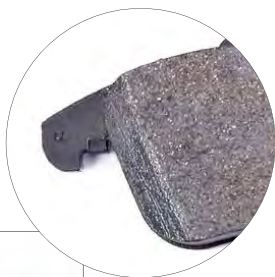

1.

2. BRAKE PADS

feature: brake system with 355 mm disc

XK8 4.2 Supercharged except models with Alcon brakes from VIN...B00379 to B32752, XK8 5.0 except Supercharged and models with Alcon brakes from VIN...B32753

Original Jaguar Part no. 492464
 Reproduction Part no. 495817



2.

3. BRAKE PADS

feature: brake system with 380 mm disc

XK8 5.0 Supercharged except models with Alcon brakes from VIN...B32753

Original Jaguar Part no. 495814
 Reproduction Part no. 495815



3.

4. BRAKE PADS

feature: brake system with 400 mm disc

XK8 4.2 with Alcon brakes from VIN...B00379 to B32752, XK8 5.0 with Alcon brakes from VIN...B32753

Original Jaguar Part no. 495813
 Reproduction Part no. 495816



4.

5. BRAKE DISCS

vented with 326 mm diameter. Supplied in pairs

XK8 3.5 and 4.2 except Supercharged and models with Alcon brakes from VIN...B00379 to B32752

Original Jaguar Part no. 487829
 Reproduction Part no. 496567



6. BRAKE DISCS

vented with 355 mm diameter. Supplied in pairs

XK8 4.2 Supercharged except Alcon brakes from VIN...B00379 to B32752, XK8 5.0 except Supercharged and models with Alcon brakes from VIN...B32753

Original Jaguar Part no. 487828
 Reproduction Part no. 496568



2. FRONT BRAKES - FROM 2006 MY

XK8 3.5 AND 4.2 FROM VIN...B00379, XK8 5.0 FROM VIN...B32753

7. JAGUAR BRAKE DISCS

vented with 380 mm diameter. Supplied in pairs

XK8 5.0 Supercharged except models with Alcon brakes from VIN...B32753
Part no. 496304



8. JAGUAR BRAKE DISC

vented with 400 mm diameter and cross-drilled

XK8 4.2 with Alcon brakes from VIN...B00379 to B32752, XK8 5.0 with Alcon brakes from VIN...B32753

LH. Part no. 496306
RH. Part no. 496308



9. PIN

brake caliper

XK8 3.5 and 4.2 except Supercharged and models with Alcon brakes from VIN...B00379 to B32752

Qty. required: 2 Part no. 278869



9.

10. BUSH KIT

brake caliper

XK8 3.5 and 4.2 except Supercharged and models with Alcon brakes from VIN...B00379 to B32752

Qty. required: 2 Part no. 495540



10.

11. COPPER PASTE

Very good all round anti-seize and lubricant for high temperature applications. Avoids brake squeaking and sticking of the pads. Also protects exhaust and manifold screws and bolts against corrosion. Withstands extreme temperatures up to 1300 °C.

100 gram Part no. 329423



XK8 4.0 AND 4.2 TO VIN...A48684

1. BRAKE PADS

XK8 4.0 and 4.2 except ,R' performance options (Brembo brakes) to VIN...A48684

Original Jaguar Part no. 329166
 Reproduction Part no. 491813



4. SPRING CLIP

brake pads

XK8 4.0 and 4.2 except ,R' performance options (Brembo brakes) to VIN...A48684

Qty. required: 2 Part no. 277363



5. FITTING KIT

brake pads

X308 (XJ8) with ,R' performance options (Brembo brakes) from VIN...812317 to F59525, XK8 4.0 and 4.2 with ,R' performance options (Brembo brakes) from VIN...A00083 to A48684

Qty. required: 2 Part no. 422962



2. BRAKE PADS

XK8 4.0 and 4.2 with ,R' performance options (Brembo brakes) from VIN...A00083 to A48684

Original Jaguar Part no. 434707
 Reproduction Part no. 349034



6. BRAKE DISCS

vented with 305 mm diameter

XK8 4.0 and 4.2 except ,R' performance options (Brembo brakes) to VIN...A48684

Original Jaguar
 Supplied in pairs Part no. 491651
 Reproduction
 Qty. required: 2 Part no. 276920



3. COPPER PASTE

Very good all round anti-seize and lubricant for high temperature applications. Avoids brake squeaking and sticking of the pads. Also protects exhaust and manifold screws and bolts against corrosion. Withstands extreme temperatures up to 1300 °C.

100 gram Part no. 329423



7. BRAKE DISCS

vented with 325 mm diameter and cross-drilled

XK8 4.0 and 4.2 ,R' performance options (Brembo brakes) from VIN...A00083 to A48684

Original Jaguar
 Supplied in pairs Part no. 422915
 Reproduction
 Supplied in pairs Part no. 491620



3. REAR BRAKES - TO 2005 MY

XK8 4.0 AND 4.2 TO VIN...A48684

8. BRAKE CALIPER

feature: brake system with 305 mm disc

Original Jaguar - new item

XK8 4.0 and 4.2 except ,R' performance options (Brembo brakes) to VIN...A48684

LH. Part no. 421897
RH. Part no. 421896

Exchange

XK8 4.0 and 4.2 except ,R' performance options (Brembo brakes) to VIN...A48684

LH. Part no. 495565
RH. Part no. 495564



8.

9. JAGUAR BRAKE CALIPER

new item. Feature: brake system with 325 mm disc

XK8 4.0 with ,R' performance options (Brembo brakes) except Silverstone edition from VIN...A00083 to A22190

in grey

LH. Part no. 422959
RH. Part no. 422958

XK8 4.0 with ,R' performance options (Brembo brakes) except Silverstone and XJR 100 edition from VIN...A22190 to A30644, XK8 4.2 with ,R' performance options (Brembo brakes) except Supercharged from VIN...A30645 to A48684

in grey

LH. Part no. 434705
RH. Part no. 434702

XK8 4.0 Silverstone edition with ,R' performance options (Brembo brakes) from VIN...A00083 to A30644

in silver

LH. Part no. 434704
RH. Part no. 434701

XK8 4.0 XJR100 edition with ,R' performance options (Brembo brakes) from VIN...A22190 to A30644

in silver

LH. Part no. 434706
RH. Part no. 434703



9.

10. JAGUAR BRAKE CALIPER

new item. Feature: brake system with 325 mm disc

XK8 4.2 Supercharged with ,R' performance options (Brembo brakes) from VIN...A30645 to A48684

in red

LH. Part no. 495577
RH. Part no. 495575

in grey

LH. Part no. 495573
RH. Part no. 495574



10.

11. DUST COVER

brake disc

XK8 4.0 except ,R' performance options (Brembo brakes) to VIN...A30644

LH. Part no. 277609
RH. Part no. 277608

XK8 4.0 with ,R' performance options (Brembo brakes) from VIN...A22190 to A30644, all XK8 4.2 from VIN...A30645 to A48684

LH. Part no. 422920
RH. Part no. 422919



12. PISTON

brake caliper. Feature: 42 mm diameter, for brake system with 305 mm disc

XK8 4.0 and 4.2 except ,R' performance options (Brembo brakes) to VIN...A48684

Qty. required: 2 Part no. 495568



12.

13. SEAL KIT BRAKE CALIPER

for one brake caliper

XK8 4.0 and 4.2 except ,R' performance options (Brembo brakes) to VIN...A48684

Qty. required: 2 Part no. 422705



13.

14. PIN

brake caliper

XK8 4.0 and 4.2 except ,R' performance options (Brembo brakes) to VIN...A48684

Qty. required: 2 Part no. 278869



14.

15. BUSH KIT

brake caliper

XK8 4.0 and 4.2 except ,R' performance options (Brembo brakes) to VIN...A48684

Qty. required: 2 Part no. 495540



15.

16. BLEED SCREW

brake caliper

XK8 4.0 and 4.2 except ,R' performance options (Brembo brakes) to VIN...A48684

Qty. required: 2 Part no. 277361



16.

17. DUST CAP

brake caliper bleed screw

XK8 4.0 and 4.2 except ,R' performance options (Brembo brakes) to VIN...A48684

Qty. required: 2 Part no. 278816



17.

18. BOLT

brake caliper to hub carrier

XK8 4.0 and 4.2 except ,R' performance options (Brembo brakes) to VIN...A48684

Qty. required: 4 Part no. 281255



18.



19.



20.



21.

19. BLEED SCREW

brake caliper

XK8 4.0 and 4.2 with ,R' performance options (Brembo brakes) from VIN...A22191 to A48684

Qty. required: 2 Part no. 422960

20. DUST CAP

brake caliper bleed screw

XK8 4.0 and 4.2 with ,R' performance options (Brembo brakes) from VIN...A22191 to A48684

Qty. required: 2 Part no. 278816

21. BOLT

brake caliper to hub carrier

XK8 4.0 with ,R' performance options (Brembo brakes) to VIN...A22190

Qty. required: 4 Part no. 281255

3. REAR BRAKES - TO 2005 MY

XK8 4.0 AND 4.2 TO VIN...A48684

22. BRAKE HOSE

XK8 4.0 and 4.2 except ,R' performance options (Brembo brakes) to VIN...A48684

Qty. required: 2 Part no. 284090

XK8 4.0 and 4.2 with ,R' performance options (Brembo brakes) from VIN...A00083 to A48684

Qty. required: 2 Part no. 434725



23. BRAKE HOSES

stainless steel braided, set with 4 lines

XK8 4.0 and 4.2 with ,R' performance options (Brembo brakes) from VIN...A00083 to A48684
Part no. 372913

XK8 4.0 and 4.2 except ,R' performance options (Brembo brakes) from VIN...024687 to A48684
Part no. 491717

Goodridge have developed and manufactured hoses for the following high profile applications Formula 1, Thrust 2 (world land speed record holder), Nascar, every major Rally team. Because of their expertise in the hydraulics field they have been able to apply this knowledge to the automotive industry to give replacement brake hoses and fittings that outperform even the original equipment products. Goodridge kits feature the finest quality stainless steel braided hose, which improves braking performance, eliminates the spongy feel of rubber hoses and provides superior resistance to corrosion. Hose end fittings are zinc plated steel as standard or stainless steel as an option. Goodridge manufacture hose for all the major manufacturers.



XK8 3.5 AND 4.2 FROM VIN...B00379, XK8 5.0 FROM VIN...B32753

1. BRAKE PADS

feature: brake system with 326 mm disc

XK8 3.5 and 4.2 except models with Alcon brakes from VIN...B00379 to B32752

Original Jaguar Part no. 494614
 Reproduction Part no. 368735



3. BRAKE PADS

feature: brake system with 380 mm disc

XK8 5.0 Supercharged except models with Alcon brakes from VIN...B32753

Original Jaguar Part no. 487830
 Reproduction Part no. 496314



2. BRAKE PADS

feature: brake system with 326 mm disc

XK8 5.0 except Supercharged and models with Alcon brakes from VIN...B32753

Original Jaguar Part no. 495821
 Reproduction Part no. 368735



4. BRAKE PADS

feature: brake system with 350 mm disc

XK8 4.2 with Alcon brakes from VIN...B00379 to B32752, XK8 5.0 with Alcon brakes from VIN...B32753

Original Jaguar Part no. 495820
 Reproduction Part no. 495822



5. BRAKE DISCS

vented with 326 mm diameter

XK8 3.5 and 4.2 except models with Alcon brakes from VIN...B00379 to B32752, XK8 5.0 except Supercharged and models with Alcon brakes from VIN...B32753

Original Jaguar
 Supplied in pairs Part no. 491520
 Reproduction
 Supplied in pairs Part no. 496565

6. JAGUAR BRAKE DISCS

vented with 380 mm diameter

XK8 5.0 Supercharged except models with Alcon brakes from VIN...B32753
 Supplied in pairs Part no. 496311



4. REAR BRAKES - FROM 2006 MY

XK8 3.5 AND 4.2 FROM VIN...B00379, XK8 5.0 FROM VIN...B32753

7. JAGUAR BRAKE DISC

vented with 350 mm diameter and cross-drilled

XK8 4.2 with Alcon brakes from VIN...B00379 to B32752, XK8 5.0 with Alcon brakes from VIN...B32753

LH. Part no. 496312

RH. Part no. 496313



11. BRAKE CLEANER

Cleans brake parts and assemblies without leaving residue. Good general purpose degreaser. Large, ergonomic actuator delivers high powered stream to remove tough deposits. Removes brake dust, solvents, greases and oils. 500 ml spray can Part no. 19339



8. PIN

brake caliper

XK8 3.5 and 4.2 except Supercharged and models with Alcon brakes from VIN...B00379 to B32752

Qty. required: 2 Part no. 278869



11.

9. BUSH KIT

brake caliper

XK8 3.5 and 4.2 except Supercharged and models with Alcon brakes from VIN...B00379 to B32752

Qty. required: 2 Part no. 495540



9.

10. COPPER PASTE

Very good all round anti-seize and lubricant for high temperature applications. Avoids brake squeaking and sticking of the pads. Also protects exhaust and manifold screws and bolts against corrosion. Withstands extreme temperatures up to 1300 °C. 100 gram Part no. 329423



XK8 4.0 AND 4.2 TO VIN...A48684

1. BRAKE SHOES

handbrake

XK8 4.0 and 4.2 to VIN...A48684

Part no. 278283



1.

2. RETURN SPRING

handbrake brake shoes, lower

XK8 4.0 and 4.2 to VIN...A48684

Qty. required: 2 Part no. 278825



2.

3. RETURN SPRING

handbrake brake shoes, upper

XK8 4.0 and 4.2 to VIN...A48684

Qty. required: 2 Part no. 278826



3.

4. REBUILT KIT

handbrake mechan. complete car set

XK8 4.0 and 4.2 to VIN...A48684

Part no. 278871



4.

5. BRAKE MASTER CYLINDER

with 3 hole fixing

XK8 4.0 without speed control to VIN...038099

Part no. 421917

with 4 hole fixing

XK8 4.0 without speed control resp. with non-adaptive speed control from VIN...038100 to A30644

Best.-Nr.422820

with 4 hole fixing

XK8 4.0 with adaptive speed control from VIN...A00083 to A30644

Part no. 422849

XK8 4.2 from VIN...30644 to A48684

Part no. 496274



5.



6.



7.

6. FILLER CAP

brake master cylinder

XK8 4.0 and 4.2 to VIN...A48684

Part no. 422858

7. PRESSURE FAILURE SWITCH

at brake master cylinder

XK8 4.0 and 4.2 from VIN...A00083 to A48684

Qty. required: 2 Best.-Nr 422850



8.

8. TRANSDUCER

dynamic stability control

XK8 4.2 from VIN...A30645 to A48684

Best.-Nr 495560

5. HAND BRAKE, BRAKE HYDRAULICS AND WHEEL SPEED SENSORS - TO 2005 MY

XK8 4.0 AND 4.2 TO VIN...A48684

9. CASTROL BRAKE FLUID

XK8 4.0 and 4.2 to VIN...A48684

React Performance DOT 4

1 litre bottle Part no. 472095

Castrol React Performance DOT 4 is a high boiling point polyglycol type brake fluid designed to provide superior braking performance in a variety of vehicles, especially those that operate at higher temperatures or under increased loads. The product has been formulated to give outstanding system protection against corrosion and high temperature vapour lock.

Castrol React Performance DOT 4 is suitable for use in all brake fluid systems in cars, motorcycles and light commercial vehicles requiring either a DOT 3, DOT 4 or Super DOT 4 product (excluding where a mineral oil based fluid is specified). Castrol React Performance DOT 4 can be used with either disc or drum brakes, including modern vehicles fitted with ABS systems. The product is also suitable for use in hydraulic clutch systems.

Product features and benefits:

1. High boiling point - exceeds US FMVSS DOT 3 and DOT 4 specification requirements, and offers a performance reserve over brake fluids with lower boiling points.
2. High vapour lock temperature - greater protection against brake fluid vaporization.
3. Corrosion protection – outstanding protection against corrosion caused by absorbed moisture, that can contribute to lower maintenance costs.
4. High temperature stability provides a greater margin for safety because product performance will not fade under higher temperatures.
5. Controlled viscosity requirements - under extremes of temperature and operating conditions, Castrol Response Super DOT 4 will maintain an optimum operating viscosity to ensure greater safety.
6. Rubber swell control - contributes to efficient operation of the braking system components.
7. Compatible with all other brake fluids that meet either DOT 3, DOT 4 or Super DOT 4 specification.



9.

10. SENSOR

wheel speed - ABS

XK8 4.0 to VIN...A30644

Qty. required: 4 Part no. 282090

XK8 4.2 from VIN...A30645 to A48684

Qty. required: 4 Part no. 495571



10.



11.

11. TIMING ROTOR

front ABS sensor

XK8 4.0 and 4.2 to VIN...A48684

Qty. required: 2 Part no. 283992



12.

12. TIMING ROTOR

rear ABS sensor

XK8 4.0 and 4.2 to VIN...A48684

Qty. required: 2 Part no. 248435

13. PULLER

ABS timing rotor

XK8 4.0 and 4.2 to VIN...A48684

Part no. 220585



13.

XK8 4.0 AND 4.2 TO VIN...A48684

14. HANDBRAKE CABLE

front

XK8 4.0 to VIN...A11210

Part no. 433709

XK8 4.0 and 4.2 from VIN...A11211 to A48684

Part no. 433779



15. HANDBRAKE CABLE

rear

XK8 4.0 and 4.2 to VIN...A48684

RH Part no. 284424

LH..... Part no. 284425

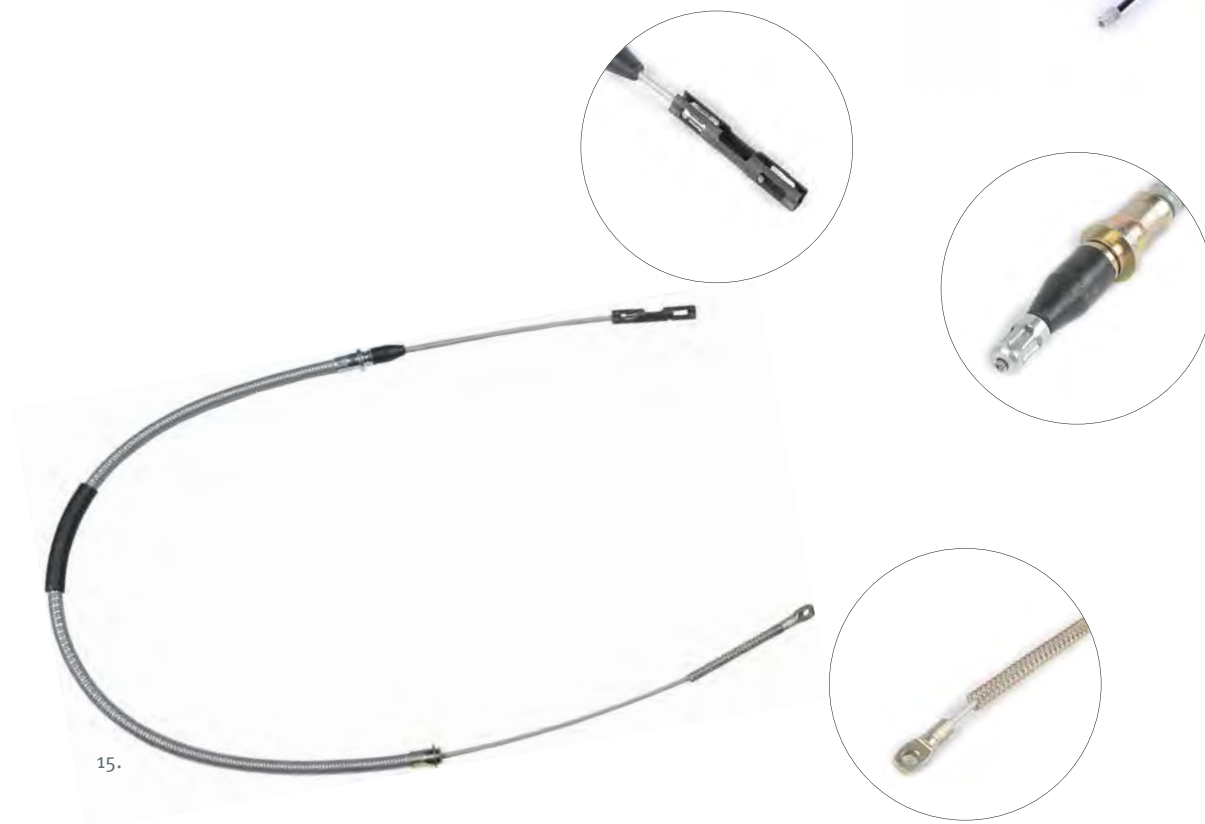

16. CONNECTOR

handbrake cable

XK8 4.0 and 4.2 to VIN...A48684

Part no. 247372



5. HAND BRAKE, BRAKE HYDRAULICS AND WHEEL SPEED SENSORS - TO 2005 MY

XK8 4.0 AND 4.2 TO VIN...A48684

17. SWITCH

handbrake warning light

XK8 4.0 to VIN...042775 (LHD models only)
Part no. 278472

18. SWITCH

handbrake warning light

XK8 4.0 to VIN...042775 (RHD models only), XK8 4.0 and 4.2 from VIN...A00083 to A48684 (LHD and RHD models)
Part no. 278471

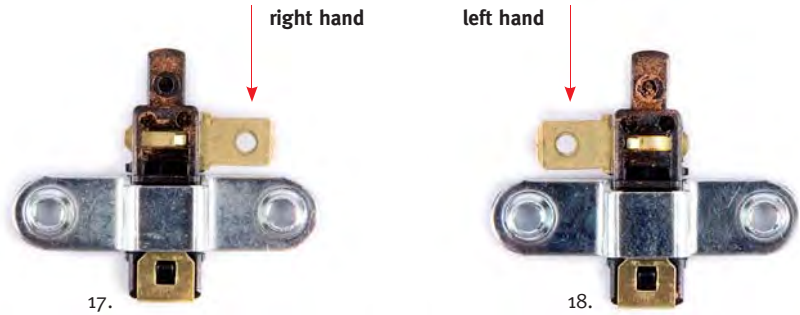

19. RETAINING CLIP

brake pipe

XK8 4.0 and 4.2 to VIN...A48684
Qty. required: 8 Part no. 281513



20. RETAINING CLIP

brake pipe

XK8 4.0 and 4.2 to VIN...A48684
Part no. 281468

21. RETAINING CLIP

brake pipe

XK8 4.0 and 4.2 to VIN...A48684
Qty. required: 2 Part no. 218856



22. RETAINING CLIP

rear brake hose

XK8 4.0 and 4.2 to VIN...A48684
Qty. required: 2 Part no. 219699

23. PEDAL RUBBER

brake pedal

XK8 4.0 and 4.2 to VIN...A48684
Part no. 434040



6. HAND BRAKE, BRAKE HYDRAULICS AND WHEEL SPEED SENSORS - FROM 2006 MY

XK8 3.5 AND 4.2 FROM VIN...B00379, XK8 5.0 FROM VIN...B32753

1. SENSOR

wheel speed front wheels - ABS

XK8 3.5 and 4.2 from VIN...B00379 to B32752
Qty. required: 2 Part no. 495572

2. SENSOR

wheel speed rear wheels - ABS

XK8 3.5 and 4.2 from VIN...B00379 to B32752
Qty. required: 2 Part no. 495571



3. HANDBRAKE CABLE

XK8 3.5 and 4.2 except Portfolio and XKR-S edition from VIN...B00379 to B32752

LH. Part no. 496321
RH. Part no. 496316

XK8 3.5 and 4.2 Portfolio and XKR-S edition from VIN...B00379 to B32752

LH. Part no. 496320
RH. Part no. 496315

XK8 5.0 except Supercharged from VIN...B32753

LH. Part no. 496322
RH. Part no. 496317

XK8 5.0 Supercharged from VIN...B32753 to B40012

LH. Part no. 496323
RH. Part no. 496318

XK8 5.0 Supercharged from VIN...B40013

LH. Part no. 496324
RH. Part no. 496319



4. PEDAL RUBBER

brake pedal

XK8 3.5 and 4.2 from VIN...B00379 to B32752, XK8 5.0 from VIN...B32753
Part no. 496330



6. HAND BRAKE, BRAKE HYDRAULICS AND WHEEL SPEED SENSORS - FROM 2006 MY

XK8 3.5 AND 4.2 FROM VIN...B00379, XK8 5.0 FROM VIN...B32753

5. EXTENSION

for accelerator and brake pedal - made from brushed aluminium, supplied in pairs

XK8 3.5 and 4.2 from VIN...B00379 to B32752
Part no. 496328

XK8 5.0 from VIN...B32753
Part no. 496684



5.

6. FILLER CAP

brake master cylinder

XK8 3.5 and 4.2 from VIN...B00379 to B32752,
XK8 5.0 from VIN...B32753
Part no. 496325



6.

7. CASTROL BRAKE FLUID

React Performance DOT 4 (may replace Response Super DOT4)

XK8 3.5 and 4.2 from VIN...B00379 to B32752,
XK8 5.0 from VIN...B32753
1 litre bottle Part no. 472095

Castrol React Performance DOT 4 is a high boiling point polyglycol type brake fluid designed to provide superior braking performance in a variety of vehicles, especially those that operate at higher temperatures or under increased loads. The product has been formulated to give outstanding system protection against corrosion and high temperature vapour lock.

Castrol React Performance DOT 4 is suitable for use in all brake fluid systems in cars, motorcycles and light commercial vehicles requiring either a DOT 3, DOT 4 or Super DOT 4 product (excluding where a mineral oil based fluid is specified). Castrol React Performance DOT 4 can be used with either disc or drum brakes, including modern vehicles fitted with ABS systems. The product is also suitable for use in hydraulic clutch systems.

Product features and benefits:

1. High boiling point - exceeds US FMVSS DOT 3 and DOT 4 specification requirements, and offers a performance reserve over brake fluids with lower boiling points.
2. High vapour lock temperature - greater protection against brake fluid vaporization.
3. Corrosion protection – outstanding protection against corrosion caused by absorbed moisture, that can contribute to lower maintenance costs.
4. High temperature stability provides a greater margin for safety because product performance will not fade under higher temperatures.
5. Controlled viscosity requirements - under extremes of temperature and operating conditions, Castrol Response Super DOT 4 will maintain an optimum operating viscosity to ensure greater safety.
6. Rubber swell control - contributes to efficient operation of the braking system components.
7. Compatible with all other brake fluids that meet either DOT 3, DOT 4 or Super DOT 4 specification.



7.

1. BADGE

for hub cap - green with silver ,Jaguar' head

XK8 4.0 except Supercharged and ,R' performance options (Brembo brakes) from VIN...A30644

Qty. required: 4 Part no. 284745



4. BADGE

for hub cap - oyster with silver ,Jaguar' head

XK8 4.0 with ,R' performance options (Brembo brakes) except Silverstone edition from VIN...A00083 to A30644

Qty. required: 4 Part no. 434787



8. BADGE

for hub cap - black with silver ,Jaguar' head

XK8 3.5, 4.2 and 5.0 except Portfolio, XKR-Special-Edition and XKR-S edition from VIN...B00379

Qty. required: 4 Part no. 490002



2. BADGE

for hub cap - red with silver ,Jaguar' head

XK8 4.0 Supercharged except ,R' performance options (Brembo brakes) from VIN...A30644

Qty. required: 4 Part no. 433726



5. BADGE

for hub cap - green with silver ,Jaguar' head

XK8 4.2 from VIN...A30645 to A48684

Qty. required: 4 Part no. 486776



9. BADGE

for hub cap - black with silver ,Jaguar' head

XK8 3.5, 4.2 and 5.0 except Portfolio, XKR-Special-Edition and XKR-S edition from VIN...B00379

Qty. required: 4 Part no. 496332



3. BADGE

for hub cap - black with silver ,Jaguar' head

XK8 4.0 Silverstone edition with ,R' performance options (Brembo brakes) from VIN...A30644

Qty. required: 4 Part no. 434788



6. BADGE

for hub cap - red with silver ,Jaguar' head

XK8 4.2 from VIN...A30645 to A48684

Qty. required: 4 Part no. 495589



10. BADGE

for hub cap - silver with black ,Jaguar' script

XK8 5.0 Portfolio edition from VIN...B32753

Qty. required: 4 Part no. 496333



7. BADGE

for hub cap - black with silver ,Jaguar' head

XK8 4.2 from VIN...A30645 to A48684

Qty. required: 4 Part no. 434788



11. BADGE

for hub cap - silver with red ,Jaguar' script

XK8 5.0 XKR-Special-Edition and XKR-S edition from VIN...B32753

Qty. required: 4 Part no. 496334



1. ROAD WHEELS AND TYRES

12. WHEEL NUT

closed end variant with 33 mm total height

XK8 4.0 and 4.2 to VIN...A48684

Qty. required: 20. Part no. 250360



12.

13. WHEEL NUT

closed end variant with 52 mm total height

XK8 4.0 and 4.2 to VIN...A48684

Qty. required: 20. Part no. 250361



14.



13.

14. WHEEL NUT

open end variant with 28 mm total height

XK8 4.0 from VIN...A00083 to A30644

Qty. required: 20. Part no. 284245

15. WHEEL NUT

closed end variant with 35 mm total height

XK8 3.5 and 4.2 from VIN...B00379 to B32752,

XK8 5.0 from VIN...B32753

Qty. required: 20. Part no. 390663



15.

Wheel lock nuts

Supplied in sets of 4. Made from steel with triple nickel plating and chrome finishing. Provides effective security for your alloy wheels, with multiple key combinations. Recognised by some insurance companies, therefore lower insurance rating may be available.

16. WHEEL LOCK NUTS

for wheel nuts with 33 mm total height

XK8 4.0 and 4.2 to VIN...A48684

Part no. 495587



16.

17. WHEEL LOCK NUTS

for wheel nuts with 52 mm total height

XK8 4.0 and 4.2 to VIN...A48684

Part no. 495588



17.

18. CAP

for wheel lock nuts

XK8 4.0 and 4.2 to VIN...A48684

Qty. required: 4 Part no. 284785



18.

19. SPECIAL SPANNER

to remove wheel lock nut caps

XK8 4.0 and 4.2 to VIN...A48684

Part no. 434084



19.

20. WHEEL STUD

front and rear

XK8 4.0 to VIN...008233 (front) and to

VIN...042775 (rear)

Qty. required: 20. Part no. 246661



20.

21. WHEEL STUD

front and rear

XK8 4.0 and 4.2 from VIN...008234 to A48684

(front) and from VIN...A00083 to A48684 (rear)

Qty. required: 20. Part no. 281257



21.

22. WIRE WHEEL

polished stainless steel, fitment: Bolt-on, rim size: 8.0j x 18", number of spokes: 70, rim inset: 6.00 mm, wheel weight: 20.50 kg, maximum wheel load: 625 kg. Including hub cap, wheel nuts and special key

XK8 4.0 and 4.2 except ,R' performance options (Brembo brakes) to VIN...A48684

Qty. required: 5 Part no. 328676



22.

23. SPOKE BRUSH

solid round brush with wooden handle, length: 380 mm

Part no. 7339



23.

24. TUGA CHEMIE WHEEL CLEANER

Aluminium Devil Special®

1000 ml pump bottle with German labeling

Part no. 492912

with English labeling

Part no. 493118

with French labeling

Part no. 493119

The new Aluminium Devil Special® is an acid-free, modern highly efficient wheel rim cleaner. This cleaner easily removes persistent and extreme pollution of the light metal and steel rims, chromed rims and hubcaps/decorative trims. The new acid-free formula is an absolute self-cleaner. When used properly, rim surfaces and wheel bolts are not pitted. In addition, Aluminium Devil Special® strongly protects all metals. Aluminium Devil Special® is recommended for regular cleaning of the above mentioned rims.



24.

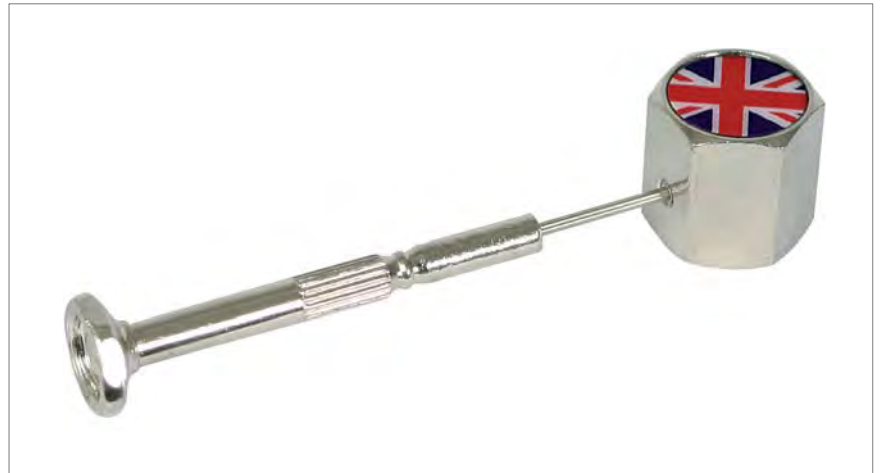

25. TYRE VALVE CAPS

chromed with golden ,Jaguar leaping cat' on green surface. Supplied in sets of 4

Part no. 251195



26. TYRE VALVE CAPS

chromed with white ,Jaguar' head on green surface. Supplied in sets of 4

Part no. 446790



27. TYRE VALVE CAPS

chromed with Union Jack logo. Supplied in sets of 4

Part no. 478517



1. STARTER MOTOR AND ALTERNATOR

1. ALTERNATOR

output: 120 ampere, pulley: S7

XK8 4.0 to VIN...A30644

new item Part no. 495590

overhauled item on

exchange basis. Part no. 429600



1.

2. ALTERNATOR

output: 140 ampere, pulley: S6

XK8 4.2 from VIN...A30645 to A48684

new item on exchange basis . . . Part no. 495591

overhauled item on

exchange basis. Part no. 496339



2.

3. ALTERNATOR

output: 140 ampere, pulley: S6

XK8 3.5 and 4.2 from VIN...B00379 to B32752

new item on exchange basis . . . Part no. 495592

overhauled item on

exchange basis. Part no. 496342



3.

4. ALTERNATOR

output: 150 ampere, pulley: S6

XK8 5.0 from VIN...B32753

new item Part no. 496335

overhauled item on

exchange basis. Part no. 496346



4.

5. DRIVE BELT

engine - multi groove type with 7 grooves

XK8 4.0 except Supercharged to VIN...042775

Part no. 285954

engine - multi groove type with 7 grooves

XK8 4.0 Supercharged to VIN...042775, all XK8 4.0 from VIN...A00083 to A30644

Part no. 434967

engine - multi groove type with 6 grooves

XK8 4.2 from VIN...A30645 to B32752, XK8 3.5 from VIN...B00379 to B32752

Part no. 480001

engine - multi groove type with 6 grooves

XK8 5.0 except Supercharged from VIN...B32753

Part no. 495242

engine - multi groove type with 6 grooves

XK8 5.0 Supercharged from VIN...B32753

Part no. 495243



5.

6. STARTER MOTOR

power output: 1.2 kW, rotation: clock wise,
voltage: 12, drive: 9 teeth

**XK8 4.0 to VIN...A30644, XK8 4.2 from VIN...
A30645 to B32752, XK8 3.5 from VIN...B00379
to B32752**

new item on exchange basis . . . Part no. 496336

overhauled item on
exchange basis. Part no. 374506



6.

7. STARTER MOTOR

power output: 1.4 kW, rotation: clock wise,
voltage: 12, drive: 9 teeth

XK8 5.0 from VIN...B32753

new item on exchange basis . . . Part no. 496337

overhauled item on
exchange basis. Part no. 496347

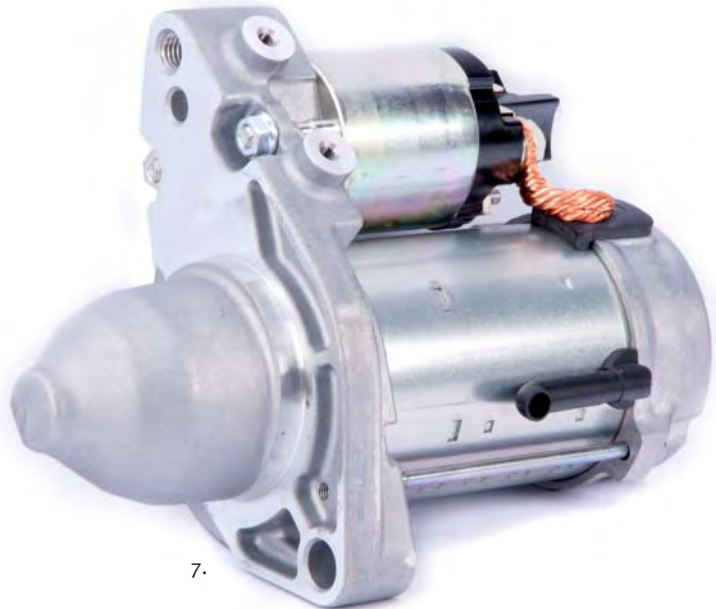

7.



2. IGNITION SYSTEM

1. NGK SPARK PLUG

XK8 4.0 except Supercharged to VIN...018107
Qty. required: 8 Part no. 494616

XK8 4.0 except Supercharged from VIN...018108 to 031302
Qty. required: 8 Part no. 435116

XK8 4.0 except Supercharged from VIN...031303 to VIN...A30644
Qty. required: 8 Part no. 356293

XK8 4.0 Supercharged to VIN...A00115
Qty. required: 8 Part no. 435120

XK8 4.0 Supercharged from VIN...A00116 to A30644, XK8 4.2 from VIN...A30645 to B32752, XK8 3.5 from VIN...B00379 to B32752
Qty. required: 8 Part no. 356293

XK8 5.0 except Supercharged from VIN...B32753
Qty. required: 8 Part no. 494659

XK8 5.0 Supercharged and XKR-S edition from VIN...B32753
Please note: this item can only be ordered with the full VIN for the vehicle
Qty. required: 8 Part no. 495213



1.

2. IGNITION MODULE

XK8 4.0 to VIN...A30644
Qty. required: 2 Part no. 282073

3. RELAY

12 volt with 40 ampere open contact - multiple function

XK8 4.0 to VIN...A30644
Qty. required: 2 Part no. 282256



2.



3.

4. IGNITION COIL

on plug type with 2 pins

XK8 4.0 to VIN...042775
Qty. required: 8
Original Part no. 281634
Reproduction Part no. 495562



4.

6. IGNITION COIL

on plug type with 4 pins

XK8 4.2 from VIN...A30645 to B32752, XK8 3.5 from VIN...B00379 to B32752
Qty. required: 8 Part no. 494619



6.

5. IGNITION COIL

on plug type with 4 pins

XK8 4.0 from VIN...042776 to A30644
Qty. required: 8 Part no. 431300



5.

7. IGNITION COIL

on plug type with 3 pins

XK8 5.0 from VIN...B32753
Qty. required: 8 Part no. 494658



7.

1. HEATER MATRIX

XK8 4.0 and 4.2 to VIN...A48684
Part no. 276960

XK8 3.5 and 4.2 from VIN...B00379 to B32752,
XK8 5.0 from VIN...B32753
Part no. 496358



1.



2.

2. HEATER HOSE

heater feed

XK8 4.0 except Supercharged to VIN...A30644
Part no. 435126

XK8 4.0 Supercharged to VIN...A30644
Part no. 435242

XK8 4.2 from VIN...A30645 to A48684
Part no. 495604



3.

3. HEATER HOSE

heater return

XK8 4.0 and 4.2 to VIN...A48684
Part no. 436399

4. HEATER HOSE

throttle body feed

XK8 4.0 from VIN...A24196 to A30644
Part no. 495850

XK8 4.2 from VIN...A30645 to A48684
Part no. 496359



4.

5. HEATER HOSE

throttle body return

XK8 4.0 to VIN...031302
Part no. 435136

XK8 4.0 from VIN...031303 to A30644
Part no. 436402

XK8 4.2 from VIN...A30645 to A48684
Part no. 495605



5.

3. HEATER UNIT AND WATER HOSES

6. HEATER HOSE

EGR valve feed

XK8 4.0 USA and Canada models to VIN...042775
Part no. 435243

XK8 4.0 Supercharged from VIN...A00083 to A30644
Part no. 436401

XK8 4.2 from VIN...A30645 to A48684
Part no. 496360



6.

7. HEATER HOSE

EGR valve return

XK8 4.0 USA and Canada models to VIN...042775
Part no. 435129

XK8 4.0 Supercharged from VIN...A00083 to A30644
Part no. 436400



7.

8. HOSE CLIP

spring loaded type - for hoses from 23 to 27 mm diameter

XK8 4.0 and 4.2 to VIN...A48684
Qty. required: 6 Part no. 273407



8.

9. HOSE CLIP

click type - for hoses from 15 to 17 mm diameter

XK8 4.0 and 4.2 to VIN...A48684
Qty. required: 6 Part no. 417552



9.

10. HEATER PIPE

made from high quality steel

XK8 3.5 and 4.2 from VIN...B00379 to B32752
Part no. 496362

XK8 5.0 from VIN...B32753
Part no. 496363



10.

11. HEATER HOSE

heater feed

**XK8 3.5 and 4.2 from VIN...B00379 to B32752,
XK8 5.0 from VIN...B32753**
Part no. 496361



11.

12. HEATER HOSE

heater return

**XK8 3.5 and 4.2 except Supercharged from
VIN...B00379 to B32752, XK8 5.0 from
VIN...B32753**
Part no. 496365



12.

13. HEATER HOSE

**XK8 3.5 and 4.2 from VIN...B00379 to B32752,
XK8 5.0 from VIN...B32753**
Part no. 496364



13.

14. HEATER VALVE

XK8 4.0 and 4.2 to VIN...A48684
Part no. 284817



14.

3. HEATER UNIT AND WATER HOSES

15. WATER PUMP

air conditioning

XK8 4.0 and 4.2 to VIN...A48684

Part no. 284131

XK8 3.5 and 4.2 from VIN...B00379 to B32752,**XK8 5.0 from VIN...B32753**

Part no. 496366

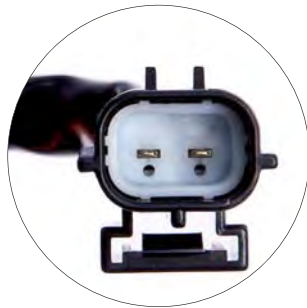

15.

16. HEATER HOSE

between engine and heater valve, including non return valve

XK8 4.0 and 4.2 to VIN...A48684

Part no. 433806

17. HEATER HOSE

between heater valve and heater matrix

XK8 4.0 and 4.2 to VIN...A48684

Part no. 284143

18. HEATER HOSE

between heater valve and air conditioning water pump

XK8 4.0 and 4.2 to VIN...A48684

Part no. 433728



16.



17.



18.

3. HEATER UNIT AND WATER HOSES

19. HEATER HOSE

between air conditioning, water pump and heater matrix

XK8 4.0 and 4.2 to VIN...A48684
Part no. 284136



19.

20. HOSE CLIP

spring loaded type - for hoses from 20 to 23 mm diameter

XK8 4.0 and 4.2 to VIN...A48684
Qty. required: 12Part no. 273411



20.



21. PLIERS

for the removal and replacement of metal or plastic spring-loaded self-tightening hose clamps

Part no. 495853



21.



Further information in Chapter 21.2

4. AIR CONDITIONING

1. EVAPORATOR

air conditioning

XK8 4.0 and 4.2 to VIN...A48684

Part no. 278620



1.

2. AIR CONDITIONING COMPRESSOR

Original Jaguar
genuine Denso 10PA17 type with 125 mm pulley
and including top cover**XK8 4.0 to VIN...019724**

Part no. 283739

Reproduction
with 135 mm pulley and less top cover**XK8 4.0 to VIN...019724**

Part no. 493955



3. 'O' RING

air conditioning compressor - small

XK8 4.0 and 4.2 to VIN...A48684

Part no. 281553



4. 'O' RING

air conditioning compressor - large

XK8 4.0 and 4.2 to VIN...A48684

Part no. 281555



5. 'O' RING

air conditioning compressor - small

XK8 3.5 and 4.2 from VIN...B00379 to B32752,**XK8 5.0 from VIN...B32753**

Part no. 496380



6. 'O' RING

air conditioning compressor - large

XK8 3.5 and 4.2 from VIN...B00379 to B32752,**XK8 5.0 from VIN...B32753**

Part no. 496381

ORIGINAL JAGUAR AIR CONDITIONING
COMPRESSOR**XK8 4.0 from VIN ...019725 to A30644, XK8 4.2
from VIN...A30645 to A48684
Best.-Nr.433210****XK8 4.2 from VIN...A30645 to A48684**

Part no. 495603

XK8 3.5 and 4.2 from VIN...B00379 to B32752

Best.-Nr.496378

XK8 5.0 from VIN...B32753

Part no. 496379



Original

2.



Reproduction

2.



7.

7. HYDRAULIC OIL

Denso ND8 - for air conditioning compressor

XK8 4.0 from VIN...A30644, **XK8 4.2** from VIN...A30645 to B32752, **XK8 3.5** from VIN...B00379 to B32752, **XK8 5.0** from VIN...B32753
250 ml tin Part no. 277493

8. CONDENSER

air conditioning

XK8 4.0 except Supercharged to VIN...042775
complete kit including 3 pipes
Part no. 284156

XK8 4.0 Supercharged to VIN...042775
Part no. 348125

XK8 4.0 from VIN...A00083 to A30644, **XK8 4.2**
from VIN...A30645 to A48684
Part no. 356164

XK8 3.5 and **4.2** from VIN...B00379 to B32752,
XK8 5.0 from VIN...B32753
Part no. 495864



8.

9. 'O' RING

air conditioning pipe - size: 18 x 2 mm

XK8 4.0 and **4.2** to VIN...A48684
Part no. 281555



9.

10. 'O' RING

air conditioning pipe - size: 15.4 x 2 mm

XK8 4.0 and **4.2** to VIN...A48684
Qty. required: 2 Part no. 281553



10.

11. 'O' RING

air conditioning pipe - size: 10 x 1.6 mm

XK8 4.0 and **4.2** to VIN...A48684
Part no. 281568



11.

4. AIR CONDITIONING

12. RECEIVER DRIER

air condition

XK8 4.0 and 4.2 to VIN...A48684

Part no. 356163



12.

15. PASSENGER COMPARTMENT AIR FILTER

XK8 4.0 and 4.2 to VIN...A48684 - LHD models only

Part no. 433814

XK8 4.0 and 4.2 to VIN...A48684 - RHD models only

Part no. 433813

XK8 3.5 and 4.2 from VIN...B00379 to B32752, XK8 5.0 from VIN...B32753

Part no. 495177



15.

16. WATER PUMP

air conditioning

XK8 4.0 and 4.2 to VIN...A48684

Part no. 284131

XK8 3.5 and 4.2 from VIN...B00379 to B32752, XK8 5.0 from VIN...B32753

Part no. 496366

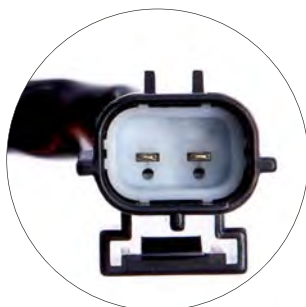

16.

13. PRESSURE SWITCH

air conditioning - identify by a rectangular compact connector with 5 pins

XK8 4.0 to VIN...A30644

Part no. 426062



13.

14. PRESSURE SWITCH

air conditioning - identify by a circular compact connector with 3 pins

XK8 4.2 from VIN...A30645 to A48684

Part no. 443609



14.

1. HEADLAMP

levelling and powerwash variant without Xenon headlight pack

XK8 4.0 and 4.2 to VIN...A48684 - LHD European models

LH. Part no. 485398
RH. Part no. 425863

levelling variant without powerwash and Xenon headlight pack

XK8 4.0 and 4.2 to VIN...A48684 - LHD European models

LH. Part no. 425855
RH. Part no. 425849

with Xenon headlight pack

XK8 4.2 from VIN...A30645 to A48684 - LHD European models

LH. Part no. 495624
RH. Part no. 495625

levelling and powerwash variant without Xenon headlight pack

XK8 4.0 and 4.2 to VIN...A48684 - RHD models except Japan

LH. Part no. 425867
RH. Part no. 425859

powerwash variant without levelling and Xenon headlight pack

XK8 4.0 and 4.2 to VIN...A48684 - RHD models except Japan

LH. Part no. 425899
RH. Part no. 425891

with Xenon headlight pack

XK8 4.2 from VIN...A30645 to A48684 - RHD models except Japan

LH. Part no. 496386
RH. Part no. 496387



5. HEADLAMPS, SIDE LAMPS AND REAR LAMPS

2. HEADLAMP LENS

for powerwash headlamp without Xenon headlight pack

XK8 4.0 and 4.2 to VIN...A48684

LH. Part no. 425903
RH. Part no. 425901

for non powerwash headlamp without Xenon headlight pack

XK8 4.0 and 4.2 to VIN...A48684

LH. Part no. 425902
RH. Part no. 425900

for headlamp with Xenon headlight pack

XK8 4.2 from VIN...A30645 to A48684

LH. Part no. 495623
RH. Part no. 495622



3. ACTUATOR

non Xenon headlamp levelling

XK8 4.0 and 4.2 to VIN...A48684

Qty. required: 2 Part no. 277357

Xenon headlamp levelling

XK8 4.2 from VIN...A30645 to A48684

Qty. required: 2 Part no. 495626

4. JET

powerwash on LH headlamp

XK8 4.0 and 4.2 to VIN...A48684

Part no. 426046

powerwash on RH headlamp

XK8 4.0 and 4.2 to VIN...A48684

Part no. 426044

5. COVER

powerwash jet on LH headlamp

XK8 4.0 and 4.2 to VIN...A48684

Part no. 426048

powerwash jet on RH headlamp

XK8 4.0 and 4.2 to VIN...A48684

Part no. 426047



6. HALOGEN BULB

dip beam - HB3 with 60 watt

XK8 4.0 and 4.2 to VIN...A48684

Qty. required: 2 Part no. 437841

7. HALOGEN BULB

main beam - H1 with 55 watt

XK8 4.0 and 4.2 without Xenon headlight pack to VIN...A48684

Qty. required: 2 Part no. 210425

8. XENON BURNER

main beam - D1S with 35 watt

XK8 4.2 with Xenon headlight pack from VIN...A30645 to A48684

Qty. required: 2 Part no. 495628

9. BULB

with clear bulb surface - side lamp

XK8 4.0 and 4.2 to VIN...A48684

Qty. required: 2 Part no. 202445

10. BULB

with amber bulb surface - front indicator

XK8 4.0 and 4.2 to VIN...A48684

Qty. required: 2 Part no. 16107

11. REFLECTOR

on front and rear bumper - identify by amber plastic lens

XK8 4.0 and 4.2 except USA, Canada and Mexico exports to VIN...A48684

Qty. required: 4 Part no. 349261

12. LAMP

repeater on front wing - identify by amber plastic lens

XK8 4.0 and 4.2 except USA, Canada and Mexico exports to VIN...A48684

Qty. required: 2 Part no. 282197

13. FOG LAMP

XK8 4.0 to VIN...A11050

LH. Part no. 282214

RH. Part no. 282213

XK8 4.0 from VIN...A11051 to A30644, XK8 4.2 from VIN...A30645 to A48684

LH. Part no. 428168

RH. Part no. 428166

Bulbs in headlamps



6.



7.



8.



9.



10.



11.



12.



13.

14. HALOGEN BULB

fog lamp - H1 with 55 watt

XK8 4.0 and 4.2 to VIN...A48684

Qty. required: 2 Part no. 210425



14.

5. HEADLAMPS, SIDE LAMPS AND REAR LAMPS

15. STONEGUARD

fog lamps - supplied as a pair of clear plastic covers

XK8 4.0 to VIN...A11050

Part no. 422415

XK8 4.0 from VIN...A11051 to A30644, XK8 4.2 from VIN...A30645 to A48684

Part no. 393285



15.

16. LAMP

lens: red and clear

XK8 4.0 to VIN...A11050

LH. Part no. 425909

RH. Part no. 425905

XK8 4.0 from VIN...A11051 to A30644, XK8 4.2 except ,R' performance options (Brembo brakes) from VIN...A30645 to A46462

LH. Part no. 428160

RH. Part no. 428158

XK8 4.2 except ,R' performance options (Brembo brakes) from VIN...A46463 to A48684, XK8 4.2 with ,R' performance options (Brembo brakes) from VIN...A30645 to A48684

LH. Part no. 495630

RH. Part no. 495629



16.

17. BULB

with clear bulb surface - stop and tail light

XK8 4.0 and 4.2 to VIN...A48684

Qty. required: 4 Part no. 7476

18. BULB

with clear bulb surface - reverse lamp and rear fog lamp

XK8 4.0 and 4.2 to VIN...A48684

Qty. required: 4 Part no. 3495

19. BULB

with amber bulb surface - rear indicator

XK8 4.0 and 4.2 to VIN...A48684

Qty. required: 2 Part no. 16107

Bulbs in tail light



17.



18.



19.



20. CHECK MODULE

for bulbs in rear lamps

XK8 4.0 to VIN...A30644
Part no. 282091



20.

21. LENS

with gasket and bulb holder
number plate lamp

XK8 4.0 to VIN...A30644
Part no. 421934



22. LENS

with gasket - LH number plate lamp

XK8 4.2 from VIN...A30645 to A46462
Part no. 428164

with gasket - RH number plate lamp

XK8 4.2 from VIN...A30645 to A46462
Part no. 428163



21.

23. BULB

with clear bulb surface - number plate lamp

XK8 4.0 and 4.2 to VIN...A48684
Qty. required: 2 Part no. 202445



22.

23.



6. WINDSCREEN WIPER AND WIPER MOTOR

1. WIPER BLADE

driver side - LHD models only

XK8 4.0 and 4.2 to VIN...A48684
Part no. 399703

driver side - RHD models only

XK8 4.0 and 4.2 to VIN...A48684
Part no. 399702

1.

2. WIPER BLADE

passenger side

XK8 4.0 and 4.2 to VIN...A48684
Part no. 399701

2.

3. RUBBER STRIP

for wiper blade

XK8 4.0 and 4.2 to VIN...A48684

Qty. required: 2 Part no. 407447



3.

4. WIPER BLADE

driver side - LHD models only

XK8 3.5 and 4.2 from VIN...B00379 to B32752,
XK8 5.0 from VIN...B32753
Part no. 495180

driver side - RHD models only

XK8 3.5 and 4.2 from VIN...B00379 to B32752,
XK8 5.0 from VIN...B32753
Part no. 495181

4.

5. WIPER BLADE

passenger side - LHD models only

XK8 3.5 and 4.2 from VIN...B00379 to B32752,
XK8 5.0 from VIN...B32753
Part no. 495182

passenger side - RHD models only

XK8 3.5 and 4.2 from VIN...B00379 to B32752,
XK8 5.0 from VIN...B32753
Part no. 495183

5.

6. WIPER MOTOR

with mechanism - LHD models only

XK8 4.0 and 4.2 to VIN...A48684
Best.-Nr.399692

with mechanism - RHD models only

XK8 4.0 and 4.2 to VIN...A48684
Part no. 399690

6.

7. WIPER MOTOR

without mechanism - LHD models only

XK8 3.5 and 4.2 from VIN...Boo379 to B32752, XK8 5.0 from VIN...B32753
Part no. 496416

without mechanism - RHD models only

XK8 3.5 and 4.2 from VIN...Boo379 to B32752, XK8 5.0 from VIN...B32753
Part no. 496417

7.

8. JET

windscreen washer - LHD models only

XK8 4.0 and 4.2 to VIN...A48684
Qty. required: 2 Part no. 399699

windscreen washer - RHD models only

XK8 4.0 and 4.2 to VIN...A48684
Qty. required: 2 Part no. 399698

8.

9. WASHER PUMP

windscreen

XK8 4.0 and 4.2 to VIN...A48684
Part no. 426041**XK8 3.5 and 4.2 from VIN...Boo379 to B32752,**
XK8 5.0 from VIN...B32753
Part no. 393207

10. SEALING RUBBER

screenwash pump

XK8 4.0 and 4.2 to VIN...A48684
Part no. 426042**XK8 3.5 and 4.2 from VIN...Boo379 to B32752,**
XK8 5.0 from VIN...B32753
Part no. 393312

11. WASHER PUMP

headlamp powerwash

XK8 4.0 to VIN...A30644
Part no. 283488**XK8 4.2 from VIN...A30645 to A48684**
Part no. 430424**XK8 3.5 and 4.2 from VIN...Boo379 to B32752,**
XK8 5.0 from VIN...B32753
Part no. 393214

11.

12. SEALING RUBBER

headlamp powerwash pump

XK8 4.0 to VIN...A30644
Part no. 283494**XK8 4.2 from VIN...A30645 to A48684**
Part no. 430427**XK8 3.5 and 4.2 from VIN...Boo379 to B32752,**
XK8 5.0 from VIN...B32753
Part no. 393976

9.



12.

6. WINDSCREEN WIPER AND WIPER MOTOR

13. WASHER BOTTLE

windscreen wiper and headlamp powerwash

XK8 4.0 and 4.2 to VIN...A48684

Part no. 422372

windscreen wiper

XK8 4.0 and 4.2 to VIN...A48684

Part no. 422371

14. FILLER NECK

with cap - washer bottle

XK8 4.0 and 4.2 to VIN...A48684

Part no. 282260

15. FILLER CAP

windscreen washer bottle - separately

XK8 4.0 and 4.2 to VIN...A48684

Part no. 430426



13.



14.



15.

16. GROMMET

screenwash hose - lower

XK8 4.0 and 4.2 to VIN...A48684

Part no. 22735



16.



17.

17. GROMMET

screenwash hose - upper

XK8 4.0 and 4.2 to VIN...A48684

Part no. 423203



1. RELAY

with 20 ampere - multiple function

XK8 4.0 and 4.2 to VIN...A48684

Part no. 429020



2. RELAY

with 40 ampere changeover - multiple function

**XK8 4.0 to VIN...A30644,
XK8 4.2 from VIN...A30645 to B32752,
XK8 3.5 from VIN...B00379 to B32752,
XK8 5.0 from VIN...B32753**

Part no. 282257



1.



2.



3. RELAY

with 40 ampere open contact - multiple function

**XK8 4.0 to VIN...A30644, XK8 3.5 and 4.2 from
VIN...B00379 to B32752, XK8 5.0 from
VIN...B32753**

Part no. 282256



3.



4. SWITCH

boot release, with connecting harness assembly

**XK8 4.0 from VIN...A11051 to A30644, 4.2 from
VIN...A30645 to A48684**

Part no. 487152

**XK8 3.5 and 4.2 from VIN...B00379 to B32752,
XK8 5.0 from VIN...B32753 to B44939**

Part no. 496450



4.

5. ELEMENT

cigar lighter

XK8 4.0 to VIN...042775

Part no. 253251

**XK8 4.0 from VIN...A00083, XK8 4.2 to
VIN...A48684**

Part no. 426590

**XK8 3.5 and 4.2 from VIN...B00379 to B32752,
XK8 5.0 from VIN...B32753**

Part no. 496451



5.

6. MAGAZINE

for original Jaguar CD autocharger

XK8 4.0 and 4.2 to VIN...A48684

Part no. 390815



6.

7. FUSES, RELAYS AND SWITCHES

7. BULB

with clear bulb surface - used on console switch module

XK8 4.0 and 4.2 to VIN...A48684
Part no. 283265



8. BULB

with blue bulb surface - used on console switch module

XK8 4.0 and 4.2 to VIN...A48684
Part no. 283266

9. BULB

festoon type with clear bulb surface - courtesy and interior lights

XK8 4.0 and 4.2 to VIN...A48684
Qty. required: 2 Part no. 2098



10. BULB

capless base type with clear bulb surface - interior light

XK8 4.0 and 4.2 to VIN...A48684
Qty. required: 2 Part no. 253313

11. BULB

with blue bulb surface and brown socket - used on air conditioning control panel

XK8 4.0 and 4.2 to VIN...A48684
Qty. required: 2 Part no. 276977

12. BULB

with green bulb surface with black socket - used on air conditioning control panel

XK8 4.0 and 4.2 to VIN...A48684
Qty. required: 2 Part no. 421955

13. BULB

with blue bulb surface and black socket - used on air conditioning control panel

XK8 4.0 and 4.2 to VIN...A48684
Qty. required: 7 Part no. 421954



14. FUSE

mega type

XK8 4.0 and 4.2 to VIN...A48684100 ampere - lettering: yellow
Part no. 433187125 ampere - lettering: green
Part no. 433188150 ampere - lettering: amber
Part no. 433189175 ampere - lettering: white
Part no. 433190200 ampere - lettering: blue
Part no. 433191225 ampere - lettering: tan
Part no. 433192250 ampere - lettering: pink
Part no. 433193

15. FUSE

standard blade type

XK8 4.0 and 4.2 to VIN...A486843 ampere, colour: purple
Part no. 4331775 ampere, colour: tan
Part no. 1168010 ampere, colour: red
Part no. 32261215 ampere, colour: blue
Part no. 29827520 ampere, colour: yellow
Part no. 46833725 ampere, colour: clear
Part no. 45613730 ampere, colour: green
Part no. 29649835 ampere, colour: green/blue
Part no. 43318540 ampere, colour: amber
Part no. 496456

Fuses for XK8 / XKR to 2005 MY



When they burn out they light up!

16. FUSES

packet with 42 standard blade type fuses.

These fuses stop the guesswork during fault finding!

Content: 5, 10, 15, 20, 25 and 30 ampere fuses,
7 of each size plus a fuse remover

Part no. 321281



17. FUSE

mini blade type with 5 ampere - colour: tan

XK8 3.5 and 4.2 from VIN...B00379 to B32752,

XK8 5.0 from VIN...B32753

Part no. 496457

mini blade type with 10 ampere - colour: red

XK8 3.5 and 4.2 from VIN...B00379 to B32752,

XK8 5.0 from VIN...B32753

Best.-Nr.496458

mini blade type with 15 ampere - colour: blue

XK8 3.5 and 4.2 from VIN...B00379 to B32752,

XK8 5.0 from VIN...B32753

Part no. 496459

mini blade type with 20 ampere - colour: yellow

XK8 3.5 and 4.2 from VIN...B00379 to B32752,

XK8 5.0 from VIN...B32753

Part no. 496460

mini blade type with 25 ampere - colour: clear

XK8 3.5 and 4.2 from VIN...B00379 to B32752,

XK8 5.0 from VIN...B32753

Part no. 496461

mini blade type with 30 ampere - colour: green

XK8 3.5 and 4.2 from VIN...B00379 to B32752,

XK8 5.0 from VIN...B32753

Part no. 496462

Fuses for XK8 / XKR from 2006 MY



17.



17.



17.

18. FUSE

standard blade type with 25 ampere
colour: clear

XK8 3.5 and 4.2 from VIN...B00379 to B32752,

XK8 5.0 from VIN...B32753

Part no. 456137



18.

standard blade type with 40 ampere
colour: amber

XK8 3.5 and 4.2 from VIN...B00379 to B32752,

XK8 5.0 from VIN...B32753

Part no. 496456



19. FUSE

mega type with 400 ampere - lettering: purple

XK8 3.5 and 4.2 from VIN...B00379 to B32752,

XK8 5.0 from VIN...B32753

Part no. 496454



19.

mega type with 500 ampere - lettering: white

XK8 3.5 and 4.2 from VIN...B00379 to B32752,

XK8 5.0 from VIN...B32753

Part no. 496455



19.

1. BODY SHELL

without bonnet, boot lid, doors and front wings

XK8 4.0 Convertible to VIN...A11050

Part no. 396579



2. BONNET

**XK8 4.0 and 4.2 except Supercharged to
VIN...A48684**

Part no. 396555

**XK8 4.0 and 4.2 Supercharged from
VIN...024687 to A48684**

Part no. 396556



3. WING

LH front

XK8 4.0 and 4.2 to VIN...A48684

Part no. 396389

RH front

XK8 4.0 and 4.2 to VIN...A48684

Part no. 348112



4. DOOR

LH

XK8 4.0 and 4.2 to VIN...A48684

Part no. 396634

RH

XK8 4.0 and 4.2 to VIN...A48684

Part no. 396633



1. REPAIR PANELS

5. DOOR SKIN

LH

XK8 4.0 and 4.2 to VIN...A48684

Part no. 257714

RH

XK8 4.0 and 4.2 to VIN...A48684

Part no. 257713



6. SIDE PANEL

LH rear

XK8 4.0 and 4.2 Convertible to VIN...A40264

Part no. 396410

RH rear

XK8 4.0 and 4.2 Convertible to VIN...A40264

Part no. 396407



7. SIDE PANEL

LH rear

XK8 4.0 and 4.2 Coupe to VIN...A40264

Part no. 257670

RH rear

XK8 4.0 and 4.2 Coupe to VIN...A40264

Part no. 257668



8. BOOT LID

for cars without stop light

XK8 4.0 Convertible to VIN...014329

Part no. 257707

for cars with stop light

XK8 4.0 Convertible from VIN...014330 to A11050

Part no. 257706

for cars with stop light

XK8 4.0 and 4.2 Convertible from VIN... A11051 to A48684

Part no. 396630

XK8 4.0 Coupe to VIN...A11050

Part no. 348089

XK8 4.0 and 4.2 Coupe from VIN... A11051 to A48684

Part no. 396629



9. HAMMER

for shrinking. With 310 mm long hickory handle and 225g steel head with 38 mm diameter

Part no. 216524



10. SUCTION PAD

suction cup with 118 mm diameter. Can be used for body work or for carrying glass and more

Part no. 21503



11. BODY CONTOUR GAUGE

with stainless steel pins for quick and precise gauging of profiles. Comes with integrated metric and imperial rule. Max depth: 50 mm, max length: 150 mm

Part no. 13098



12. PANEL BEATER SAND BAG

for the manual forming of sheet metal. Made of genuine heavy duty leather, diameter: 330 mm, to be filled with sand

Part no. 394574



13. ADVANCE BOARD

240 x 270 mm, 360° rotatable. Contains: supporting base and tear-off blocks with 2 x 50 working surfaces

Part no. 14926



14. SEALING COMPOUND

for auto body work. This 1- compound sealant can be painted, stays hard-elastic and can be used from -35° up to + 70° C. Very durable and very good adhesion.

310 ml. Part no. 243825



15. WING COVER

green padded and emblazoned with the leaping cat. Size: 90 x 50 cm

Made from nylon, washable. Doesn't scratch paintwork because of super-soft anti-slip surface on underside. No magnets inside.

Part no. 487962



1. BUMPERS

1. BUMPER

front - primed

XK8 4.0 to VIN...A11050

Part no. 480760

XK8 4.0 and 4.2 from VIN...A11051 to A40264

Part no. 413940

XK8 4.2 from VIN...A40265 to A48684

Part no. 495653



2. BUMPER ARMATURE

front bumper

XK8 4.0 and 4.2 except USA models to

VIN...A48684.

Early cars to VIN...A11050 may need in addition
two times bumper bracket 413941

Part no. 270140



3. BUMPER BRACKET

front bumper

XK8 4.0 except USA models to VIN...A11050

Qty. required: 2 Part no. 270143

XK8 4.0 and 4.2 except USA models from

VIN...A11051 to A48684

Qty. required: 2 Part no. 413941



4. FITTING KIT

front bumper

XK8 4.0 from VIN...018108 to 047275

Part no. 422277



5. THREADED RIVET

front bumper armature

XK8 4.0 and 4.2 to VIN...A40264

Qty. required: 8 Part no. 281536



6. TUBE NUT

plastic - front bumper armature

XK8 4.0 and 4.2 to VIN...A40264

Qty. required: 3 Part no. 373994



7. POPRIVET

plastic - front bumper

XK8 4.0 and 4.2 bis VIN...A40264

Qty. required: 4 Part no. 281538



8. RETAINING CLIP

front bumper - length: 34 mm, diameter: 11 mm

XK8 4.0 and 4.2 to VIN...A48684

Qty. required: 3 Part no. 281577



9. RETAINING CLIP

front bumper and underrider - length: 24 mm, diameter: 8 mm

XK8 4.0 and 4.2 to VIN...A48684

Qty. required: 6 Part no. 281580



10. UNDERRIDER

XK8 4.0 to VIN...A11050

LH. Part no. 270148

RH. Part no. 270147

XK8 4.0 and 4.2 except Supercharged from VIN...A11050 to A40264

LH. Part no. 413950

RH. Part no. 413946

XK8 4.0 and 4.2 Supercharged from VIN...A11050 to A40264

LH. Part no. 413952

RH. Part no. 413948

XK8 4.2 Supercharged from VIN...A40265 to A48684

LH. Part no. 496501

RH. Part no. 496499

XK8 4.2 except Supercharged from VIN...A40265 to A48684

LH. Part no. 496502

RH. Part no. 496503



11. MOULDING

on front bumper - made from chromed plastic

XK8 4.0 to VIN...A11050

Part no. 270137

XK8 4.0 and 4.2 from VIN...A11050 to A40264

Part no. 413927

XK8 4.2 from VIN...A40265 to A48684

Part no. 496504

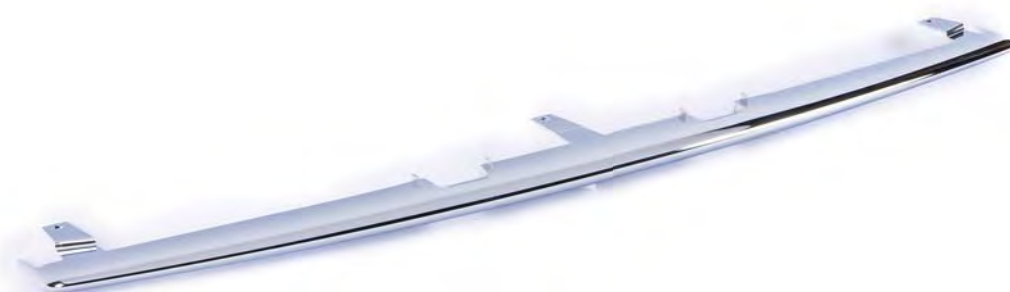

1. BUMPERS

12. BUMPER

rear - primed

XK8 4.0 to VIN...A11050

Part no. 413125

XK8 4.0 and 4.2 with rear parking aid from VIN...A11051 to A40264

Part no. 413965

XK8 4.0 and 4.2 except rear parking aid from VIN...A11051 to A40264

Part no. 413964

XK8 4.2 from VIN...A40265 to A48684

Part no. 413796



13. BUMPER ARMATURE

rear bumper

XK8 4.0 and 4.2 except USA models to VIN...A48684

Part no. 413960



14. BUMPER BRACKET

rear bumper

XK8 4.0 and 4.2 except USA models to VIN...A48684

Qty. required: 2 Part no. 270156



1. RADIATOR GRILLE PANEL

bright finish

XK8 4.0 and 4.2 Supercharged from VIN...042687 to A40264
Part no. 413799



2. RADIATOR GRILLE PANEL

bright finish

XK8 4.2 Supercharged from VIN...A40265 to A48684
Part no. 495637

black finish

XK8 4.2 Supercharged from VIN...A40265 to A48684
Part no. 495638



3. RETAINING CLIP

radiator grille panel

XK8 4.0 and 4.2 Supercharged from VIN...A00083 to A48684

Qty. required: 12 Part no. 413607



4. AIR INTAKE GRILLE

bonnet - primer painted

XK8 4.0 and 4.2 Supercharged from VIN...042687 to A48684

LH side Part no. 413603
RH side Part no. 413602



1. BADGES AND NAMEPLATES - TO 2005 MY

XK8 4.0 AND 4.2 TO VIN...A48684

1. BADGE

on bonnet - green/black with silver ,Jaguar' head

XK8 4.0 except Supercharged, Silverstone and XKR100 edition to VIN...A30644

Part no. 413925



2. BADGE

on bonnet - red/black with silver ,Jaguar' head

XK8 4.0 Supercharged except Silverstone and XKR100 edition to VIN...A30644

Part no. 413586



3. BADGE

on bonnet - black/silver with silver ,Jaguar' head

XK8 4.0 Silverstone edition from VIN...A00083 to A30644

Part no. 416286



4. BADGE

on bonnet - black/white with silver ,Jaguar' head

XK8 4.0 and 4.2 XKR100 edition from VIN...A00083 to A48684

Part no. 270130



5. BADGE

on bonnet - green/silver with silver ,Jaguar' head

XK8 4.2 Supercharged from VIN...A30645 to A48684

Part no. 496594



6. BADGE

on bonnet - green/black with silver ,Jaguar' head

XK8 4.2 except Supercharged from VIN...A30645 to A48684

Part no. 496593



7. STAR WASHER

bonnet badge

XK8 4.0 and 4.2 to VIN...A48684

Part no. 281419



8. BADGE

green with silver ,Jaguar leaping cat', self-adhesive

XK8 4.0 and 4.2 except Supercharged and Silverstone edition to VIN...A48684

LH front wing Part no. 270128

RH front wing Part no. 270129



9. BADGE

red with silver ,Jaguar leaping cat', self-adhesive

XK8 4.0 and 4.2 Supercharged except Silverstone edition to VIN...A48684

LH front wing Part no. 413795

RH front wing Part no. 413794



10. BADGE

black with silver ,Jaguar leaping cat', self-adhesive

XK8 4.0 and 4.2 Silverstone edition to VIN...A48684

LH front wing Part no. 416285

RH front wing Part no. 416284



XK8 4.0 AND 4.2 TO VIN...A48684

11. BADGE

on boot lid - green/black with silver ,Jaguar' head

XK8 4.0 except Supercharged, Silverstone and XKR100 edition from VIN...024687 to A30644
Part no. 413597



12. BADGE

on boot lid - red/black with silver ,Jaguar' head

XK8 4.0 Supercharged except Silverstone edition to VIN...A30644
Part no. 413594



13. BADGE

on boot lid - white/black with silver ,Jaguar' head and red ,Silverstone' lettering

XK8 4.0 Silverstone edition from VIN...A00083 to A30644
Part no. 416287



14. STAR WASHER

boot lid badge

XK8 4.0 and 4.2 to VIN...A48684
Part no. 281419



15. NAMEPLATE

on boot lid. Chromed ,Jaguar' lettering, self-adhesive

XK8 4.0 from VIN...024686
Part no. 270133

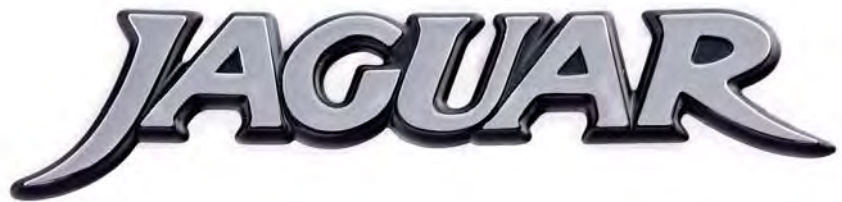

16. NAMEPLATE

on boot lid. Chromed ,Jaguar' lettering, self-adhesive

XK8 4.0 and 4.2 from VIN...024687 to A48684
Part no. 413592



17. NAMEPLATE

on boot lid. Chromed ,XK8' lettering, self-adhesive

XK8 4.0 to VIN...024686
Part no. 270132



18. NAMEPLATE

on boot lid. Chromed ,XK8' lettering, self-adhesive

XK8 4.0 except Supercharged from VIN...024687 to A30644
Part no. 413590



1. BADGES AND NAMEPLATES - TO 2005 MY

XK8 4.0 AND 4.2 TO VIN...A48684

19. NAMEPLATE

on boot lid. Chromed ,XK8' lettering, self-adhesive variant with keyhole for boot lock

XK8 4.2 except Supercharged from VIN...A30645 to A48684

Part no. 496602



20. NAMEPLATE

on boot lid. Chromed ,XK8' lettering, self-adhesive variant without keyhole for boot lock

XK8 4.2 except Supercharged from VIN...A33740 to A48684

Part no. 496603



21. NAMEPLATE

on boot lid. Chromed ,XKR' lettering, self-adhesive

XK8 4.0 Supercharged from VIN...024687 to A30644

Part no. 413588



22. NAMEPLATE

on boot lid. Chromed ,XKR' lettering, self-adhesive variant with keyhole for boot lock

XK8 4.2 Supercharged from VIN...A30645 to A48684

Part no. 496604



23. NAMEPLATE

on boot lid. Chromed ,XKR' lettering, self-adhesive variant without keyhole for boot lock

XK8 4.2 Supercharged from VIN...A30645 to A48684

Part no. 496605



24. NAMEPLATE

on boot lid. Chromed ,4.2' lettering, self-adhesive variant with keyhole for boot lock

XK8 4.2 from VIN...A33740 to A48684

Part no. 496606



25. NAMEPLATE

on boot lid. Chromed ,4.2 S' lettering, self-adhesive variant without keyhole for boot lock

XK8 4.2 from VIN...A46463 to A48684

Part no. 496607



26. LUSTER LACE POLISHING STRIPS

'narrow'. Content: 14 strips 1/2" wide

Part no. 485441

Luster Lace polish strips are designed to work on all round and tubular metal surfaces. The polish is in the cloth of the strips, no other utilities are needed to get the perfect finish. Luster Lace is fast and easy to use with 360° polishing power that can't be beat. So now you can save up to 70% of your work time. Luster Lace comes in three convenient sizes (narrow, medium, wide) for the care of parts of all sizes.



2. BADGES AND NAMEPLATES - FROM 2006 MY

XK8 3.5 AND 4.2 FROM VIN...B00379, XK8 5.0 FROM VIN...B32753

1. BADGE

on radiator grille - black with silver ,Jaguar' head

XK8 3.5 and 4.2 from VIN...B00379 to B32752
Part no. 496618



2. BADGE

on radiator grille - black/silver with silver ,Jaguar' head

XK8 5.0 from VIN...B32753 to B44939
Part no. 496619



3. BADGE

on radiator grille - silver/black with silver ,Jaguar' head

XK8 5.0 from VIN...B44940
Part no. 496620



4. NAMEPLATE

on front wing. Chromed ,Jaguar' lettering

XK8 3.5 and 4.2 except Portfolio edition from VIN...B00379 to B32752, XK8 5.0 except Portfolio edition from VIN...B32753

on LH front wing. Part no. 490436
on RH front wing Part no. 490437



5. NAMEPLATE

on boot lid. Chromed ,XK' lettering, self-adhesive

XK8 3.5 and 4.2 from VIN...B00379 to B32752, XK8 5.0 from VIN...B32753 to B44939
Part no. 496623



6. NAMEPLATE

on boot lid. Chromed ,4.2' lettering, self-adhesive

XK8 4.2 from VIN...B00379 to B32752
Part no. 496624



7. NAMEPLATE

on boot lid. Chromed ,R' lettering, self-adhesive

XK8 4.2 from VIN...B00379 to B32752, XK8 5.0 from VIN...B32753 to B44939
Part no. 496625



2. BADGES AND NAMEPLATES - FROM 2006 MY

XK8 3.5 AND 4.2 FROM VIN...B00379, XK8 5.0 FROM VIN...B32753

8. NAMEPLATE

on boot lid. Chromed ,S' lettering, self-adhesive.

Please note: this item can only be ordered with the full VIN for the vehicle

XK8 4.2 from VIN...B00379 to B32752, XK8 5.0 from VIN...B32753 to B44939

Part no. 496629



9. NAMEPLATE

on boot lid. Chromed ,XK' lettering, self-adhesive

XK8 5.0 from VIN...B44940

Part no. 496626



10. NAMEPLATE

on boot lid. Chromed ,R' lettering, self-adhesive

XK8 5.0 from VIN...B44940

Part no. 496630



11. NAMEPLATE

on boot lid. Chromed ,S' lettering, self-adhesive.

Please note: this item can only be ordered with the full VIN for the vehicle

XK8 5.0 from VIN...B44940

Part no. 496631



12. LUSTER LACE POLISHING STRIPS

'narrow'. Content: 14 strips 1/2" wide

Part no. 485441

Luster Lace polish strips are designed to work on all round and tubular metal surfaces. The polish is in the cloth of the strips, no other utilities are needed to get the perfect finish. Luster Lace is fast and easy to use with 360° polishing power that can't be beat. So now you can save up to 70% of your work time. Luster Lace comes in three convenient sizes (narrow, medium, wide) for the care of parts of all sizes.



1. GAS STRUT

bonnet

XK8 4.0 and 4.2 to VIN...A48684

Qty. required: 2 Part no. 270089



2. GAS STRUT

bonnet

XK8 4.2 from VIN...B00379 to B32752, XK8 5.0 from VIN...B32753

Qty. required: 2 Part no. 496632



3. DOOR CHECK STRAP

XK8 4.0 and 4.2 to VIN...A48684

Qty. required: 2 Part no. 348085



4. DOOR CHECK STRAP

XK8 4.2 from VIN...B00379 to B32752, XK8 5.0 from VIN...B32753

Qty. required: 2 Part no. 496634



5. THREADED RIVET

plastic - bonnet liner

XK8 4.0 and 4.2 to VIN...A48684

Qty. required: 12 Part no. 281548



6. RETAINING CLIP

for protectors in front wheel arches

XK8 4.0 and 4.2 to VIN...A48684

Qty. required: 2 Part no. 424945



7. TUBE NUT

for protectors in front and rear wheel arches

XK8 4.0 and 4.2 to VIN...A48684

Qty. required: 4 Part no. 374182



3. BODY FITTINGS

8. REMOTE KEY FOB

with 433 mhz standard sensitivity.
Please note: This article must be hard-coded by an authorised Jaguar workshop

XK8 4.0 to VIN...A11050
Qty. required: 2 Part no. 282098

with 315 mhz low sensitivity.
Please note: This article must be hard-coded by an authorised Jaguar workshop

XK8 4.0 to VIN...A11050
Qty. required: 2 Part no. 282097

with 315 mhz low sensitivity.
Please note: This article must be hard-coded by an authorised Jaguar workshop

XK8 4.0 to VIN...A11050
Qty. required: 2 Part no. 282099

with 433 mhz standard sensitivity.
Please note: This article must be hard-coded by an authorised Jaguar workshop

XK8 4.0 and 4.2 from VIN...A11051 to A48684
Qty. required: 2 Part no. 427832

with 315 mhz standard sensitivity.
Please note: This article must be hard-coded by an authorised Jaguar workshop

XK8 4.0 and 4.2 from VIN...A11051 to A48684
Qty. required: 2 Part no. 427831



9. KEY

blank with Jaguar head. Suitable for cars with key immobiliser system.
Please note: This article must be hard-coded by an authorised Jaguar workshop

XK8 4.0 from VIN...A00083 to A30644
Qty. required: 2 Part no. 495905



10. AERIAL MAST

XK8 4.0 and 4.2 to VIN...A45175
Part no. 283176



11. GAS STRUT

boot lid
XK8 4.0 and 4.2 Convertible to VIN...A48684
Qty. required: 2 Part no. 260992

XK8 4.0 and 4.2 Coupe to VIN...A48684
Qty. required: 2 Part no. 260993



12. GAS STRUT

boot lid
XK8 3.5 and 4.2 Convertible from VIN...B00379 to B32752, XK8 5.0 Convertible from VIN...B32753
Qty. required: 2 Part no. 496644

XK8 3.5 and 4.2 Coupe except XKR-S from VIN...B00379 to B32752, XK8 5.0 Coupe except XKR-S from VIN...B32753
Qty. required: 2 Part no. 496642

XK8 4.2 XKR-S Coupe from VIN...B00379 to B32752, XK8 5.0 XKR-S Coupe from VIN...B32753
Qty. required: 2 Part no. 496643



1. WINDSCREEN

with tinted glass - non heated and no rain sensor aperture

XK8 4.0 bis VIN...A24195
Part no. 261047

with tinted glass - heated but no rain sensor aperture

XK8 4.0 to VIN...A24195
Part no. 261048

with tinted glass - non heated and with circular rain sensor aperture

XK8 4.0 from VIN...A00083 to A28832
Part no. 400484

with tinted glass - heated and with circular rain sensor aperture

XK8 4.0 from VIN...A00083 to A28832
Part no. 400482

with tinted glass - non heated and with triangular rain sensor aperture

XK8 4.0 and 4.2 from VIN...A28833 to A48684
Part no. 401174

with tinted glass - heated and with triangular rain sensor aperture

XK8 4.0 and 4.2 from VIN...A28833 to A48684
Part no. 495644



2. RETAINING CLIP

windscreen - length: 35 mm

XK8 4.0 and 4.2 to VIN...A48684
Qty. required: 2 Part no. 495645

windscreen - length: 70 mm

XK8 4.0 and 4.2 to VIN...A48684
Qty. required: 12 Part no. 400278



3. RUBBER BUFFER

windscreen

XK8 4.0 and 4.2 to VIN...A48684
Qty. required: 2 Part no. 441572



4. CONNECTOR

heated windscreen

XK8 4.0 and 4.2 to VIN...A48684
Part no. 424731



1. GLASS AND GLAZING

5. WINDSCREEN

with tinted glass - non heated

XK8 3.5 and 4.2 from VIN...Boo379 to B13068
Part no. 495643

with tinted glass - non heated

XK8 3.5 and 4.2 from VIN...B13069 to B32752
Part no. 495656

with tinted glass - non heated

XK8 5.0 from VIN...B32753
Part no. 495657

with tinted glass - heated

XK8 3.5 and 4.2 from VIN...Boo379 to B13068
Part no. 495658

with tinted glass - heated

XK8 3.5 and 4.2 from VIN...B13069 to B32752
Part no. 495659

with tinted glass - heated

XK8 5.0 from VIN...B32753
Part no. 495660



6. RUBBER BUFFER

windscreen

XK8 3.5 and 4.2 from VIN...Boo379 to B32752,
XK8 5.0 from VIN...B32753
Qty. required: 6 Part no. 441572



6.

8. TOOL KIT

for the removal of bonded screens, supplied in a 7 piece kit. Contents cutting wire, 2 wire handles, bonded screen removal tool, starter tool, trim clip remover and a trim pad remover

Part no. 245566



8.

9. CW 1:100 ® SCREEN TREATMENT

removes blinding, oily films with greatest economy – 1:200 concentrate with dosage head.

250 ml bottle Part no. 492763

The economy of CW 1:100 Classic is unbeatable. One 250 ml bottle can be diluted to a ratio of 1:200, thus produces 50 litres of highly effective cleaning liquid. Removes blinding, oily films from the windscreen, and is the best product for the quality-conscious, economical driver. Special action: Increases the life of windscreen wipers. Can be mixed with any commercial antifreeze. Is also suitable for plastic headlight lenses and fan nozzles.



9.

7. GLASS BONDING ADHESIVE

contents: 300 ml adhesive cartridge and 30 ml bottle activator. Supplied with a multilingual instruction sheet

Part no. 317293



7.

1. MIRROR GLASS

for door mirror with automatic dimming function

XK8 4.0 and 4.2 to VIN...A48684

flat Part no. 270969

convex. Part no. 415975

aspheric - for door mirrors with automatic dimming function

XK8 4.0 and 4.2 to VIN...A48684

Qty. required: 2

aspheric. Part no. 422380

**Insider tip**

The convex mirror is curved. The constant radius of curvature of the lens gives a broader field of vision but the images tend to be greatly distorted. The aspheric mirror differs from the convex mirror in that 80% of the surface is convex with a large radius of curvature while the remaining 20% of the mirror, or the outside edge, is convex where the radius of the curvature decreases dramatically. The result is that the aspheric mirror produces a less distorted image while at the same time producing a field of vision up to 65% greater than that of the convex mirror.

2. COVER

primed

XK8 4.0 and 4.2 to VIN...A48684

LH door mirror Part no. 270963

RH door mirror Part no. 270962

chromed

XK8 4.0 and 4.2 to VIN...A48684

LH door mirror Part no. 271011

RH door mirror Part no. 271010

**3. RETAINING CLIP**

door mirror cover

XK8 4.0 and 4.2 to VIN...A48684

Qty. required: 6 Part no. 271007



3.



2. DOOR MIRRORS AND INTERIOR MIRROR

4. MIRROR GLASS

for door mirror without automatic dimming function

XK8 3.5 and 4.2 from B00379 to B32752

flat Part no. 490445
convex. Part no. 496659

for door mirror with automatic dimming function

XK8 3.5 and 4.2 from B00379 to B32752

flat Part no. 496665
convex. Part no. 496664

for door mirror with automatic dimming function

XK8 5.0 from VIN...B32753

convex - for LH side Part no. 496660
convex - for RH side Part no. 496662



5. COVER

door mirror, chromed

XK8 3.5 and 4.2 from B00379 to B32752

LH. Part no. 496654
RH. Part no. 496655

door mirror, primed

XK8 3.5 and 4.2 from B00379 to B32752

LH. Part no. 490444
RH. Part no. 496657

door mirror, primed

XK8 5.0 from VIN...B32753

LH. Part no. 496656
RH. Part no. 496658



6. INTERIOR MIRROR

with manual dimming function

XK8 4.0 to VIN...011698
Part no. 412957

with automatic dimming function

XK8 4.0 to VIN...011698
Part no. 270983

with automatic dimming function

XK8 4.0 from VIN...001150 to 011698
Part no. 412958

with automatic dimming function but without twilight sentinel. Fits to cars with daytime running lamps option

XK8 4.0 from VIN...011699 to 042775
Part no. 270096

with automatic dimming function and twilight sentinel. Fits to cars with auto headlamp option

XK8 4.0 from VIN...011699 to 042775
Part no. 415579

with automatic dimming function and rain sensing system. Fits to cars with auto headlamp option

XK8 4.0 from VIN...A00083 to A30644
Part no. 413782

with automatic dimming function but without rain sensing system. Fits to cars with auto headlamp option

XK8 4.0 from VIN...A00083 to A30644
Part no. 413780

with automatic dimming function

XK8 4.0 from VIN...A00083 to A30644
Part no. 412958

with automatic dimming function and rain sensing system but without compass display. Fits to cars with auto headlamp option

XK8 4.2 from VIN...A30645 to A48684
Part no. 493868

with automatic dimming function, rain sensing system and compass display. Fits to cars with auto headlamp option

XK8 4.2 from VIN...A30645 to A48684
Part no. 493867



7. INTERIOR MIRROR

with automatic dimming function, rain sensing system and compass display. Fits to cars with auto headlamp option

XK8 3.5 and 4.2 from B00379 to B32752,
XK8 5.0 from VIN...B32753
Part no. 496646



1. FOOTWELL CARPETS, GEAR KNOBS AND THRESHOLD PLATES

1. JAGUAR GEAR KNOB

for selector lever. Made from light hazelnut, without logo

XK8 4.0 to VIN...A30644,
XK8 4.2 from VIN...A30645 to B32752,
XK8 3.5 from VIN...B00379 to B32752,
XK8 5.0 from VIN...B32753
 Part no. 284587



1.

2. CONE

for selector lever 284587

XK8 4.0 to VIN...A30644,
XK8 4.2 from VIN...A30645 to B32752,
XK8 3.5 from VIN...B00379 to B32752,
XK8 5.0 from VIN...B32753
 Part no. 495910



2.

3. JAGUAR GEAR KNOB

for selector lever. Made from dark walnut, with engraved „Jaguar“ logo

XK8 4.0 to VIN...A30644,
XK8 4.2 von VIN...A30645 bis B32752,
XK8 3.5 from VIN...B00379 to B32752,
XK8 5.0 from VIN...B32753
 Part no. 495666



3.

4. GEAR KNOB

for selector lever. reproduction made from dark walnut and comes without logo

XK8 4.0 to VIN...A30644,
XK8 4.2 from VIN...A30645 to B32752,
XK8 3.5 from VIN...B00379 to B32752,
XK8 5.0 from VIN...B32753
 Part no. 349113



4.

5. GEAR KNOB

for selector lever. Reproduction made from light hazelnut and comes without logo

XK8 4.0 to VIN...A30644,
XK8 4.2 from VIN...A30645 to B32752,
XK8 3.5 from VIN...B00379 to B32752,
XK8 5.0 from VIN...B32753
 Part no. 349112



5.

6. JAGUAR GEAR KNOB

for selector lever. Made from chromed aluminium, without logo

XK8 4.0 to VIN...A30644,
XK8 4.2 from VIN...A30645 to B32752,
XK8 3.5 from VIN...B00379 to B32752,
XK8 5.0 from VIN...B32753
 Part no. 495667



6.

7. HYDRAULIC OIL

XK8 4.0 Convertible to VIN...A30644, XK8 4.2 Convertible von VIN...A30645 bis B32752, XK8 3.5 Convertible from VIN...Boo379 to B32752, XK8 5.0 Convertible from VIN...B32753
 1 litre tin Part no. 422783

For ride level control, shock absorber hydro pneumatic suspension, power steering, convertible top hydraulics. Range of operation: -40° C to +130° C.



8. HOLDER

for cup in console lid

XK8 4.0 and 4.2 to VIN...A48684
 Part no. 405577



9. MAGAZINE

for original Jaguar CD autochanger

XK8 4.0 and 4.2 to VIN...A48684
 Part no. 390815



1. FOOTWELL CARPETS, GEAR KNOBS AND THRESHOLD PLATES

10. BOOT MAT

dark grey - for cars with compact disc player

XK8 4.0 and 4.2 to VIN...A48684

Part no. 393289

dark grey - for cars without compact disc player

XK8 4.0 and 4.2 to VIN...A48684

Part no. 393290

Insider tip

This mat provides added protection of the original luggage compartment carpet to ensure your vehicle is kept in pristine condition. The mat is resistant to water, mud, grease and other materials likely to soil the original compartment carpet. The mat has a non-slip backing to keep it securely in place.



11. BOOT LINER

plastic - for cars with space saver spare wheel

XK8 4.0 and 4.2 to VIN...A48684

Part no. 393283

plastic - for cars without space saver spare wheel

XK8 4.0 and 4.2 to VIN...A48684

Part no. 422538

plastic - for cars with space saver spare wheel

XK8 3.5 and 4.2 from VIN...Boo379 to B32752,

XK8 5.0 from VIN...B32753

Part no. 496683

Insider tip

Designed to exactly match the vehicle's boot to maximise space and protection. Ideal for stowing golf and other sports equipment. This easy to clean liner assures minimal cargo movement and can be installed and removed quickly.



12. EXTENSION

for accelerator and brake pedal - made from brushed aluminium, supplied in pairs - for LHD models only

XK8 4.0 and 4.2 to VIN...A48684

Part no. 496685

for accelerator and brake pedal - made from brushed aluminium, supplied in pairs

XK8 3.5 and 4.2 from VIN...Boo379 to B32752,

XK8 5.0 from VIN...B32753

Part no. 496328

for accelerator and brake pedal - made from brushed aluminium, supplied in pairs - for RHD models only

XK8 4.0 and 4.2 to VIN...A48684

Part no. 496686

for accelerator and brake pedal - made from brushed aluminium, supplied in pairs

XK8 5.0 from VIN...B32753

Part no. 496684



12.

1. FOOTWELL CARPETS, GEAR KNOBS AND THRESHOLD PLATES

13. THRESHOLD PLATE

sill - stainless steel with ,Jaguar XK8' lettering

XK8 4.0 and 4.2 to VIN...A48684

Qty. required: 2 Part no. 413598



14. THRESHOLD PLATE

sill - stainless steel with ,Jaguar XKR' lettering

XK8 4.0 and 4.2 to VIN...A48684

Qty. required: 2 Part no. 413599



15. THRESHOLD PLATE

sill - stainless steel with ,R' lettering

XK8 4.0 and 4.2 to VIN...A48684

Qty. required: 2 Part no. 416289



16. THRESHOLD PLATE

sill - aluminium with brushed finish and ,Jaguar' lettering

XK8 3.5 and 4.2 from VIN...B00379 to B32752

Qty. required: 2 Part no. 496688



sill - stainless steel with ,Jaguar' lettering

XK8 5.0 from VIN...B32753

Qty. required: 2 Part no. 496689



1. FOOTWELL CARPETS, GEAR KNOBS AND THRESHOLD PLATES

17. RUBBER MATS

footwell, black with ‚XK8‘ script - supplied in pairs and fits to LHD models only

XK8 4.0 and 4.2 to VIN...A48684
Part no. 278551

footwell, black with ‚XK8‘ script - supplied in pairs and fits to RHD models only

XK8 4.0 and 4.2 to VIN...A48684
Part no. 278550



17.

18. CONNOLLY LEATHER CARE KIT

contents: 500 ml leather cleaner and 284 ml hide care waxy cream

Part no. 355874



18.



1. FOOTWELL CARPETS, GEAR KNOBS AND THRESHOLD PLATES

19. FOOTWELL CARPETS

flint grey - supplied in sets of 4 for LHD models

XK8 4.0 and 4.2 to VIN...A48684
Part no. 497372

flint grey - supplied in sets of 4 for RHD models

XK8 4.0 and 4.2 to VIN...A48684
Part no. 497282



20. FOOTWELL CARPETS

light grey - supplied in sets of 4 for LHD models

XK8 4.0 and 4.2 to VIN...A48684
Part no. 497373

light grey - supplied in sets of 4 for RHD models

XK8 4.0 and 4.2 to VIN...A48684
Part no. 497283



21. FOOTWELL CARPETS

black - supplied in sets of 4 for LHD models

XK8 4.0 and 4.2 to VIN...A48684
Part no. 321167

black - supplied in sets of 4 for RHD models

XK8 4.0 and 4.2 to VIN...A48684
Part no. 497407



22. FOOTWELL CARPETS

sable - supplied in sets of 4 for LHD models

XK8 4.0 and 4.2 to VIN...A48684
Part no. 497374

sable - supplied in sets of 4 for RHD models

XK8 4.0 and 4.2 to VIN...A48684
Part no. 497284



Old Love never dies

- Accessories
- Tools
- Oils and lubricants
- Internal and external fixtures
- Books and manuals
- Tuning
- Seat belts

Old love never dies

German Part no. 492147

English Part no. 15119

French Part no. 491321



Order catalogue:



Order a free copy:

www.Limora.com

1. FILTERMAG FILTERMAGNET

high performance type, for oil filters from 2.90" to 3.40" diameter, height 2.625"

XK8 4.0 to VIN...A30644,
XK8 4.2 from VIN...A30645 to B32752,
XK8 3.5 from VIN...B00379 to B32752
 Part no. 481135

FilterMAG's powerful rare-earth magnets trap and hold wear-inducing metal particles smaller than 40 microns down to 1 micron that the filter cannot stop. It extends oil life and reduces maintenance costs. Easy fitting while magnetic force „snaps“ FilterMAG to the filter canister. FilterMAG has a lifetime warranty.



May replace original filter element and has the following benefits: high air flow with excellent filtration, will lead to more horsepower and better acceleration, washable and reusable.

5. K&N AIR FILTER

element

XK8 4.0 and 4.2 to VIN...A48684
 Part no. 486030

6. K&N AIR FILTER

elements - supplied in pairs

XK8 5.0 from VIN...B32753
 Part no. 495408



6.



5.

Oils and cleaner fluids for K&N air filter in chapter 21.6

2. OIL DRAIN VALVE

steel - may replace original drain plug on engine valve thread: M 14 x 1,5 connector thread: M 22 x 1,5

XK8 4.0 and 4.2 to VIN...A48684
 Part no. 488046



3. CONNECTOR

for oil drain valve. thread: M22 x 1.5 angle 45° hose length: 25 cm

XK8 4.0 and 4.2 to VIN...A48684
 Part no. 487915



4. OIL DRAIN PAN

16 l volume, height: 14 cm, integrated funnel, large handles, acid resistant, antisplash-system, very practical for a convenient and clean oil change

Part no. 293584



1. COMPETITION PARTS

7. THERMOSTAT HOUSING

new improved alloy version

This upgrade kit replaces the original plastic thermostat housing. We have put together an aluminum thermostat housing assembly, more durable than its plastic counterpart. This kit will include the housing, cap, thermostat cover and seals. This is an exact replacement of the plastic version and will meet or exceed the factory specifications.

XK8 4.0 except Supercharged to VIN...A30644
Part no. 488148



8. POLYURETHANE BUSH KIT

front suspension

Polyurethane bushes give improved suspension support with a greater wear resistance compared to their rubber equivalents. They are naturally self-lubricating. A worthwhile addition to any car, the polyethylene bushes are supplied individually, with a steel sleeve where necessary.

XK8 4.0 and 4.2 to VIN...A48684
Part no. 493936



9. WHEEL ARCH SET

chromed stainless steel, installation either with clips or screws. Supplied in sets of four

XK8 4.0 and 4.2 to VIN...A48684
Part no. 320247



10. BRAKE HOSES

stainless steel braided, set with 4 lines

Goodridge have developed and manufactured hoses for the following high profile applications Formula 1, Thrust 2 (world land speed record holder), Nascar, every major Rally team. Because of their expertise in the hydraulics field they have been able to apply this knowledge to the automotive industry to give replacement brake hoses and fittings that outperform even the original equipment products. Goodridge kits feature the finest quality stainless steel braided hose, which improves braking performance, eliminates the spongy feel of rubber hoses and provides superior resistance to corrosion. Hose end fittings are zinc plated steel as standard or stainless steel as an option. Goodridge manufacture hose for all the major manufacturers.

XK8 4.0 and 4.2 with ,R' performance options (Brembo brakes) from VIN...A00083 to A48684
Part no. 372913

XK8 4.0 and 4.2 except ,R' performance options (Brembo brakes) from VIN...024687 to A48684
Part no. 491717



10.

11. BATTERY-BOOSTER

12 volts, 800 amp, integrated wires with claps, illumination with 2 bright LED, small dimension, only 4.6 kgs!

This battery booster is the smallest most powerful jumpstart pack in its class with a 14AH high capacity. The booster delivers instant cold crank power when you need it and has a fast rechargeable long life battery. It is easy to handle, the total weight is only 4.8 kg and it is extremely compact, making it easy to store in your car, camper van, boat or jet ski.

Part no. 492832



11.

12. C TEK BATTERY CHARGER

MXS 5.0, new Generation for 12 volt batteries up to 160 AH, charging current: 0.8/5.0 A.

This battery charger can solve a broad range of battery-related problems and is the perfect charger for those with high demands. The Ctek MXS5.0 offers features such as battery diagnosis that shows if a battery can receive and retain a charge, a special reconditioning function that restores stratified and deeply discharged batteries, unique maintenance charging, a mode for optimised charging during cold winter days and the charging of demanding AGM batteries.

With Euro plug Part no. 496284
With UK plug Part no. 496285



12.

1. COMPETITION PARTS

13. REMOTE KEY FOB

with 433 mhz standard sensitivity. Please note: This article must be hard-coded by an authorised Jaguar workshop

XK8 4.0 to VIN...A11050
Part no. 282098

with 315 mhz low sensitivity. Please note: This article must be hard-coded by an authorised Jaguar workshop

XK8 4.0 to VIN...A11050
Part no. 282097

with 315 mhz low sensitivity. Please note: This article must be hard-coded by an authorised Jaguar workshop

XK8 4.0 to VIN...A11050
Part no. 282099

with 433 mhz standard sensitivity. Please note: This article must be hard-coded by an authorised Jaguar workshop

XK8 4.0 and 4.2 from VIN...A11051 to A48684
Part no. 427832

with 315 mhz standard sensitivity. Please note: This article must be hard-coded by an authorised Jaguar workshop

XK8 4.0 and 4.2 from VIN...A11051 to A48684
Part no. 427831



14. EBC BRAKE PADS

front, Kevlar ,green stuff' specification

The material used in ,green stuff 2000 series' brake pads is Kevlar based. The brake pads give a strong progressive braking from low temperature up to 900°F, they are great for fast road, road sport and light race cars. Most „green stuff“ brake pads are type approved ,E' marked and meet the Reg.90 certification, this information will be found on bottom of each package. As an added bonus Kevlar based brake pads produce less brake dust than other materials and have fantastic wear life.

XK8 4.0 and 4.2 except ,R' performance options (Brembo brakes) to VIN...A48684

Part no. 497061

XK8 4.0 and 4.2 with ,R' performance options (Brembo brakes) from VIN...A00083 to A48684

Part no. 497063

XK8 3.5 and 4.2 except Supercharged and models with Alcon brakes from VIN...B00379 to B32752

Part no. 497065

XK8 4.2 Supercharged except models with Alcon brakes from VIN...B00379 to B32752, XK8 5.0 except Supercharged and models with Alcon brakes from VIN...B32753

Part no. 497068

XK8 5.0 Supercharged except models with Alcon brakes from VIN...B32753

Part no. 497070

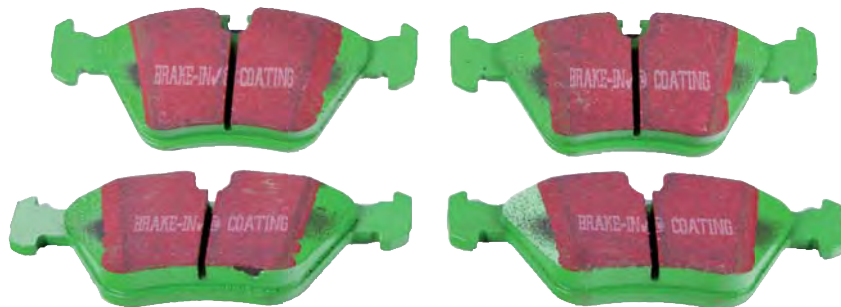

15. EBC BRAKE PADS

front, Ceramic ,red stuff' specification

This material is a Kevlar® fibre based brake compound enhanced with ceramic particles. Being a hard wearing pad, bed-in times can be as long as 1000 miles and drivers must be patient until the pad takes up the shape of their disc. This is a truly impressive fast road pad for repeated heavy braking. It emits far less dust than semi-metallic pads and has been proven to stop a passenger car 13 metres quicker than OEM pads from 100mph/160kph. Features EBC Brake-In surface coating which conditions disc surface and accelerates pad bed-in. Nominal friction coefficient 0.5 with approx. 50% dust reduction. Most EBC Red Ceramic pads are approved to ECE R90 brake safety regulation.

XK8 4.0 and 4.2 except ,R' performance options (Brembo brakes) to VIN...A48684

Part no. 485429

XK8 4.0 and 4.2 with ,R' performance options (Brembo brakes) from VIN...A00083 to A48684

Part no. 497062

XK8 3.5 and 4.2 except Supercharged and models with Alcon brakes from VIN...B00379 to B32752

Part no. 497066

XK8 4.2 Supercharged except models with Alcon brakes from VIN...B00379 to B32752, XK8 5.0 except Supercharged and models with Alcon brakes from VIN...B32753

Part no. 497069

XK8 5.0 Supercharged except models with Alcon brakes from VIN...B32753

Part no. 497072



16. EBC BRAKE PADS

rear, Kevlar ,green stuff' specification

The material used in ,green stuff 2000 series' brake pads is Kevlar based. The brake pads give a strong progressive braking from low temperature up to 900°F, they are great for fast road, road sport and light race cars. Most „green stuff“ brake pads are type approved ,E' marked and meet the Reg.90 certification, this information will be found on bottom of each package. As an added bonus Kevlar based brake pads produce less brake dust than other materials and have fantastic wear life.



XK8 4.0 and 4.2 except ,R' performance options (Brembo brakes) to VIN...A48684

Part no. 497394

XK8 4.0 and 4.2 with ,R' performance options (Brembo brakes) from VIN...A00083 to A48684

Part no. 497396

XK8 3.5 and 4.2 except models with Alcon brakes from VIN...B00379 to B32752, XK8 5.0 except Supercharged and models with Alcon brakes from VIN...B32753

Part no. 497398



17. EBC BRAKE PADS

rear, Kevlar ,red stuff' specification

This material is a Kevlar® fibre based brake compound enhanced with ceramic particles. Being a hard wearing pad, bed-in times can be as long as 1000 miles and drivers must be patient until the pad takes up the shape of their disc. This is a truly impressive fast road pad for repeated heavy braking. It emits far less dust than semi-metallic pads and has been proven to stop a passenger car 13 metres quicker than OEM pads from 100mph/160kph. Features EBC Brake-In surface coating which conditions disc surface and accelerates pad bed-in. Nominal friction coefficient 0.5 with approx. 50% dust reduction. Most EBC Red Ceramic pads are approved to ECE R90 brake safety regulation.



XK8 4.0 and 4.2 except ,R' performance options (Brembo brakes) to VIN...A48684

Part no. 497395

XK8 4.0 and 4.2 with ,R' performance options (Brembo brakes) from VIN...A00083 to A48684

Part no. 497397

XK8 3.5 and 4.2 except models with Alcon brakes from VIN...B00379 to B32752, XK8 5.0 except Supercharged and models with Alcon brakes from VIN...B32753

Part no. 497399



1. COMPETITION PARTS

18. COIL SPRINGS

this 4 piece kit will lower your vehicle by 10mm. These units are a perfect option for either the daily driver or the serious race enthusiast. The lowering extent is compatible with the original shocks and therefore stiffer dampers are not required

XK8 4.0 and 4.2 to VIN...A48684

Part no. 497149

- Motorsport materials used for durability
- Lower sporty stance for more road presence
- Precision engineered design
- Everyday usability not compromised
- Fully tested on vehicle under many conditions
- Approved by German TUV
- Fits to all XK8/XKR including models with adaptive control damping (C.A.T.S)



19. WIND DEFLECTOR

two-piece tubular steel frame covered with a special mesh fabric, hemmed with high quality synthetic black leather, stowable

XK8 4.0 and 4.2 Convertible to VIN...A48684

Mounting: Drill and "snap in"

Part no. 278584

XK8 3.5 and 4.2 Convertible from VIN...B00379 to B32752, XK8 5.0 Convertible from VIN...**B32753**

Mounting: „snap in“ to the original holder

Part no. 494088

Now is your chance to extend the open-top driving season: With our wind deflector you eliminate turbulence in the interior of your car while noticeably reducing neck and ear discomfort. Choose a high quality product, precision crafted in Europe - our specially woven material guarantees the utmost stability and a long service life over a wide temperature range (-30 to +90 degrees Celsius).

Main features of our wind deflectors:

- perfect tailored fit for your make and model
- allows for conversation at normal sound level and improves acoustics for your ICE and hands-free kit
- simple to install
- the roof can be opened and closed with the deflector in place



1. SPECIAL TOOL

for the variable valve timing

**XK8 4.0 to VIN...A30644,
XK8 4.2 von VIN...A30645 bis B32752,
XK8 3.5 from VIN...B00379 to B32752,
XK8 5.0 from VIN...B32753**
Part no. 220418



2. SPECIAL WRENCH

for front pulley locking

**XK8 4.0 to VIN...A30644,
XK8 4.2 from VIN...A30645 to B32752,
XK8 3.5 from VIN...B00379 to B32752,
XK8 5.0 from VIN...B32753**
Part no. 217104



3. ADAPTOR

for pulley locking wrench 217104

**XK8 4.0 except Supercharged to VIN...A30644,
XK8 4.2 except Supercharged from
VIN...A30645 to B32752,
XK8 3.5 from VIN...B00379 to B32752,
XK8 5.0 except Supercharged from VIN...B32753**
Part no. 496693

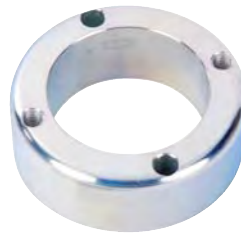

**XK8 4.0 Supercharged to VIN...A30644,
XK8 4.2 Supercharged from VIN...A30645 to
B32752,
XK8 5.0 Supercharged from VIN...B32753**
Part no. 496694

4. SPECIAL TOOL

for camshaft setting and locking

**XK8 4.0 to VIN...A30644,
XK8 4.2 von VIN...A30645 bis B32752,
XK8 3.5 from VIN...B00379 to B32752,
XK8 5.0 from VIN...B32753**
Qty. required: 2Part no. 219421



2. SPECIAL CAR TOOLS

5. SPECIAL TOOL

for the timing chain tensioners

XK8 4.0 to VIN...A30644,
XK8 4.2 von VIN...A30645 bis B32752,
XK8 3.5 from VIN...B00379 to B32752,
XK8 5.0 from VIN...B32753
 Part no. 220385



5.

6. WEDGE

for timing chains - supplied in pairs

XK8 4.0 to VIN...A30644,
XK8 4.2 von VIN...A30645 bis B32752,
XK8 3.5 from VIN...B00379 to B32752,
XK8 5.0 from VIN...B32753
 Part no. 220387



6.

7. SPECIAL TOOL

for crankshaft locking

XK8 4.0 to VIN...A30644,
XK8 4.2 from VIN...A30645 to B32752,
XK8 3.5 from VIN...B00379 to B32752,
XK8 5.0 from VIN...B32753
 Part no. 219475



7.

8. PULLER

for crankshaft pulley

XK8 4.0 to VIN...A30644,
XK8 4.2 von VIN...A30645 bis B32752,
XK8 3.5 from VIN...B00379 to B32752,
XK8 5.0 from VIN...B32753
 Part no. 220396



8.

9. BALL JOINT SEPARATOR

for ball joints from 19 to 22 mm. Adjustable heavy duty type

XK8 4.0 to VIN...A30644,
XK8 4.2 von VIN...A30645 bis B32752,
XK8 3.5 from VIN...B00379 to B32752,
XK8 5.0 from VIN...B32753
 Part no. 302057



10. REMOVER

for front hub

XK8 4.0 to VIN...A30644,
XK8 4.2 from VIN...A30645 to B32752,
XK8 3.5 from VIN...B00379 to B32752,
XK8 5.0 from VIN...B32753
 Part no. 496696



11. PULLER

for rear hub

**XK8 4.0 to VIN...A30644,
XK8 4.2 from VIN...A30645 to B32752,
XK8 3.5 from VIN...B00379 to B32752,
XK8 5.0 from VIN...B32753**
Part no. 272906



13. PLIERS

for the removal and replacement of metal or plastic spring-loaded hose clamps. Ideal for working in confined engine bays. Flexible long reach mechanism allows the pliers to release and lock hose clamps in the opened position. Fitted with 630 mm long cable. For clamp diameters from 18 mm to 53 mm.

XK8 4.0 to VIN...A30644, XK8 4.2 von VIN...A30645 bis B32752, XK8 3.5 from VIN...B00379 to B32752, XK8 5.0 from VIN...B32753
Part no. 495853



12. PULLER

for ABS timing rotor

**XK8 4.0 to VIN...A30644,
XK8 4.2 from VIN...A30645 to B32752,
XK8 3.5 from VIN...B00379 to B32752,
XK8 5.0 from VIN...B32753**
Part no. 220585



Visit our Online Shop: www.Limora.com



3. WORKSHOP TOOLS

1. SOCKET SET

metric and imperial

Draper Expert Hi-Torq™ sockets have 6 or 12 corners with a special radius design giving added torque. With this design Draper extends the life of the socket and fastener. These sockets have a hole for positive ball retention in accordance with DIN 3120 specification. Expert quality socket set manufactured from chrome vanadium steel hardened, tempered, chrome plated and polished for corrosion protection. Packed in blow mould carrying case and display.

- 41 piece. 1/2" square drive Part no. 311692
- 40 piece. 3/8" square drive . . . Part no. 306849
- 75 piece. 1/4" square drive Part no. 214942



2. GEAR WRENCH SET

gear wrench open end with 15° offset, ratchet end with 180° flexible head and 5° ratchet mechanism. Chrome vanadium steel, hardened, chrome plated, polished.

- 7 piece set with 10, 12, 13, 14, 15, 17 and 19 mm wrenches
Part no. 24487
- 10 piece set with 8, 10, 12, 13, 14, 15, 17 and 19 mm wrenches. As a special feature the wrenches can be converted to a 1/4" and 3/8" drive
Part no. 244338



3. COMBINATION SPANNER SET

made from forged from chrome vanadium steel. Comes with tool bag

- 11 piece set with 6, 7, 8, 9, 10, 11, 12, 13, 14, 17 and 19 mm wrenches
Part no. 218960
- 14 piece set with 8, 9, 10, 11, 12, 13, 14, 17, 19, 22, 24, 27, 30 and 32 mm wrenches
Part no. 319635



4. COMBINATION SPANNER SET

heavy duty edition, 1.5 times thicker as standard spanners to transport maximum torque!
14 pieces multi colour set with 6, 7, 8, 9, 10, 11, 12, 13, 14, 15, 16, 17, 18 and 19 mm wrenches
Part no. 464592

5. POCKET WRENCH

spring loaded adjustment, works like a pocket knife and allows the correct size to be used every time. Small enough to fit into your pocket, and packed in a sturdy material pouch. Special spacer blades lift into place for a snug fit that eliminates the play of most adjustable wrenches. 18 metric sizes range from 8 to 25mm. Folds down to an incredible 5 x 2 x 3/4". Ideal for: cars, boats, caravans, motorcycles, trucks and kitchen drawers. Part no. 487863



6. TOOL ROLL

made from dark brown leather with 17 high quality tools

Content: 7 metric Open end spanner (6x7, 8x9, 10x11, 12x13, 14x15, 16x17, 18x19), 1 monkey wrench with 150 mm length, 1 combination pliers, 1 slot and 1 cross slot screwdriver, 1 contact file, 1 brass wire brush, 1 feeler gauge, 1 circuit testing lamp, 1 pocket knife, 1 pair of working gloves. Part no. 489698



7. TORQUE WRENCH

with 1/2" square drive, adjustable from 28 to 210 Nm, length: 465 mm, supplied with plastic box

Torque wrench with reversible ratchet head. The lb-ft and Nm scale is engraved on the barrel of the wrench. The micrometer type sleeve allows accurate preset torque values to be set. When torque is reached the wrench produces an audible click and a release of tension. Part no. 311625



8. TORQUE WRENCH ADAPTOR

40-200 Nm with 1/2" drive to use every ratchet or tee bar as torque wrench. Digital display, acoustic and optical signal when torque is reached. Part no. 490061



„Valve devil“

9. LIMORA VALVE GRINDER

good performance depends on properly seated valves. Badly seated or burnt valves and worn guides and stems result in hot gas escaping under compression, reducing performance and increasing engine wear. Loss of power and poor starting are some of the symptoms. The oscillating valve lapper produces gas tight seals in seconds and converts a standard rotary drill to oscillating action/grinding motion. The 22/28 mm suction heads fit most valves, an essential tool for multi-valve engines. Part no. 321353



10. CHEMICO VALVE GRINDING PASTE

double ended tin with oil based grease and silicon carbide containing coarse and fine grades

110 gram can Part no. 489363



3. WORKSHOP TOOLS

11. NUT SPLITTER

with chromed surface supplied in a 3 piece set. From 9 to 22 mm. Part no. 317014



Expert quality, manufactured from chrome vanadium steel with square drive ends

9 to 12 mm, length: 80 mm . . . Part no. 328862
 12 to 16 mm, length: 105 mm. . . Part no. 328863
 16 to 22 mm, length: 130 mm . . Part no. 328864

12. HAND TAP

supplied in a 10 piece metric set. Manufactured from special high carbon steel with accurately cut threads. Contents tabs from 3 to 12 mm Part no. 287485



13. MAGNET HOLDER

flexible with 540 mm length. The best one we could find! Capable of lifting over 3 pounds Part no. 371962



14. GREASE GUN

new 2 handle system for 500 g cartridges, easy, mess free cartridge change, easy to gauge amount of grease remaining. Part no. 220563



15. GREASE

LZR 2 longlife grease is a new grease for roller and friction bearings, that is made from high quality basic oils by using lithium soaps as thickening agents. It shows an extraordinary oxidation resistance. LZR 2 grease is water resistant, adhesive, can be loaded with pressure and is protective against corrosion. These properties, in connection with high work resistance, very good abrasion rating and particularly strong adhesive quality, characterise this lubricant as particularly appropriate for lubrication under difficult operating conditions and at highly loaded roller and friction bearings. Practical advantages: LZR 2 can be used universally as a long-term grease. It is recommended for lubrication of vehicles, industrial machinery and for all machines and devices in the field of construction, stone and earth. Temperature range: -30° to +120°C.

500 gram cartridge
 Part no. 305693



16. IMPACT WRENCH

with 1/2" drive. Contents: ten impact nuts from 9 to 27 mm, one 5" extension bar, one mini oiler, one nipple. Tech. data: 6.3 bar operating pressure, 310 Nm maximal torque, 7.000 rpm free speed Part no. 488134



17. SOCKET

46 mm for 1" drive - for the removal of ball joints
Part no. 493698



18. ADAPTOR

for socket 493698 - reduces 1" to 3/4" drive
Part no. 493700



19. TACHOMETER

digital gauge with Laser RPM pick up. With 5 digit LCD-display and a measuring range from 0,1 up to 19999 RPM, accuracy: +- 0.05%+1 RPM. The built in memory saves min. and max. RPM and the last measured value. Needs four 1.5V AA batteries, not included. With this special meter all rotating parts can be checked. Great diagnostic tool for gearbox, final drive and many other applications on automotive service and repair.
Part no. 221361



20. THERMOMETER

now with an easy-to-use pistol design and illuminated display. Suitable for a lot of tasks around the car and workshop. Check the temperature of the engine, muffler, tyres and brakes. Which cylinder is getting hot? A fast detection of faulty components can save time and prevent expensive repairs and severe damage. 9V battery included.
Part no. 306497



21. BATTERY

infrared thermometer 306497 (ill. 21)
Part no. 471684



22. MULTIMETER

digitally, shows: dwell, rpm, voltage, resistance, amps.
Digital multimeter with a rotary switch for selection of the 24 different functions and ranges. Suitable for the measurement of DC volts and amps, resistance, dwell, rpm on 4, 6, 8 and 12-cylinder engines. The testing of diodes is also possible. The shock resistant housing is made of rubber. Supplied with 2 sets of cables: one pair with crocodile clamps and one pair with probes. A 9 V block battery and vinyl storage bag is included.
Part no. 314833



3. WORKSHOP TOOLS

23. SCREWDRIVER

with flexible shaft, 170 mm long

- for 5 mm hose clips Part no. 245951
- for 6 mm hose clips Part no. 245955
- for 7 mm hose clips Part no. 245956
- for 8 mm hose clips Part no. 245957
- for 10 mm hose clips Part no. 246045



23.

24. GUNSON'S LAMBDA SENSOR TESTER

with a fast 20 segment LED display covering a range from 0 to 1 volt. Suitable for cars with electronic fuel injection and catalytic converters. Also useful for testing the ECU injection control unit. Can be simply connected to the on board 12 volt battery with the 2 crocodile clamps. Prevents catalytic converter damage and provides an optimal fuel/air mixture. Part no. 245164



24.

25. LAMBDA SENSOR CHASER

for cleaning and restoring the sensor bore threads, M18 x 1.5 mm. Can be installed using spark plug wrench or 21 mm socket. Part no. 471256



25.

27. GUNSON'S GAUGE

for simple wheel alignment, simple testing with modern laser technology

This wheel alignment gauge quick and easy diagnosis of a vehicles front wheel alignment (toe angle) on upto 22" wheels in degrees and minutes, accurate to 0.01 degree (0.0166 decimal degrees) 60' (minutes) - 1 degree. Designed to work on the wheel rims. Batteries not included. This gauge allows anyone to check the tracking on their car without paying up to £25 for the check. Having correctly aligned tracking saves money on fuel and tyre wear. Process self calibrates after each use. Patent pending. Static tracking system utilising laser light technology. Any adjustments to the vehicles must be done by a competent person with reference to the manufacturer's recommendations and relevant service and repair manual.

Part no. 495649



27.

26. OIL FILTER WRENCH

universal, for oil filters from 53 mm to 118 mm. Part no. 301175



26.

1. PARKING SIGN

made from 18 gauge steel, with embossed 'Jaguar parking only' script in gold on green surface, size: 18 x 11.7/8"

Part no. 488717



2. PARKING SIGN

made from 18 gauge steel, with embossed 'Jaguar parking only' script in white on red surface, size: 11.7/8 x 18"

Part no. 488721



3. TYRE VALVE CAPS

chromed with golden 'Jaguar leaping cat' on green surface

Supplied in sets of 4. Part no. 251195



4. TYRE VALVE CAPS

chromed with white 'Jaguar' head on green surface

Supplied in sets of 4. Part no. 446790



5. TYRE VALVE CAPS

chromed with Union Jack logo

Supplied in sets of 4. Part no. 478517



6. JAGUAR TEDDY BEAR

in brown, with flying jacket, goggles and white T-shirt with red 'Jaguar' logo

Part no. 489083



Secured against theft by simply tightening a screw on the side of the caps.
Allen wrench included!



4. ACCESSORIES

7. KEY RING

this key ring is inspired by the Jaguar gear selector. Like the gear selector, this key ring features the same clean circle shape and chic colour. Makes an excellent gift for the Jaguar enthusiast in your life

Part no. 496579



8. KEY RING

this key ring is inspired by the Jaguar gear selector. Like the gear selector, this key ring features the same clean circle shape and chic colour. Makes an excellent gift for the Jaguar enthusiast in your life

Part no. 496581



9. KEY FOB

with chromed 'Jaguar Leaping Cat' motif with 50 mm total length, supplied with a drawstring pouch

Part no. 327649



10. JAGUAR KEY FOB

with chromed 'Jaguar' Logo on black surface, supplied with a drawstring pouch

Part no. 489072



11. KEY FOB

'Jaguar' head, black leather, 40 mm x 85 mm

Part no. 356383



12. KEY FOB

'Jaguar Leaping Cat', black leather, 40 mm x 85 mm

Part no. 206848



13. COFFEE MUG

in white with 'Jaguar Leaping Cat' logo in black

Part no. 272413



14. JAGUAR UMBRELLA

with a 130 cm span when fully open, colour: black. Made from lightweight aluminium. The white Jaguar logo has been printed on alternate panels

Part no. 318709



15. JAGUAR UMBRELLA

with a 130 cm span when fully open, colour: white/black. Made from lightweight aluminium. The red Jaguar Heritage logo has been printed on alternate panels

Part no. 490376



16. JAGUAR CAR COVER

tailored specifically for your XK8, this durable outdoor cover helps protect your Jaguar from rain, dust and other elements. Includes a convenient storage bag

XK8 4.0 to VIN...A30644, XK8 4.2 von VIN...A30645 bis B32752, XK8 3.5 from VIN...B00379 to B32752, XK8 5.0 from VIN...B32753
Part no. 393260

MATERIAL STRUCTURE



outer side

inner side



4. ACCESSORIES

17. CAR COVER

our Car covers are made from high quality materials to ensure that your quality expectations will always be met and surpassed. We use the latest generation materials, double stitching, durable securing straps and purpose made fittings. We have a wide range of cover materials available. There is a blue indoor cover available and a heavy duty grey outdoor cover. The breathable indoor dust cover is manufactured from a thick non-woven material in a royal blue colour. It is breathable and 100% UV resistant to protect paintwork and prevent colour fade and comes with elasticated hems and underbody straps for a snug fit. This type of car cover will not deposit fluff on mohair or canvas hooding material and is both machine and hand washable. The heavy duty outdoor cover comes with a soft lining to protect paintwork. It is a substantial cover weighing about 3 kg and packed in a sturdy zipped storage bag with handles. The grey coloured outer skin is soft and pliable, yet totally waterproof, and the stitched seams are heat sealed.

grey
XK8 4.0 and 4.2 to VIN...A48684
 Part no. 318063

blue
XK8 4.0 and 4.2 to VIN...A48684
 Part no. 496678

grey
XK8 3.5 and 4.2 from VIN...B00379 to B32752,
XK8 5.0 from VIN...B32753
 Part no. 496677

blue
XK8 3.5 and 4.2 from VIN...B00379 to B32752,
XK8 5.0 from VIN...B32753
 Part no. 496679

OF COURSE YOU CAN ORDER COLOUR SAMPLES FOR FREE UNDER FOLLOWING PART NUMBERS:

COLOUR SAMPLE

grey outdoor car cover
 Part no. 355026

blue indoor car cover
 Part no. 491710

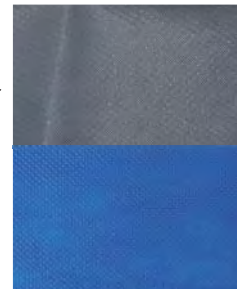

18. DUSTER

made of 100% soft cotton. Lifts dust without scratching the paint. Expandable plastic grip

Part no. 318723

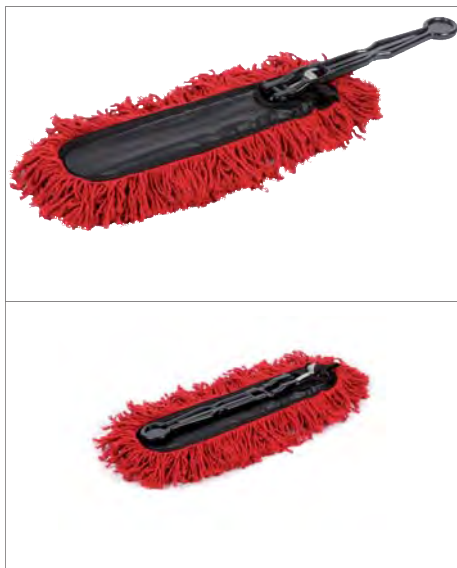

19. OIL DRIP MAT

sizes: 90 x 120 cm, oil consumption: 4 litre

Part no. 355878



20. STOOL

with Union Jack print, connector system made of robust plywood, dimensions: 42 x 29,5 x 29,5 cm, stool load: 150 kg

Part no. 496486

Is your stool still cool?
 Always new, always surprising, always different - unexpected things do not miss out but getting into the spotlight: The Werkhaus PHOTOHOCKER! Stable wood-based panels (MDF), furnished with high-resolution digitalprints and protected by an UV-hardening lacquer, connecting themselves through the original Werkhaus connection-system to a durable seating furniture.



21. SWIZÖL MASTER COLLECTION

The Swizöl Master Collection is the ultimate in organisation combining convenience and practicality. Leather seats, wood, plastics, vinyl, wheels, tyres, chrome, brass, nickel, glass ... the Master Collection will enhance every detail of your automobile to stunning and perfect Concours standard. Includes: Cleaner Fluid (pre-wax treatment) 250 ml Cleaner Fluid medium (scratch remover) 250 ml, Paint Rubber (clay bar), Quick Finish (quick detailing fluid) 250 ml, Car Bath (wash concentrate) 250 ml, Wheel (wheel cleaning concentrate) 250 ml, Mixing Bottle (spray bottle) 250 ml, MicroWash microfibre, Pneu (tyre dressing) 250 ml, Protecton (plastic restorer) 250 ml, Leather Cleaner 250 ml, Leather Milk 250 ml, Leather Cleaning brush, Metal Polish (chrome, aluminum) 50 ml, Wood Polish 50 ml, Autobahn wheel wax with PTFE 50 ml, Crystal (glass cleaner) 250 ml, 2 applicators (for wax and Cleaner Fluid), 3 towels, MicroPolish microfibre towel (blue), special brushes, Swizöl handbook, Cooler-Bag (isolating temperature) with variable dividers.

with German labelling
Part no. 487054

with English labelling
Part no. 330012



Please combine the Master Collection with the wax of your choice.

22. SWIZÖL ONYX WAX

Swizöl Standard wax. The perfectly balanced oil concentration prevents hazing, produces a brilliant, streak free gloss. 30 Vol-% of pure yellow Grade One Brazilian carnauba wax gives colours protection from scratches caused by dust and washing. Use after applying Cleaner Fluid. Enough for 20 wax treatments of a sedan.

with German labelling
Part no. 487060

with English labelling
Part no. 329961



23. SWIZÖL MIRAGE WAX

Swizöl Premium wax for all colours. Contains a high concentration of ultra pure Brazilian grade one carnauba (over 40% by volume) and is enriched with coconut and avocado oil extracts. Mirage is an excellent choice for an enhanced shine and a varnish protection making a longer impression. Produces a brilliant streak-free gloss. Use after applying Cleaner Fluid. Enough for 20 wax treatments of a sedan.

with German labelling
Part no. 487061

with English labelling
Part no. 329971



24. SWIZÖL CONCORSO WAX

The most famous Swizöl special wax for deeply reflecting and repletely shiny surfaces. Applying Concorso wax will lead to a breathtaking effect due to 50 Vol.-% of pure, yellow Brazilian Grade One carnauba. Use after applying Cleaner Fluid. Enough for 20 wax treatments of a sedan.

with German labelling
Part no. 487062

with English labelling
Part no. 329972



4. ACCESSORIES

25. LETTER OPENER

with chromed ,Leaping Cat' motif,
length: 183 mm

Part no. 492860



26. BOTTLE OPENER

with chromed ,Leaping Cat' head.
Size: 90 x 65 x 65 mm, weight: 550 g

Part no. 490288



27. BOTTLE OPENER

with chromed ,Leaping Cat' motif,
size: 75 x 15 x 15 mm, weight: 40 g

Part no. 489076



28. CORKSCREW

Leaping Cat, polished chrome, size: 120 x 90 mm

This elegant corkscrew is crafted from a leaper motif, an ideal gift for any Jaguar enthusiast.

Part no. 485558



29. PAPERWEIGHT

with chromed ,Leaping Cat' motif on chromed base

length: 80 mm Part no. 485562

length: 140 mm Part no. 485556



30. PAPERWEIGHT

with chromed ,Leaping Cat' motif on finest wooden mahogany socket, length: 125 mm

Part no. 318128



31. BASEBALL CAP

with Jaguar script. Made from polyester, colour: black with contrast white line around the fabric covered peak

Part no. 493848



32. BASEBALL CAP

with white Jaguar logo. Made from polyester colour: green with contrast white line around the fabric covered peak

Part no. 318708



33. BASEBALL CAP

with white Jaguar logo. Made from polyester, colour: black with contrast white line around the fabric covered peak

Part no. 272338



34. WING COVER

green padded and emblazoned with the leaping cat. Size: 90 x 50 cm

Made from nylon, washable. Doesn't scratch paintwork because of supersoft anti-slip surface on underside. No magnets inside.

Part no. 487962



35. WING COVER

green padded and emblazoned with the leaping cat. Size: 90 x 55 cm

Part no. 317948



36. WING COVER

made of soft red cotton cloth. The built in magnets fix the cover to the wing. Suitable for the use with any vehicle. Protection against dirt and scratches. Size: 100 x 57 cm

Part no. 318071



4. ACCESSORIES

37. SEAT COVER

green padded and emblazoned with white leaping cat. Size: 130 x 75 cm, nylon-fabric, washable. British racing green, protects seats from dirty working clothes

Part no. 487963



38. LUSTER LACE POLISHING STRIPS

Luster Lace polish strips are designed to work on all round and tubular metal surfaces. The polish is in the cloth of the strips, no other utilities are needed to get the perfect finish. Luster Lace is fast and easy to use with 360° polishing power that can't be beat. So now you can save up to 70% of your work time. Luster Lace comes in three convenient sizes (narrow, medium, wide) for the care of parts of all sizes.

- Luster Lace Narrow - for wire wheels and filigree parts
- Luster Lace Medium - for headlamp rims, tubular manifolds etc.
- Luster Lace Wide - for large diameters like silencers
- Luster Lace Combo - complete assortment, for all parts

“Narrow“

Content: 14 strips 1/2“ wide
Part no. 485441

“Medium“

Contents: 9 strips 25/32“ wide
Part no. 227633

“Wide“

Contents: 6 strips 1.3/16“ wide
Part no. 378882

“Combo“

Content: 4 strips 1/2“ wide, 3 strips 3/4“ wide and 2 strips 1.1/4“ wide
Part no. 485440



39. USB MEMORY STICK

4 GB, as Classic Jaguar E-Type shape model in silver

Part no. 496583



40. MOUSE

a wireless computer mouse with a USB receiver, using the latest technology. Shaped like a Jaguar XKR with phosphor blue working headlights

Part no. 496582



41. JAGUAR BALLPOINT PEN

in a black leather case with subtle blue stitching
Part no. 493847



42. PRYMOS® FIRE EXTINGUISHER SPRAY

'Auto & Bike', AB foam against incipient fire.
The extinguishing capability is (21B/3A)

580 ml spray can Part no. 494103

Prymos Fire Extinguisher Spray is designed for extinguishing fires in cars, in truck cabs, mobile homes as well as motorcycles and can be used with electrical appliances charged up to 1000 volts. It can be carried in the car or stored in the garage at temperatures from -15 °C to +60 °C max. Applications: tires, trailers, motors, polymers, liquid fuels, paper and cardboard.



43. NET POCKET

for boot area - for maps, gloves, etc.
Size: 32 x 14 cm

Part no. 494474



5. BOOKS

1. JAGUAR

The complete chronicle from 1922 till today. Written by Heiner Stertkamp, 420 pages with 1.000 coloured illustrations, size: 280 x 280 mm, binding: hardcover

This is the first book to combine exhaustive research about the vehicles and a full history of the company in one volume - everything from different machines, models, racing drivers, wins and losses on the racetrack, production, plus an extensive specifications index. Heiner Stertkamp is a renowned Jaguar expert and enthusiast, and has enjoyed full access to the Jaguar Daimler Heritage Trust archives in writing this book. This makes it the most complete, detailed history of Jaguar today, a book sure to become a classic and received warmly by any interested reader, taking pride of place on their bookshelves.

German Part no. 437021
English Part no. 496445



2. JAGUAR XK8 AND XKR

plus XK180 and F-Type Concept. Written by John Blunsden. 128 pages with 138 coloured illustrations, size: 195 x 139 mm, binding: paperback, language: English

The XK8 and XKR have brought Jaguar back to the heart of the luxury sports car market with a series of elegant Coupes and Convertibles which have proved consistent best sellers throughout the world. This work examines the XK heritage through to the famous E-Type and then traces Jaguar's return.

Part no. 295367

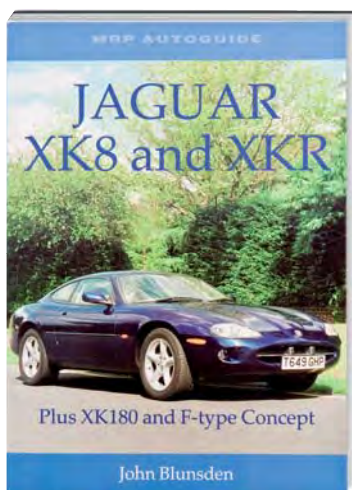

3. JAGUAR XK8 AND XKR

Performance Portfolio, 1996-2005. Written by R.M. Clarke, 128 pages with many illustrations, size: 270 x 200 mm, binding: paperback, language: English

Jaguar's E-Type was so good that designing and developing a successor was always going to be difficult. The XK8, released in 1996, brought renewed credibility to Jaguar Cars. It looked like a Jaguar should - sleek, low with sensuous curves in all the right places. Three years later Jaguar announced the XKR, a supercharged and honed-and-tightened version of the XK8. Various special XKs were built during its long production life and it had a 'sister' car in the lovely Aston Martin DB7 that took features from both it and the XJ-S. The XK8 remained in production until 2005 when it was replaced by the next generation that borrowed heavily from it.

Part no. 496091

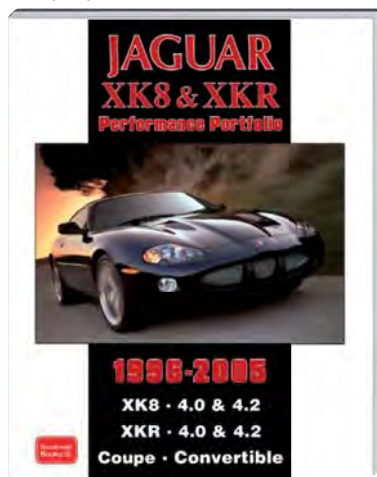

4. ROAD & TRACK

Jaguar XJS, XK8 and XKR Portfolio 1975-2003. Written by R.M. Clarke, 128 pages with many illustrations, size: 270 x 200 mm, binding: paperback, language: English

A Brookland book from the Road and Track series. Official reprints of the original articles taken from America's most popular motoring magazines. This book contains hard-to-find articles on Jaguar XJ-S, XK8 & XKR, including road tests, new model reports, comparisons, specs, performance data & more.

Part no. 496090

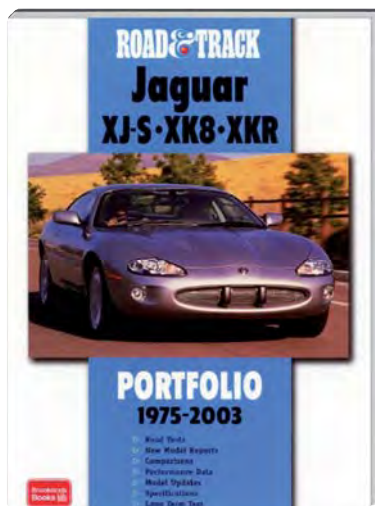

5. JAGUAR XK8

The Complete Story. Written by Graham Robson, 176 pages with 146 coloured illustrations, size: 246 x 189 mm, binding: hardcover, language: English

It was code-named X100 and it was to be Jaguar's latest sports cars, featuring both coupe and convertible coachwork. It was to have an all-new V8 engine and it was to replace the XJS. It would also ultimately have the most powerful forced-induction engine of any production Jaguar road car and it had a lot riding on its success. It was the XK8 - a sleek, purposeful grand tourer in the Jaguar tradition.

Graham Robson, one-time Jaguar apprentice and a motoring historian with several other Jaguar books to his credit, tells the story of one of the twentieth century's most beautiful sports cars, from its conception to the end of the line for both it and the factory it was built in. Topics covered: Full history of the XK8 Special feature panels on key personalities and developments Full specifications of each model.

Part no. 496092

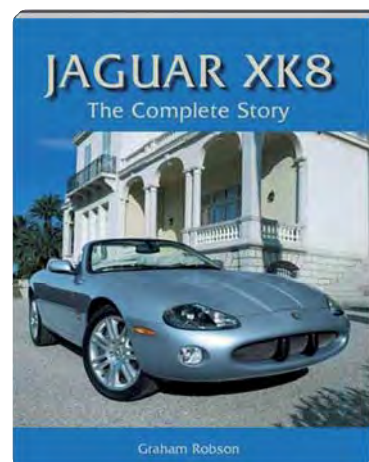

6. JAGUAR

written by Marco Guidetti, 188 pages with 280 illustrations, size: 125 x 190 mm, binding: hardcover, language: German

The cats from Conventy are more successful than ever. The roots of success go back to the year 1931 as the first Jaguar rolled off the assembly line. This volume examines the background to the emergence of the SS1 to the latest XK. Thanks to a large number of previously unpublished photos and insider information about the reader can relive Jaguars sporting history.

Part no. 496987



7. JAGUAR XK8 AND XKR

The Essential Buyer's Guide
Written by Nigel Thorley. 64 pages with 100 coloured illustrations, size: 195 x 139 mm, binding: paperback, English

For anyone with an interest in, or who is thinking of buying, one of the already classic Jaguar XK8 sports cars from the 1996 to 2005 period, this Essential Buyer's Guide is a vital requirement. All the models are covered, from the early 4.0-litre models with the infamous Nikasil engines, through to the very last and highly sophisticated 4.2-litre S, with mention of the special editions available in selected markets. A handy pocket-sized guide, that will always be at your side for constant reference.
Part no. 493200

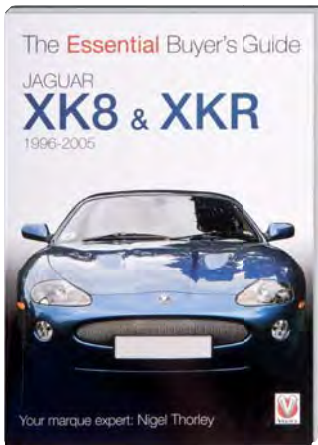

8. JAGUAR

All the cars
Written by Nigel Thorley, 320 pages with 500 coloured illustrations, size: 233 x 169 mm, binding: hardcover, language: German

This extensively researched guide provides exhaustive reference detail for all post-war Jaguar models, supported by facts, figures and photographs, from the Mark V saloon through to the latest X-Type, S-Type, XK and XJ models. Information provided includes technical specifications, production changes, chassis numbers, production quantities, colour schemes, options and accessories. For ease of reference, each model is dealt with in a separate chapter, and all information is presented in clear tabular form.

German Part no. 495762
English Part no. 492789

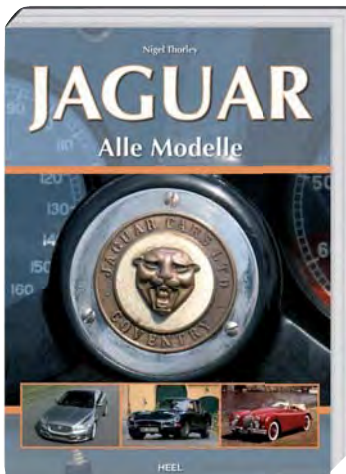

9. JAGUAR

The impressive portrait of the Jaguar marque.
Written by Bernard Viart and Serge Bellu, photos by Xavier de Nombel, 208 pages with 223 coloured and 28 b/w illustrations, size: 300 x 240 mm, binding: hardcover, language: German

The authors Viart and Bellu describe in this book the history of Jaguar. More than 100 types and 34 models are portrayed in words and pictures. They fit together to form a complete picture of the car brand.

The authors describe in great detail how each model is developed historically and how it is technically and aesthetically advanced. What proportion of the individual managers, engineers, technicians and designers had is discussed in detail. The authors also tell the often incredibly complex history of these individual vehicles. Special consideration is given to the ultimate Jaguar XK and the development of the V12 engine. The racing history of Jaguar is presented in detail.
Part no. 495737

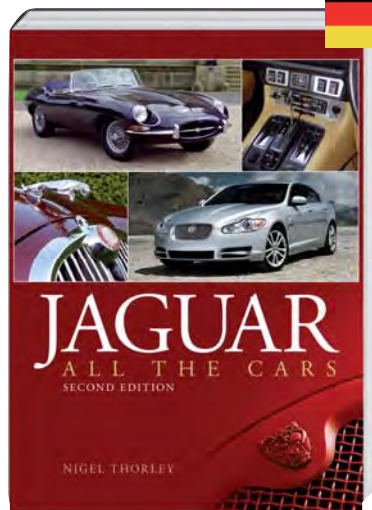

10. JAGUAR COUPES 1932-2007

75 years of luxury and passion
Written by Matthias Pfannmüller, 176 pages with 220 coloured photos, size: 230 x 290 mm, binding: hardcover, language: German

The cats from Coventry always have an excellent reputation. But the true roots of success lie in the past. This book is dedicated to the noble two-doorer and for the first time a detailed view of ten series over 8 decades. The background to the development of SSI to the current XK is analyzed, as well as technology and equipment. At the same time, the entire brand history is represented competently. Using many previously unpublished photos and insider information the reader can relive the eras of Jaguar Coupes, travelling in style through the varied models and contemporary history. Entertainingly written texts, and an elegant layout makes this book a real pleasure for Jaguar enthusiasts.
Part no. 488373



11. TYPE GUIDE

Jaguar cars since 1931
Written by Halwart Schrader, 128 pages with many photos, size: 205 x 140 mm, binding: paperback, language: German

The cats from Coventry are more successful than ever. This success was initiated by the change of the S-Type in 1996 but the roots of success lie in the distant past from the first Jaguar in 1931. Halwart Schrader has produced a comprehensive but concise treatment of the entire range of sports cars, coupes, saloons and convertibles.
Part no. 486391

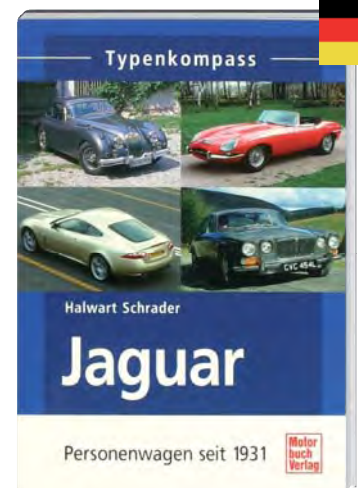

If you are searching for a special book which you did not find you can contact us:

E-Mail:
Buchladen@Limora.com

We will get you any book about classic cars.



Jaguar's recommendation:

26. CASTROL FULL SYNTHETIC OIL

Edge SAE 0W/30

XK8 4.0 and 4.2 including Supercharged to VIN...A48684, XK8 3.5 and 4.2 except Supercharged from VIN...Boo379 to B32752
5 litre canister Part no. 495413

Product features:

- Best oil for modern high performance engines
- Lower fuels consumption
- Fully synthetic technology

Product benefits:

- Improves engine performance even through extended service intervals
- Easier to start in all weather
- Protects from the moment you start the engine
- Improves acceleration
- Reduces fuel consumption leading to lower running costs
- Reduces engine wear – peace of mind against breakdown

Technical specifications and approvals:

- ACEA A3/B3, A3/B4
- API SM/CF
- BMW Longlife-01
- GM-LL-A-025, GM-LL-B-025
- MB-Approved 229.3, MB-Approved 229.5
- VW 502 00 / 503 01 / 505 00

27. CASTROL FULL SYNTHETIC OIL

Magnatec SAE 5W/30 C3

XK8 4.2 Supercharged from VIN...Boo379 to B32752
5 litre canister Part no. 472241

Castrol Magnatec 5W-30 A3/B4 intelligent molecules cling to critical engine parts to provide an extra layer of protection. With up to 75% of engine wear happening whilst your engine's warming up, Castrol Magnatec's molecules are always there, always ready, drastically reducing* engine wear during this critical start-up and warm-up period.

Castrol Magnatec 5W-30 A3/B4 combining Intelligent Molecules and fully synthetic technology: Clings to your engine forming an extra layer that protects during warm-up and beyond Bonds to metal surfaces making engine parts more resistant to wear Combine with synthetic technology to provide increased protection in high and low temperature applications

Provide continuous protection for all driving conditions, styles and temperatures Provides superior performance under extreme cold start up conditions.

Technical specifications and approvals:

- API SM/CF
- ACEA A3/B3, A3/B4, C3
- GM-LL-A-025
- GM-LL-B-025
- BMW approval Longlife-01
- MB approval 229.31
- RENAULT approval RN0700
- VW approval 502 00 u. 505 00
- FIAT approval 9.55535-G1
- JAGUAR approval WSS-M2C913-B

28. CASTROL FULL SYNTHETIC OIL

Edge SAE 5W/20

XK8 5.0 including Supercharged from VIN...B32753
5 litre canister Part no. 495654

Castrol was the first major oil brand to offer a full synthetic 5W-20 that is specifically formulated to meet the needs of Jaguar, Land Rover, Ford, Chrysler, Honda and Toyota 5W-20 service. EDGE 5W-20 provides excellent cold weather performance and exceeds the stringent performance, fuel economy and fuel economy retention requirements of the ILSAC GF-4 specification. EDGE 5W-20 meets the needs of Ford, Honda, Toyota, Chrysler, Dodge, Hyundai and other vehicles where 5W-20 is recommended. EDGE 5W-20 also exceeds all the requirements of ILSAC GF-4 and GF-3 for API Certified Gasoline Engine Oils.

Technical specifications and approvals:

- ACEA A1/B1
- API SL
- Meets Ford WSS-M2C925-A and Ford WSS-M2C925-B
- Meets engine test requirements of A5/B5
- ILSAC GF-3



engine capacity: 6 to 8.5 litre. Depends on engine size

6. OILS, LUBRICANTS, FLUIDS AND ADDITIVES

4. AUTOMATIC GEARBOX OIL

XK8 4.0 except Supercharged to VIN...A30644
1 litre bottle Part no. 421900

gearbox capacity: **10 litre**



5. AUTOMATIC GEARBOX OIL

XK8 4.0 Supercharged to VIN...A30644
1 litre bottle Part no. 348154

gearbox capacity: **10 litre**



6. AUTOMATIC GEARBOX OIL

XK8 4.2 from VIN...A30645 to A48684
1 litre bottle Part no. 485554

gearbox capacity: **10 litre**



7. CASTROL OIL

Transmax Dex III for power steering - replaces TQ Dexron III

XK8 4.0 to VIN...A30644, XK8 4.2 from VIN...A30645 to B32752, XK8 3.5 to VIN...B32752, XK8 5.0 from VIN...B32753

Transmax Dex III is a high quality mineral based automatic transmission fluid, recommended for most passenger cars where a product to GM Dexron III, Ford Mercon 94 or Allison C4 is recommended.

1 litre bottle Part no. 217068

power steering capacity: **1 litre**



8. JAGUAR ANTI-FREEZE COOLANT

radiator

XK8 4.0 to VIN...042634

1 litre bottle Part no. 422089
5 litre canister Part no. 422090

cooling system capacity: **10 litre**



9. JAGUAR ANTI-FREEZE COOLANT

radiator

XK8 4.0 from VIN...042635 to A30644, XK8 4.2 from VIN...A30645 to B32752, XK8 3.5 from VIN...B00379 to B32752, XK8 5.0 from VIN...B32753

1 litre bottle Part no. 422635
5 litre canister Part no. 22636

cooling system capacity: **10 litre**



10. WAGNER ADDITIVE

Bactofin - fuel stabilizer, special for fuels with Bio-Ethanol (E10). Dosage: 1:1000

100 ml bottle Part no. 494084
300 ml bottle Part no. 494085
1 litre bottle Part no. 494086

Modern fuels attack the metal parts of the fuel supply systems. This problem applies especially to older vehicles, while in modern cars, for good reasons, more and more plastic tanks are used. The second problem relates to biogenic fuels and mixed fuels. This problem applies to owners of all ages of cars and modern cars too. In modern fuels bacteria grow in unprecedented quantities. This produces a lot of dirt, especially when the vehicle is not in regular use. The pipes gradually get blocked and the tank becomes contaminated with dirt. Rather than the drastic measure of replacing the entire fuel supply system, regular use of Bactofin will reduce the problem considerably. For vehicles which normally operate with lead-replacement or top oil, using Bactofin is just as easy and will give owners peace of mind. Bactofin also prevents any corrosion of the fuel system. Rust is completely inhibited!



6. OILS, LUBRICANTS, FLUIDS AND ADDITIVES

11. CASTROL GEAR OIL

SAE 75W/140

XK8 4.0 to VIN...A30644,
XK8 4.2 from VIN...A30645 to B32752,
XK8 3.5 from VIN...B00379 to B32752,
XK8 5.0 except Supercharged from VIN...B32753
 1 litre bottle Part no. 472147

Castrol Syntrox Limited Slip 75W/140 (Formerly SAF-XJ 75W/140) is a fully synthetic SAE 75W/140 hypoid gear oil formulated for use in both conventional and limited slip differentials.

Whilst being suitable for all applications where a lubricant of this quality is specified it is specially formulated for use in limited slip differentials fitted to Japanese vehicles requiring an SAE 75W/140 Extreme Pressure Gear Oil. Castrol Syntrox Limited Slip 75W/140 has additionally demonstrated outstanding performance in competition vehicles employing limited slip differentials.

Castrol Syntrox Limited Slip 75W/140 is also specifically designed for BMW differentials including the Z3 limited slip differential.

Benefits of Castrol Syntrox Limited Slip 75W/140:

- Excellent shear stability
- Exceptional resistance to oxidation
- Particularly effective resistance to very strong loads
- Very good low temperature fluidity properties
- Affords increased drain intervals

Specifications and Manufacturer Approvals

- API GL-5
- ZF TE-ML-05D, 12D, 16G
- US claims - MIL-L-2105D
- BMW Approved (for limited slip)



12. HYDRAULIC OIL

Denso ND8 - for air conditioning compressor

XK8 4.0 from VIN...A30644,
XK8 4.2 from VIN...A30645 to B32752,
XK8 3.5 from VIN...B00379 to B32752,
XK8 5.0 from VIN...B32753
 250 ml tin Part no. 277493



13. CASTROL BRAKE FLUID

React Performance DOT 4

XK8 4.0 to VIN...A30644,
XK8 4.2 from VIN...A30645 to B32752,
XK8 3.5 to VIN...B32752,
XK8 5.0 from VIN...B32753
 1 litre bottle Part no. 472095

Castrol React Performance DOT 4 is a high boiling point polyglycol type brake fluid designed to provide superior braking performance in a variety of vehicles, especially those that operate at higher temperatures or under increased loads. The product has been formulated to give outstanding system protection against corrosion and high temperature vapour lock.

Castrol React Performance DOT 4 is suitable for use in all brake fluid systems in cars, motorcycles and light commercial vehicles requiring either a DOT 3, DOT 4 or Super DOT 4 product (excluding where a mineral oil based fluid is specified). Castrol React Performance DOT 4 can be used with either disc or drum brakes, including modern vehicles fitted with ABS systems. The product is also suitable for use in hydraulic clutch systems.

Product features and benefits:

1. High boiling point - exceeds US FMVSS DOT 3 and DOT 4 specification requirements, and offers a performance reserve over brake fluids with lower boiling points.
2. High vapour lock temperature - greater protection against brake fluid vaporization.
3. Corrosion protection – outstanding protection against corrosion caused by absorbed moisture, that can contribute to lower maintenance costs.
4. High temperature stability provides a greater margin for safety because product performance will not fade under higher temperatures.
5. Controlled viscosity requirements - under extremes of temperature and operating conditions, Castrol Response Super DOT 4 will maintain an optimum operating viscosity to ensure greater safety.
6. Rubber swell control - contributes to efficient operation of the braking system components.
7. Compatible with all other brake fluids that meet either DOT 3, DOT 4 or Super DOT 4 specification.



14. SCREEN WASH

with anti-freeze up to -70°C

1 litre bottle Part no. 394782
 5 litre canister Part no. 394781

With citrus fragrance. Keeps the windscreen clean and ice-free and keeps the windscreen washer.



15. CW 1:100 ® SCREEN TREATMENT

removes blinding, oily films with greatest economy - 1:200 concentrate with dosage head

250 ml bottle Part no. 492763

The economy of CW 1:100 Classic is unbeatable. One 250 ml bottle can be diluted to a ratio of 1:200, thus produces 50 litres of highly effective cleaning liquid. Removes blinding, oily films from the windscreen, and is the best product for the quality-conscious, economical driver. Special action: Increases the life of windscreen wipers. Can be mixed with any commercial antifreeze. Is also suitable for plastic headlight lenses and fan nozzles.



6. OILS, LUBRICANTS, FLUIDS AND ADDITIVES

16. HYDRAULIC OIL

especially designed for the convertible top hydraulics

- XK8 4.0 Convertible to VIN...A30644,**
- XK8 4.2 Convertible from VIN...A30645 to B32752,**
- XK8 3.5 Convertible from VIN...Boo379 to B32752,**
- XK8 5.0 Convertible from VIN...B32753**

1 litre tin Part no. 422783

Pentosin CHF 11S is a synthetic high performance hydraulic fluid for life-time application in modern vehicle aggregates. It is suitable for all extreme conditions and guarantees full performance from -40°C to 130°C system temperature. Pentosin CHF 11S is especially designed for hydraulics in the automotive industry with highest technical requirements. Due to its excellent features it is used in following devices (extract): power steering, level control, shock absorber, hydro-pneumatic suspension, stability- and traction control, hydraulics for convertible tops, central lock systems.



16.

17. K&N AIR FILTER CLEANER

330 ml pump bottle Part no. 4820

18. K&N AIR FILTER CLEANER

1 litre bottle Part no. 319259

The only cleaner formulated to clean K&N filtercharger elements. The use of other cleaning liquids can result in damaging the cotton material of the air filter and therefore the guarantee expires. K&N air filter cleaners are diminishable biologically and do not harm alloy, chrome, rubber, plastic and lacquer to. K&N filters can be washed out up to 25 times before they need to be replaced.



17.



18.

19. K&N AIR FILTER OIL

enough for 2 filters

20 ml pouch Part no. 214887



19.

20. K&N AIR FILTER OIL

237 ml bottle Part no. 12353

21. K&N AIR FILTER OIL

355 ml bottle Part no. 311572

K&N air filter oil is the only oil specially formulated to work in combination with the cotton fabric in K&N filtercharger elements providing a superior air filtration system. When used as directed, it quickly penetrates the filter pleats, where it remains suspended in the cotton fabric. Saturation is maintained until the element is cleaned with K&N air filter cleaner.



20.



21.

22. WRINGER

for chamois and towels. Heavy duty steel construction, nearly indestructible. Removes 90% of the water. Cylinder width: 30 cm

Part no. 290337



22.

23. CHAMOIS

Finest chamois leather, 100% oil tanned

2.5 sqf. Part no. 292546

4 sqf. Part no. 292581



23.

Note the use of brand names:

The inclusion of trade names in the index is purely for ease of looking up. The article described may not have been made by the owner of the trademark. All rights to brand names or trademarks belong to their rightful owners.

A

ABS Sensor 12.5, 12.6
Accelerator and brake pedal extension 12.6, 20.1
Accelerator cable 5.1
Actuator headlamp levelling 14.5
Adaptor for pulley locking wrench 217104 21.2
Adaptor for socket 493698 21.3
Additive Bactofin (fuel stabilizer) 7.1, 21.6
Advance board 15.1
Aerial mast 18.3
Air conditioning 14.4
Air conditioning compressor 14.4
Air filter cleaner 21.6
Air filter element 6.1
Air filter oil 21.6
Air inlet temperature sensor 5.1
Air inlet thermal transmitter 5.1
Air inlet vacuum sensor 5.1
Air intake grille bonnet 17.1
Air-flow meter 6.1
Alternator 14.1
Alternator drive belt 1.1, 14.1
Aluminium Devil wheel cleaner 13.1
Anti roll bar link, front suspension 8.1, 8.2
Anti roll bar link, rear suspension 11.1, 11.2
Anti-freeze coolant for radiator 4.1, 4.2, 21.6
Automatic gearbox oil 2.1, 21.6

B

Bactofin (fuel stabilizer) 7.1, 21.6
Badge on bonnet 18.1
Badge on boot lid 18.1
Badge on front wing 18.1
Badge on hub cap 13.1
Badge on radiator grille 18.2
Ball bearing differential 11.3
Bleeding hose 21.2
Ball joint separator 21.2
Ball joint wishbone, front suspension 8.1
Ballpoint pen 21.4
Baseball cap 21.4
Battery charger 21.1
Battery for infrared thermometer 306497 21.3
Battery-Booster 21.1
Bearing shim, rear suspension 11.1
Bellu, Serge 21.5
Big bore exhaust system 9.1
Blanking plug oil drain, engine 1.1
Bleed screw, brake caliper 12.1, 12.3
Blundsen, John 21.5
Body contour gauge 15.1
Body shell 15.1
Bonnet 15.1
Books 21.5
Boot lid 15.1
Boot liner 20.1
Boot mat 20.1
Boot release switch 14.7
Bottle opener 21.4
Bracket front bumper 16.1
Bracket rear bumper 16.1
Brake and accelerator pedal extension 12.6, 20.1

Brake caliper, front brakes 12.1
Brake caliper, rear brakes 12.3
Brake cleaner 12.4
Brake disc, front brakes 12.1, 12.2
Brake disc, rear brakes 12.3, 12.4
Brake fluid 12.5, 12.6, 21.6
Brake hose 12.1, 12.3
Brake hoses, stainless steel braided 12.1, 12.3, 21.1
Brake master cylinder 12.5
Brake pads, front brakes 12.1, 12.2, 21.1
Brake pads, rear brakes 12.3, 12.4, 21.1
Brake shoes handbrake 12.5
Buffer windscreen 19.1
Bulbs 14.5, 14.7
Bump stop rubber, rear suspension 11.1
Bumper armature, front bumper 16.1
Bumper armature, rear bumper 16.1
Bumper, front 16.1
Bumper, rear 16.1
Bush front shock absorber 8.1, 8.2
Bush kit brake caliper pin, front brakes 12.1
Bush kit brake caliper, front brakes 12.2
Bush kit brake caliper, rear brakes 12.3, 12.4
Bush kit, front suspension 21.1
Bush pendulum mounting, rear suspension 11.1
Bush pendulum strut, rear suspension 11.1
Bush shock absorber, rear suspension 11.1, 11.2
Bush steering rack mounting 10.1, 10.2
Bush subframe to chassis, front suspension 8.1
Bush subframe to chassis, rear suspension 11.1
Bush wishbone, front suspension 8.1, 8.2

C

C Tek Battery charger 21.1
Camshaft cover gasket 1.2
Camshaft sensor 5.1
Camshaft setting and locking tool 21.2
Cap 21.4
Cap for wheel lock nuts 13.1
Car cover 21.4
Carpets 20.1
Catalog, Old love never dies 20.1
Castrol Brake fluid 12.5, 12.6, 21.6
Castrol Edge Full synthetic engine oil 1.1, 21.6
Castrol Gear oil 11.2, 11.3, 21.6
Castrol Magnatec Full synthetic engine oil 1.1, 21.6
Castrol Power steering oil 14.7
CD autocharger magazine 14.7
Centre silencer 9.1
Ceramic brake pads 21.1
Chamois 21.6
Check module for bulbs in rear lamps 14.5
Check strap, door 18.3
Chemico Valve grinding paste 21.3
Cigar lighter element 14.7
Circlip differential bearing 11.3
Circlip wheel bearing, front suspension 8.1
Circlip wheel bearing, rear suspension 11.2
Clarke, R.M. 21.5
Coffee mug 21.4
Coil spring front suspension 8.1, 8.2, 21.1
Coil spring insulator, front suspension 8.2
Coil spring insulator, rear suspension 11.2
Coil spring rear suspension 11.1, 21.1
Colour sample for car cover 21.4
Combination spanner set 21.3
Compartment air filter 14.4
Competition coil springs 21.1
Computer mouse 21.4

Concorso wax 21.4
Condenser air conditioning 14.4
Cone for selector lever 284587 20.1
Connecting harness shock absorber, rear suspension 11.1
Connector handbrake cable 12.5
Connector oil drain valve 21.1
Connector windscreen and rear screen 19.1
Connolly Leather care kit 20.1
Control valve for variable valve timing 5.1
Conversion gasket set 1.1
Conversion kit for engine drive belt 1.1
Conversion kit for supercharger drive belt 1.1
Coolant temperature sensor 5.1
Copper paste 12.1 to 12.4
Corkscrew 21.4
Cover door mirror 19.2
Cover powerwash jet on headlamp 14.5
Crankshaft locking tool 21.2
Crankshaft sensor 5.1
CW 1:100 ® Screen treatment 19.1, 21.6
Cylinder head bolt 1.2
Cylinder head gasket 1.2
Cylinder head gasket set 1.2

D

D1S Xenon burner 14.5
Denso air conditioning compressor 14.4
Differential oil 11.2, 11.3, 21.6
Digital infrared thermometer 21.3
Dolly 11.3
Door 15.1
Door check strap 18.3
Door mirror cover 19.2
Door skin 15.1
Drain plug automatic transmission 2.1
Drive belt for alternator 1.1, 14.1
Drive belt for engine 1.1, 14.1
Drive belt for supercharger 1.1
Dust cap brake caliper bleed screw, front brakes 12.1
Dust cap brake caliper bleed screw, rear brakes 12.3
Dust cover brake disc, front brakes 12.1
Dust cover brake disc, rear brakes 12.3
Dust seal shock absorber, front suspension 8.1, 8.2
Dust seal shock absorber, rear suspension 11.2
Duster 21.4

E

EBC Brake pads 21.1
EGR valve hose 14.3
Element for cigar lighter 14.7
Engine drive belt 1.1, 14.1
Engine drive belt conversion kit 1.1
Engine mounting 1.1
Engine oil 1.1, 21.6
Evaporator air conditioning 14.4
Exhaust 9.1
Exhaust bracket 9.1
Exhaust clamp 9.1
Exhaust gasket 9.1
Exhaust mounting rubber 9.1, 9.2
Exhaust system made from stainless steel 9.1
Expansion tank filler cap 4.1
Extension for accelerator and brake pedal 12.6, 20.1

F

Filler cap for brake master cylinder 12.5, 12.6
Filler cap for expansion tank 4.1

- Filler cap for power steering reservoir10.2
 Filler cap for windscreen washer bottle14.6
 Filler neck for washer bottle14.6
 Filter inside fuel pump7.1
 FilterMAG21.1
 Fire extinguisher spray21.4
 Fitting kit brake pads, front brakes12.1
 Fitting kit brake pads, rear brakes12.3
 Fitting kit front bumper16.1
 Flange differential pinion11.3
 Flexible coupling propshaft11.3
 Fluid level sensor for cooling system expansion tank4.1
 Fog lamp14.5
 Footwell carpets20.1
 Footwell rubber mats20.1
 Front screen19.1
 Front silencer9.1
 Front wing15.1
 Fuel filler cap7.1
 Fuel filter7.1
 Fuel injector6.1
 Fuel pressure regulator6.1
 Fuel pressure sensor6.1
 Fuel pump7.1
 Fuel pump filter7.1
 Fuel sender unit7.1
 Fuel stabilizer Bactofin7.1, 21.6
 Fulcrum pin hub carrier to trailing arm, rear suspension11.1
 Fulcrum pin trailing arm to pendulum, rear suspension11.1
 Full synthetic engine oil, Castrol Edge1.1, 21.6
 Full synthetic engine oil, Castrol Magnatec1.1, 21.6
 Fuse14.7
- G**
- Gas strut bonnet18.3
 Gas strut boot lid18.3
 Gasket camshaft cover1.2
 Gasket catalytic converter to exhaust manifold9.1
 Gasket exhaust manifold1.2, 9.1
 Gasket inlet manifold6.1
 Gasket intercooler tray to cylinder head6.1
 Gasket set gearbox2.1
 Gasket water pump4.1
 Gauge for simple wheel alignment21.3
 Gear knob20.1
 Gear oil11.2, 11.3, 21.6
 Gear wrench set21.3
 Gearbox gasket set2.1
 Gearbox mounting rubber2.1
 Gearbox oil2.1, 21.6
 Glass bonding adhesive19.1
 Glass, door mirror19.2
 Grease21.3
 Grease for bushes8.1, 11.1, 11.2
 Grease gun21.3
 Grille panel, radiator grille17.1
 Guide for primary timing chain1.1
 Guidetti, Marco21.5
 Gunson's Gauge for simple wheel alignment21.3
 Gunson's Lambda sensor tester5.1
- H**
- H1 Halogen bulb14.5
 Halogen bulb14.5
 Hammer15.1
 Hand tap21.3
 Handbrake cable12.5, 12.6
 Handbrake mechanism rebuilt kit12.5
 Handbrake warning light switch12.5
 Harness shock absorber, rear suspension11.1
 HB3 Halogen bulb14.5
 Headlamp14.5
 Headlamp lens14.5
 Heater hose14.3
 Heater matrix14.3
 Heater pipe14.3
 Heater valve14.3
 Holder for cup in console lid20.1
 Hose4.2
 Hose clips for heater hoses14.3
 Hose clips for steering rack gaiters10.1, 10.2
 Hose for supercharger4.2
 Hub carrier, front suspension8.1
 Hub, front suspension8.2
 Hub, rear suspension11.2
 Hydraulic dolly11.3
 Hydraulic oil for air conditioning compressor14.4, 21.6
 Hydraulic oil for ride level control, shock absorber hydro pneumatic suspension, power steering, convertible top hydraulics20.1
 Hydraulic pipes for power steering rack10.1
 Hydraulic reservoir for power steering10.1
- I**
- Idler pulley for engine drive belt1.1
 Idler pulley for supercharger drive belt1.1
 Ignition coil14.2
 Ignition module14.2
 Impact wrench21.3
 Insulator on coil spring, front suspension8.2
 Insulator on coil spring, rear suspension11.2
 Intercooler tray gasket6.1
 Interior mirror19.2
 Isolator buffer coil spring, rear suspension11.1
 Isolator buffer shock absorber, front suspension8.1
- J**
- Jaguar Air conditioning compressor14.4
 Jaguar Anti-freeze coolant for radiator4.1, 4.2, 21.6
 Jaguar Ballpoint pen21.4
 Jaguar books21.5
 Jaguar Brake caliper, front brakes12.1
 Jaguar Brake caliper, rear brakes12.3
 Jaguar Brake discs, front brakes12.1, 12.2
 Jaguar Brake discs, rear brakes12.3, 12.4
 Jaguar Brake pads, front brakes12.1, 12.2
 Jaguar Brake pads, rear brakes12.3, 12.4
 Jaguar Car cover21.4
 Jaguar Fuel filter7.1
 Jaguar Fuel pump7.1
 Jaguar Gear knob20.1
 Jaguar Ignition coil14.2
 Jaguar Key fob21.4
 Jaguar Oil filter1.1
 Jaguar Teddy Bear21.4
 Jaguar Umbrella21.4
 Jet for headlamp powerwash14.5
 Jet for windscreen washer14.5
- K**
- K&N Air filter21.1
 K&N Air filter cleaner21.6
 K&N Air filter oil21.6
 Kevlar brake pads21.1
 Key fob21.4
- Key ring21.4
 Key, blank, with Jaguar head18.3
 Knock sensor5.1
- L**
- Lambda oxygen sensor5.1, 9.1, 9.2
 Lambda sensor chaser5.1, 21.3
 Lambda sensor tester21.3
 Lamp repeater on front wing14.5
 Lamp, front14.5
 Lamp, rear14.5
 Leather care kit20.1
 Lens number plate lamp14.5
 Letter opener21.4
 Limora Valve grinder21.3
 Location tube hub carrier fulcrum pin, rear suspension11.1
 Luster Lace Polishing strips18.1, 18.2, 21.4
 LZR 2 Grease21.3
- M**
- Magazine for original Jaguar CD autocharger20.1
 Magnet holder21.3
 Manifold gasket intercooler tray to cylinder head6.1
 Manifold gasket, exhaust manifold1.2, 9.1
 Manifold gasket, inlet manifold6.1
 Master Collection (Swizöl)21.4
 Mirage wax21.4
 Mirror glass, door mirror19.2
 Moulding on front bumper16.1
 Mounting rubber gearbox2.1
 Mounting subframe to chassis, front suspension8.1
 Mouse21.4
 Multimeter21.3
- N**
- Nameplate on boot lid18.1
 Nameplate on front wing18.2
 Net pocket for boot area21.4
 NGK Spark plug1.1, 14.2
 Number plate lamp lens14.5
 Nut splitter21.3
- O**
- Oil drain pan21.1
 Oil drain plug for automatic transmission2.1
 Oil drain plug, engine1.1
 Oil drain valve21.1
 Oil drip mat21.4
 Oil filter1.1
 Oil filter magnet21.1
 Oil filter wrench21.3
 Oil pressure switch5.1
 Oil seal on differential pinion11.3
 Oil seal on oil pump, automatic transmission2.1
 Oil seal on output shaft, automatic transmission2.1
 Oil seal on selector shaft, automatic transmission2.1
 Oil strainer automatic transmission2.1
 Oil sump gasket, automatic transmission2.1
 Oil sump gasket, engine1.1
 Oil temperature sensor5.1
 Old love never dies catalogue21.1
 On plug ignition coil14.2
 Onyx wax21.4
 Oxygen sensor5.1, 9.1, 9.2

P

Pad for tensioner on primary timing chain 1.1
 Panel beater sand bag 15.1
 Paperweight 21.4
 Parking sign 21.4
 Passenger compartment air filter 14.4
 Pedal rubber for brake pedal 12.5, 12.6
 Pen 21.4
 Pfanmueller, Matthias 21.5
 Piston brake caliper, front brakes 12.1
 Piston brake caliper, rear brakes 12.3
 Pliers 14.3, 21.2
 Pocket wrench 21.3
 Polishing strips 18.1, 18.2, 21.4
 Polyurethane bush kit, front suspension 8.1
 Power steering oil 10.1, 10.2, 21.6
 Power steering unit 10.1
 Powerwash jet cover 14.5
 Pressure failure switch at brake
 master cylinder 12.5
 Pressure switch air conditioning 14.4
 Primary timing chain guide 1.1
 Propshaft coupling 11.3
 Prymos® Fire extinguisher spray 21.4
 Puller for ABS timing rotor 12.5, 21.2
 Puller for crankshaft pulley 21.2
 Puller for rear hub 21.2
 Pulley for engine drive belt 1.1
 Pulley for supercharger drive belt 1.1
 Pulley locking tool 21.2

R

Radiator 4.1
 Radiator cap 4.1
 Radiator coolant 4.1, 4.2, 21.6
 Radiator grille panel 17.1
 Radiator hose 4.1
 Rear lamp 14.5
 Rear side panel 15.1
 Rear silencer 9.1, 9.2
 Rear wing 15.1
 Rebuild kit handbrake mechanism 12.5
 Receiver drier air condition 14.4
 Reflector on front and rear bumper 14.5
 Relay 14.2, 14.7
 Remote key fob 18.3, 21.1
 Remove for front hub 21.2
 Repeater lamp on front wing 14.5
 Robson, Graham 21.5
 Rubber buffer windscreen 19.1
 Rubber bush anti roll bar,
 front suspension 8.1, 8.2
 Rubber bush anti roll bar,
 rear suspension 11.1, 11.2
 Rubber mats footwell 20.1
 Rubber seal inlet manifold to
 induction elbow 6.1
 Rubber sealing ring spark plug 1.2
 Rubber strip for wiper blade 14.6

S

Schrader, Halwart 21.5
 Screen treatment 19.1, 21.6
 Screen wash with anti-freeze 21.6
 Screwdriver 21.3
 Seal between air-flow meter and air pipe 6.1
 Seal inlet manifold to induction elbow 6.1
 Seal kit brake caliper, front brakes 12.1
 Seal kit brake caliper, rear brakes 12.3
 Sealing compound for auto body work 15.1
 Sealing ring evaporative loss flange to tank 7.1
 Sealing ring fuel injector to adaptor 6.1
 Sealing ring spark plug 1.2

Sealing rubber fuel sender unit 7.1
 Sealing rubber headlamp
 powerwash pump 14.6
 Sealing rubber screenwash pump 14.6
 Seat cover 21.4
 Sensor air inlet vacuum 5.1
 Sensor fuel pressure 6.1
 Sensor to detect camshaft position 5.1
 Sensor to detect engine speed
 and crankshaft position 5.1
 Sensor wheel speed (ABS) 12.5, 12.6
 Shim tapered roller bearing,
 rear suspension 11.1
 Shock absorber, front suspension 8.1, 8.2
 Shock absorber, rear suspension 11.1, 11.2
 Shrinking hammer 15.1
 Side panel, rear 15.1
 Silencer 9.1, 9.2
 Sill threshold plate 20.1
 Socket for the removal of ball joints 21.3
 Socket set 21.3
 Spacing washer coil spring,
 rear suspension 11.1
 Spanner set 21.3
 Spanner to remove wheel
 lock nut caps 13.1
 Spark plug 1.1, 14.2
 Special grease for bushes 8.1, 11.1, 11.2
 Special socket for lambda
 oxygen sensors 5.1
 Special spanner to remove wheel
 lock nut caps 13.1
 Special tools 21.2
 Spoke brush 13.1
 Spring and damper mounting,
 front suspension 8.1
 Spring and damper mounting,
 rear suspension 11.1
 Spring clip front brake pads 12.1
 Spring clip rear brake pads 12.3
 Spring collar front coil spring 8.1
 Spring collar rear coil spring 11.1
 Stainless steel exhaust system 9.1
 Starter motor 14.1
 Steering column 10.1
 Steering pump 10.1, 10.2
 Steering rack gaiters 10.1, 10.2
 Steering rod, rear suspension 11.2
 Stertkamp, Heiner 21.5
 Stoneguard for fog lamps 14.5
 Stool 21.4
 Strut, pendulum to differential,
 rear suspension 11.1
 Stub axle, front suspension 8.2
 Suction pad 15.1
 Supercharger drive belt conversion kit 1.1
 Supercharger hose 4.2
 Supercharger radiator 4.2
 Switch boot release 14.7
 Switch handbrake warning light 12.5
 Swizöl 21.4

T

Tachometer, digital gauge with
 laser RPM pick up 21.3
 Tail pipe finisher 9.1
 Tapered roller bearing differential carrier 11.3
 Tapered roller bearing shim,
 rear suspension 11.1
 Tapered roller bearing, rear suspension 11.1
 Teddy Bear 21.4
 Temperature sensor air inlet 5.1
 Temperature sensor coolant 5.1
 Temperature sensor oil 5.1
 Tension pulley for engine drive belt 1.1

Tension pulley for supercharger drive belt 1.1
 Thermal transmitter air inlet 5.1
 Thermostat 1.2, 4.1, 21.1
 Thermostat housing 1.2, 4.1, 21.1
 Thorley, Nigel 21.5
 Threshold plate on sill 20.1
 Throttle body 6.1
 Throttle body hose 14.3
 Timing chain camshaft (secondary chain) 1.2
 Timing chain crankshaft (primary chain) 1.1
 Timing chain kit 1.1
 Timing chain tensioner for
 primary timing chain 1.1
 Timing chain tensioner for
 secondary timing chain 1.2
 Timing chain tensioner pad 1.1
 Timing chain tensioner tool 21.2
 Timing rotor ABS sensor, front brakes 8.1, 12.5
 Timing rotor ABS sensor, rear sensor 11.1, 12.5
 Tool kit for the removal of bonded screens 19.1
 Tool roll 21.3
 Tools 21.2, 21.3
 Torque wrench 21.3
 Track rod end 10.1, 10.2
 Transducer for 12.5
 Tuga Chemie Wheel cleaner 13.1
 Tyre valve caps 13.1, 21.4

U

Umbrella 21.4
 Underrider 16.1
 Union Jack stool 21.4
 Universal joint on steering column 10.2
 USB memory stick 21.4

V

Valve grinder 21.3
 Valve grinding paste 21.3
 Variable valve timing tool 21.2
 Viart, Bernard 21.5

W

Wagner Additive Bactofin
 (fuel stabilizer) 7.1, 21.6
 Washer bottle windscreen wiper
 and headlamp powerwash 14.6
 Washer pump headlamp powerwash 14.6
 Washer pump windscreen 14.6
 Water pump 4.1
 Water pump for air conditioning 14.3, 14.4
 Water pump for supercharger 4.2
 Wax 21.4
 Wedge for timing chains 21.2
 Wheel 13.1
 Wheel alignment gauge 21.3
 Wheel arch set 21.1
 Wheel bearing, front suspension 8.1
 Wheel bearing, rear suspension 11.1, 11.2
 Wheel cleaner 13.1
 Wheel lock nuts 13.1
 Wheel nut 13.1
 Wheel speed (ABS) Sensor 12.5, 12.6
 Wheel stud, front suspension 8.1, 13.1
 Wheel stud, rear suspension 11.1, 11.2, 13.1
 Wind deflector 21.1
 Windscreen 19.1
 Windscreen wash with anti-freeze 21.6
 Wing cover 21.4
 Wing, front 15.1
 Wing, rear 15.1
 Wiper blade 14.6
 Wiper motor 14.6

Wire wheel	13.1
Wishbone, front suspension	8.1, 8.2
Wishbone, rear suspension	11.2
Wringer for chamois and towels	21.6

X

Xenon burner	14.5
Xenon headlamp	14.5

- Accessories
- Tools
- Oils and lubricants
- Internal and external fixtures
- Books and manuals
- Tuning
- Seat belts

Old Love
never dies

Old love never dies

German Part no. 492147

English Part no. 15119

French Part no. 491321



Order catalogue:



Order a free copy:

www.Limora.com

