

LIMORA

Top 1200

PARTS AND ACCESSORIES FOR

Jaguar X308

XJ8 and XJR (1997 - 2003)



Jaguar X308 - The Evolution success

The Jaguar X308 is the result of a long development: The car started as the X300 and it was 11 years before it received a facelift as part of the newly developed eight-cylinder Jaguar. The perceived style of the X300 was considered as not really fitting the Jaguar marque. The XJ40 took over, based substantially on the existing technology and the familiar 6 - and 12 - cylinder engines. The X300 adopted the design innovations of the XJ40, losing the angular shape and the square headlight in favour of a return to a smoother and more classic style. This X300 with the classic lines of the luxury saloon restored their original clientele. Since February 1995 there were minor changes to the body styling but in the spring of 1997 the X308 with major design changes became the successor to the X300. Effectively an X300 with a V8 engine. The eight-cylinder engine was unusual for Jaguar and is worth closer examination: After the takeover by Ford in 1990, it was realised quickly that the Jaguar engine pool had to be replaced urgently. The elderly inline six-cylinder and the V12 cylinder engines were very expensive to manufacture, complicated to maintain, and were struggling to meet the increasing demands of environmental compatibility. The Ford view was that the newly developed Ford Modular V8 engine could be simply tucked under the Jaguar hood. Jaguar engineers were opposed to this and convinced Dearborn that Jaguar clients would not accept a U.S. power unit. The result was the development of the Jaguar Compact V8 engine, which was accepted worldwide by customers due to its outstanding characteristics. The AJ26 product with its 4-litre capacity is an up-to-date product: plastic intake manifold, four camshafts and 32 valves resulting in a weight of only 200 kg to provide more than 300hp. All this without the usual but inappropriate eight cylinder bubble. The AJ-V8 engine is accepted since the mid-90s as the backbone of the Jaguar engine pool. The engine was built by Jaguar, presented in the XK8 in 1996, then renovated in the X300, returning for the X308. In the Ford range, the engines were still adapted from the Aston Martin, Land Rover and Lincoln. From February 1997, the first prototypes of the X308 were spotted on the road. On September 11, 1997, the X308 was presented to the public at the IAA in Frankfurt. The vehicle was available with a 3.2 litre, 4.0 litre or 4.0 litre supercharged and with 276 kW. Manual transmission was not available, and the system came as the ZF in most cases. The X308 was launched with a completely new interior design, a modified instrument panel and new upholstery. The last design traces of the XJ40 were replaced. There were two essentially different model lines, one based on comfort line with XJ8, Sovereign and Daimler, and Vanden Plas. The other line addressed the sport style and XJR models. Even the entry model XJ8 had leather interior and expansive wooden interior trim. Top of the range were the Sovereign and Daimler models. All vehicles were available in two wheelbases. The XJ8 sport models differed primarily by matte black trim, but the XJR - the second model of the sporty line was designed to attack the BMW market: 18" wheels accommodated huge Brembo brakes and the above mentioned supercharged 4.0 ltr. compressor motor gave a competitive acceleration of less than 5 seconds to 62 mph. This all went eye to eye with the then current BMW M5. The last manufacture was in 2002, commemorating the 100th Birthday of Sir William Lyons. 500 copies of the XJR 100 had a level of equipment and power which was the peak of the series: 19 "inch wheels from BBS, further enlarged Brembo brakes and a sporty two-tone interior styling. But time was running out for the X308. From the beginning of 2003 the successor was ready in the newly designed and technically advanced X350 with an aluminum body. A total of 126.260 units of the X308 were made to December 2002. The last were sold in 2003.

Your Team Limora

Limora Hauptsitz

Industriepark Nord 19-21
D - 53567 Buchholz
Telefon: +49 (0) 26 83 - 97 99 0
Fax: +49 (0) 26 83 - 70 59
E-Mail: Limora@Limora.com

Limora Aachen

Oldtimer-Warenhaus
Feldstraße 41
D - 52070 Aachen
Tel: +49 (0) 241 - 55 939 0
Fax: +49 (0) 241 - 55 939 20
E-Mail: Aachen@Limora.com

Nous parlons français Wij spreken nederlands

Limora Berlin

Classic Remise
Wiebestraße 36-37
D - 10553 Berlin
Tel: +49 (0) 30 - 25 93 92 30
Fax: +49 (0) 30 - 25 93 92 33
E-Mail: Berlin@Limora.com

Limora Düsseldorf

Classic Remise
Harffstraße 110a
D - 40591 Düsseldorf
Tel: +49 (0) 211 - 77 92 930
Fax: +49 (0) 211 - 98 471 08
E-Mail: Duesseldorf@Limora.com

Limora Stuttgart

Graf-Zeppelin-Platz 1
D - 71034 Böblingen
Tel: +49 (0) 70 31 - 306 95 10
Fax: +49 (0) 70 31 - 306 95 12
E-Mail: Stuttgart@Limora.com

Limora Hamburg

Hauptstr.49 / Blankeneser Chaussee
D - 22869 Hamburg-Schenefeld
Tel: +49 (0) 40 - 8405 24 20
Fax: +49 (0) 40 - 8405 24 22 038
E-Mail: Hamburg@Limora.com

Limora Bielefeld

LENKWERK
Am Stadtholz 24-26
D - 33609 Bielefeld
Tel: +49 (0) 5 21 - 26 074 50
Fax: +49 (0) 5 21 - 26 074 524
E-Mail: Bielefeld@Limora.com

Limora Paris

Tel: +33 (0) 139 - 57 05 99
Fax: +33 (0) 139 - 57 06 99
E-Mail: Paris@Limora.com

Limora Polska

E-Mail: Polska@Limora.com
Tel: +48 (0) 12 63 128 07

Internet www.Limora.com

Online price list

This catalogue is also available on the internet, with a convenient online order function. Due to the very large number of parts described in this catalogue it was not possible to include a printed pricelist. Our prices can be viewed online and are updated frequently. Please use the internet for further information and for reference. We are happy to assist you, if you have questions: Just call, fax or send an email.



General certification (ABE)

Please note for all repair and conversion work on a motor vehicle, the statutory provisions relating to road safety and operating permits pertain. We offer in our catalogue, parts that are not approved for road transport and may only be installed in vehicles that are used on the racetrack. In addition, the tax and insurance-related treatment depends on a vehicle being in its original state. An article listed here does not necessarily have a general operating permit. Depending on the type of part the comparison to the original factory version is important. If in doubt please contact the competent licensing authority or any government-approved testing agencies like the German TUV or DEKRA).

© 2012 by LIMORA Oldtimer GmbH & Co. KG

The content of this catalogue comprising text and illustrations is the subject of copyright protection. Limora Oldtimer GmbH & Co. KG is the owner of all such copyrights. No part of this publication may be copied, reproduced, stored in any retrieval system, communicated or transmitted in any form or by any means, including Photocopying, Electronic, Mechanical or otherwise, without prior written permission from Limora Oldtimer GmbH & Co. KG.

The catalogue team

Project management: Steffen Schwarz
Catalogue team: Steffen Schwarz and Florian Hering
Research team: Steffen Schwarz and Hans Smid
Photographs: Dennis Buckow
Layout: Florian Hering
Proof reading: John Collins

Part numbers

German catalogue: 496829
English catalogue: 496830
French catalogue: 496831

January 2014

A rectangular box containing a black and white photograph of a smiling young child on the left and the Plan International logo on the right. The logo consists of a blue circle with a stylized figure inside, and the word 'Plan' in blue below it.

Limora supports
the sponsorship of children
„Plan International“
(www.plan-international.org)
Take part in it!

Dear Clients, Enthusiasts, Drivers of all makes!

With more than 20 leading catalogues, 7 stores all over Germany. As soon as you need spare parts, consumables, tools or accessories: Contact us first. Visit our shops in the in Buchholz, Berlin, Bielefeld, Duesseldorf, Hamburg and Stuttgart or visit our 600 square metre shop in Aachen.

We try hard to make your visit a real experience. Touch, feel and try most of the products we offer in our accessories catalogue „Old love never dies“. And in case any questions remain, please contact our competent staff. Books, magazines, manuals and cuppa or coffee: Be our guest.

Limora offers regular seminars on technical and historical topics, readings and excursions. Find out what we can do for you: Order your free catalogue for your British classic car today, and don't forget to ask for the free paperback „Old love never dies“, with lots of relevant information concerning your favourite hobby.

We would love to welcome you.

Your Team Limora

Order catalogue:



Our new catalogues!
Now available online
with order function!



Visit our Online Shop: www.Limora.com

290 pages

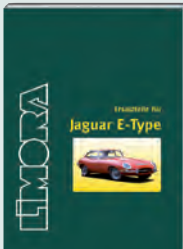

290 pages



64 pages



80 pages



740 pages



50 pages



1000 pages



600 pages



600 pages



690 pages



580 pages

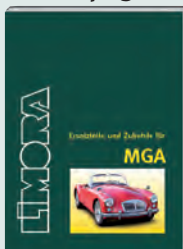

800 pages



64 pages



600 pages



324 pages

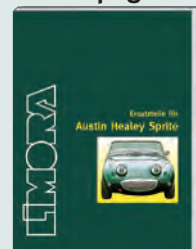

Introduction 1
 Copyright 2
 Content 4
 Changes during production 6
 Production figures 7
 Index 141



1. Engine

- 1.1 Cylinder block, oil sump and crankshaft 8
- 1.2 Cylinder head, camshaft and timing belt . . . 13



7. Fuel system

- 7.1 Fuel pump, fuel filter and sender unit. 27



2. Automatic transmission

- 2.1 Gaskets and oil seals 16



8. Front suspension

- 8.1 Shock absorber, wishbones and ball joints . . . 29



3. Clutch

Not applicable for this car



9. Manifold and exhaust system

- 9.1 Exhaust systems and gaskets 35



4. Cooling system

- 4.1 Radiator, thermostat and water pump 18
- 4.2 Supercharger cooling system 20



10. Steering

- 10.1 Track rod ends, steering rack, pump and gaiters 39

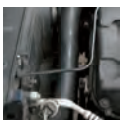

5. Engine controls

- 5.1 Accelerator cable and engine sensors 21



11. Rear suspension

- 11.1 Shock absorber, wishbones and coil springs 42
- 11.2 Differential 46

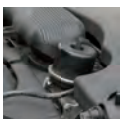

6. Fuel injection and air filter

- 6.1 Fuel injectors, manifold gaskets, throttle body and air filter 24



12. Brakes

- 12.1 Front brakes 48
- 12.2 Rear brakes 52
- 12.3 Hand brake, brake hydraulics and wheel speed sensors 55

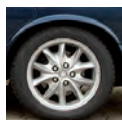

13. Road wheels

- 13.1 Road wheels and tyres.59

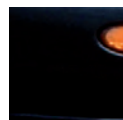

18. Body fittings and external trim parts

- 18.1 Badges and nameplates. 93
- 18.2 Body fittings 95



14. Electrics and heating

- 14.1 Starter motor and alternator.62
- 14.2 Ignition system.63
- 14.3 Heater unit and water hoses.64
- 14.4 Air conditioning68
- 14.5 Headlamps, side lamps and rear lamps71
- 14.6 Windscreen wiper, and wiper motor.75
- 14.7 Fuses, relays and switches78



19. Mirrors, glass and glazing

- 19.1 Glass and glazing 100
- 19.2 Door mirrors and interior mirror 102



15. Body panels

- 15.1 Wings, doors and bonnets81
- 15.2 Repair panels sill and engine bay83
- 15.3 Inner body repair panels, front section.84
- 15.4 Inner body repair panels, rear section85



20. Interior trim

- 20.1 Footwell carpets, gear knobs and threshold plates 104



16. Bumpers

- 16.1 Bumpers86

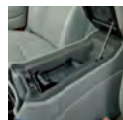

21. Competition parts and accessories

- 21.1 Competition parts. 110
- 21.2 Special car tools 116
- 21.3 Workshop tools 118
- 21.4 Accessories 123
- 21.5 Books 136
- 21.6 Oils, lubricants, fluids and additives 138



17. Radiator grille

- 17.1 Radiator grille and air intake grille.90

Components of the Vehicle Identification Number (VIN)

| | | | | | | | | | | | | |
|----------|---|---|---|---|---|---|---|---|---|----|----|--------|
| Position | 1 | 2 | 3 | 4 | 5 | 6 | 7 | 8 | 9 | 10 | 11 | 12 |
| VIN | S | A | J | J | P | X | L | L | 4 | X | F | 123456 |

Comment:

The vehicle serial number (the last 6 digits of the VIN) is required for ordering parts

| | | | | | | | | | | | |
|-----------------|--|--|--|--|--|--|--|--|--|--|--|
| Position 1 to 3 | Manufacturer code (SA) = Jaguar | | | | | | | | | | |
| Position 4 to 9 | Vehicle descriptor section | | | | | | | | | | |
| Position 10 | Vehicle model year | | | | | | | | | | |
| Position 11 | Model line and assembly plant | | | | | | | | | | |
| Position 12 | Vehicle serial number (last 6 digits) <input type="text"/> <input type="text"/> <input type="text"/> <input type="text"/> <input type="text"/> <input type="text"/> | | | | | | | | | | |

| YEAR | VIN NUMBER | ENGINE NUMBER | CHANGES |
|---------------|------------|---------------|--|
| November 1997 | 812317 | | Beginning of the X308 series production. A right hand drive XJ8 3.2 Executive |
| 1997 | 812323 | | Introduction of the supercharged XJR variant with 375 hp and automatic transmission from Mercedes-Benz, as well as standard adaptive damping system (CATS). This Suspension was for models without optional compressor |
| 1997 | 812325 | | First X308 with 4.0 V8 engine without supercharging, a link steered XJ8 4.0 Sovereign for the American market |
| 1997 | Unknown | | Introduction of the optional R Performance (Brembo) brakes for XJ8 and XJR Models with 355 mm brake discs for the front and 325 mm brake discs for the rear axle and 4-piston calipers front and rear |
| 1998 | 832728 | | Improved cooler is installed |
| 1998 | 853936 | | Start of the model year 1999 with the following changes: Front wheel now with reinforced bearings with 80 mm diameter, corresponding to changes in stabilizer arms, new steering, new crankshaft sensor, new camshaft sensors. Changes on models without compressor: New air flow meter, new fuel injectors, new knock sensors, new fuel pressure regulator, new intake manifold gasket, spark plugs with modified heat value. Larger front brake discs with 325 mm diameter for cars without R Performance (Brembo) brakes, and accordingly modified brake calipers |
| 1999 | 878717 | | Last vehicle in the 1999 model year |
| 1999 | F00035 | 9803250000 | Change in the vehicle identification number (VIN). The numbers at the end of the chassis number preceded by a letter that describes the model year. Start of Model year 2000 with the following changes: All engines come with a steel cylinder liners delivered. The previously installed liners with a Nikasil alloy are discontinued. Jaguar remedied many „early“ vehicles, for the problem with Nicasil coating for damage during the warranty. Tensioner and idler substitute for motor-ribbed belt from the previously built-up metal plastic version. New coolant type WSS M97B44-D, new gas cap, optional rain sensor optional available. Other changes affected the cam cover gaskets and the seal between the spark plug and cylinder head. Changes in models without compressor: Changed belt for motor drive, changes in 4.0 Compressor models: New upper oxygen sensors, air flow sensor, knock sensors, modified V-belt drive for compressor, spark plugs amended heat value, new throttle body |
| 1999 | F06183 | | New upper oxygen sensors for models without a compressor |
| 2000 | F20645 | | Start of the model year 2001 with the following changes: New gas cap rear, Parking sensor available as an option |
| | F39526 | | Improved front and rear brake calipers for cars with R-Performance (Brembo) brakes. Correspondingly changed wheel at the front-wheel suspension |
| 2001 | F40673 | | Changing the material composition of the front brake. This change only affected vehicles without R Performance (Brembo) brakes |
| August 2001 | F41862 | 0108122359 | Last model with plastic timing chain tensioners |
| August 2001 | F41863 | 0108130000 | Start of the model year 2002 with the following changes: The timing chain guide rails are now grey and the chain adjusters are now being made of cast aluminum and have a plastic running surface. Correspondingly changed timing chains. New temperature sensor for water temperature. Changed radiator hoses to the throttle body |
| | F59525 | | Last X308, a right-hand drive XJR. A total of 126,260 vehicles produced at Browns Lane. |

| MODELL | PRODUCTION |
|------------------------------|-------------------------------------|
| XJ8 3.2 | 20.235 (including Executive and SE) |
| XJ8 3.2 (LWB) | 771 |
| XJ8 3.2 Sovereign | 2.095 |
| XJ8 3.2 Sovereign (LWB) | 385 |
| XJ8 3.2 Sport | 1.108 |
| XJ8 4.0 | 8.369 |
| XJ8 4.0 (LWB) | 148 |
| XJ8 4.0 Sovereign | 36.635 (including SE) |
| XJ8 4.0 Sovereign (LWB) | 11.566 |
| XJR | 15.203 |
| XJR 100 | 500 |
| 4.0 Vanden Plas (SWB) | 1 |
| 4.0 Vanden Plas (LWB) | 21.080 |
| 4.0 Vanden Plas Supercharged | 788 |
| Daimler Eight (SWB) | 164 |
| Daimler Eight (LWB) | 2.119 |
| Daimler Super V8 (SWB) | 76 |
| Daimler Super V8 (LWB) | 2.387 |
| Total | 126.260 |

The catalogue for all classic car makes

- Accessories
- Workshop tools
- Oil and grease
- Books
- Car Care
- Consumables
- Equipment
- Classic seat belts

Old Love never dies

560 pages



Part no. 15119 (English)
Part no. 492147 (German)
Part no. 491321 (French)

Our new catalogues ! Now with online order function !

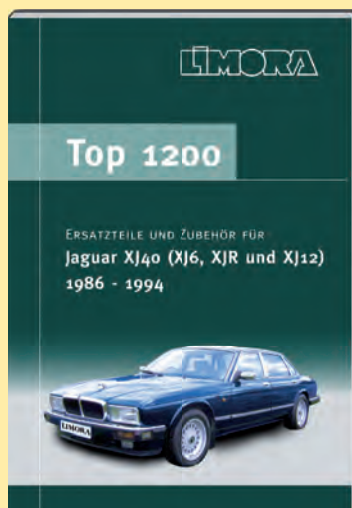

English Part no. 293080
German Part no. 343299
French Part no. 499191



English Part no. 497252
German Part no. 497251
French Part no. 497253



English Part no. 496826
German Part no. 493838
French Part no. 496827

Catalogue FOR FREE online:



1. CYLINDER BLOCK, OIL SUMP AND CRANKSHAFT

1. OIL FILTER

Spin on type

X308 3.2 and 4.0 from VIN...812317 to F59525
Jaguar oil filter Part no. 329247
Reproduction Part no. 256255

Matching FilterMag
in Chapter 21.1



1.

2. BLANKING PLUG

Oil drain

X308 3.2 and 4.0 from VIN...812317 to 878717
Part no. 424803



2.

3. BLANKING PLUG

Oil drain

including sealing washer
X308 3.2 and 4.0 from VIN...F00035 to F59525
Part no. 281190



3.

Matching oil drain valve
in Chapter 21.1



5. IDLER PULLEY

for engine drive belt

Mounted to alternator bracket
X308 3.2 and 4.0 from VIN...F00035 to F59525
Part no. 374357



5.



6.

6. TENSION PULLEY

Tension pulley for engine drive belt

Mounted to steering pump
X308 3.2 and 4.0 from VIN...F00035 to F59525
Part no. 435143

4. CONVERSION KIT

for engine drive belt

X308 3.2 and 4.0 from VIN...812317 to 878717
Improved version idler pulley and tension pulley made from high quality steel
Part no. 286013



4.

7. DRIVE BELT ENGINE

multi groove type with 7 grooves

X308 (XJ8) 3.2 and 4.0 except Supercharged from VIN...F00035 to F59525,
X308 (XJ8) 4.0 Supercharged from VIN...853936 to F59525
Part no. 434967



7.

8. CONVERSION KIT

for supercharger drive belt

X308 4.0 Supercharged
from VIN...812317 to F59525

Improved version idler pulley and tension pulley
made from high quality steel
Part no. 495238



8.

9. CONVERSION GASKET SET

with oil seals

X308 3.2 and 4.0 from VIN...812317 to F59525
Part no. 278598



9.

10. OIL SUMP GASKET

X308 (X18) 3.2 and 4.0
from VIN...812317 to F59525
Part no. 285942

10.

11. OIL SEAL

crankshaft front

X308 3.2 and 4.0 from VIN...812317 to F59525
Part no. 434965



11.

12. OIL SEAL

crankshaft rear

X308 3.2 and 4.0 from VIN...812317 to F59525
Part no. 434922



12.

13. ELRING SEALING COMPOUND

Curil K2 - non hardening.

Permanently plastic, particularly adhesive, for highly stressed sealing joints. Recommended for the fitting of oil seals
75 ml tube. Part no. 5590



13.

1. CYLINDER BLOCK, OIL SUMP AND CRANKSHAFT

X308 (XJ8) 3.2 and 4.0 to August 2001 (to engine no. 0108122359)

14. TIMING CHAIN

crankshaft - primary chain

Qty. required: 2 Part no. 256252

15. TIMING CHAIN TENSIONER

for primary timing chain

Qty. required: 2 Part no. 374363

16. PAD

for tensioner on primary timing chain - plastic

Qty. required: 2 Part no. 285949

17. GUIDE

for primary timing chain - plastic

Qty. required: 2 Part no. 434956



X308 3.2 and 4.0 from engine no. 0108130000

18. TIMING CHAIN

crankshaft - primary chain

Qty. required: 2 Part no. 374358

19. TIMING CHAIN TENSIONER

for primary timing chain

Qty. required: 2 Part no. 374363

20. PAD

for tensioner on primary timing chain - steel

Qty. required: 2 Part no. 489930

21. GUIDE

for primary timing chain - steel

Qty. required: 2 Part no. 374364



Secondary timing chains
see chapter 21.1



22. TIMING CHAIN KIT

complete engine set

X308 (XJ8) 3.2 and 4.0 - to August 2001 (to engine no. 0108122359)

Part no. 492434

As a result of problematic timing chain tensioner design and other factors like engine overheating or poor maintenance, the plastic cam chain tensioners on 1997 to 2002 V8 Jaguars began to experience stress fractures, and so did some of the plastic guides. While the cars were under warranty, many tensioners were replaced by Jaguar service departments with improved components. Engines subject to this problem include XJ8/XJR engines with the last six digits of their VIN numbers between 812317 and F41862. In the 2002 model year Jaguar began installing upgraded plastic tensioners. These second-generation units are, to the best of our knowledge, more reliable than the early version.



22.

23. NGK SPARK PLUG

X308 (XJ8) 3.2 and 4.0 except Supercharged from VIN...812317 to 853935

Qty. required: 8 Part no. 435116

X308 (XJ8) 3.2 and 4.0 except Supercharged from VIN...853936 to F59525

Qty. required: 8 Part no. 356293

X308 (XJ8) 4.0 Supercharged from VIN...812317 to 878717

Qty. required: 8 Part no. 435120

X308 (XJ8) 4.0 Supercharged from VIN...F00035 to F59525

Qty. required: 8 Part no. 356293



23.



23.

24. ENGINE MOUNTING

hydraulic

X308 (XJ8) 3.2 and 4.0 from VIN...812317 to F595255

Qty. required: 2 Part no. 434490



24.

Jaguar's recommendation for:

X308 3.2 and 4.0 from VIN...812317 to F59525

25. CASTROL FULL SYNTHETIC OIL
Edge SAE 0W/40
5 litre canister . . . Part no. 496772

Castrol EDGE 0W-40 A3/B4 gives you the confidence to demand maximum engine performance from today's modern, higher revving sports, performance and luxury vehicles requiring lower viscosity higher performance oils.

Product benefits:

- Helps to maximise short and long term engine performance
- Improves engine efficiency, independently tested
- Delivers excellent levels of protection across a variety of driving conditions and temperatures
- Reduces engine deposits to help maximise engine response

Technical specifications and approvals:

- SAE 0W-40,
- ACEA A3/B3,
- A3/B4,
- API SN/CF
- VW 502 00/ 505 00
- BMW Longlife-01
- MB-approved 229.3/ 229.5
- Porsche A40
- Suits Ford WSS -M2C937-A
- Peugeot B71 2296

26. CASTROL FULL SYNTHETIC OIL
Magnatec SAE 5W/30 C3
5 litre canister . . . Part no. 472241

Castrol Magnatec 5W-30 A3/B4 intelligent molecules cling to critical engine parts to provide an extra layer of protection. With up to 75% of engine wear happening whilst your engine's warming up, Castrol Magnatec's molecules are always there, always ready, drastically reducing engine wear during this critical start-up and warm-up period. Castrol Magnatec 5W-30 A3/B4 combining Intelligent Molecules and fully synthetic technology: Clings to your engine forming an extra layer that protects during warm-up and beyond. Bonds to metal surfaces making engine parts more resistant to wear. Combine with synthetic technology to provide increased protection in high and low temperature applications.

Technical specifications and approvals:

- API SM/CF
- ACEA A3/B3, A3/B4, C3
- GM-LL-A-025
- GM-LL-B-025
- BMW approval Longlife-01
- MB approval 229.31
- RENAULT approval RN0700
- VW approval 502 00 u. 505 00
- FIAT approval 9.55535-G1
- JAGUAR approval WSS-M2C913-B

27. CASTROL FULL SYNTHETIC OIL
Magnatec SAE 10W/40 A3/B4
5 litre canister . . . Part no. 472236

Castrol Magnatec combines Intelligent Molecules with part synthetic technology to instantly protect, from the moment you turn the key.

Product benefits:

- Clings to your engine forming an extra layer that protects during warm-up and beyond
- Bonds to metal surfaces making engine parts more resistant to wear
- Provide protection for all driving conditions and styles

Technical specifications and approvals:

- ACEA A1/B1
- API SL
- Meets Ford WSS-M2C925-A and Ford WSS-M2C925-B
- Meets engine test requirements of A5/B5
- ILSAC GF-3

28. CASTROL ENGINE OIL
GTX 10W-40 with HC-synthetic base oils
5 litre canister . . . Part no. 472186

The Castrol GTX product range features lubricants for vehicles with proven engine technology and provides a balanced performance under all types of conditions. In addition, GTX High Mileage A3/B3 is a product which was designed especially for engines with a mileage of over 70.000 miles (100.000 km). Protect your car from harmful sludge with Castrol GTX 10W-40 A3/B4 which contains anti-sludge formula that provides 25% better sludge protection compared to tough industry standards. Castrol GTX provides 25% better protection against sludge than the latest industry standard. Liquid Engineering protects against problems that your engine faces every day.

Product benefits:

vs API SL &/or ACEA A3/B4 Industry standards

Technical specifications and approvals:

- API SL/CF
- ACEA A3/B4
- VW 501 01/505 00
- MB-approval 229.1
- Fiat 9.55535.D2



capacity motor oil: 6.5 litre, or 7.5 litre with oil cooler

1. CYLINDER HEAD GASKET SET

X308 3.2 and 4.0 except Supercharged from VIN...812317 to F59525
Part no. 277706

X308 4.0 Supercharged from VIN...812317 to F59525
Part no. 422409

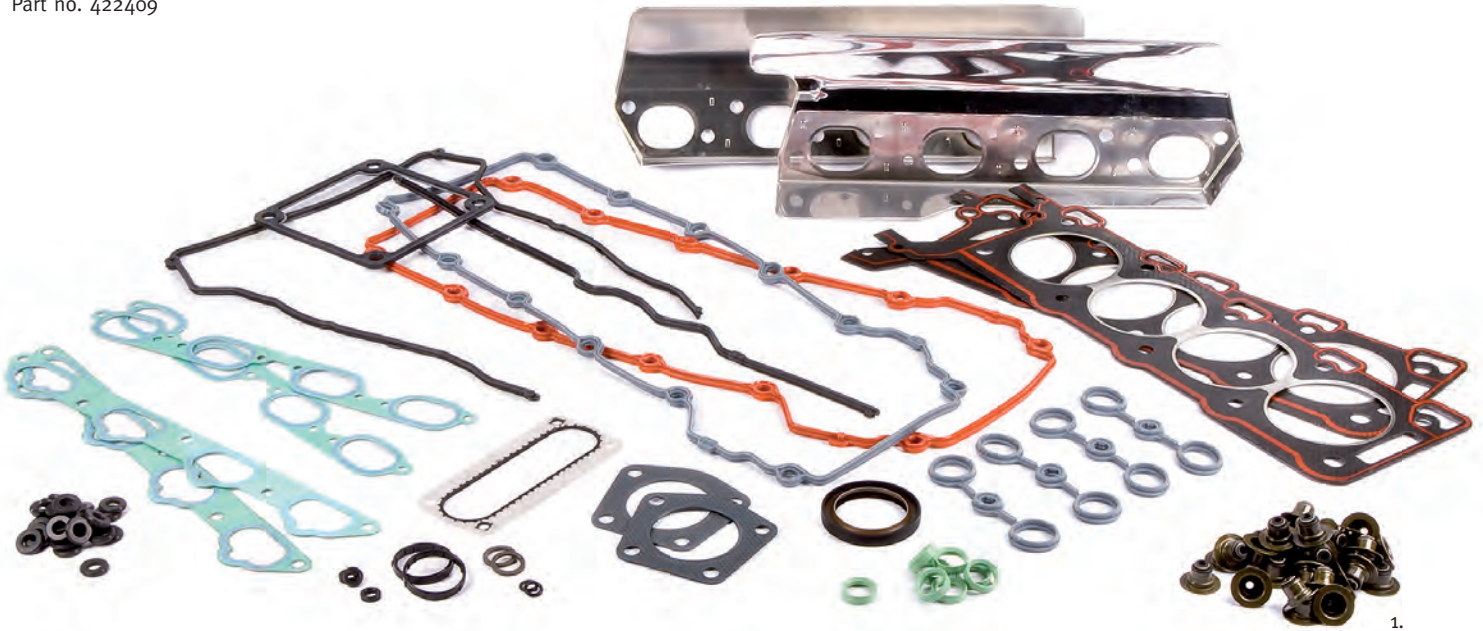

1.



2.

2. CYLINDER HEAD GASKET

X308 (XJ8) 3.2 and 4.0 from engine no. 0008210148 to 0008311116 and from engine no. 0008311707
LH side (,B' bank) Part no. 435216
RH side (,A' bank) Part no. 435214

X308 (XJ8) 3.2 and 4.0 from engine no. 0008210148 to 0008311116
LH side (,B' bank) Part no. 487120
RH side (,A' bank) Part no. 487121

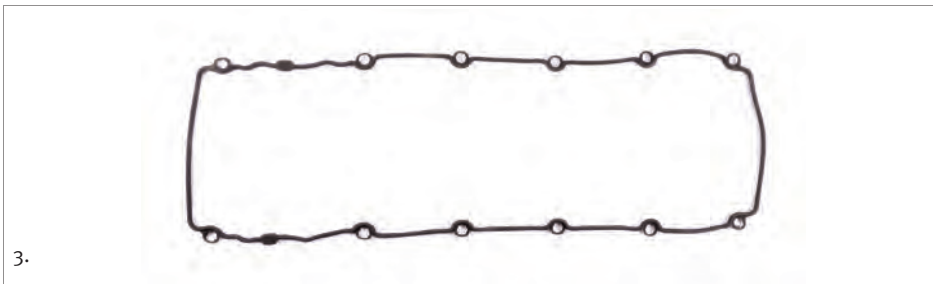

3.

X308 (XJ8) 3.2 and 4.0 from engine no. 0008210148 to 0008311116 and from engine no. 0008311707
LH side (,B' bank) Part no. 435216
RH side (,A' bank) Part no. 435214

X308 (XJ8) 3.2 and 4.0 from engine no. 0008210148 to 0008311116 and from engine no. 0008311707
LH side (,B' bank) Part no. 435216
RH side (,A' bank) Part no. 487121

3. GASKET

camshaft cover

X308 (XJ8) 3.2 and 4.0 to engine no. 9810290000
LH side (,B' bank) Part no. 434987
RH side (,A' bank) Part no. 434985

X308 (XJ8) 3.2 and 4.0 to engine no. 9803250000
LH side (,B' bank) Part no. 435294
RH side (,A' bank) Part no. 435293

4. CYLINDER HEAD BOLT

X308 (XJ8) 3.2 and 4.0 from VIN...812317 to F59525
Qty. required: 10 Part no. 285981



4.

These so-called stretch bolts are specifically designed to give a set length under the right torque. As such they should never be used a second time. The desired bias requires careful installation. The cylinder head bolts are assembled in several stages with a specific tightening torque. When this torque is reached, the bolts are turned further through a defined angle which pre-loads them into a plastic region. We recommend that new cylinder head stretch bolts be used and any work carried out to your engine is done in accordance with a factory workshop manual. Whilst you are doing this job we consider it advisable to replace the water pump and expansion cap to minimise any future problems.

2. CYLINDER HEAD, CAMSHAFT AND TIMING BELT

5. RUBBER SEALING RING
spark plug to cylinder head

X308 (XJ8) 3.2 and 4.0
to engine no. 9810290000
Qty. required: 4 Part no. 285978



6. RUBBER SEALING RING
spark plug to cylinder head

X308 (XJ8) 3.2 and 4.0
from engine no. 9803250000
Qty. required: 8 Part no. 435356



7. RUBBER SEALING RING
spark plug to cylinder head

X308 (XJ8) 3.2 and 4.0
from engine no. 9803250000
Qty. required: 4 Part no. 492964



8. MANIFOLD GASKET

X308 (XJ8) 3.2 and 4.0
from VIN...812317 to F59525
exhaust manifold to LH cylinder head
(B' bank) Part no. 435090
exhaust manifold to RH cylinder head
(A' bank) Part no. 435089



8.

Thermostat housing and cover

including closure and seals. Exact reproduction in aluminum:
Now heat-resistant and durable...

9. THERMOSTAT HOUSING

X308 (XJ8) 3.2 and 4.0 except Supercharged
from VIN...812317 to F59525
Part no. 488148

This upgrade kit replaces the original plastic thermostat housing. We have put together an aluminum thermostat housing assembly, more durable than its plastic counterpart. This kit will include the housing, cap, thermostat cover and seals. This is an exact replacement of the plastic version and will meet or exceed the factory specifications.



9.

10. THERMOSTAT

84° C - including ,O' ring
X308 (XJ8) 3.2 and 4.0
from VIN...812317 to F59525
Part no. 487154



10.



11.

12. TIMING CHAIN KIT

complete engine set
X308 (XJ8) 3.2 and 4.0 - to August 2001
(to engine no. 0108122359)
Part no. 492434



12.

13. TIMING CHAIN

camshaft - secondary chain

X308 (XJ8) 3.2 and 4.0

to engine no. 0108122359 (to August 2001)

Qty. required: 2 Part no. 256253

X308 (XJ8) 3.2 and 4.0 from engine no.

0108130000 to VIN...F59525 (from August 2001)

Qty. required: 2 Part no. 374359



13.

14. TIMING CHAIN TENSIONER

secondary timing chain

X308 (XJ8) 3.2 and 4.0

from VIN...812317 to F59525

LH side (B' bank) Part no. 348526

RH side (A' bank) Part no. 348527



14.
LH side



14.
RH side

Complete timing chain kit
in Chapter 1.1 Illustration 24



1. GASKETS AND OIL SEALS

1. GEARBOX GASKET SET

automatic transmission

X308 4.0 Supercharged
from VIN...812317 to F59525
Part no. 422165



1.

2. OIL SUMP GASKET

automatic transmission

X308 4.0 Supercharged
from VIN...812317 to F59525
Part no. 348903

X308 3.2 and 4.0 except Supercharged
from VIN...812317 to F59525
Part no. 421873



2.

3. OIL STRAINER

automatic transmission

X308 4.0 Supercharged
from VIN...812317 to F59525
Part no. 348938

X308 3.2 and 4.0 except Supercharged
from VIN...812317 to F59525
Part no. 355911

with ,O' ring and sump gasket assembly

X308 3.2 and 4.0 except Supercharged
from VIN...812317 to F59525
Part no. 497247



3.

5. DRAIN PLUG

automatic transmission

X308 4.0 Supercharged
from VIN...812317 to F59525
Part no. 421945

X308 3.2 and 4.0 except Supercharged
from VIN...812317 to F59525
Part no. 421874

6. COPPER WASHER

drain plug

X308 4.0 Supercharged
from VIN...812317 to F59525
Part no. 422160



5.



6.

4. ,O' RING

for oil strainer

X308 3.2 and 4.0 except Supercharged
from VIN...812317 to F59525
Part no. 421885



4.

7. OIL SEAL

front oil pump, automatic transmission

X308 3.2 and 4.0 except Supercharged
from VIN...812317 to F59525
Part no. 279260



7.



9.

9. OIL SEAL

output shaft, automatic transmission

X308 3.2 and 4.0 except Supercharged
from VIN...812317 to F59525
Part no. 421880

8. OIL SEAL

selector shaft

X308 3.2 and 4.0 except Supercharged
from VIN...812317 to F59525
Part no. 279426



8.



10.

10. ,O' RING

rear housing

X308 3.2 and 4.0 except Supercharged
from VIN...812317 to F59525
Part no. 421879

11. GEARBOX MOUNTING RUBBER

X308 4.0 Supercharged

from VIN...812317 to F59525

Qty. required: 2 Part no. 434124

X308 3.2 and 4.0 except Supercharged

from VIN...812317 to F59525

Qty. required: 2 Part no. 434492



11.

12. AUTOMATIC GEARBOX OIL

X308 4.0 Supercharged

from VIN...812317 to F59525

1 litre bottle Part no. 348154

capacity automatic gearbox: **10 litre**



12.

13. AUTOMATIC GEARBOX OIL

X308 3.2 and 4.0 except Supercharged

from VIN...812317 to F59525

1 litre bottle Part no. 421900

capacity automatic gearbox: **10 litre**



13.

14. ELRING SEALING COMPOUND

Curil - hardening

50 ml tube Part no. 486957



Curil - the hardening sealing compound. For sealing against mineral oils, water, gases, air and many chemicals. It is a general seal for application either alone, or together with other metal, or soft sealing materials. It should be kept in a cool atmosphere. Do not bring in contact with food. Clean the surfaces to be sealed from grease and dirt, then apply Curil thinly and after 10 to 15 minutes put the two surfaces together. Temperature range: from about -40° C to about +180° C.



16.

16. GASKET REMOVER

400 ml aerosol Part no. 310836

Dissolves sealants and sticking remnants as well as synthetic resin, varnishes quickly and thoroughly. High time-saving by strong solution effect. Extremely quick and effective.

15. ELRING GASKET PAPER

for individual self-production of seals

Contents: 6 sheets of gasket fibre, strength 0,25 mm, 0,5 mm, 0,75 mm, 1,00 mm, 1,25 mm dimensions 210 x 300 mm Part no. 361300



We recommend to use with sealing compound set Part no. 486959

1. RADIATOR, THERMOSTAT AND WATER PUMP

Thermostat housing and cover

including closure and seals. Exact reproduction in aluminum:
Now heat-resistant and durable...

1. THERMOSTAT HOUSING

X308 3.2 and 4.0 except Supercharged from VIN...812317 to F59525
Part no. 488148

Thermostat housing with cover. This upgrade kit replaces the original plastic thermostat housing. We have put together an aluminum thermostat housing assembly, more durable than its plastic counterpart. This kit will include the housing, cap, thermostat cover and seals. This is an exact replacement of the plastic version and will meet or exceed the factory specifications.



1. THERMOSTAT HOUSING

84° C - including ,O' ring

X308 3.2 and 4.0 from VIN...812317 to F59525
Part no. 487154

3. ,O' RING
thermostat - separately
Part no. 285960



2. THERMOSTAT

7. RUBBER BUSH
radiator, top mounting

X308 3.2 and 4.0 from VIN...812317 to F59525
Qty. required: 2 Part no. 434315

8. PACKING
radiator, bottom mounting

X308 3.2 and 4.0 from VIN...812317 to F59525
Qty. required: 2 Part no. 434314



7.



8.

4. WATER PUMP

X308 3.2 and 4.0 from VIN...812317 to F59525
Part no. 347746



4.

5. GASKET

water pump

X308 3.2 and 4.0 from VIN...812317 to F59525
thickness: 0.4 mm Part no. 487153
thickness: 1.5 mm. Part no. 355851



5.

6. RADIATOR

with high efficiency aluminium cord, new

X308 3.2 and 4.0 from VIN...812317 to 832727
Part no. 355344

X308 3.2 and 4.0 from VIN...832728 to F59525
Part no. 434311



6.

9. FILLER CAP

expansion tank

X308 3.2 and 4.0 from VIN...812317 to F59525
Part no. 284052



9.

10. FLUID LEVEL SENSOR

expansion tank

X308 3.2 and 4.0 from VIN...812317 to F59525
Part no. 283284



10.

11. RADIATOR HOSE

top

X308 3.2 and 4.0 except Supercharged from VIN...812317 to F59525
Part no. 434328

X308 4.0 Supercharged from VIN...812317 to F59525
Part no. 434329



11.

12. RADIATOR HOSE

bottom

X308 3.2 and 4.0 except Supercharged from VIN...812317 to F59525
Part no. 434332

X308 4.0 Supercharged from VIN...812317 to F59525
Part no. 434338



12.



12.

16. JAGUAR ANTI-FREEZE COOLANT

radiator. Specification: DOW D542

X308 3.2 and 4.0 from VIN...812317 to VIN...F00034
1 litre bottle Part no. 422089
5 litre can Part no. 422090

17. JAGUAR ANTI-FREEZE COOLANT

radiator. Specification: WSS M97B44-D

X308 3.2 and 4.0 from VIN...F00035 to F59525
1 litre bottle Part no. 422635
5 litre bottle Part no. 422090

Cooling system capacity: 10 litres



17.

13. HOSE CLIP

for hoses

X308 3.2 and 4.0 from VIN...812317 to F59525
from 20 to 23 mm diameter. . . . Part no. 273411
from 23 to 27 mm diameter. . . . Part no. 273407
from 41 to 50 mm diameter. . . . Part no. 417544
from 47 to 58 mm diameter. . . . Part no. 417547



13.

14. CLAMP

radiator hose

X308 4.0 Supercharged from VIN...812317 to F59525
Part no. 424905



15. ELECTRIC FAN

with cowl assembly

X308 3.2 and 4.0 from VIN...812317 to F59525
Part no. 434319



15.

2. SUPERCHARGER COOLING SYSTEM

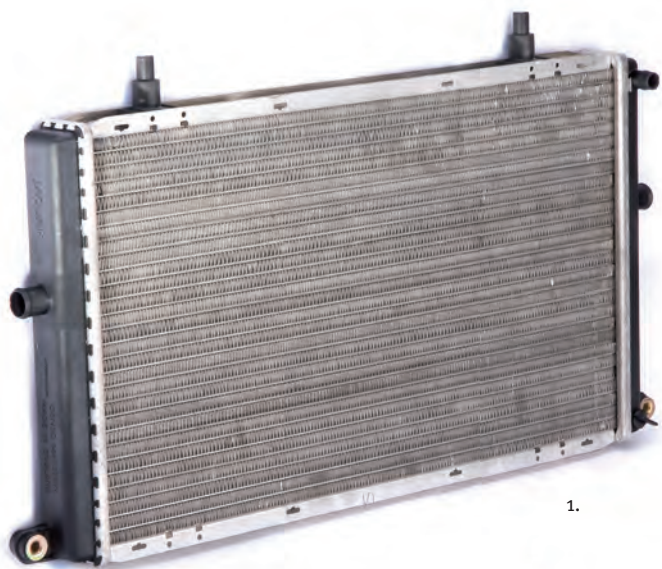

1.

1. SUPERCHARGER RADIATOR

X308 4.0 Supercharged from VIN...812317 to F59525
Part no. 434509



2.

2. RUBBER BUSH

supercharger radiator, bottom mounting

X308 4.0 Supercharged from VIN...812317 to F59525
Part no. 209402

3. RADIATOR HOSE

supercharger to supercharger radiator

X308 4.0 Supercharged from VIN...812317 to F59525
Part no. 348144



3.

4. RADIATOR HOSE

supercharger radiator to coolant pump

X308 4.0 Supercharged from VIN...812317 to F59525
Part no. 434513



4.

5. WATER PUMP

supercharger

X308 4.0 Supercharged from VIN...812317 to F59525
Part no. 434518



5.

6. HOSE CLIP

Spring band type

X308 (XJ8) 3.2 and 4.0 von VIN...812317 bis F59525

20 to 23 mm diameter Part no. 273411
from 23 to 27 mm diameter. Part no. 273407
from 26 to 29 mm diameter. Part no. 417545



6.

7. JAGUAR ANTI-FREEZE COOLANT

radiator. Specification: DOW D542

X308 3.2 and 4.0 from VIN...812317 to VIN...F00034

1 litre bottle Part no. 422089
5 litre can Part no. 422090

8. JAGUAR ANTI-FREEZE COOLANT

radiator. Specification: WSS M97B44-D

X308 3.2 and 4.0 from VIN...F00035 to F59525

1 litre bottle Part no. 422635
5 litre can Part no. 422090



7.



8.

Cooling system capacity: 10 litres

1. ACCELERATOR CABLE AND ENGINE SENSORS

1. THERMAL TRANSMITTER
air inlet

X308 4.0 Superrcharged
from VIN...812317 to F59525
Part no. 424980



2. THERMAL TRANSMITTER
coolant, for thermostat housing

X308 3.2 and 4.0
from VIN...853936 to F41862
Identify by 2 pin compact
connector with grey plastic
cap, M18 thread with 19 mm
spanner size and cylindrical
transmitter without peak

Qty. required: 2
Part no. 433165



3. THERMAL TRANSMITTER
coolant, for thermostat housing

X308 3.2 and 4.0
from VIN...F41863 bis F59525
Identify by 2 pin compact
connector with green plastic
cap, M12 thread with 19 mm
spanner size and cylindrical
transmitter without peak
Part no. 282644

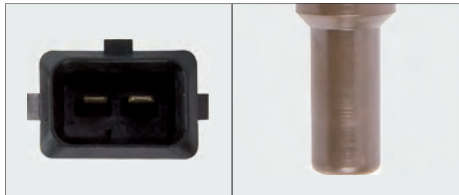

4. TEMPERATURE SENSOR
oil temperature

X308 3.2 and 4.0
from VIN...853936 to F59525
Identify by 2 pin compact con-
nector with grey plastic cap, M18
thread with 19 mm spanner size
and cylindrical transmitter without
peak
Part no. 433165



5. OIL PRESSURE SWITCH

X308 3.2 and 4.0
from VIN...812317 to F59525
identify by 1 pin compact
connector with black plastic
cap, M10 thread with 21 mm
spanner size
Part no. 374530



6. ACCELERATOR CABLE

X308 3.2 and 4.0 from VIN...812317 to F59525
LHD Part no. 434545
RHD Part no. 434542



6.



1. ACCELERATOR CABLE AND ENGINE SENSORS

7. SENSOR

to detect engine speed and crankshaft position.
Fitted to oil sump

X308 3.2 and 4.0
from VIN...812317 to 853935
Part no. 281639

X308 3.2 and 4.0
from VIN...853936 to F59525
Part no. 374263



8. SENSOR

to detect camshaft position.
Fitted to RH camshaft cover

X308 3.2 and 4.0 from VIN...812317 to 853935
Part no. 281640

X308 3.2 and 4.0 from VIN...853936 to F59525
LH (B' bank) Part no. 348093
RH (A' bank) Part no. 348153



8.

Did you know... ?

The crankshaft sensor is an inductive type sensor. It consists of a magnet and a coil wound around the magnet. It is triggered by reference points passing the sensor tip. The reference points can be pins mounted to the flywheel in the form of a trigger disc or reluctor. These will divide the 360 degrees rotation of the engine into segments that the engine control can use for the ignition system or for the start of injection. Each time a reference point passes the tip of the sensor it disturbs the magnetic field creating an AC voltage in the coil. The AC voltage is sent as a signal voltage back to the engine control unit. The crankshaft sensor or engine speed sensor will have 2 or 3 pins. The 3rd pin is used for a screen. The screen suppresses any interference. The engine management light will be triggered if the crankshaft sensor moves outside of normal operating values. A fault with this sensor may inhibit engine startup.



9. KNOCK SENSOR

X308 3.2 and 4.0 except Supercharged
from VIN...812317 to 853935, X308 4.0 Superch-
arged from VIN...812317 to 878717
Qty. required: 2 Part no. 424975

X308 3.2 and 4.0 except Supercharged
from VIN...853936 to F59525,
X308 4.0 Supercharged
from VIN...F00035 to F59525
Part no. 431316



9.



10. CONTROL VALVE

for variable valve timing

X308 3.2 and 4.0 from VIN...812317 to F59525
Qty. required: 2 Part no. 281636



10.

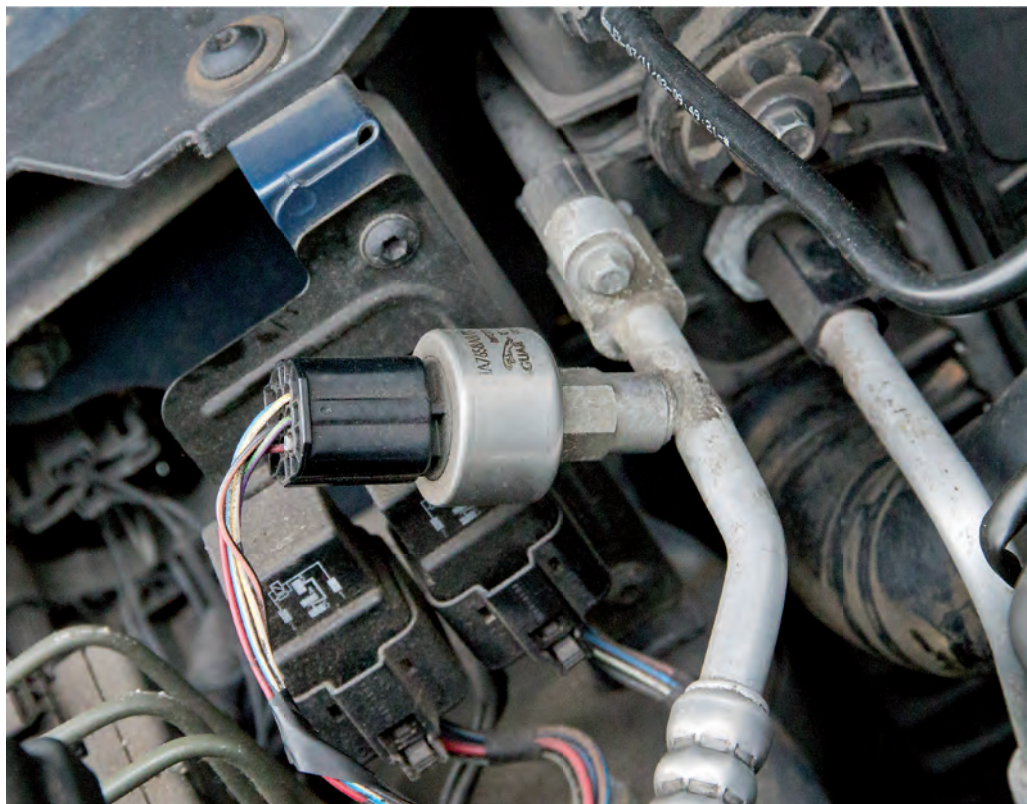

11. LAMBDA OXYGEN SENSOR

heated, fitted in front of the catalytic converter

X308 3.2 and 4.0 with OBD II interface except Supercharged from VIN...812317 bis 853935, X308 4.0 Supercharged from VIN...812317 to 878717

Qty. required: 2 Part no. 282083

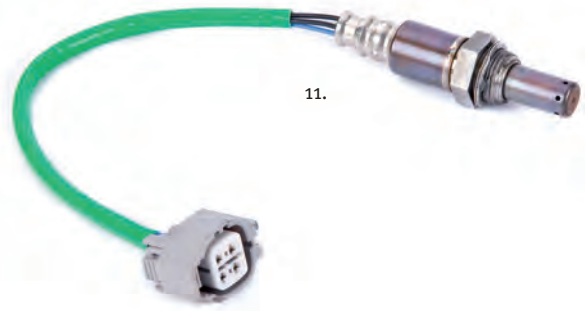

11.

X308 3.2 and 4.0 except Supercharged

from VIN...F06183 to F59252, X308 4.0 Supercharged from VIN...F00035 to F59525

Qty. required: 2 Part no. 431315

12. LAMBDA OXYGEN SENSOR

heated, fitted behind of the catalytic converter

X308 3.2 and 4.0 from VIN...812317 to F59525

Qty. required: 2 Part no. 431313

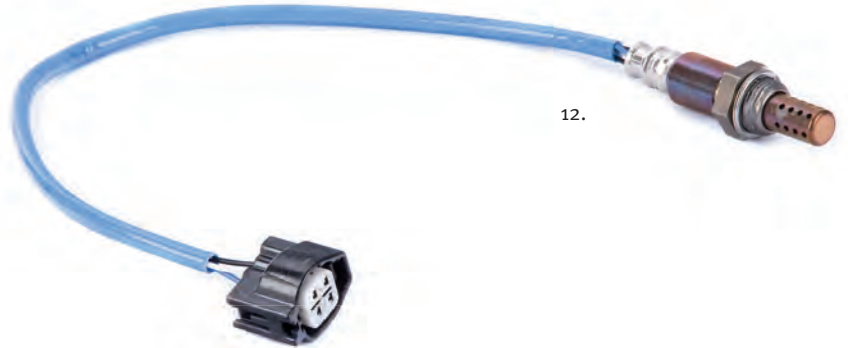

12.

13. LAMBDA SENSOR TESTER

with a fast 20 segment LED display covering a range from 0 to 1 volt. Suitable for cars with electronic fuel injection and catalytic converters. Also useful for testing the ECU injection control unit. Can be simply connected to the on board 12 volt battery with the 2 crocodile clamps. Prevents catalytic converter damage and provides an optimal fuel/air mixture



13.

14. LAMBDA SENSOR CHASER

for cleaning and restoring the sensor bore threads, M18 x 1.5 mm. Can be installed using spark plug wrench or 21 mm socket Part no. 471256



14.

15. SPECIAL SOCKET

For lambda oxygen sensors with 22 mm spanner size. The cut out socket provides a good grip without damaging the sensor cable, 3/8" drive Part no. 469795



15.

1. FUEL INJECTORS, MANIFOLD GASKETS, THROTTLE BODY AND AIR FILTER

1. AIR FILTER

element

X308 3.2 and 4.0 from VIN...812317 to F59525
Part no. 355795



1.

K&N filter in Chapter 21.1



2. AIR-FLOW METER

X308 3.2 and 4.0 except Supercharged from VIN...812317 to 853935
Part no. 282080

X308 3.2 and 4.0 except Supercharged from VIN...853936 to F59525
Part no. 431311

X308 4.0 Supercharged from VIN...812317 to 878717
Part no. 429597

X308 4.0 Supercharged from VIN...F00035 to F59525
Part no. 431309

3. SEAL

between air-flow meter and air pipe

X308 3.2 and 4.0 from VIN...812317 to F59525
Part no. 435436

4. THROTTLE BODY

X308 3.2 and 4.0 non Supercharged models without air assisted fuel injection from VIN...812317 to F59525
Part no. 424979

X308 3.2 and 4.0 non Supercharged models with air assisted fuel injection from VIN...853936 to F59525
Part no. 431305

X308 4.0 Supercharged from VIN...812317 to 878717
Part no. 424979

X308 4.0 Supercharged from VIN...F00035 to F59525
Part no. 431306



4.

5. FUEL INJECTOR

X308 3.2 and 4.0 except Supercharged from VIN...812317 to 853935
Qty. required: 8 Part no. 424973

X308 3.2 and 4.0 except Supercharged from VIN...853936 to F59525
Qty. required: 8 Part no. 374503

X308 4.0 Supercharged from VIN...812317 to F59525
Qty. required: 8 Part no. 424978



5.



2.

3.

6. O² RING SET

fuel injector to fuel rail

X308 3.2 and 4.0 except Supercharged from VIN...812317 to F59525
Qty. required: 8 Part no. 421939

7. SEALING RING

fuel injector to adaptor

X308 4.0 Supercharged from VIN...812317 to F59525
Qty. required: 8 Part no. 435227



6.

6.

7.

8. RETAINING CLIP

fuel injector

X308 3.2 and 4.0 from VIN...853936 to F59525
Qty. required: 8 Part no. 436375

9. RETAINING CLIP

fuel injector

X308 4.0 Supercharged from VIN...812317 to F59525
Qty. required: 8 Part no. 374235



8.

9.



1. FUEL INJECTORS, MANIFOLD GASKETS, THROTTLE BODY AND AIR FILTER

10. FUEL PRESSURE REGULATOR

X308 3.2 and 4.0 except Supercharged from VIN...812317 to 853935
Part no. 285989

with ,O' rings assembly

X308 3.2 and 4.0 except Supercharged from VIN...853936 to F59525
Part no. 436427

X308 4.0 Supercharged from VIN...812317 to F59525
Part no. 285989

11. ,O' RING SET

fuel pressure regulator 436427 to pipe

X308 3.2 and 4.0 except Supercharged from VIN...853936 to F59525
Part no. 422993



14. MANIFOLD GASKET

inlet manifold to manifold adaptor

X308 4.0 Supercharged from VIN...812317 to F59525
Qty. required: 2 Part no. 435228

12. MANIFOLD GASKET

inlet manifold to cylinder head

X308 3.2 and 4.0 except Supercharged to VIN...853935
Qty. required: 8 Part no. 285992

X308 3.2 and 4.0 except Supercharged from VIN...853936 to F59525
Qty. required: 8 Part no. 374451



13. RUBBER SEAL

inlet manifold to induction elbow

X308 3.2 and 4.0 except Supercharged from VIN...812317 to F59525
Qty. required: 2 Part no. 285990



15. MANIFOLD GASKET

inlet manifold adaptor to cylinder head

X308 4.0 Supercharged from VIN...812317 to F59525
Qty. required: 2 Part no. 435229



1. FUEL INJECTORS, MANIFOLD GASKETS, THROTTLE BODY AND AIR FILTER

16. RUBBER SEAL

inlet manifold to induction elbow

X308 4.0 Supercharged from VIN...812317 to F59525

Part no. 435226



16.

17. MANIFOLD GASKET

exhaust manifold

X308 3.2 and 4.0 from VIN...812317 to F59525

LH cylinder head

(B' bank) Part no. 435090

RH cylinder head

(A' bank) Part no. 435089



17.

Oldtimer-Warenhaus

Feldstraße 41
 D - 52070 Aachen
 Tel: +49 (0) 241 - 55 939 0
 Fax: +49 (0) 241 - 55 939 20
 E-Mail: Aachen@Limora.com

**Have you time to drop by?
 We look forward to seeing you.**

- Parts
- Tools
- Oil and grease
- Accessories
- Books
- Car care
- Consumables
- Seatbelts

**Amost 600 Square Metres.
 The first Limora Vintage store !**



1. FUEL PUMP, FUEL FILTER AND SENDER UNIT

1. FUEL FILTER

original Jaguar

X308 3.2 and 4.0 from VIN...812317 to F59525
Part no. 286301



1. original

2. FUEL FILTER

reproduction

X308 3.2 and 4.0 from VIN...812317 to F59525
Part no. 319649



2. reproduction

3. O' RING

fuel filter

X308 3.2 and 4.0 from VIN...812317 to F59525
Qty. required: 2 Part no. 319649



3.

4. FUEL FILLER CAP

X308 3.2 and 4.0 from VIN...812317 to 878717
Part no. 257484



4.

5. FUEL FILLER CAP

X308 3.2 and 4.0 from VIN...F00035 to F20644
Part no. 436479



5.

6. FUEL FILLER CAP

X308 3.2 and 4.0 from VIN...F20645 to F59525
Part no. 436480



6.

7. FUEL PUMP

original Jaguar - less filter

X308 3.2 and 4.0 except Supercharged from VIN...812317 to F59525
Qty. required: 1. Part no. 487122



7.

X308 4.0 Supercharged from VIN...812317 to F59525

Qty. required: 2 Part no. 487122

8. FUEL PUMP

reproduction - less filter

X308 3.2 and 4.0 except Supercharged from VIN...812317 to F59525
Qty. required: 1. Part no. 491431



8.

X308 4.0 Supercharged from VIN...812317 to F59525

Qty. required: 2 Part no. 491431

9. FILTER

inside fuel pump

X308 3.2 and 4.0 except Supercharged from VIN...812317 to F59525
Qty. required: 1. Part no. 435671



9.

X308 4.0 Supercharged from VIN...812317 to F59525

Qty. required: 2 Part no. 435671

1. FUEL PUMP, FUEL FILTER AND SENDER UNIT

10. FUEL SENDER UNIT

X308 3.2 and 4.0 from VIN...812317 to F59525
Part no. 210253

11. SEALING RUBBER

fuel sender unit

X308 3.2 and 4.0 from VIN...812317 to F59525
Part no. 747

12. LOCKING RING

fuel sender unit

X308 3.2 and 4.0 from VIN...812317 to F59525
Part no. 4156

13. SEALING RING

evaporative loss flange to tank

X308 3.2 and 4.0 from VIN...812317 to F59525
Part no. 286418



13.

14. RETAINING CLIP

fuel pipe

X308 3.2 and 4.0 from VIN...812317 to F59525
Qty. required: 6 Part no. 286488

15. RETAINING CLIP

fuel pipe

X308 3.2 and 4.0 from VIN...812317 to F59525
Qty. required: 3 Part no. 281488



14.

15.

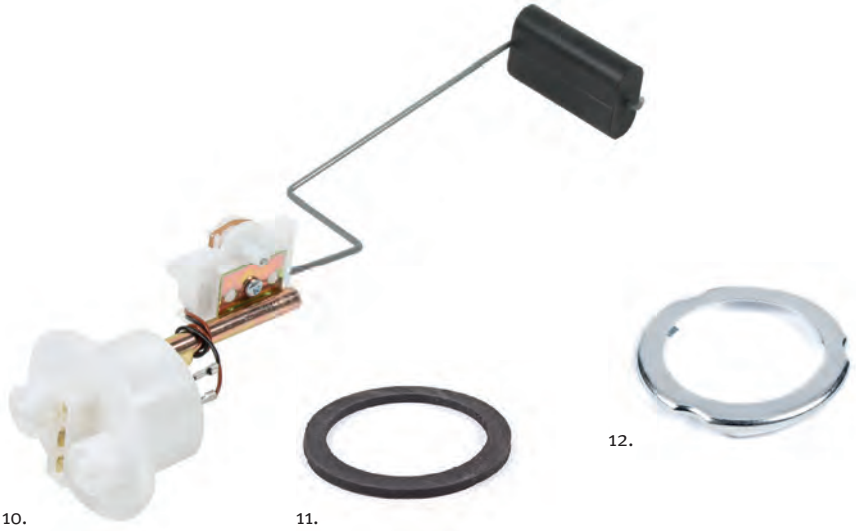

10.

11.

12.

16. WAGNER ADDITIVE BACTOFIN

fuel stabilizer, specially for fuels with Bio-Ethanol (E10). Dosage: 1:1000

- 100 ml. Part no. 494084
- 300 ml. Part no. 494085
- 1 litre. Part no. 494086



16.

Modern fuels attack the metal parts of the fuel supply systems. This problem applies especially to older vehicles, because in modern cars, for good reasons, more and more plastic tanks are used. The second problem relates to biogenic fuels and mixed fuels. This problem applies to owners of all ages of cars and modern cars too. In modern fuels bacteria grow in unprecedented quantities. This produces a lot of dirt, especially when the vehicle is not in regular use. The pipes gradually get blocked and the tank becomes contaminated with dirt. Rather than the drastic measure of replacing the entire fuel supply system, regular use of Bactofin will reduce the problem considerably. For vehicles which normally operate with lead-replacement or top oil, using Bactofin is just as easy and will give owners peace of mind. Bactofin also prevents any corrosion of the fuel system. Rust is completely inhibited!

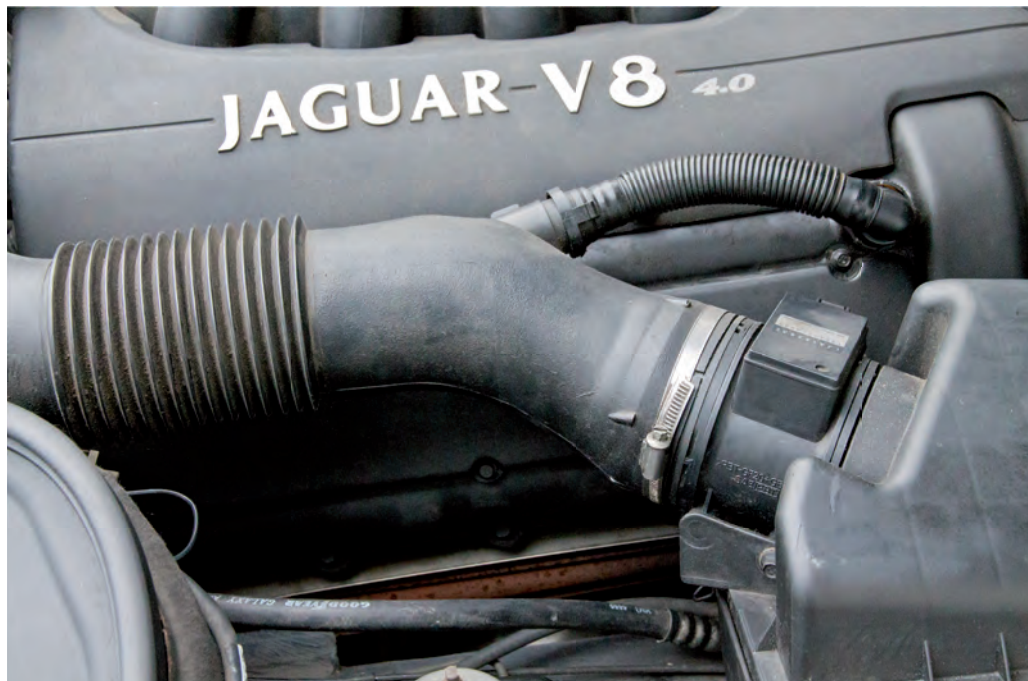

1. UPPER WISHBONE

comes without ball joint and bushes

X308 3.2 and 4.0 from VIN...812317 to F59525

Qty. required: 2 Part no. 423007



1.

2. BALL JOINT

upper wishbone

X308 3.2 and 4.0 from VIN...812317 to F59525

Qty. required: 2 Part no. 283986



2.

3. BUSH

original Jaguar - upper wishbone

X308 3.2 and 4.0 von VIN...812317 bis F59525

Qty. required: 4 Part no. 499139



3.

reproduction - upper wishbone

X308 3.2 and 4.0 from VIN...812317 to F59525

Qty. required: 4 Part no. 248604



4.

5.

4. BOLT

upper wishbone to front subframe

X308 3.2 and 4.0 from VIN...812317 to F59525

Qty. required: 2 Part no. 434203

5. TAPTITE NUT

ball joint an wishbone bolt

X308 3.2 and 4.0 from VIN...812317 to F59525

Qty. required: 4 Part no. 273342

6. REAR LOWER WISHBONE

with ball joint and bushes assembly

X308 3.2 and 4.0 from VIN...812317 to F59525

LH. Part no. 356297

RH. Part no. 356300



6.

7. LOWER FRONT WISHBONE

with bush assembly

X308 3.2 and 4.0 from VIN...812317 to F59525

LH. Part no. 434181

RH. Part no. 434175



7.

Please note

Please note: the front wishbones 434175 and 434181 must be replaced in sets



1. SHOCK ABSORBER, WISHBONES AND BALL JOINTS

8. BALL JOINT

rear lower wishbone

X308 3.2 and 4.0 from VIN...812317 to F59525

Qty. required: 2 Part no. 356329



8.

9. BUSH

front and rear lower wishbone

X308 3.2 and 4.0 von VIN...812317 bis F59525

Qty. required: 4 Part no. 355125



9.

Please note

Please note: the wishbone bushes must be replaced in sets



10. ADJUSTING BOLT

lower wishbone to front subframe

X308 3.2 and 4.0 from VIN...812317 to F59525

Qty. required: 2 Part no. 424717



10.



11.

11. TAPTITE NUT

ball joint an wishbone bolt

X308 3.2 and 4.0 from VIN...812317 to F59525

Qty. required: 4 Part no. 273342

12. HUB CARRIER

including larger 80 mm wheel bearing and anti roll bar link

X308 3.2 and 4.0 from VIN...812317 to 853935

LH. Part no. 422555

RH. Part no. 422556

X308 3.2 and 4.0 except ,R' performance options (Brembo brakes) from VIN...853936 to F59525

LH. Part no. 434205

RH. Part no. 434204

X308 3.2 and 4.0 with ,R' performance options (Brembo brakes) from VIN...853936 to F39525

LH. Part no. 434691

RH. Part no. 434689

X308 3.2 and 4.0 with ,R' performance options (Brembo brakes) from VIN...F39526 to F59525

LH. Part no. 434690

RH. Part no. 434692



12.

1. SHOCK ABSORBER, WISHBONES AND BALL JOINTS

13. WHEEL BEARING

with 76 mm outer diameter

X308 3.2 and 4.0 from VIN...812317 to 853935
Qty. required: 2 Part no. 283990

with 80 mm outer diameter

X308 3.2 and 4.0 from VIN...853936 to F59525
Qty. required: 2 Part no. 356295

14. CIRCLIP

for wheel bearing with 76 mm outer diameter

X308 3.2 and 4.0 from VIN...812317 to 853935
Qty. required: 2 Part no. 487802

for wheel bearing with 80 mm outer diameter

X308 3.2 and 4.0 from VIN...853936 to F59525
Qty. required: 2 Part no. 487803

15. LOCK PLATE

for wheel bearing

X308 3.2 and 4.0 from VIN...812317 to F59525
Qty. required: 2 Part no. 433299

16. TIMING ROTOR

ABS Sensor

X308 3.2 and 4.0 from VIN...812317 to F59525
Qty. required: 2 Part no. 283992



13.



14.



15.

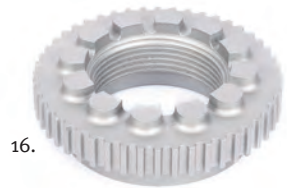

16.

17. WHEEL STUD

X308 3.2 and 4.0 from VIN...812317 to F59525
Qty. required: 20. Part no. 281257



17.

18. SHOCK ABSORBER

X308 3.2 and 4.0 with comfort suspension except adaptive control damping (C.A.T.S) from VIN...812317 to F59525
Qty. required: 2 Part no. 356336

X308 3.2 and 4.0 with sport suspension except adaptive control damping (C.A.T.S) from VIN...812317 to F59525
Qty. required: 2 Part no. 356335

X308 3.2 and 4.0 with comfort suspension and adaptive control damping (C.A.T.S) from VIN...812317 to F59525
Qty. required: 2 Part no. 434527

X308 3.2 and 4.0 with sport suspension and adaptive control damping (C.A.T.S) from VIN...812317 to F59525
Qty. required: 2 Part no. 434529



18.



1. SHOCK ABSORBER, WISHBONES AND BALL JOINTS

19. BUSH

shock absorber lower

X308 3.2 and 4.0 from VIN...812317 to F59525

Qty. required: 2 Part no. 355123

20. BOLT

shock absorber lower

X308 3.2 and 4.0 from VIN...812317 to F59525

Qty. required: 2 Part no. 417478

21. NYLOC NUT

shock absorber lower

X308 3.2 and 4.0 from VIN...812317 to F59525

Qty. required: 2 Part no. 273341

22. SPRING AND DAMPER MOUNTING

X308 3.2 and 4.0 except models with adaptive control damping (C.A.T.S) from VIN...812317 to F59525

LH. Part no. 434232

RH. Part no. 434228

X308 3.2 and 4.0 with adaptive control damping (C.A.T.S) from VIN...812317 to F59525

LH. Part no. 434234

RH. Part no. 434230

23. NYLOC NUT

shock absorber to mounting

X308 3.2 and 4.0 except models with adaptive control damping (C.A.T.S) from VIN...812317 to F59525

Qty. required: 2 Part no. 204134

X308 3.2 and 4.0 with adaptive control damping (C.A.T.S) from VIN...812317 to F59525

Qty. required: 2 Part no. 424779

24. PLAIN WASHER

shock absorber to mounting

X308 3.2 and 4.0 except models with adaptive control damping (C.A.T.S) from VIN...812317 to F59525

Qty. required: 2 Part no. 212195

25. ISOLATOR BUFFER

shock absorber

X308 3.2 and 4.0 from VIN...812317 to F59525

Qty. required: 2 Part no. 434535

26. DUST SEAL

shock absorber

X308 3.2 and 4.0 from VIN...812317 to F59525

Qty. required: 2 Part no. 434534

19.



21.



20.



22.



24.



26.



23.



25.



27. COIL SPRINGS

supplied in pairs

X308 3.2 and 4.0 with comfort suspension except Supercharged from VIN...812317 to F59525

Part no. 422104

X308 3.2 and 4.0 with sport suspension except Supercharged from VIN...812317 to F59525

Part no. 422105

X308 4.0 Supercharged with comfort suspension from VIN...812317 to F59525

Part no. 422328

X308 4.0 Supercharged with sport suspension from VIN...812317 to F59525

Part no. 422106



27.

1. SHOCK ABSORBER, WISHBONES AND BALL JOINTS

28. PACKING PIECE

below coil spring

X308 3.2 and 4.0 from VIN...812317 to F59525
Qty. required: 2 Part no. 434226



28.

29. RUBBER PAD

below coil spring

X308 3.2 and 4.0 from VIN...812317 to F59525
Qty. required: 2 Part no. 434225



29.

30. SPACING WASHER

coil spring

X308 3.2 and 4.0 from VIN...812317 to F59525
Qty. required: 2
height: 1.5 mm Part no. 433958
height: 4.5 mm Part no. 284416



30.

31. SPRING SEAT

coil spring

X308 3.2 and 4.0 from VIN...812317 to F59525
LH. Part no. 434249
RH. Part no. 434247



31.

32. ANTI ROLL BAR LINK

X308 3.2 and 4.0 from VIN...812317 to 853935
Qty. required: 2 Part no. 433310

X308 3.2 and 4.0 from VIN...853936 to F59525
Qty. required: 2 Part no. 434224



32.

33.

34.

33. BOLT

anti roll bar link to subframe

X308 3.2 and 4.0 from VIN...812317 to F59525
Qty. required: 2 Part no. 417480

34. NYLOC NUT

anti roll bar link to subframe

X308 3.2 and 4.0 from VIN...812317 to F59525
Qty. required: 2 Part no. 273341

1. SHOCK ABSORBER, WISHBONES AND BALL JOINTS

35. RUBBER BUSH

anti roll bar

**X308 3.2 and 4.0 with comfort suspension
from VIN...812317 to F59525**

Qty. required: 2 Part no. 434220



35.



36.

36. RUBBER BUSH

anti roll bar

**X308 3.2 and 4.0 with sport suspension
from VIN...812317 to F59525**

Qty. required: 2 Part no. 434223

37. SPECIAL GREASE

for bushes

5 gram. Part no. 312158



37.

38. BUSH

subframe - rear fixing

X308 3.2 and 4.0 from VIN...812317 to F59525

Qty. required: 2 Part no. 434245



38.

39. JAGUAR MOUNTING

subframe - front fixing

X308 3.2 and 4.0 from VIN...812317 to F59525

Qty. required: 2 Part no. 491581

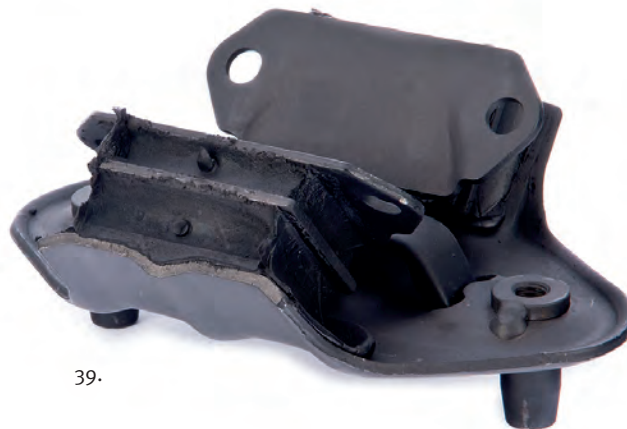

39.

40. MOUNTING

subframe - front fixing. Reproduction

X308 3.2 and 4.0 from VIN...812317 to F59525

Qty. required: 2 Part no. 284422



40.

1. MANIFOLD GASKET

exhaust manifold

X308 3.2 and 4.0 from VIN...812317 to F59525
to LH cylinder head
(B' bank) Part no. 435090
to RH cylinder head
(A' bank) Part no. 435089



1.

2. GASKET

catalytic converter to exhaust manifold

X308 3.2 and 4.0 from VIN...812317 to F59525
Qty. required: 2 Part no. 256258



2.

3. STUD

catalytic converter to exhaust manifold

X308 3.2 and 4.0 from VIN...812317 to F59525
Qty. required: 8 Part no. 424721



3.

4. TAPTITE NUT

catalytic converter to exhaust manifold

X308 3.2 and 4.0 from VIN...812317 to F59525
Qty. required: 8 Part no. 424773



4.



5.

5. LAMBDA OXYGEN SENSOR

heated, fitted in front of the catalytic converter

X308 3.2 and 4.0 with OBD II interface except Supercharged from VIN...812317 bis 853935, X308 4.0 Supercharged from VIN...812317 to 878717
Qty. required: 2 Part no. 282083

X308 3.2 and 4.0 except Supercharged from VIN...Fo6183 to F59252, X308 4.0 Supercharged from VIN...Fo0035 to F59525
Qty. required: 2 Part no. 431315

6. LAMBDA OXYGEN SENSOR

heated, fitted behind of the catalytic converter

X308 3.2 and 4.0 from VIN...812317 to F59525
Qty. required: 2 Part no. 431313



6.

1. EXHAUST SYSTEMS AND GASKETS

7. CENTRE SILENCER

without flexible coupling

X308 3.2 and 4.0 SWB models except Supercharged from VIN...812317 to F59525

Part no. 436493

X308 3.2 and 4.0 LWB models except Supercharged from VIN...812317 to F59525

Part no. 436494

X308 4.0 SWB Supercharged models from VIN...853936 to F59525

Part no. 436489

X308 4.0 LWB Supercharged models from VIN...853936 to F59525

Part no. 436490



7.

8.

9. FRONT SILENCER

with flexible coupling

X308 3.2 and 4.0 SWB models except Supercharged from VIN...812317 to F59525

Part no. 436495

X308 3.2 and 4.0 LWB models except Supercharged from VIN...812317 to F59525

Part no. 436496

X308 4.0 SWB Supercharged models from VIN...853936 to F59525

Part no. 436491

X308 4.0 LWB Supercharged models from VIN...853936 to F59525

Part no. 436492



9.

10.

10. GASKET

exhaust to catalytic converter

X308 3.2 and 4.0 with flexible coupling from VIN...812317 to F59525

Qty. required: 2Part no. 436188

11. TAPTITE NUT

exhaust to catalytic converter

X308 3.2 and 4.0 with flexible coupling from VIN...812317 to F59525

Qty. required: 4Part no. 370545



11.

1. EXHAUST SYSTEMS AND GASKETS

12. CENTRE SILENCER

**X308 3.2 and 4.0 except Supercharged
from VIN...812317 to F59525**

LH.Part no. 436500
RH.Part no. 436498

**X308 4.0 Supercharged
from VIN...812317 to F59525**

LH.Part no. 436185
RH.Part no. 436179

13. EXHAUST CLAMP

centre to front silencer

X308 3.2 and 4.0 from VIN...812317 to F59525

Qty. required: 2Part no. 208971

14. EXHAUST MOUNTING RUBBER

centre silencer

X308 3.2 and 4.0 from VIN...812317 to F59525

Qty. required: 2Part no. 389660



12.



14.



13.

15. REAR SILENCER

**X308 3.2 and 4.0 except Supercharged
from VIN...812317 to F59525**

LH.Part no. 436202
RH.Part no. 436194

**X308 4.0 Supercharged
from VIN...812317 to F59525**

LH.Part no. 436206
RH.Part no. 436198

16. EXHAUST CLAMP

rear to centre silencer

X308 3.2 and 4.0 from VIN...812317 to F59525

Qty. required: 2Part no. 208971

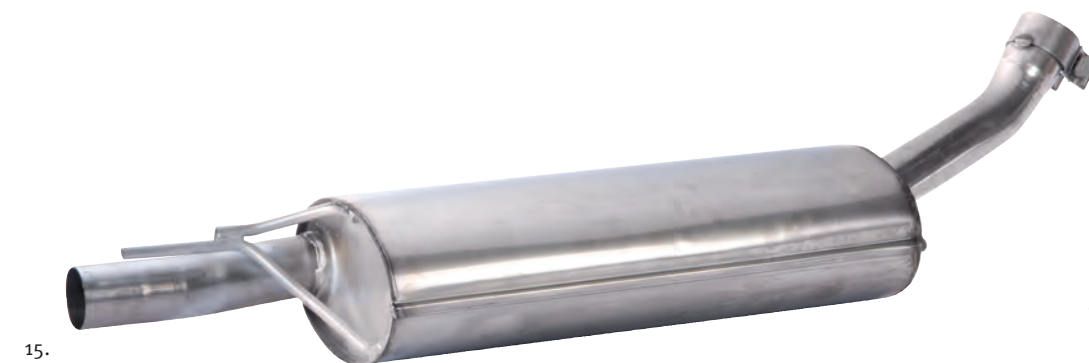

15.



16.

1. EXHAUST SYSTEMS AND GASKETS

17. EXHAUST MOUNTING

rear silencer

X308 3.2 and 4.0 from VIN...812317 to F59525

Qty. required: 2Part no. 207281



17.

18. EXHAUST BRACKET

rear mounting to underbody

X308 3.2 and 4.0 from VIN...812317 to F59525

Qty. required: 2Part no. 246445



18.

19. SCREW WITH WASHER

rear bracket to underbody

X308 3.2 and 4.0 from VIN...812317 to F59525

Qty. required: 4Part no. 424764



19.

20. FIXING BRACKET

rear silencer

X308 3.2 and 4.0 from VIN...812317 to F59525

L/HPart no. 286525

R/HPart no. 286524



20.

21. TAIL PIPE FINISHER

LH and RH, made from polished stainless steel

X308 3.2 and 4.0 except Supercharged from VIN...812317 to F59525

Qty. required: 2Part no. 329463



21.

22. TAIL PIPE FINISHER

LH and RH, made from polished stainless steel

X308 4.0 Supercharged from VIN...812317 to F59525

Qty. required: 2Part no. 436167



22.



1. TRACK ROD END

X308 3.2 and 4.0 from VIN...812317 to F59525
 Qty. required: 2 Part no. 17261



2. STEERING RACK GAITERS

supplied in pairs

Part no. 422359



3. HOSE CLIP

steering rack gaiter - 64 mm

Qty. required: 2 Part no. 422360

4. HOSE CLIP

steering rack gaiter - 13 mm

Qty. required: 2 Part no. 422361



5. POWER STEERING UNIT

exchange - LHD only

X308 3.2 and 4.0 except Sport models from VIN...812317 to 853935
 Part no. 485662

X308 3.2 and 4.0 Sport models from VIN...812317 to 853935
 Part no. 434290

X308 3.2 and 4.0 except Sport models from VIN...853936 to F59525
 Part no. 434615

X308 3.2 and 4.0 Sport models from VIN...853936 to F59525
 Part no. 485047



1. TRACK ROD ENDS, STEERING RACK, PUMP AND GAITERS

6. POWER STEERING UNIT

exchange - RHD only

**X308 3.2 and 4.0 except Sport models
from VIN...812317 to 853935**

Part no. 434267

**X308 3.2 and 4.0 except Sport models
from VIN...853936 to F59525**

Part no. 434612

**X308 3.2 and 4.0 Sport models
from VIN...853936 to F59525**

Part no. 434274

**X308 3.2 and 4.0 Sport models
from VIN...853936 to F59525**

Part no. 433767



6.

7. RUBBER BUSH

steering rack mounting - driver side

X308 3.2 and 4.0 from VIN...812317 to F59525

Part no. 434293

8. RUBBER BUSH

steering rack mounting - passenger side

X308 3.2 and 4.0 from VIN...812317 to F59525

Part no. 434294

9. STEERING PUMP

exchange

X308 3.2 and 4.0 from VIN...812317 to F59525

Part no. 433645



7.



8.



9.

10. HYDRAULIC RESERVOIR

power steering, with filler cap assembly

X308 3.2 and 4.0 from VIN...812317 to F59525
Part no. 284042



10.

11. HYDRAULIC PIPES

power steering rack - supplied in pairs

X308 3.2 and 4.0 from VIN...853936 to F59525
Part no. 423194



11.

12. STEERING COLUMN

lower - LHD only

X308 3.2 and 4.0 from VIN...812317 to F59525
Part no. 434642

lower - RHD only

X308 3.2 and 4.0 from VIN...812317 to F59525
Part no. 434638



12.

13. CASTROL AUTOMATIC GEARBOX OIL

Transmax Dex III for power steering - replaces TQ Dexron III

Transmax Dex III is a high quality mineral based automatic transmission fluid, recommended for most passenger cars where a product to the specification of GM Dexron III, Ford Mercon 94 or Allison C4 is recommended.

X308 3.2 and 4.0 from VIN...812317 to F59525
1 litre bottle
Part no. 217068



13.

capacity power steering unit: **1 litre**

1. SHOCK ABSORBER, WISHBONES AND COIL SPRINGS

1. SHOCK ABSORBER

X308 3.2 and 4.0 with sport suspension except adaptive control damping (C.A.T.S) and cars with ride level system from VIN..812317 to F59525
Qty. required: 2Part no. 356339

X308 3.2 and 4.0 with comfort suspension except adaptive control damping (C.A.T.S) and cars with ride level system from VIN..812317 to F59525
Qty. required: 2Part no. 356338

X308 3.2 and 4.0 with sport suspension and adaptive control damping (C.A.T.S) except cars with ride level system from VIN..812317 to F59525
Qty. required: 2Part no. 434260

X308 3.2 and 4.0 with comfort suspension and adaptive control damping (C.A.T.S) except cars with ride level system from VIN..812317 to F59525
Qty. required: 2Part no. 434259



1.

2. SHOCK ABSORBER

X308 3.2 and 4.0 with optional ride level system from VIN..812317 to F59525
Qty. required: 2Part no. 284451



2.

3. BUSH

shock absorber, lower mounting

X308 3.2 and 4.0 from VIN..812317 to F59525
Qty. required: 2Part no. 486964

4. BOLT

shock absorber, lower mounting

X308 3.2 and 4.0 from VIN..812317 to F59525
Qty. required: 2Part no. 281244

5. NUT

shock absorber, lower mounting

X308 3.2 and 4.0 from VIN..812317 to F59525
Qty. required: 2Part no. 280811

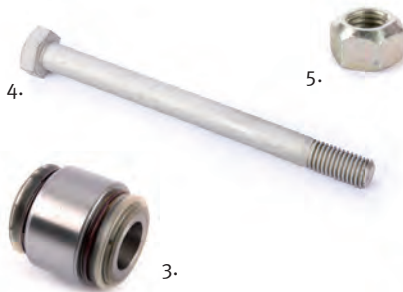

4.

5.

3.

6. BUSH

shock absorber, upper mounting, lower position - identify by 68 mm outer diameter

X308 3.2 and 4.0 from VIN..812317 to F59525
Qty. required: 2Part no. 247549

7. BUSH

shock absorber, upper mounting, upper position - identify by 50 mm outer diameter

X308 3.2 and 4.0 from VIN..812317 to F59525
Qty. required: 2Part no. 247548

8. NYLOC NUT

shock absorber to mounting

X308 3.2 and 4.0 from VIN..812317 to F59525
Qty. required: 2Part no. 424779



6.

7.

8.

9. COIL SPRINGS

supplied in pairs

X308 3.2 and 4.0 with sport suspension except Supercharged and cars with ride level system from VIN..812317 to F59525
Part no. 277613

X308 3.2 and 4.0 with comfort suspension except Supercharged and cars with ride level system from VIN..812317 to F59525
Part no. 277489

X308 4.0 Supercharged except cars with ride level system from VIN..812317 to F59525
Part no. 422295

X308 3.2 and 4.0 with ride level system from VIN..812317 to F59525
Part no. 277565



9.

KONI shock absorber see chapter 21.1.



1. SHOCK ABSORBER, WISHBONES AND COIL SPRINGS

10. SPRING AND DAMPER MOUNTING

X308 3.2 and 4.0 from VIN..812317 to F59525
Qty. required: 2Part no. 434258



10.

11. ISOLATOR BUFFER

coil spring, upper

X308 3.2 and 4.0 from VIN..812317 to F59525
Qty. required: 2Part no. 284356



11.

12. SPRING COLLAR

coil spring

X308 3.2 and 4.0 from VIN..812317 to F59525
Qty. required: 2Part no. 284355



12.

13. SPACING WASHER

coil spring

X308 3.2 and 4.0 from VIN..812317 to F59525
height: 2.90 - 3.40 mm
Qty. required: 2Part no. 247470



13.

height: 6.05 - 6.55 mm

Qty. required: 2Part no. 247471

14. PACKING

coil spring, lower

X308 3.2 and 4.0 from VIN..812317 to F59525
Qty. required: 2Part no. 250429



14.

15. BUMP STOP RUBBER

rear suspension

X308 3.2 and 4.0 with sport suspension except Supercharged from VIN..812317 to F59525
Qty. required: 2Part no. 284032

X308 3.2 and 4.0 with comfort suspension except Supercharged from VIN..812317 to F59525
Qty. required: 2Part no. 434262

X308 4.0 Supercharged from VIN..812317 to F59525
Qty. required: 2Part no. 284462



15.

16. FULCRUM PIN

trailing arm to pendulum

X308 3.2 and 4.0 from VIN..812317 to F59525
Qty. required: 2Part no. 284195



16.

17. NUT

trailing arm bolt

X308 3.2 and 4.0 from VIN..812317 to F59525
Qty. required: 2Part no. 273344



17.

18. BUSH

pendulum top mounting

X308 3.2 and 4.0 from VIN..812317 to F59525
Qty. required: 2Part no. 247209



18.



19.

19. BUSH

pendulum bottom mounting

X308 3.2 and 4.0 from VIN..812317 to F59525
Qty. required: 2Part no. 246809

20. STRUT

pendulum to differential, including mounting bushes
X308 3.2 and 4.0 with sport suspension from VIN..812317 to F59525 (fits also to cars with comfort suspension)
Part no. 433365

X308 3.2 and 4.0 with comfort suspension from VIN..812317 to F59525. Mabe replaced by strut 433365 if not available
Part no. 434261



20.

21. BUSH

pendulum strut - identify by amber colour

X308 3.2 and 4.0 with sport suspension from VIN..812317 to F59525
Qty. required: 4Part no. 433367

pendulum strut - identify by blue colour

X308 3.2 and 4.0 with comfort suspension from VIN..812317 to F59525
Qty. required: 4Part no. 433366



21.

1. SHOCK ABSORBER, WISHBONES AND COIL SPRINGS

22. BUSH
subframe

X308 3.2 and 4.0 with sport suspension from VIN...812317 to F59525
Qty. required: 2Part no. 433350

X308 3.2 and 4.0 with comfort suspension except Supercharged from VIN...812317 to F20645
Qty. required: 2Part no. 348943

X308 3.2 and 4.0 with comfort suspension except Supercharged from VIN...F20645 to F59525
Qty. required: 2Part no. 433350



22.

23. WHEEL BEARING KIT

X308 3.2 and 4.0 from VIN...812317 to F59525
Qty. required: 2Part no. 17382



23.

24. TIMING ROTOR
ABS sensor

X308 3.2 and 4.0 from VIN...812317 to F59525
Qty. required: 2Part no. 248435

25. TUBE COLLAR
drive shaft into hub

X308 3.2 and 4.0 from VIN...812317 to F59525
Qty. required: 2Part no. 248841

26. LOCKING NUT
drive shaft to hub

X308 3.2 and 4.0 from VIN...812317 to F59525
Qty. required: 2Part no. 248939

27. WHEEL STUD

X308 3.2 and 4.0 from VIN...812317 to F59525
Qty. required: 10Part no. 281257

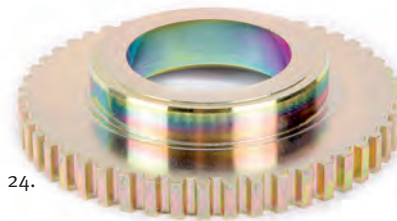

24.



25.



26.



27.

28. TAPERED ROLLER BEARING
hub carrier

X308 3.2 and 4.0 from VIN...812317 to F59525
Qty. required: 4Part no. 246800

29. SHIM
tapered roller bearing

X308 3.2 and 4.0 from VIN...812317 to F59525
3,905 mmPart no. 283769
3,955 mmPart no. 283774
4,005 mmPart no. 283775
4,055 mmPart no. 283776
4,105 mmPart no. 283777
4,155 mmPart no. 283778
4,205 mmPart no. 283779
4,255 mmPart no. 283780
4,305 mmPart no. 283781
4,355 mmPart no. 283770
4,405 mmPart no. 283771
4,455 mmPart no. 283772
5,505 mmPart no. 283773



28.



29.

30. FULCRUM PIN
hub carrier to trailing arm

X308 3.2 and 4.0 from VIN...812317 to F59525
Qty. required: 2Part no. 281250

31. LOCATION TUBE
hub carrier fulcrum pin

X308 3.2 and 4.0 from VIN...812317 to F59525
Qty. required: 2Part no. 247020

32. NUT
hub carrier fulcrum pin

X308 3.2 and 4.0 from VIN...812317 to F59525
Qty. required: 2Part no. 280811



30.



31.



32.

1. SHOCK ABSORBER, WISHBONES AND COIL SPRINGS

33. RUBBER BUSH

anti roll bar

X308 4.0 Supercharged and also 3.2 and 4.0 models with sport suspension from VIN...812317 to F59525

Qty. required: 2 Part no. 248491



33.

34. ANTI ROLL BAR LINK

X308 4.0 Supercharged and also 3.2 and 4.0 models with sport suspension from VIN...812317 to F59525

Qty. required: 2 Part no. 433968



34.

35. RUBBER BUSH

anti roll bar link

X308 4.0 Supercharged and also 3.2 and 4.0 models with sport suspension from VIN...812317 to F59525

Qty. required: 4 Part no. 284444

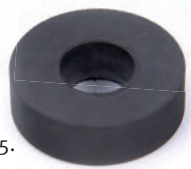

35.



36.

36. SPECIAL GREASE

for bushes

5 gram. Part no. 312158



2. DIFFERENTIAL

1. FLANGE

differential pinion, including oil seal

X308 3.2 and 4.0 from VIN...812317 to F59525
Part no. 422301



2. OIL SEAL

differential pinion - separately

X308 3.2 and 4.0 from VIN...812317 to F59525
Part no. 329091



3. BALL BEARING

differential pinion

X308 3.2 and 4.0 from VIN...812317 to F59525
Part no. 421970



4. TAPERED ROLLER BEARING

differential carrier (inner bearing)

X308 3.2 and 4.0 from VIN...812317 to F59525
Qty. required: 2Part no. 421972



5. BALL BEARING

differential shaft (outer bearing)

X308 3.2 and 4.0 from VIN...812317 to F59525
Qty. required: 2Part no. 421973

6. O' RING

outer differential bearing

X308 3.2 and 4.0 from VIN...812317 to F59525
Qty. required: 2Part no. 421963



7. CIRCLIP

outer differential bearing

X308 3.2 and 4.0 from VIN...812317 to F59525
Qty. required: 2Part no. 421965

8. BOLT

half shaft to differential housing

X308 3.2 and 4.0 from VIN...812317 to F59525
Qty. required: 8Part no. 279230



9. LOCK PLATE

half shaft

X308 3.2 and 4.0 from VIN...812317 to F59525
Qty. required: 4Part no. 421966



10. FLEXIBLE COUPLING

propshaft

X308 3.2 and 4.0 from VIN...812317 to F59525

Qty. required: 2 Part no. 249283



11. CASTROL GEAR OIL SAE 75W/140

X308 3.2 and 4.0 from VIN...812317 to F59525

1 litre bottle Part no. 472147

Castrol Syntrox Limited Slip 75W/140 (Formerly SAF-XJ 75W/140) is a fully synthetic SAE 75W/140 hypoid gear oil formulated for use in both conventional and limited slip differentials.

- Excellent shear stability
- Exceptional resistance to oxidation
- Particularly effective resistance to very strong loads
- Very good low temperature fluidity properties
- Affords increased drain intervals
- Helps prevent vibrations / noise occurring in the transmission

Specifications and Manufacturer Approvals: API GL-5, ZF TE-ML-05D, 12D, 16G, US claims - MIL-L-2105D, BMW approved (for limited slip)



capacity gear oil: 2 litre



1. FRONT BRAKES

1. BRAKE PADS

X308 3.2 and 4.0 except ,R' performance options (Brembo brakes) from VIN...812317 to F40672
 original JaguarPart no. 480041
 reproduction.Part no. 203692



2. BRAKE PADS

X308 3.2 and 4.0 except ,R' performance options (Brembo brakes) from VIN...F40673 to F59525
 original JaguarPart no. 480770

3. BRAKE PADS

X308 3.2 and 4.0 with ,R' performance options (Brembo brakes) from VIN...812317 to F59525
 original JaguarPart no. 434688
 reproduction.Part no. 491615



4. COPPER PASTE

Very good all round anti-seize and lubricant for high temperature applications. Avoids brake squeaking and sticking of the pads. Also protects exhaust and manifold screws and bolts against corrosion. Withstands extreme temperatures up to 1300 °C.
 100 gram tube Part no. 329423



5. SPRING CLIP

brake pads

X308 3.2 and 4.0 except ,R' performance options (Brembo brakes) from VIN...812317 to F59525
 Qty. required: 2Part no. 278819



6. FITTING KIT

brake pads

X308 3.2 and 4.0 with ,R' performance options (Brembo brakes) from VIN...812317 to F59525
 Part no. 422961



7. BRAKE DISCS

vented with 305 mm diameter

X308 3.2 and 4.0 except Supercharged and ,R' performance options (Brembo brakes) from VIN...812317 to 853935
 original Jaguar
 (supplied in pairs)Part no. 492124
 reproduction
 Qty. required: 2Part no. 278605

original



reproduction



8. BRAKE DISCS

vented with 325 mm diameter

**X308 3.2 and 4.0 except ,R' performance options
(Brembo brakes) from VIN...853936 to F59525**

original Jaguar

(supplied in pairs) Part no. 355972

reproduction

Qty. required: 2 Part no. 487030



8.

9. BRAKE DISCS

vented with 355 mm diameter and cross-drilled

**X308 3.2 and 4.0 with ,R' performance options
from VIN...812317 to F59525**

Original Jaguar with conical holes

(supplied in pairs) Part no. 422913

Reproduction without conical holes

Qty. required: 2 Part no. 487034



9.

10. DUST COVER

brake disc

**X308 3.2 and 4.0 except ,R' performance options
(Brembo brakes) from VIN...812317 to F59525**

LH Part no. 433302

RH. Part no. 433301

**X308 3.2 and 4.0 with ,R' performance options
(Brembo brakes) from VIN...812317 to F59525**

LH Part no. 434695

RH. Part no. 434694



10.

1. FRONT BRAKES

11. BRAKE CALIPER

new item, original Jaguar. Feature: brake system with 305 mm disc

X308 3.2 and 4.0 except Supercharged and ,R' performance options (Brembo brakes) from VIN...812317 to F59525, X308 4.0 Supercharged except ,R' performance options (Brembo brakes) from VIN...812317 to 853935

LH.Part no. 278281
RH.Part no. 278280

new item, original Jaguar. Feature: brake system with 325 mm disc

X308 4.0 Supercharged except ,R' performance options (Brembo brakes) from VIN...853936 to F59525

LH.Part no. 423076
RH.Part no. 423075

exchange. Feature: brake system with either 305 mm or 325 mm disc

X308 3.2 and 4.0 except Supercharged and ,R' performance options (Brembo brakes) from VIN...812317 to F59525, X308 4.0 Supercharged except ,R' performance options (Brembo brakes) from VIN...812317 to F59525

LH.Part no. 356272
RH.Part no. 356271



11.

12. JAGUAR BRAKE CALIPER

new item in grey. Feature: brake system with 355 mm disc

X308 3.2 and 4.0 with ,R' performance options (Brembo brakes) except XJR100 edition from VIN...812317 to F39525

LH.Part no. 422957
RH.Part no. 422956

X308 3.2 and 4.0 with ,R' performance options (Brembo brakes) except XJR100 edition from VIN...F39526 bis F59525

LH.Part no. 434686
RH.Part no. 434684

new item in silver. Feature: brake system with 355 mm disc

X308 4.0 XKR100 edition with ,R' performance options (Brembo brakes)

LH.Part no. 434687
RH.Part no. 434685



12.

13. PISTON

brake caliper

for brake system with 305 mm disc

X308 3.2 and 4.0 except Supercharged and ,R' performance options (Brembo brakes) from VIN...812317 to F59525, X308 4.0 Supercharged except ,R' performance options (Brembo brakes) from VIN...812317 to 853935

Qty. required: 2 Part no. 479994

for brake system with 325 mm disc

X308 4.0 Supercharged except ,R' performance options (Brembo brakes) from VIN...853936 to F59525

Qty. required: 2 Part no. 495552

14. SEAL KIT BRAKE CALIPER

for one brake caliper. Feature: brake system with 305 mm disc

X308 3.2 and 4.0 except Supercharged and ,R' performance options (Brembo brakes) from VIN...812317 to F59525, X308 4.0 Supercharged except ,R' performance options (Brembo brakes) from VIN...812317 to 853935

Qty. required: 2 Part no. 277364

for one brake caliper. Feature: brake system with 325 mm disc

X308 4.0 Supercharged except ,R' performance options (Brembo brakes) from VIN...853936 to F59525

Qty. required: 2 Part no. 433834



13.

14.

15. BOLT

brake caliper to hub carrier

All X308 3.2 and 4.0 from VIN...812317 to F39525, X308 3.2 and 4.0 except ,R' performance options (Brembo brakes) from VIN...F39526 to F59525

Qty. required: 4Part no. 281239



X308 3.2 and 4.0 with ,R' performance options (Brembo brakes) from VIN...F39526 to F59525

Qty. required: 4Part no. 416292

16. BLEED SCREW

brake caliper

X308 3.2 and 4.0 except ,R' performance options (Brembo brakes) from VIN...812317 to F59525

Qty. required: 2Part no. 433827

X308 3.2 and 4.0 with ,R' performance options (Brembo brakes) from VIN...853936 to F59525

Qty. required: 2Part no. 422960



17. DUST CAP

brake caliper bleed screw

X308 3.2 and 4.0 from VIN...812317 to F59525
Qty. required: 2Part no. 278816



18. PIN

brake caliper

X308 3.2 and 4.0 except ,R' performance options (Brembo brakes) from VIN...812317 to F59525

Qty. required: 2Part no. 278869



19. BUSH KIT

brake caliper pin

X308 3.2 and 4.0 except ,R' performance options (Brembo brakes) from VIN...812317 to F59525

Qty. required: 2Part no. 278817



20. BRAKE HOSE

X308 3.2 and 4.0 except ,R' performance options from VIN...812317 to F59525

Qty. required: 2Part no. 434362

X308 3.2 and 4.0 with ,R' performance options (Brembo brakes) from VIN...853936 to F59525

Qty. required: 2Part no. 434723



2. REAR BRAKES

1. BRAKE PADS

X308 3.2 and 4.0 except ,R' performance options (Brembo brakes) from VIN...812317 to F59525
 original JaguarPart no. 329166
 reproduction.Part no. 491813



2. BRAKE PADS

X308 3.2 and 4.0 with ,R' performance options (Brembo brakes) from VIN...853936 to F59525
 original JaguarPart no. 434707
 reproduction.Part no. 349034



3. COPPER PASTE

Very good all round anti-seize and lubricant for high temperature applications. Avoids brake squeaking and sticking of the pads. Also protects exhaust and manifold screws and bolts against corrosion. Withstands extreme temperatures up to 1300° C.
 100 gram tubePart no. 329423



4. SPRING CLIP

brake pads
X308 3.2 and 4.0 except ,R' performance options (Brembo brakes) from VIN...812317 to F59525
 Qty. required: 2 Part no. 277363



5. FITTING KIT

brake pads
X308 3.2 and 4.0 with ,R' performance options (Brembo brakes) from VIN...853936 to F59525
 Qty. required: 2 Part no. 422962



6. BRAKE DISCS

vented with 305 mm diameter
X308 3.2 and 4.0 except ,R' performance options (Brembo brakes) from VIN...812317 to F59525
 original Jaguar
 (supplied in pairs)Part no. 491651
 reproduction
 Qty. required: 2Part no. 276920



7. BRAKE DISCS

vented with 325 mm diameter and cross-drilled
X308 3.2 and 4.0 ,R' performance options (Brembo brakes) from VIN...853936 to F59525
 original Jaguar (supplied in pairs) Part no. 422915
 reproduction (supplied in pairs) Part no. 491620



8. BRAKE CALIPER

Feature: brake system with 305 mm disc

new item, original Jaguar

X308 3.2 and 4.0 except ,R' performance options (Brembo brakes) from VIN...812317 to F59525

LH.Part no. 421897

RH.Part no. 421896

exchange

X308 3.2 and 4.0 except ,R' performance options (Brembo brakes) from VIN...812317 to F59525

LH.Part no. 495565

RH.Part no. 495564



8.

9. JAGUAR BRAKE CALIPER

new item in grey. Feature: brake system with 325 mm disc

X308 3.2 and 4.0 with ,R' performance options (Brembo brakes) except XJR100 edition from VIN812317 to F39525

LH.Part no. 422959

RH.Part no. 422958

new item in grey. Feature: brake system with 325 mm disc

X308 3.2 and 4.0 with ,R' performance options (Brembo brakes) except XJR100 edition from VIN...F39526 to F59525

LH.Part no. 434705

RH.Part no. 434702

new item in silver. Feature: brake system with 325 mm disc

X308 4.0 XJR100 edition with ,R' performance options (Brembo brakes)

LH.Part no. 434706

RH.Part no. 434703



9.

10. DUST COVER

brake disc

X308 3.2 and 4.0 except ,R' performance options (Brembo brakes) from VIN...812317 to F59525

LH.Part no. 277609

RH.Part no. 277608

X308 3.2 and 4.0 with ,R' performance options (Brembo brakes) from VIN...853936 to F59525

LH.Part no. 422920

RH.Part no. 422919



10.

2. REAR BRAKES

11. PISTON

brake caliper. Applicable to: brake system with 305 mm disc

X308 3.2 and 4.0 except ,R' performance options (Brembo brakes) from VIN...812317 to F59525

Qty. required: 2 Part no. 495568



11.

12. SEAL KIT BRAKE CALIPER

for one brake caliper. Applicable to: brake system with 305 mm disc

X308 3.2 and 4.0 except ,R' performance options (Brembo brakes) from VIN...812317 to F59525

Qty. required: 2 Part no. 422705

12.



13. PIN

brake caliper

X308 3.2 and 4.0 except ,R' performance options (Brembo brakes) from VIN...812317 to F59525

Qty. required: 2 Part no. 278869

13.



14. BUSH KIT

brake caliper pin

X308 3.2 and 4.0 except ,R' performance options (Brembo brakes) from VIN...812317 to F59525

Qty. required: 2 Part no. 278817

14.



15. BLEED SCREW

brake caliper

X308 3.2 and 4.0 except ,R' performance options (Brembo brakes) from VIN...812317 to F59525

Qty. required: 2 Part no. 277361

15.



X308 3.2 and 4.0 with ,R' performance options (Brembo brakes) from VIN...853936 to F59525

Qty. required: 2 Best.-Nr 422960

16. DUST CAP

brake caliper bleed screw

X308 3.2 and 4.0 from VIN...812317 to F59525

Qty. required: 2 Part no. 278816

16.



17.



17. BOLT

brake caliper to hub carrier

X308 3.2 and 4.0 except ,R' performance options (Brembo brakes) from VIN...812317 to F59525,

X308 3.2 and 4.0 with ,R' performance options (Brembo brakes) from VIN...853936 to F39525

Qty. required: 4 Part no. 281255



18. BRAKE HOSE

X308 3.2 and 4.0 except ,R' performance options (Brembo brakes) from VIN...812317 to F59525

Qty. required: 2 Part no. 284090

X308 3.2 and 4.0 with ,R' performance options (Brembo brakes) from VIN...853936 to F59525

Qty. required: 2 Part no. 434725

18.



1. BRAKE SHOES

handbrake

X308 3.2 and 4.0 from VIN...812317 to F59525
Part no. 278283



2. RETURN SPRING

handbrake brake shoes, lower

X308 3.2 and 4.0 from VIN...812317 to F59525
Qty. required: 2 Part no. 278825

1.

3. RETURN SPRING

handbrake brake shoes, upper

X308 3.2 and 4.0 from VIN...812317 to F59525
Qty. required: 2 Part no. 278826



4. REBUILT KIT

handbrake mechanism - complete car set

X308 3.2 and 4.0 from VIN...812317 to F59525
Part no. 278871



5. BRAKE MASTER CYLINDER

3 hole fixing

X308 3.2 and 4.0 from VIN...812317 to F59525
Part no. 42197

4 hole fixing

X308 3.2 and 4.0 from VIN...812317 to F59525
Part no. 422820



6. FILLER CAP

brake master cylinder

X308 3.2 and 4.0 from VIN...812317 to F59525
Part no. 422858



3. HAND BRAKE, BRAKE HYDRAULICS AND WHEEL SPEED SENSORS

7. CASTROL BRAKE FLUID

X308 3.2 and 4.0 from VIN...812317 to F59525

React Performance DOT 4

1 litre bottlePart no. 472095

Castrol React Performance DOT 4 is a high boiling point polyglycol type brake fluid designed to provide superior braking performance in a variety of vehicles, especially those that operate at higher temperatures or under increased loads. The product has been formulated to give outstanding system protection against corrosion and high temperature vapour lock.

Castrol React Performance DOT 4 is suitable for use in all brake fluid systems in cars, motorcycles and light commercial vehicles requiring either a DOT 3, DOT 4 or Super DOT 4 product (excluding where a mineral oil based fluid is specified). Castrol React Performance DOT 4 can be used with either disc or drum brakes, including modern vehicles fitted with ABS systems. The product is also suitable for use in hydraulic clutch systems.

Product features and benefits

FMVSS 116 DOT 3 / DOT 4

SAE J 1703

ISO 4925

JIS K 2233



7.

8. SENSOR

wheel speed - anti lock braking system

X308 3.2 and 4.0 from VIN...812317 to F59525

Qty. required: 4 Part no. 282090



8.



9.

9. TIMING ROTOR

front ABS sensor

X308 3.2 and 4.0 from VIN...812317 to F59525

Qty. required: 2Part no. 283992



10.

10. TIMING ROTOR

rear ABS sensor

X308 3.2 and 4.0 from VIN...812317 to F59525

Qty. required: 2 Part no. 248435

11. PULLER

for ABS timing rotor

X308 3.2 and 4.0 from VIN...812317 to F59525

Part no. 220585



11.

12. HANDBRAKE CABLE

front - length: 62 cm

X308 3.2 and 4.0 SWB models
 from VIN...812317 to F59525
 Part no. 434558

front - length: 74 cm

X308 3.2 and 4.0 LWB models
 from VIN...812317 to F59525
 Part no. 434559



12.

13. HANDBRAKE CABLE

rear

X308 3.2 and 4.0 from VIN...812317 to F59525
 LH.Part no. 284425
 RH.Part no. 284424



13.

14. CONNECTOR

handbrake cable

X308 3.2 and 4.0 from VIN...812317 to F59525
 Part no. 247372



14.

3. HAND BRAKE, BRAKE HYDRAULICS AND WHEEL SPEED SENSORS

15. SWITCH

handbrake warning light

X308 3.2 and 4.0
 from VIN...812317 to F59525 (LHD models only)
 Part no. 429187

X308 3.2 and 4.0
 from VIN...812317 to F59525 (RHD models only)
 Part no. 429186



15.



16.

16. BRAKE LIGHT SWITCH

X308 3.2 and 4.0 from VIN...812317 to F59525
 Part no. 429185

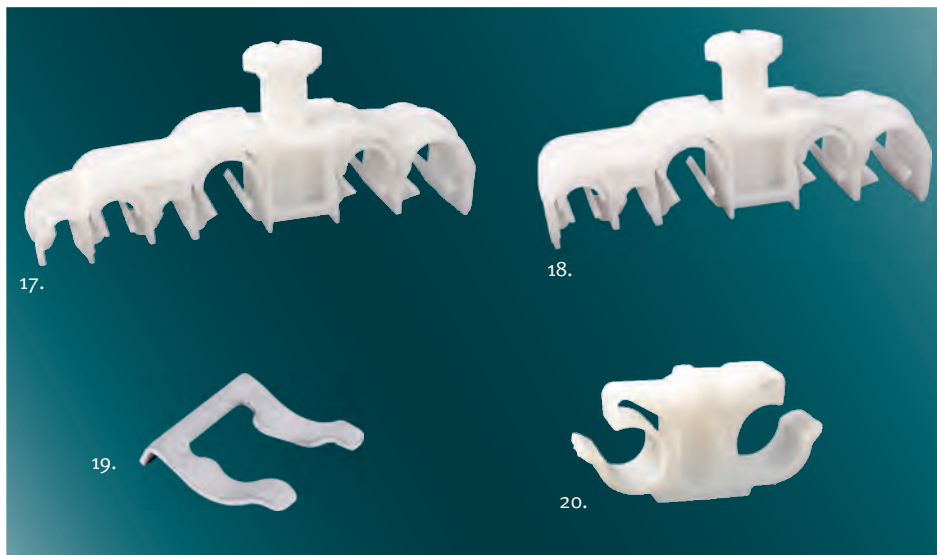

17.

18.

19.

20.

17. RETAINING CLIP

brake pipe

X308 3.2 and 4.0 from VIN...812317 to F59525
 Part no. 257426

18. RETAINING CLIP

brake pipe

X308 3.2 and 4.0 from VIN...812317 to F59525
 Qty. required: 6Part no. 286488

19. RETAINING CLIP

brake pipe

X308 3.2 and 4.0 from VIN...812317 to F59525
 Qty. required: 3Part no. 281488

20. RETAINING CLIP

rear brake hose

X308 3.2 and 4.0 from VIN...812317 to F59525
 Qty. required: 2Part no. 219699

21. PEDAL RUBBER

brake pedal

X308 3.2 and 4.0 from VIN...812317 to F59525
 Part no. 434040



21.



1. HUB CAP

less logo, colour: silver

X308 3.2 and 4.0 from VIN...812317 to F59525
Qty. required: 4 Part no. 249949



1.

2. BADGE

for hub cap - green with silver ,Jaguar' head

X308 3.2 and 4.0 from VIN...812317 to F59525
Qty. required: 4 Part no. 284745



2.

3. BADGE

for hub cap - black with gold ,Jaguar' head

X308 3.2 and 4.0 from VIN...812317 to F59525
Qty. required: 4 Part no. 284751



3.

4. BADGE

for hub cap - black with silver ,Jaguar' head

X308 3.2 and 4.0 from VIN...812317 to F59525
Qty. required: 4 Part no. 284752



4.

5. BADGE

for hub cap - red with silver ,Jaguar' head

X308 3.2 and 4.0 from VIN...812317 to F59525
Qty. required: 4 Part no. 284750



5.

6. BADGE

for hub cap - oyster with silver ,Jaguar' head

X308 3.2 and 4.0 with ,R' performance options (Brembo brakes) from VIN...853936 to F59525
Qty. required: 4 Part no. 434787



6.

7. WHEEL NUT

closed end variant with 33 mm total height

X308 3.2 and 4.0 from VIN...812317 to F59525
Qty. required: 20 Part no. 250360



7.

8. WHEEL NUT

closed end variant with 52 mm total height

X308 3.2 and 4.0 from VIN...812317 to F59525
Qty. required: 20 Part no. 250361



8.

9. WHEEL NUT

open end variant with 28 mm total height

X308 3.2 and 4.0 from VIN...812317 to F59525
Qty. required: 20 Part no. 284245



9.

Wheel lock nuts

supplied in sets of 4. Made from steel with triple nickel plating and chrome finishing. Provides effective security for your alloy wheels, with multiple key combinations. Recognised by some insurance companies, therefore lower insurance rating may be available

10. WHEEL LOCK NUTS

for wheel nuts with 33 mm total height

X308 3.2 and 4.0 from VIN...812317 to F59525
Part no. 495587

for wheel nuts with 52 mm total height

X308 3.2 and 4.0 from VIN...812317 to F59525
Part no. 495588



10.

11. CAP

for wheel lock nuts

X308 3.2 and 4.0 from VIN...812317 to F59525
Qty. required: 4Part no. 284785



11.

12. SPECIAL SPANNER

to remove wheel lock nut caps

X308 3.2 and 4.0 from VIN...812317 to F59525
Part no. 434084

Part of our wheel lock nuts 495587 and 495588 (ill. 10)



12.

13. WHEEL STUD

front and rear

X308 3.2 and 4.0 from VIN...812317 to F59525
Qty. required: 20.Part no. 281257



13.



14. WIRE WHEEL

fitment: bolt-on, rim size: 7.0j x 16", number of spokes: 70, rim inset: 22.50 mm, wheel weight: 14.00 kg, maximum wheel load: 625 kg. Including hub cap, wheel nuts and special key

X308 3.2 and 4.0 from VIN...812317 to F59525

Qty. required: 5

chromed Part no. 328678

stainless steel Part no. 481399

15. BADGE

for bolt-on wire wheel 328676 and 481399

X308 3.2 and 4.0 from VIN...812317 to F59525

Qty. required: 4 Part no. 495846

16. SPOKE BRUSH

solid round brush with wooden handle, length: 380 mm

Part no. 7339



14.



15.



16.

17. TUGA CHEMIE WHEEL CLEANER

Aluminium Devil Special®

1000 ml pump spray

with German labeling

Part no. 492912

with English labeling

Part no. 493118

with French labeling

Part no. 493119

The new Aluminium Devil Special® is an acid-free, modern highly efficient wheel rim cleaner. This cleaner easily removes persistent and extreme pollution of the light metal and steel rims, chromed rims and hubcaps/decorative trims. The new acid-free formula is an absolute self-cleaner. When used properly, rim surfaces and wheel bolts are not pitted. In addition, Aluminium Devil Special® strongly protects all metals. Aluminium Devil Special® is recommended for regular cleaning of the above mentioned rims.



17.



**Secured against theft by simply tightening a screw on the side of the caps.
Allen wrench included!**

see also chapter 21.4

18. TYRE VALVE CAPS

chromed with golden 'Jaguar leaping cat' on green surface. Supplied in sets of 4

Part no. 251195



19. TYRE VALVE CAPS

chromed with white 'Jaguar' head on green surface. Supplied in sets of 4

Part no. 446790



20. TYRE VALVE CAPS

chromed with Union Jack logo. Supplied in sets of 4

Part no. 478517



1. STARTER MOTOR AND ALTERNATOR

1. ALTERNATOR

new item base - output: 120 ampere, pulley: S7

X308 3.2 and 4.0 from VIN...812317 to F59525

new itemPart no. 495590

overhauled item

on exchange basisPart no. 429600



1.

2. DRIVE BELT

engine - multi groove type with 7 grooves

**X308 4.0 Supercharged
from VIN...853936 to F59525**

Part no. 434967

**X308 3.2 and 4.0 except Supercharged
from VIN...812317 to 878717**

Part no. 285954

**X308 3.2 and 4.0 except Supercharged
from VIN...F00035 to F59525**

Part no. 434967



2.



3. CONVERSION KIT

for engine drive belt

X308 3.2 and 4.0 from VIN...812317 to 878717

Improved version idler pulley and tension pulley
made from high quality steel

Part no. 286013



3.



4. STARTER MOTOR

power output: 1.2 kW, rotation: clock wise,
voltage: 12, drive: 9 teeth

X308 3.2 and 4.0 from VIN...812317 to F59525

new item on exchange basis . . .Part no. 496336

overhauled item

on exchange basisPart no. 374506

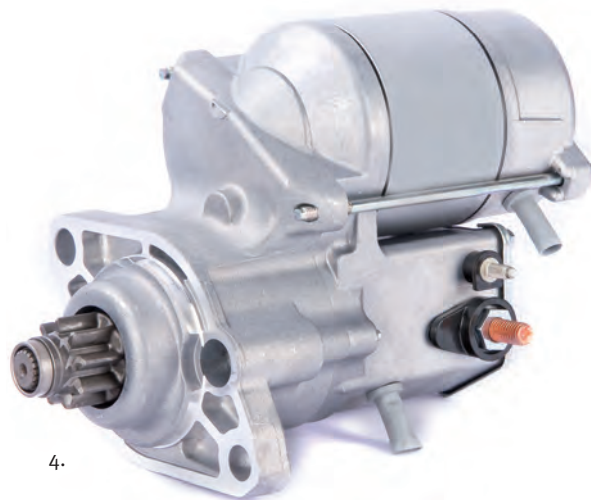

4.

1. NGK SPARK PLUG

X308 3.2 and 4.0 except Supercharged from VIN...812317 to 853935

Qty. required: 8 Part no. 435116

X308 3.2 and 4.0 except Supercharged from VIN...853936 to F59525

Qty. required: 8 Part no. 356293

X308 4.0 Supercharged from VIN...812317 to 878717

Qty. required: 8 Part no. 435120

X308 4.0 Supercharged from VIN...F00035 to F59525

Qty. required: 8 Part no. 356293



2. IGNITION MODULE

X308 3.2 and 4.0 from VIN...812317 to F59525

Qty. required: 2 Part no. 282073



3. RELAY

40 ampere open contact - multiple function

X308 3.2 and 4.0 from VIN...812317 to F59525

Qty. required: 2 Part no. 282256

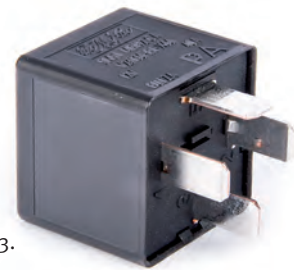

4. IGNITION COIL

on plug type with 2 pins

X308 3.2 and 4.0 from VIN...812317 to 853935

Qty. required: 8

original Jaguar Part no. 281634

reproduction. Part no. 495562



5. IGNITION COIL

on plug type with 2 pins

X308 3.2 and 4.0 from VIN...F00035 to F59525

Qty. required: 8 Part no. 374286



6. IGNITION COIL

on plug type with 4 pins

X308 3.2 and 4.0 from VIN...812317 to F59525

Qty. required: 8 Part no. 431300



3. HEATER UNIT AND WATER HOSES

1. HEATER MATRIX

X308 3.2 and 4.0 from VIN...812317 to F59525
Part no. 276960

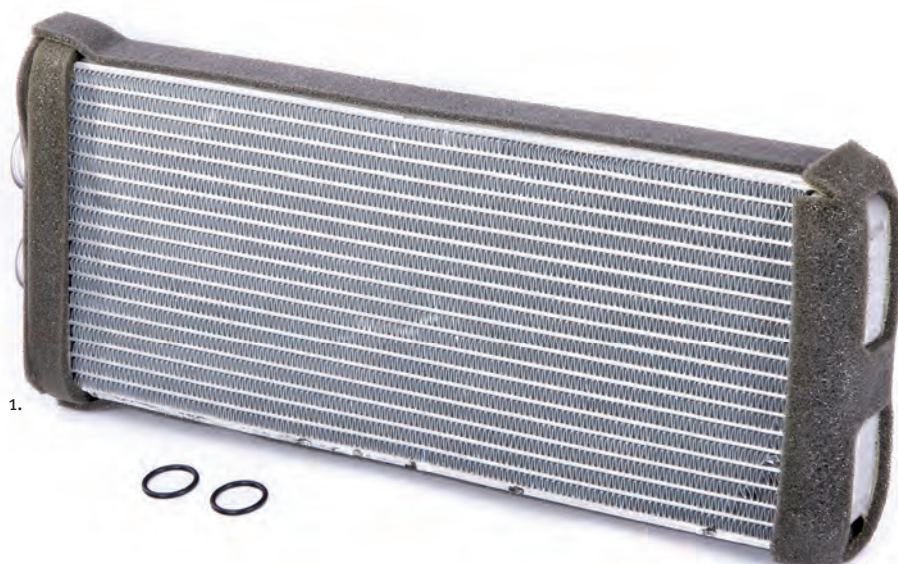

1.

2.

2. HEATER HOSE

heater feed

X308 3.2 and 4.0 except Supercharged
from VIN...812317 to F59525
Part no. 435126

X308 4.0 Supercharged
from VIN...812317 to F59525
Part no. 435242



3.

3. HEATER HOSE

heater return

X308 3.2 and 4.0 from VIN...812317 to F59525
Part no. 436399



4. HEATER HOSE

throttle body feed

X308 4.0 from engine no. 0108130000
Part no. 495850



4.

5. HEATER HOSE

throttle body return

X308 3.2 and 4.0 from VIN...812317 to 853935
Part no. 435136

X308 3.2 and 4.0 from VIN...853936 to F59525
Part no. 436402



5.

6. HEATER HOSE

EGR valve feed

X308 4.0 Supercharged
 from VIN...F00035 to F59525
 Part no. 436401



6.

7. HEATER HOSE

EGR valve return

X308 4.0 Supercharged
 from VIN...F00035 to F59525
 Part no. 436400



7.

8. HOSE CLIP

spring loaded type - for hoses from 23 to 27 mm diameter

X308 3.2 and 4.0 from VIN...812317 to F59525
 Qty. required: 6 Part no. 273407



8.

9. HOSE CLIP

spring loaded type - for hoses from 14 to 16 mm diameter

X308 3.2 and 4.0 from VIN...812317 to F59525
 Qty. required: 6 Part no. 273406



9.

10. HEATER VALVE

X308 3.2 and 4.0 from VIN...812317 to F59525
 Part no. 284817



10.

3. HEATER UNIT AND WATER HOSES

11. WATER PUMP

air conditioning

X308 3.2 and 4.0 from VIN...812317 to F59525

Part no. 434430



11.

12. HEATER HOSE

between engine and heater valve, including non return valve

X308 3.2 and 4.0 from VIN...812317 to F59525

Part no. 496361



12.

13. HEATER HOSE

between heater valve and heater matrix

X308 3.2 and 4.0 from VIN...812317 to F59525

Part no. 496365



13.

14. HEATER HOSE

between heater valve and air conditioning water pump, including non return valve

X308 3.2 and 4.0 from VIN...812317 to F59525

Part no. 496364



14.

15. HEATER HOSE

between air conditioning water pump and heater matrix

X308 3.2 and 4.0 from VIN...812317 to F59525
Part no. 434439



15.

16. HOSE CLIP

for hoses from 20 to 23 mm diameter

X308 3.2 and 4.0 from VIN...812317 to F59525
Qty. required: 6Part no. 273411



16.

17. PLIERS

for the removal and replacement of metal or plastic spring-loaded self-tightening hose clamps
Part no. 495853

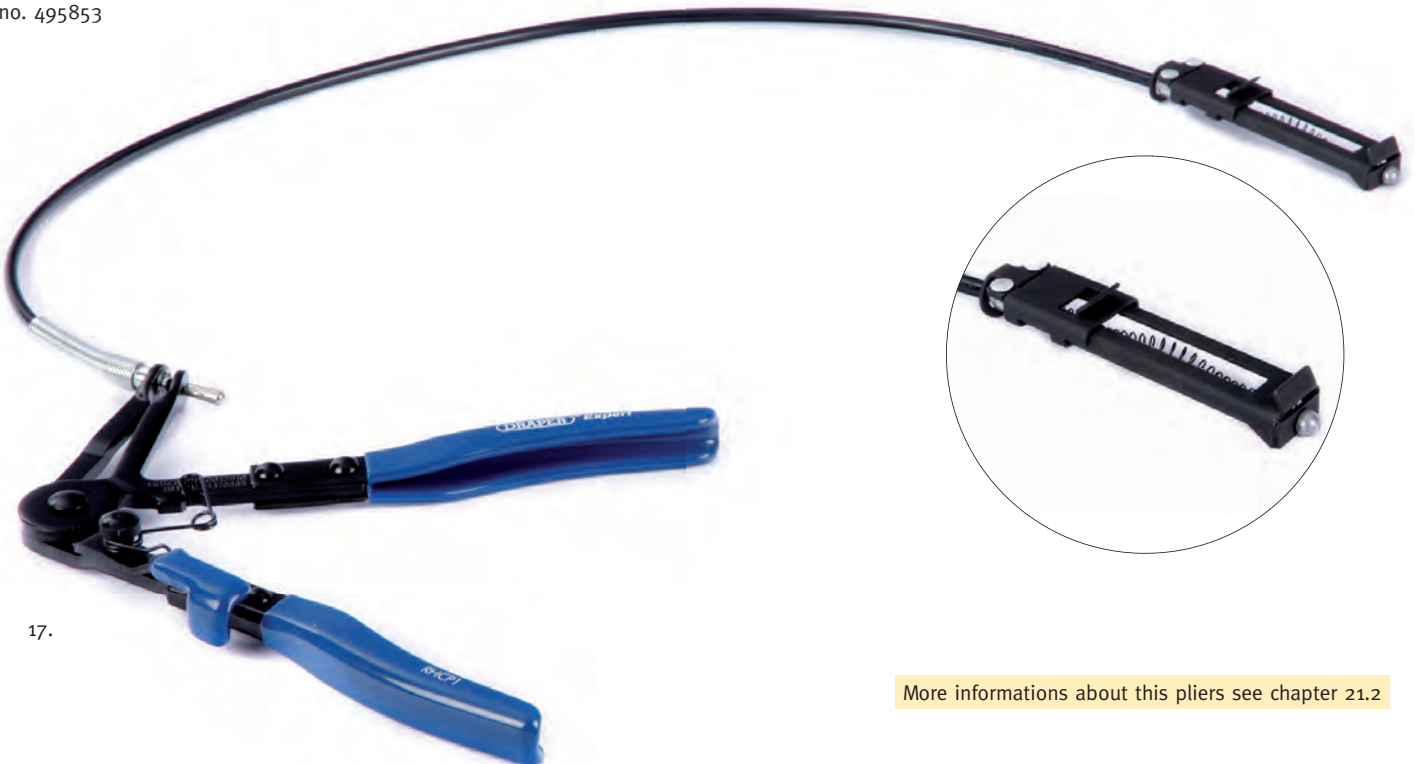

17.

More informations about this pliers see chapter 21.2

1. EVAPORATOR

air conditioning

X308 3.2 and 4.0 from VIN...812317 to F59525
Part no. 486914

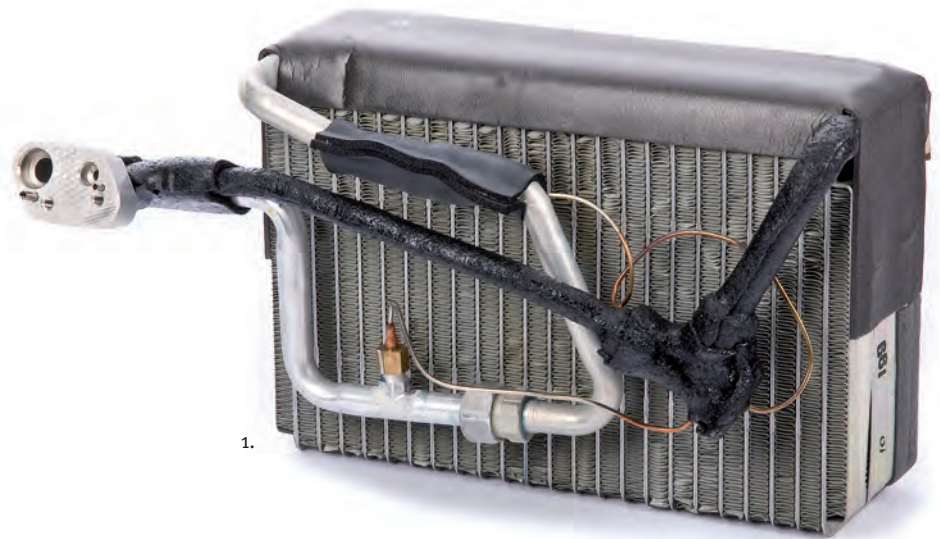

1.

2. AIR CONDITIONING COMPRESSOR

with 125 mm pulley and including top cover

X308 3.2 and 4.0 from VIN...812317 to F59525
Part no. 433210



2.

3. ,O' RING

air conditioning compressor - small

X308 3.2 and 4.0 from VIN...812317 to F59525
Part no. 281553



3.

4. ,O' RING

air conditioning compressor - large

X308 3.2 and 4.0 from VIN...812317 to F59525
Part no. 281555



4.

5. HYDRAULIC OIL

Denso ND8 - for air conditioning compressor

X308 3.2 and 4.0 from VIN...812317 to F59525
250 ml can.Part no. 277493



5.

6. CONDENSER

air conditioning

X308 3.2 and 4.0 from VIN...812317 to F59525

Part no. 355343

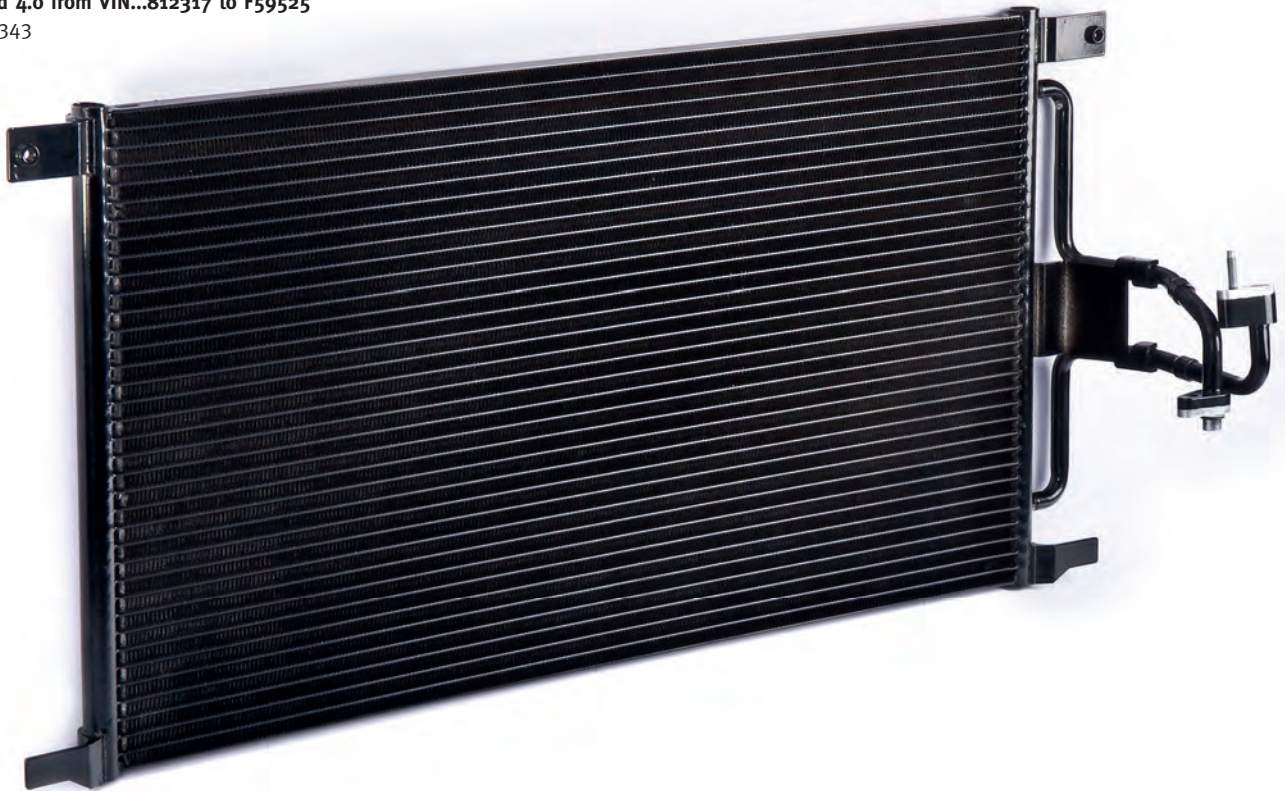

6.

7. ,O' RING

air conditioning pipe - size: 10 x 1.6 mm

X308 3.2 and 4.0 from VIN...812317 to F59525

Part no. 281568



7.

8. ,O' RING

air conditioning pipe - size: 14,3 x 1,2 mm

X308 3.2 and 4.0 from VIN...812317 to F59525

Part no. 281554



8.

9. ,O' RING

air conditioning pipe - size: 15.4 x 2 mm

X308 3.2 and 4.0 from VIN...812317 to F59525

Part no. 281553



9.

10. ,O' RING

air conditioning pipe - size: 17,2 x 1,3 mm

X308 3.2 and 4.0 from VIN...812317 to F59525

Part no. 281556



10.

11. ,O' RING

air conditioning pipe - size: 18 x 2 mm

X308 3.2 and 4.0 from VIN...812317 to F59525

Part no. 281555



11.

4. AIR CONDITIONING

12. RECEIVER DRIER

air condition

X308 3.2 and 4.0 from VIN...812317 to F59525
Part no. 336815

13. PRESSURE SWITCH

air conditioning

X308 3.2 and 4.0 from VIN...812317 to F59525
Part no. 426062

14. RUBBER BUSH

receiver drier mounting

X308 3.2 and 4.0 from VIN...812317 to F59525
Qty. required: 2Part no. 209402



12.



13.



14.

15. WATER PUMP

air conditioning

X308 3.2 and 4.0 from VIN...812317 to F59525
Part no. 434430



15.

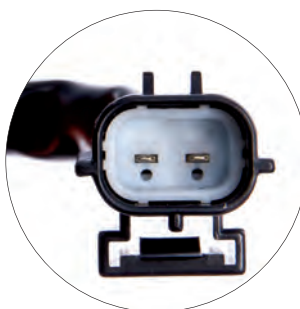

Online Shop!
www.Limora.com



1. HEADLAMPS

variant with automatic headlamp levelling.
Supplied in pairs

X308 3.2 and 4.0

from VIN...812317 to F59525 - LHD European models

LH.Part no. 430289

RH.Part no. 430286

X308 3.2 and 4.0

from VIN...812317 to F59525 - RHD models

LH.Part no. 348155

RH.Part no. 430284

**2. HEADLAMP**

variant without automatic headlamp levelling.
Supplied in pairs

X308 3.2 and 4.0

from VIN...812317 to F59525 - LHD European models

LH.Part no. 430301

RH.Part no. 430295

X308 3.2 and 4.0

from VIN...812317 to F59525 - RHD models

LH.Part no. 430299

RH.Part no. 430293



5. HEADLAMPS, SIDE LAMPS AND REAR LAMPS

3. HEADLAMP LENS

outer - dip beam

X308 3.2 and 4.0 from VIN...812317 to F59525 - LHD European models

Qty. required: 2Part no. 348821

X308 3.2 and 4.0 from VIN...812317 to F59525 - RHD models

Qty. required: 2Part no. 430303



4. HEADLAMP LENS

inner - main beam

X308 3.2 and 4.0 from VIN...812317 to F59525

Qty. required: 2Part no. 430302



5. ACTUATOR

headlamp levelling

X308 3.2 and 4.0 from VIN...812317 to F59525

Qty. required: 2Part no. 277357

6. JET

powerwash on headlamp

X308 3.2 and 4.0 with headlamp powerwash system from VIN...812317 to F59525

LH. Part no. 430433

RH. Part no. 430431

7. COVER

powerwash jet on headlamp

X308 3.2 and 4.0 with headlamp powerwash system from VIN...812317 to F59525

LH. Part no. 430437

RH. Part no. 430435



8. HALOGEN BULB

H7 with 55 watt - dip beam and main beam

X308 3.2 and 4.0 from VIN...812317 to F59525
Qty. required: 4Part no. 307245

9. BULB

with clear bulb surface - side lamps

X308 3.2 and 4.0 from VIN...812317 to F59525
Qty. required: 2Part no. 202445



10. LAMP

indicator in front bumper

X308 3.2 and 4.0 from VIN...812317 to F59525
LH.Part no. 430311
RH.Part no. 355126

11. BULB

with clear bulb surface - front indicator

X308 3.2 and 4.0 from VIN...812317 to F59525
Qty. required: 2Part no. 3495



12. REFLECTOR

on front bumper

X308 3.2 and 4.0 from VIN...812317 to F59525
LH.Part no. 430349
RH.Part no. 430347

on rear bumper

X308 3.2 and 4.0 from VIN...812317 to F59525
LH.Part no. 430353
RH.Part no. 430351

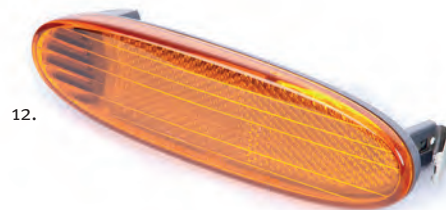

13. LAMP

repeater on front wing

X308 3.2 and 4.0 except USA, Canada and Mexico exports from VIN...812317 to F59525
Qty. required: 2Part no. 283241

14. BULB

with clear bulb surface - repeater

X308 3.2 and 4.0 except USA, Canada and Mexico exports from VIN...812317 to F59525
Qty. required: 2Part no. 202445



5. HEADLAMPS, SIDE LAMPS AND REAR LAMPS

15. FOG LAMP

in front bumper

X308 3.2 and 4.0 from VIN...812317 to F59525
Qty. required: 2Part no. 430363



15.

16. HALOGEN BULB

HB4 with 51 watt - fog lamp

X308 3.2 and 4.0 from VIN...812317 to F59525
Qty. required: 2Part no. 253015



16.

17. LAMP

rear, variant with chrome bezel - lens: red and clear

X308 3.2 and 4.0 von VIN...812317 bis F59525
LH.Part no. 355985
RH.Part no. 355984



17.

18. LAMP

rear, variant with red bezel - lens: red and clear

X308 3.2 and 4.0 von VIN...812317 bis F59525
LH.Part no. 355986
RH.Part no. 355987



18.

19. BULB

with clear bulb surface - stop and tail light

X308 3.2 and 4.0 from VIN...812317 to F59525
Qty. required: 2Part no. 7476



19.

20. BULB

with clear bulb surface - rear fog lamp and reverse lamp

X308 3.2 and 4.0 from VIN...812317 to F59525
Qty. required: 4Part no. 3495



20.

21. BULB

with amber bulb surface - rear indicator

X308 3.2 and 4.0 from VIN...812317 to F59525
Qty. required: 4Part no. 16107



21.

22. NUMBER PLATE LAMP

black plastic housing

X308 3.2 and 4.0 from VIN...812317 to F59525
Qty. required: 2Part no. 283263



22.

23. BULB

with clear bulb surface - number plate lamp

X308 3.2 and 4.0 from VIN...812317 to F59525
Qty. required: 2Part no. 2098



23.

1. WIPER BLADE

X308 3.2 and 4.0 from VIN...812317 to F59525
Qty. required: 1. Part no. 399701



2. RUBBER STRIP

for wiper blade

X308 3.2 and 4.0 from VIN...812317 to F59525
Part no. 407447



3. WIPER MOTOR

X308 3.2 and 4.0 from VIN...812317 to F59525
LHD models Part no. 409682
RHD models Part no. 409680



4. NUT

wiper arm to wiper motor

X308 3.2 and 4.0 from VIN...812317 to F59525
Part no. 279655

5. NON-RETURN VALVE

in wiper motor

X308 3.2 and 4.0 from VIN...812317 to F59525
Part no. 422552



6. WINDSCREEN WIPER, AND WIPER MOTOR

6. JET

windscreen washer - mounted to wiper arm

X308 3.2 and 4.0 from VIN...812317 to F59525
Part no. 409686



6.

7. WASHER PUMP

windscreen

X308 3.2 and 4.0 from VIN...812317 to F59525
Part no. 426041



7.

8. SEALING RUBBER

screenwash pump

X308 3.2 and 4.0 from VIN...812317 to F59525
Part no. 426042



8.

9. WASHER PUMP

headlamp powerwash - electric

X308 3.2 and 4.0 with headlamp powerwash system from VIN...812317 to F59525
Part no. 430424

10. SEALING RUBBER

headlamp powerwash pump

X308 3.2 and 4.0 with headlamp powerwash system from VIN...812317 to F59525
Part no. 430427



11.

11. JET

powerwash on LH headlamp

X308 3.2 and 4.0 with headlamp powerwash system from VIN...812317 to F59525
Part no. 430433

powerwash on RH headlamp

X308 3.2 and 4.0 with headlamp powerwash system from VIN...812317 to F59525
Part no. 430431

9.



10.



12. WASHER BOTTLE

windscreen and headlamp powerwash system

X308 3.2 and 4.0 with headlamp powerwash system from VIN...812317 to F59525

Part no. 430429

windscreen washer

X308 3.2 and 4.0 without headlamp powerwash system from VIN...812317 to F59525

Part no. 430428

13. FILLER NECK

with cap - windscreen washer bottle

X308 3.2 and 4.0 from VIN...812317 to F59525

Part no. 430425

14. FILLER CAP

windscreen washer bottle

X308 3.2 and 4.0 from VIN...812317 to F59525

Part no. 430426



14.



12.



13.



7. FUSES, RELAYS AND SWITCHES

1. RELAY

with 20 ampere, multiple function - air conditioning, mirror heater, manual adjust seat, fuel filler flap lock, door lock, etc...

X308 3.2 and 4.0 from VIN...812317 to F59525
Qty. required: 8Part no. 429020

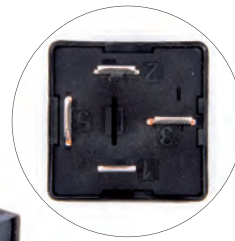
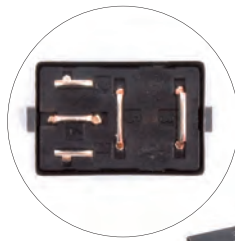

2. RELAY

with 40 ampere open contact - multiple function i.e. seat heater, powerwash, rear parking aid, air conditioning, ignition/engine, ignition/heelboard, fuel pump, etc...

X308 3.2 and 4.0 from VIN...812317 to F59525
Qty. required: 8Part no. 282256

3. STALK

indicator, dip beam and headlamp flash

X308 3.2 and 4.0 with automatic headlamp levelling from VIN...812317 to F59525
Part no. 430413

X308 3.2 and 4.0 without automatic headlamp levelling from VIN...812317 to F59525
Part no. 430414

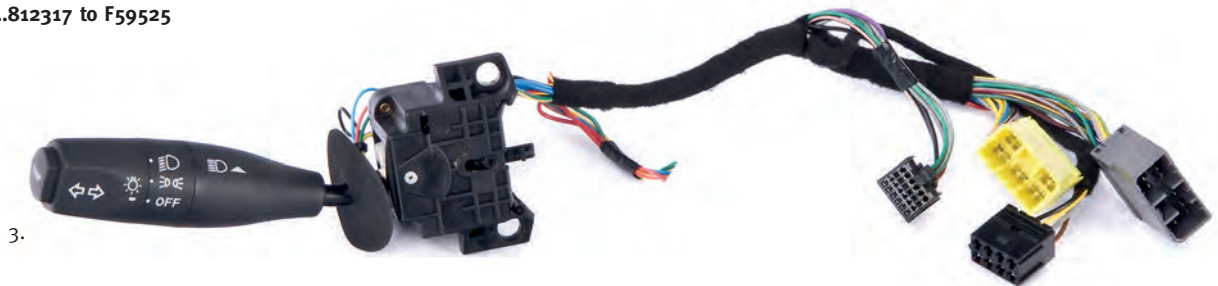

4. STALK

windscreen wipe and wash

X308 3.2 and 4.0 without rain sensing system from VIN...812317 to 878717
Part no. 430415

X308 3.2 and 4.0 without rain sensing system from VIN...F00035 to F59525
Part no. 282248

X308 3.2 and 4.0 with rain sensing system from VIN...F00035 to F59525
Part no. 432515

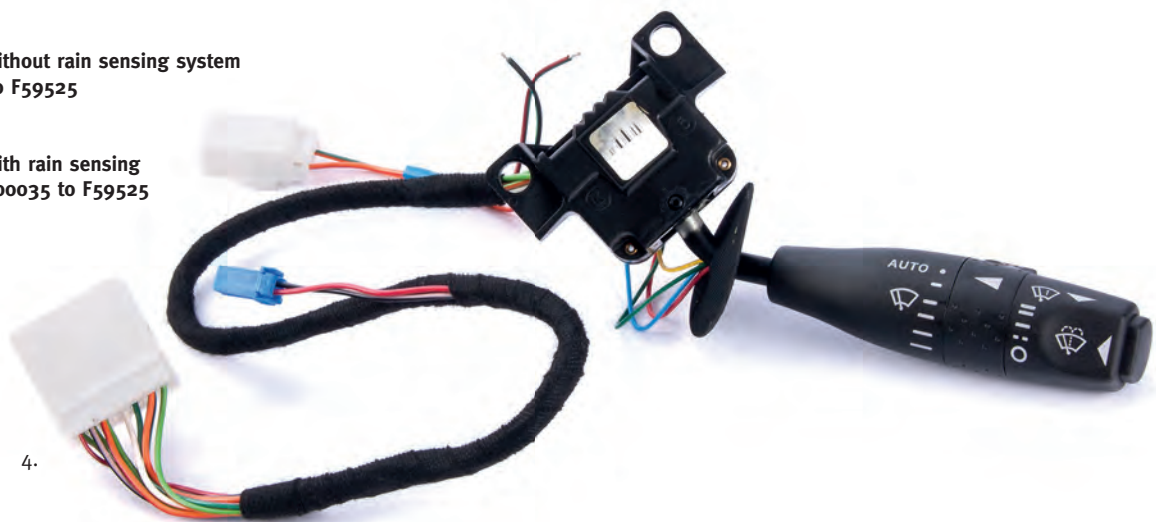

5. ELEMENT

front cigar lighter

X308 3.2 and 4.0 from VIN...812317 to F59525
Part no. 426590



6. ELEMENT

rear cigar lighter

X308 3.2 and 4.0 from VIN...812317 to F59525
Part no. 253251

7. HOUSING

front cigar lighter

X308 3.2 and 4.0 from VIN...812317 to F59525
Part no. 429938



8. HOUSING

rear cigar lighter

X308 3.2 and 4.0 from VIN...812317 to F59525
Part no. 282104



9. BULB

cigar lighter

X308 3.2 and 4.0 from VIN...812317 to F59525
Qty. required: 2Part no. 7474



10. MAGAZINE

for original Jaguar CD autocharger

X308 3.2 and 4.0 from VIN...812317 to F59525
Part no. 390815

11. BULB

with clear bulb surface - used on console switch module

X308 3.2 and 4.0 from VIN...812317 to F59525
Part no. 283265



12. BULB

with blue bulb surface - used on console switch module

X308 3.2 and 4.0 from VIN...812317 to F59525
Part no. 283266



Did you know... ? 

LCD stands for Liquid Crystal Display. These are not the self-lit displays using LEDs - light emitting diodes, which were popular up to the 80's in watches, calculators and also in car instruments. The activated segments of an LCD could represent numbers, or other symbols to provide a clear information display. The classic LCD display has now given way to LCD monitor and the TFT (Thin Film Transistor) display which now have a permanent place and are found in most centre consoles.

7. FUSES, RELAYS AND SWITCHES

13. BULB

festoon type with clear bulb surface - courtesy and interior lights

X308 3.2 and 4.0 from VIN...812317 to F59525
Qty. required: 2 Part no. 2098



14. BULB

capless base type with clear bulb surface - interior light

X308 3.2 and 4.0 from VIN...812317 to F59525
Qty. required: 2 Part no. 253313

15. BULB

with blue bulb surface and brown socket - used on air conditioning control panel

X308 3.2 and 4.0 from VIN...812317 to F59525
Qty. required: 2 Part no. 276977



16. BULB

with green bulb surface and black socket - used on air conditioning control panel

X308 3.2 and 4.0 from VIN...812317 to F59525
Qty. required: 2 Part no. 421955



17. BULB

with blue bulb surface and black socket - used on air conditioning control panel

X308 3.2 and 4.0 from VIN...812317 to F59525
Qty. required: 7 Part no. 421954



Fuses

18. FUSE

mega type

X308 3.2 and 4.0 from VIN...812317 to F59525
100 ampere - lettering: yellow
Part no. 433187

125 ampere - lettering: green
Part no. 433188

150 ampere - lettering: amber
Part no. 433189

175 ampere - lettering: white
Part no. 433190

200 ampere - lettering: blue
Part no. 433191

225 ampere - lettering: tan
Part no. 433192

250 ampere - lettering: pink
Part no. 433193

19. FUSE

standard blade type

X308 3.2 and 4.0 from VIN...812317 to F59525
3 ampere - colour: purple
Part no. 433177

5 ampere - colour: brown
Part no. 11680

10 ampere - colour: red
Part no. 322612

15 ampere - colour: blue
Part no. 298275

20 ampere - colour: yellow
Part no. 468337

25 ampere - colour: clear
Part no. 456137

30 ampere - colour: green
Part no. 296498

35 ampere - colour: green/blue
Part no. 433185

40 ampere - colour: amber
Part no. 496456

20. FUSES

packet with 42 standard blade type fuses. These fuses stop the guesswork during fault finding! When they burn out they light up! Content: 5, 10, 15, 20, 25 and 30 ampere fuses, 7 of each size plus a fuse remover

Part no. 321281



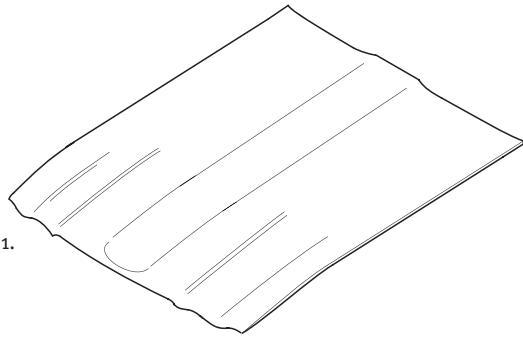

1.

1. BONNET

X308 3.2 and 4.0 from VIN...812317 to F59525
Part no. 277505

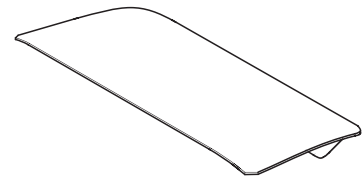

2.

2. BOOT LID

X308 3.2 and 4.0 from VIN...812317 to F59525
Part no. 220521

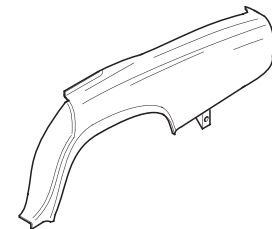
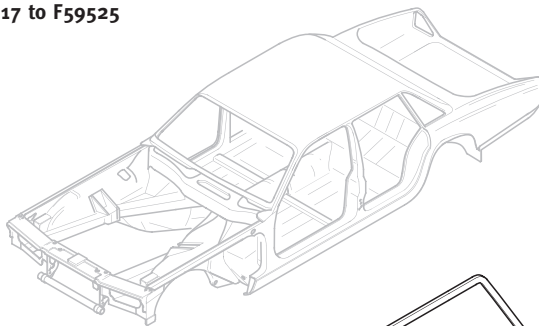

4.

4. SIDE PANEL

rear

X308 3.2 and 4.0 from VIN...812317 to F59525
LH.Part no. 396683
RH.Part no. 396724

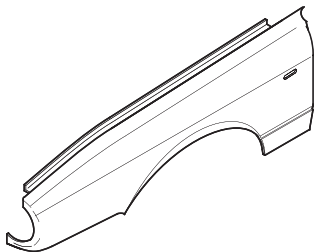

3.

3. WING

front

X308 3.2 and 4.0 from VIN...812317 to F59525
LH.Part no. 220472
RH.Part no. 220471

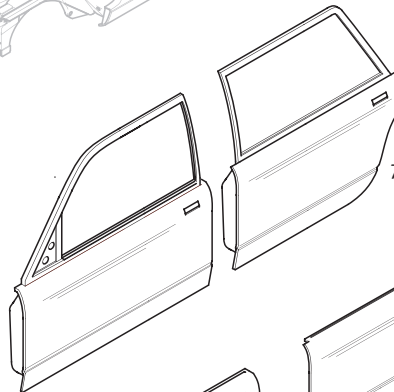

7.

5.

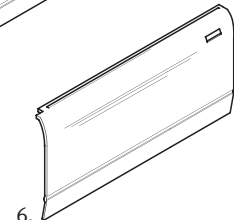

6.

5. DOOR

front

X308 3.2 and 4.0 from VIN...812317 to F59525
LH.Part no. 396719
RH.Part no. 396718

7. DOOR

rear

X308 3.2 and 4.0 LWB models from VIN...812317 to F59525
LH.Part no. 396892
RH.Part no. 396891

X308 3.2 and 4.0 SWB models from VIN...812317 to F59525
LH.Part no. 396721
RH.Part no. 396720

6. DOOR SKIN

front

X308 3.2 and 4.0 from VIN...812317 to F59525
LH.Part no. 396673
RH.Part no. 348073

8. DOOR SKIN

rear

X308 3.2 and 4.0 LWB models from VIN...812317 to F59525
LH.Part no. 396884
RH.Part no. 396881

X308 3.2 and 4.0 SWB models from VIN...812317 to F59525
LH.Part no. 396675
RH.Part no. 396674



1. WINGS, DOORS AND BONNETS

9. HAMMER

for shrinking. With 310 mm long hickory handle and 225g steel head with 38 mm diameter

Part no. 216524



10. SUCTION PAD

suction cup with 118 mm diameter. Can be used for body work or for carrying glass and more

Part no. 21503



11. BODY CONTOUR GAUGE

with stainless steel pins for quick and precise gauging of profiles. Comes with integrated metric and imperial rule. Max depth: 50 mm, max length: 150 mm

Part no. 13098



12. PANEL BEATER SAND BAG

for the manual forming of sheet metal. Made of genuine heavy duty leather, diameter: 330 mm, to be filled with sand

Part no. 394574



13. ADVANCE BOARD

240 x 270 mm, 360° rotatable. Contains: supporting base and tear-off blocks with 2 x 50 working surfaces

Part no. 14926



14. SEALING COMPOUND

for auto body work. This 1- compound sealant can be painted, stays hard-elastic and can be used from -35° up to + 70° C. Very durable and very good adhesion

310 ml tubePart no. 243825

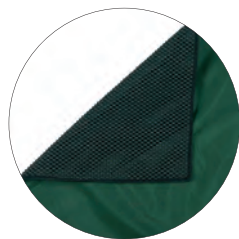

15.

15. WING COVER

green padded and emblazoned with the leaping cat. Size: 90 x 50 cm

Made from nylon, washable. Doesn't scratch paintwork because of supersoft anti-slip surface on underside. No magnets inside.

Part no. 487962



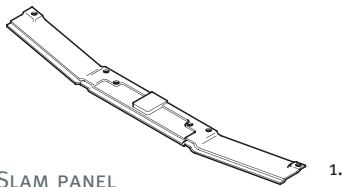

1. SLAM PANEL
bonnet

X308 3.2 and 4.0 from VIN...812317 to F59525
Part. no. 348115

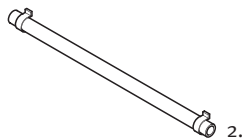
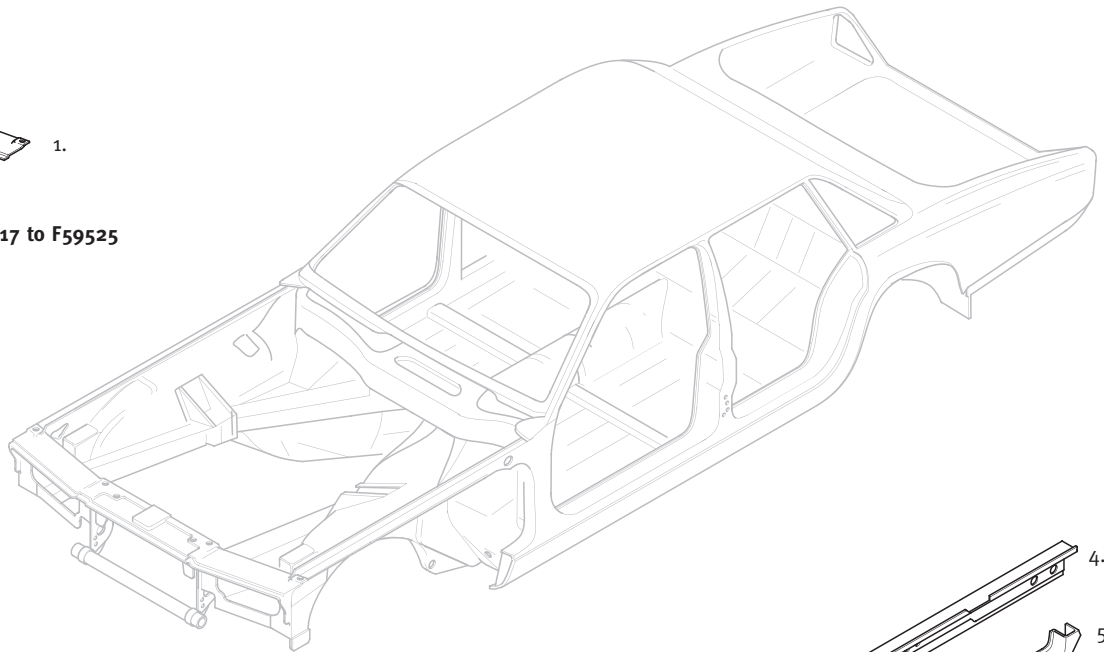

2. CROSS TUBE
front valance

X308 3.2 and 4.0 from VIN...812317 to F59525
Part. no. 220512

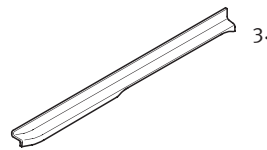

3. REINFORCEMENT
inner wing

X308 3.2 and 4.0 from VIN...812317 to F59525
LH.Part. no. 396708
RH.Part no. 396707

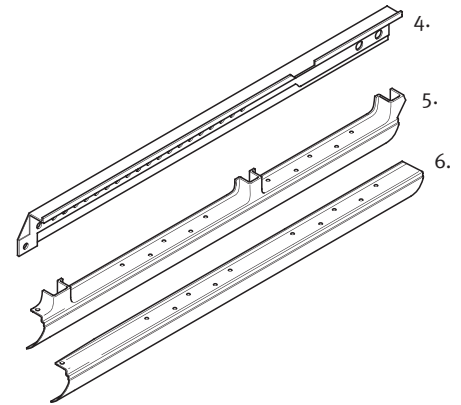

4. INNER SILL

X308 3.2 and 4.0 LWB models from VIN...812317 to F59525
LH. Part no. 396906
RH. Part no. 396905

X308 3.2 and 4.0 SWB models from VIN...812317 to F59525
LH. Part no. 396731
RH. Part no. 396730

5. OUTER SILL

X308 3.2 and 4.0 LWB models from VIN...812317 to F59525
LH. Part no. 421944
RH. Part no. 421943

X308 3.2 and 4.0 SWB models from VIN...812317 to F59525
LH. Part no. 421942
RH. Part no. 421941

6. REPAIR PANEL

outer sill - fits to RH and LH side
X308 3.2 and 4.0 from VIN...812317 to F59525
Qty. required: 2 Part no. 278082



3. INNER BODY REPAIR PANELS, FRONT SECTION

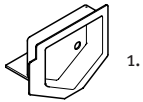

1. BUMPER BRACKET

front

X308 3.2 and 4.0 from VIN...812317 to F59525

LH. Part no. 220498

RH. Part no. 220497

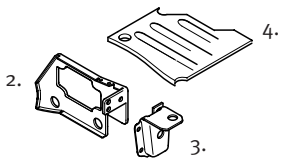
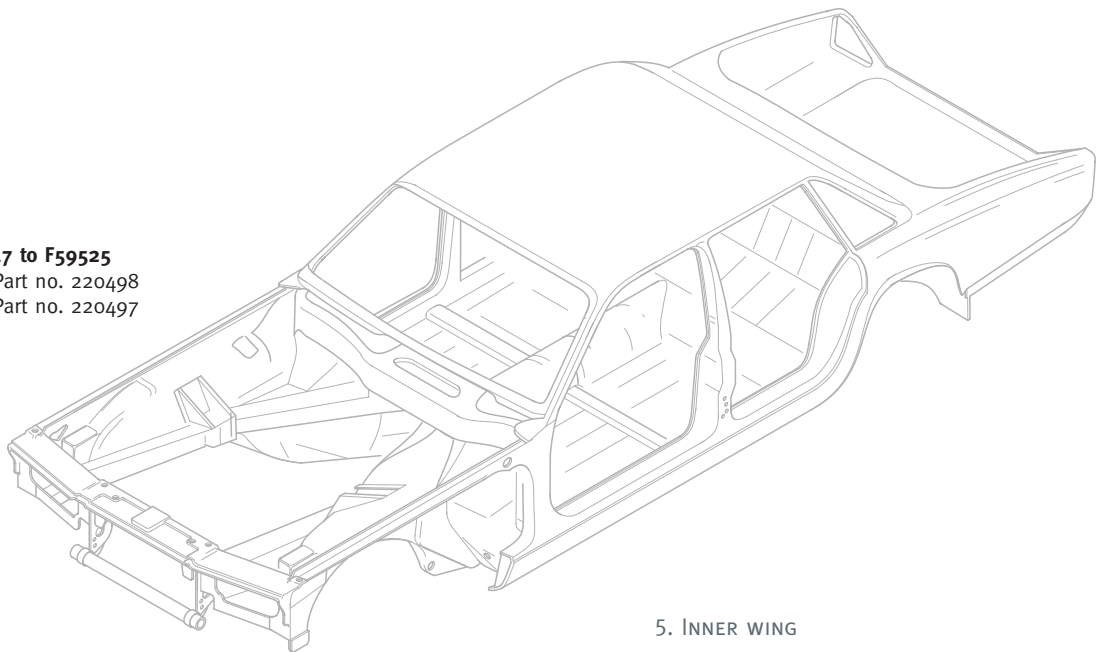

2. SUPPORT PANEL

headlamp

X308 3.2 and 4.0 from VIN...812317 to F59525

LH. Part no. 396737

RH. Part no. 396735

3. BRACKET

bonnet hinge

X308 3.2 and 4.0 from VIN...812317 to F59525

LH. Part no. 396703

RH. Part no. 396702

4. END PANEL

inner wing, front section

X308 3.2 and 4.0 from VIN...812317 to F59525

LH. Part no. 396755

RH. Part no. 396754

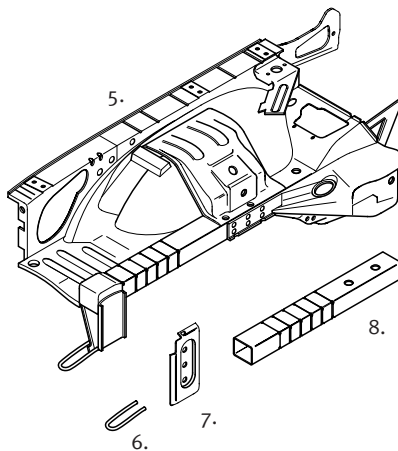

5. INNER WING

including chassis rail

X308 3.2 and 4.0 from VIN...812317 to F59525

LH. Part no. 396748

RH. Part no. 396745

6. TOWING EYE

front

X308 3.2 and 4.0 from VIN...812317 to F59525

Part no. 220455

7. SUPPORT PANEL

radiator

X308 3.2 and 4.0 from VIN...812317 to F59525

LH. Part no. 396740

RH. Part no. 396739

8. MAIN CHASSIS RAIL

front

X308 3.2 and 4.0 from VIN...812317 to F59525

LH. Part no. 396752

RH. Part no. 396750

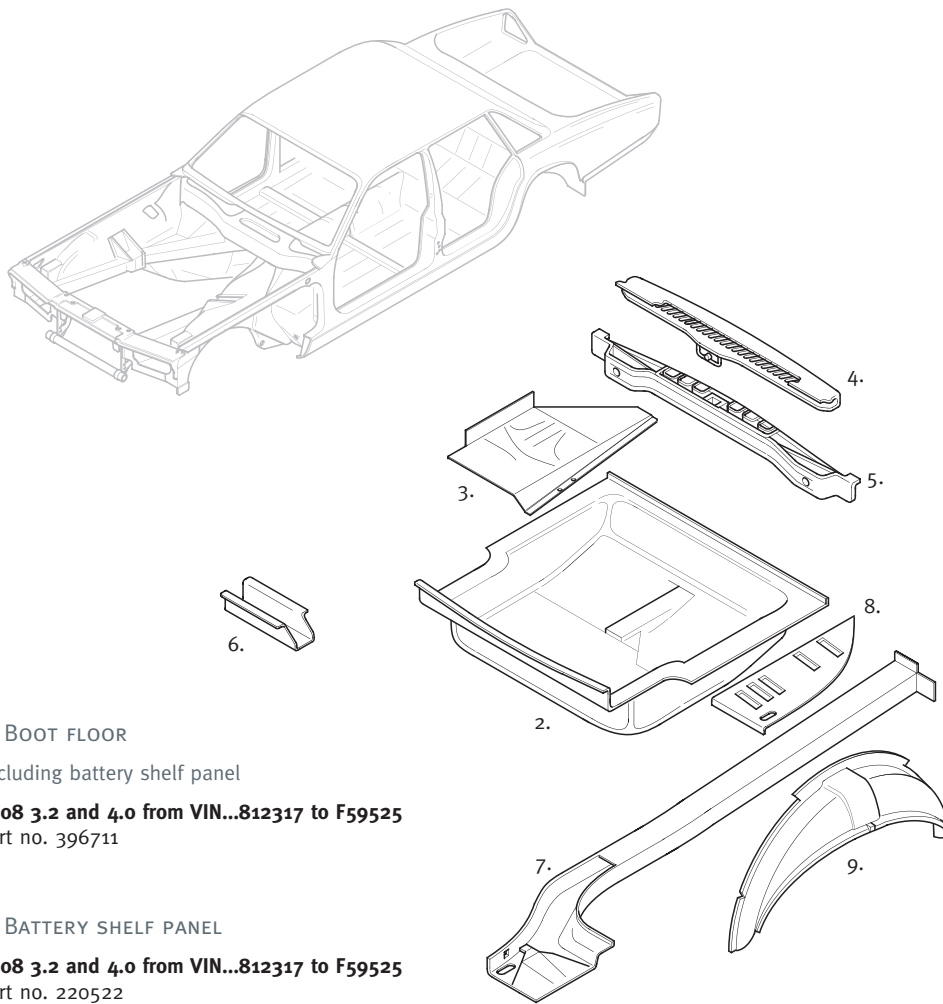

1. BOOT FLOOR
including battery shelf panel

X308 3.2 and 4.0 from VIN...812317 to F59525
Part no. 396758

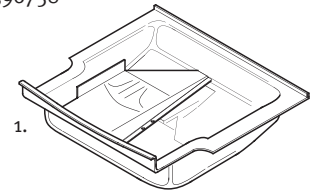

2. BOOT FLOOR
excluding battery shelf panel

X308 3.2 and 4.0 from VIN...812317 to F59525
Part no. 396711

3. BATTERY SHELF PANEL

X308 3.2 and 4.0 from VIN...812317 to F59525
Part no. 220522

4. REAR VALANCE

upper

X308 3.2 and 4.0 from VIN...812317 to F59525
Part no. 396690

5. REAR VALANCE

lower

X308 3.2 and 4.0 from VIN...812317 to F59525
Part no. 348114

6. JACKING POINT

rear

X308 3.2 and 4.0 from VIN...812317 to F59525
LH. Part no. 258196
RH. Part no. 258195

7. MAIN CHASSIS RAIL

rear

X308 3.2 and 4.0 from VIN...812317 to F59525
LH. Part no. 396761
RH. Part no. 396760

8. END PANEL

boot floor

X308 3.2 and 4.0 from VIN...812317 to F59525
LH. Part no. 257831
RH. Part no. 257793

9. WHEEL ARCH

rear - outer half

X308 3.2 and 4.0 from VIN...812317 to F59525
LH. Part no. 257761
RH. Part no. 257759

10. REPAIR PANEL

rear wing lip (needs modification to suit)

X308 3.2 and 4.0 from VIN...812317 to F59525
LH. Part no. 329655
RH. Part no. 329656



1. BUMPERS

1. BUMPER

front - primed

X308 3.2 and 4.0 from VIN...812317 to F59525

Part no. 484573



1.

2. BUMPER ARMATURE

front bumper

X308 3.2 and 4.0 from VIN...812317 to F59525

Part no. 415636



2.

3. BUMPER BRACKET

front bumper

X308 3.2 and 4.0 from VIN...812317 to F59525

Qty. required: 2Part no. 238227



3.

4. FITTING KIT

front bumper

X308 3.2 and 4.0 from VIN...812317 to F59525

Part no. 422278



4.

5. THREADED RIVET

front bumper

X308 3.2 and 4.0 from VIN...812317 to F59525
Qty. required: 8 Part no. 281536



5.

6. POP RIVET

plastic - front bumper

X308 3.2 and 4.0 from VIN...812317 to F59525
Qty. required: 4 Part no. 495915



6.

7. POP RIVET

front bumper

X308 3.2 and 4.0 from VIN...812317 to F59525
Qty. required: 2 Part no. 13674



7.

8. THREADED RIVET

front bumper

X308 3.2 and 4.0 from VIN...812317 to F59525
Qty. required: 8 Part no. 281547



8.

9. RETAINING CLIP

made from plastic - front bumper

X308 3.2 and 4.0 from VIN...812317 to F59525
Qty. required: 2 Part no. 424939



9.

10. RETAINING CLIP

„fir tree“ type - front bumper

X308 3.2 and 4.0 from VIN...812317 to F59525
Qty. required: 4 Part no. 281580



10.

11. POP RIVET

front bumper

X308 3.2 and 4.0 from VIN...812317 to F59525
Qty. required: 4 Part no. 7064



11.

12. MOULDING

on front bumper, chromed

X308 3.2 and 4.0 with headlamp powerwash system from VIN...812317 to F59525
LH. Part no. 415649
RH. Part no. 415647



12.

X308 3.2 and 4.0 with headlamp powerwash system from VIN...812317 to F59525
LH. Part no. 415650
RH. Part no. 415648

1. BUMPERS

13. BUMPER

rear - primed

X308 3.2 and 4.0 without rear parking aid from VIN...812317 to F59525

Part no. 484571

X308 3.2 and 4.0 with rear parking aid from VIN...F20645 to F59525

Part no. 416058

13.



14. BUMPER ARMATURE

rear bumper

X308 3.2 and 4.0 from VIN...812317 to F59525

Part no. 355143

14.



15. BUMPER ARMATURE

rear bumper

X308 3.2 and 4.0 from VIN...812317 to F59525

Qty. required: 2Part no. 238228

15.



16. MOULDING

on rear bumper, chromed

X308 3.2 and 4.0 from VIN...812317 to F59525

LH. Part no. 415661

RH. Part no. 415660

16.



17. SPIRE NUT

rear bumper

X308 3.2 and 4.0 from VIN...812317 to F59525

Qty. required: 3Part no. 424772

17.

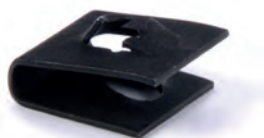

18. POP RIVET

rear bumper

X308 3.2 and 4.0 from VIN...812317 to F59525

Qty. required: 4Part no. 424918

18.



19. POP RIVET

with 3/16" diameter - rear bumper

X308 3.2 and 4.0 from VIN...812317 to F59525

Qty. required: 10Part no. 7064

19.



20. RETAINING CLIP

plastic - rear bumper

X308 3.2 and 4.0 from VIN...812317 to F59525

Qty. required: 2Part no. 424939

20.



1. RADIATOR GRILLE AND AIR INTAKE GRILLE

1. RADIATOR GRILLE SURROUND

chromed

**X308 3.2 and 4.0 Jaguar models
from VIN...812317 to F59525**
Part no. 415618

primed

**X308 3.2 and 4.0 Jaguar models
from VIN...812317 to F59525**
Part no. 415620



1.

2. RADIATOR GRILLE SURROUND

chromed

**X308 3.2 and 4.0 Daimler models
from VIN...812317 to F59525**
Part no. 415619



2.

3. RADIATOR GRILLE PANEL

LH section, chromed

**X308 3.2 and 4.0 except 4.0 Supercharged
from VIN...812317 to F59525**
Part no. 415615

RH section, chromed

**X308 3.2 and 4.0 except 4.0 Supercharged
from VIN...812317 to F59525**
Part no. 415612

LH section, primed

**X308 3.2 and 4.0 except 4.0 Supercharged
from VIN...812317 to F59525**
Part no. 415617

RH section, primed

**X308 3.2 and 4.0 except 4.0 Supercharged
from VIN...812317 to F59525**
Part no. 415614



3.



4. RADIATOR GRILLE PANEL

LH section, black finish

X308 4.0 Supercharged
 from VIN...812317 to F59525
 Part no. 415616

RH section, black finish

X308 4.0 Supercharged
 from VIN...812317 to F59525
 Part no. 415613



4.



5. RADIATOR GRILLE PANEL

XJR variant made from stainless steel. Allows far more air to your radiator than common slatted grilles. Supplied in pairs

X308 3.2 and 4.0 from VIN...812317 to F59525
 Part no. 495952



5.



6. BADGE

for radiator grille with silver ,Jaguar' head

X308 3.2 and 4.0 Jaguar models
 from VIN...812317 to F59525
 Part no. 415981



6.

7. BADGE

for radiator grille with golden ,Daimler' logo

X308 3.2 and 4.0 Daimler models
 from VIN...812317 to F59525
 Part no. 415982



7.

8. HEADLAMP COVER

LH headlamps - primed

X308 3.2 and 4.0 from VIN...812317 to F59525
 Part no. 415596

RH headlamps - primed

X308 3.2 and 4.0 from VIN...812317 to F59525
 Part no. 348141

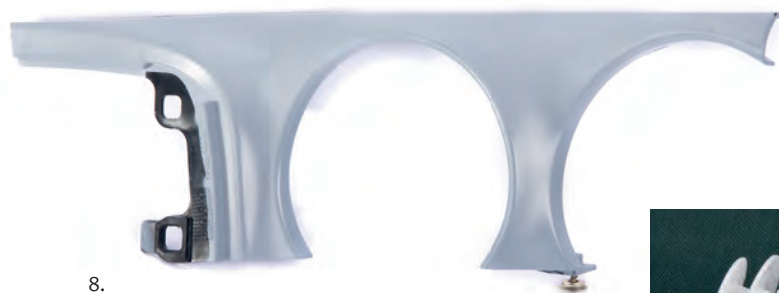

8.

9. RETAINING CLIP

headlamp cover

X308 3.2 and 4.0 from VIN...812317 to F59525
 Qty. required: 2 Part no. 281581



9.

1. RADIATOR GRILLE AND AIR INTAKE GRILLE

10. MOULDING

below radiator grille - chromed

X308 3.2 and 4.0 from VIN...812317 to F59525
Part no. 415665

below radiator grille - primed

X308 3.2 and 4.0 from VIN...812317 to F59525
Part no. 415664

11. THREADED RIVET

moulding

X308 3.2 and 4.0 from VIN...812317 to F59525
Qty. required: 3 Part no. 281547

10.



11.



12. AIR INTAKE GRILLE

in front bumper - XJR variant

X308 3.2 and 4.0 from VIN...812317 to F59525
Part no. 421868

12.



1. NAMEPLATE

on ,B' post. Chromed ,V8' lettering on black surface, self-adhesive

X308 3.2 and 4.0 from VIN...812317 to F59525
Qty. required: 2Part no. 416000



1.

2. NAMEPLATE

on ,B' post. Golden ,Daimler' lettering on black surface, self-adhesive

X308 3.2 and 4.0 Daimler models from VIN...812317 to F59525
Qty. required: 2Part no. 271233



2.

3. NAMEPLATE

on boot lid, LH side. Chrome frame with white ,Jaguar' lettering on grey surface, self-adhesive

X308 3.2 and 4.0 Jaguar models from VIN...812317 to F59525
Part no. 415996



3.

4. NAMEPLATE

on boot lid, LH side. Black frame with silver ,Jaguar' lettering on grey surface, self-adhesive

X308 3.2 and 4.0 Jaguar models from VIN...812317 to F59525
Part no. 415998



4.

5. NAMEPLATE

on boot lid, LH side. Chrome frame with golden ,Daimler' lettering on grey surface, self-adhesive

X308 3.2 and 4.0 Daimler models from VIN...812317 to F59525
Part no. 415997



5.

6. NAMEPLATE

on boot lid, LH side. Chrome frame with black ,Jaguar' lettering on black surface, self-adhesive

X308 4.0 XJR100 edition
Part no. 495898



6.

7. NAMEPLATE

on boot lid, RH side. Chrome frame with white ,XJ8' lettering on grey surface, self-adhesive

X308 3.2 and 4.0 from VIN...812317 to F59525
Part no. 415985



7.

8. NAMEPLATE

on boot lid, RH side. Black frame with white ,XJ8' lettering on grey surface, self-adhesive

X308 3.2 and 4.0 from VIN...812317 to F59525
Part no. 415983



8.

1. BADGES AND NAMEPLATES

9. NAMEPLATE

on boot lid, RH side. Chrome frame with golden ,V8' lettering on grey surface, self-adhesive

X308 3.2 and 4.0 from VIN...812317 to F59525
Part no. 415989

9.



10. NAMEPLATE

on boot lid, RH side. Black frame with white ,XJ Sport' lettering on grey surface, self-adhesive

X308 3.2 and 4.0 from VIN...812317 to F59525
Part no. 415988

10.



11. NAMEPLATE

on boot lid, RH side. Chrome frame with white ,XJR' lettering on grey surface, self-adhesive

X308 4.0 Supercharged
from VIN...853936 to F59525
Part no. 415995

11.



12. NAMEPLATE

on boot lid, RH side. Black frame with white ,XJR' lettering on grey surface, self-adhesive

X308 4.0 Supercharged
from VIN...853936 to F59525
Part no. 415993

12.



13. NAMEPLATE

on boot lid, RH side. Chrome frame with white ,Sovereign' lettering on grey surface, self-adhesive

X308 3.2 and 4.0 from VIN...812317 to F59525
Part no. 415986

13.



14. NAMEPLATE

on boot lid, RH side. Chrome frame with golden ,Centenary' lettering on black surface, self-adhesive

X308 3.2 and 4.0 Centenary edition
Part no. 272049

14.



15. NAMEPLATE

on boot lid, RH side. Chrome frame with black/red ,XJR 100' lettering on white surface, self-adhesive

X308 4.0 XJR100 edition
Part no. 495900

15.



16. NAMEPLATE

on boot lid, RH side. Chrome frame with white ,XJ8 SE' lettering on grey surface, self-adhesive

X308 3.2 and 4.0 XJ8 SE edition
Part no. 495901

16.



1. GAS STRUT

bonnet

X308 3.2 and 4.0 from VIN...812317 to F59525

Qty. required: 2Part no. 235275



2. DOOR CHECK STRAP

front door

X308 3.2 and 4.0 from VIN...812317 to F59525

Qty. required: 2Part no. 262021



3. SEAL

check strap front door

X308 3.2 and 4.0 from VIN...812317 to F59525

Qty. required: 2Part no. 263650

4. PIVOT BOLT

check strap front door

X308 3.2 and 4.0 from VIN...812317 to F59525

Qty. required: 2Part no. 241754



5. NUT

check strap front door

X308 3.2 and 4.0 from VIN...812317 to F59525

Qty. required: 2Part no. 241755



Online Shop!
www.Limora.com



2. BODY FITTINGS

6. DOOR CHECK STRAP

rear door

X308 3.2 and 4.0 from VIN...812317 to F59525
 Qty. required: 2 Part no. 262141



6.

7. SEAL

check strap rear door

X308 3.2 and 4.0 from VIN...812317 to F59525
 Qty. required: 2 Part no. 264113



7.

8. PIVOT BOLT

check strap rear door

X308 3.2 and 4.0 from VIN...812317 to F59525
 Qty. required: 2 Part no. 241754



8.



9.

9. NUT

check strap rear door

X308 3.2 and 4.0 from VIN...812317 to F59525
 Qty. required: 2 Part no. 241755

10. THREADED RIVET

plastic - bonnet liner

X308 3.2 and 4.0 from VIN...812317 to F59525
 Qty. required: 25. Part no. 281548



10.

11. RETAINING CLIP

plastic - boot lid liner

X308 3.2 and 4.0 from VIN...812317 to F59525
 Qty. required: 18. Part no. 495896



11.

12. POP RIVET

plastic - for protectors in front and rear wheel arches

X308 3.2 and 4.0 from VIN...812317 to F59525
 Qty. required: 16. Part no. 281538



12.

13. TUBE NUT

plastic - for protectors in front and rear wheel arches

X308 3.2 and 4.0 from VIN...812317 to F59525
 Qty. required: 4 Part no. 374182



13.

14. RETAINING CLIP

plastic - for protectors in front and rear wheel arches

X308 3.2 and 4.0 from VIN...812317 to F59525
 Qty. required: 4 Part no. 495896



14.

15. REMOTE KEY FOB

with 433 mhz standard sensitivity. Please note: This article must be hard-coded by an authorised Jaguar workshop

X308 3.2 and 4.0 from VIN...812317 to F20644
Qty. required: 2Part no. 282098

with 315 mhz low sensitivity. Please note: This article must be hard-coded by an authorised Jaguar workshop

X308 3.2 and 4.0 from VIN...812317 to F20644
Qty. required: 2Part no. 282097

with 315 mhz low sensitivity. Please note: This article must be hard-coded by an authorised Jaguar workshop

X308 3.2 and 4.0 from VIN...812317 to F20644
Qty. required: 2Part no. 282099

with 433 mhz standard sensitivity. Please note: This article must be hard-coded by an authorised Jaguar workshop

X308 3.2 and 4.0 from VIN...F41863 to F59525
Qty. required: 2Part no. 427832

with 315 mhz standard sensitivity. Please note: This article must be hard-coded by an authorised Jaguar workshop

X308 3.2 and 4.0 from VIN...F41863 to F59525
Qty. required: 2Part no. 427831

17. AERIAL

electric retractable - for radio

X308 3.2 and 4.0 from VIN...812317 to F59525
Part no. 283173

18. AERIAL MAST

X308 3.2 and 4.0 from VIN...812317 to F59525
Part no. 283176

19. GROMMET

aerial sealing

X308 3.2 and 4.0 from VIN...812317 to F59525
Part no. 282403



15.

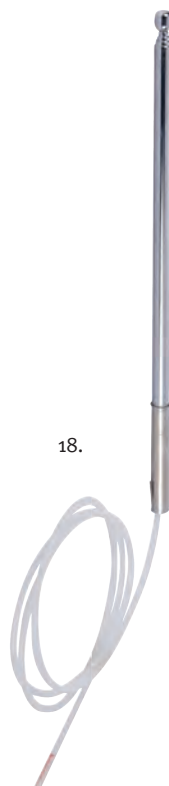

18.



17.



19.

16. KEY

blank with Jaguar head. Not suitable for cars with key immobiliser system

X308 3.2 and 4.0 from VIN...812317 to F59525
Qty. required: 2Part no. 278419

blank with Jaguar head. Suitable for cars with key immobiliser system. Please note: This article must be hard-coded by an authorised Jaguar workshop

X308 3.2 and 4.0 from VIN...812317 to F00034
Qty. required: 2Part no. 271373

blank with Jaguar head. Suitable for cars with key immobiliser system. Please note: This article must be hard-coded by an authorised Jaguar workshop

X308 3.2 and 4.0 from VIN...F00035 to F59525
Qty. required: 2Part no. 495905



16.

2. BODY FITTINGS

20. GAS STRUT

boot lid

X308 3.2 and 4.0 from VIN...812317 to F59525

Qty. required: 2 Part no. 403154



20.

21. SEALING RUBBER

boot lid

X308 3.2 and 4.0 from VIN...812317 to F59525

Part no. 414847



21.

22. MOULDING

front wing - chromed

X308 3.2 and 4.0 from VIN...812317 to F59525

LH. Part no. 414875

RH. Part no. 271146

front door - chromed

X308 3.2 and 4.0 from VIN...812317 to F59525

LH. Part no. 414877

RH. Part no. 414876

rear door - chromed

**X308 3.2 and 4.0 LWB models
from VIN...812317 to F59525**

LH. Part no. 416769

RH. Part no. 416768

rear door - made from chromed plastic

**X308 3.2 and 4.0 SWB models
from VIN...812317 to F59525**

LH. Part no. 271163

RH. Part no. 271160



22.

23. MOULDING

front wing - primed

X308 3.2 and 4.0 from VIN...812317 to F59525
 LH.Part no. 271141
 RH.Part no. 271140

front door - primed

X308 3.2 and 4.0 from VIN...812317 to F59525
 LH.Part no. 271143
 RH.Part no. 271142

rear door - primed

X308 3.2 and 4.0 LWB models from VIN...812317 to F59525
 LH.Part no. 272038
 RH.Part no. 272037

X308 3.2 and 4.0 SWB models from VIN...812317 to F59525
 LH.Part no. 271145
 RH.Part no. 271144



23.

24. LEAPING CAT

chrome plated, spring loaded. Length: 7"

X308 3.2 and 4.0 from VIN...812317 to F59525
 Part no. 347752

25. LEAPING CAT

chrome plated, spring loaded. Length: 5"

X308 3.2 and 4.0 from VIN...812317 to F59525
 Part no. 347753



24.



25.

Did you know... ?

The driver is not the only vulnerable person on the road. We have to have a partnership with pedestrians and improve coexistence. This can be improved by the shape of the front of vehicles to improve the kinetics of impact with pedestrians. A major element is the hood ornament which should not resist impact but with the use of predetermined breaking points should be easily removed. Replacement is easy from our range.



1. MIRRORS, GLASS AND GLAZING

1. WINDSCREEN

tinted glass - non heated, no rain sensor aperture

X308 3.2 and 4.0 from VIN...812317 to F59525
Part no. 422299

tinted glass - heated, no rain sensor aperture

X308 3.2 and 4.0 from VIN...812317 to F59525
Part no. 422298

tinted glass - non heated, with rain sensor aperture

X308 3.2 and 4.0 from VIN...812317 to F59525
Part no. 410020

tinted glass - heated, with rain sensor aperture

X308 3.2 and 4.0 from VIN...812317 to F59525
Part no. 348065



2. GLAZING RUBBER

windscreen

X308 3.2 and 4.0 from VIN...812317 to F59525
Part no. 261622



3. MOULDING

windscreen - chromed

X308 3.2 and 4.0 from VIN...812317 to F59525

LH sectionPart no. 348578

RH sectionPart no. 224880



4. RETAINING CLIP

windscreen moulding - chromed

X308 3.2 and 4.0 from VIN...812317 to F59525

Qty. required: 2Part no. 224879

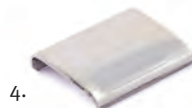

5. RUBBER BUFFER

windscreen

X308 3.2 and 4.0 from VIN...812317 to F59525

Qty. required: 4Part no. 266519



6. GLASS BONDING ADHESIVE

contents: 300 ml adhesive cartridge and 30 ml bottle activator. Supplied with a multilingual instruction sheet

Part no. 317293

7. TOOL KIT

for the removal of bonded screens, supplied in a 7 piece kit. Contents cutting wire, 2 wire handles, bonded screen removal tool, starter tool, trim clip remover and a trim pad remover

Part no. 245566

8. CW 1:100 @ SCREEN TREATMENT

removes blinding, oily films with greatest economy – 1:200 concentrate with dosage head.

250 ml bottle Part no. 492763

The economy of CW 1:100 Classic is unbeatable. One 250 ml bottle can be diluted to a ratio of 1:200, thus produces 50 litres of highly effective cleaning liquid. Removes blinding, oily films from the windscreen, and is the best product for the quality-conscious, economical driver. Special action: Increases the life of windscreen wipers. Can be mixed with any commercial antifreeze. Is also suitable for plastic headlight lenses and fan nozzles.



2. DOOR MIRRORS AND INTERIOR MIRROR

1. MIRROR GLASS

for door mirror with automatic dimming function

X308 3.2 and 4.0 from VIN...812317 to F59525
 flatPart no. 270969
 convex.Part no. 415975

aspheric - for door mirrors with automatic dimming function

X308 3.2 and 4.0 from VIN...812317 to F59525
 Qty. required: 2
 aspheric.Part no. 422380



1.

Did you know... ?

Convex mirrors are slightly curved outwards. This gives a characteristic effect of a reduction in the image size. This means that compared to a conventional mirror the wider view he may be sufficient. Parabolic mirrors are recognizable by a dividing line. The greater part of the surface is a normal mirror, while the outer part of the mirror is more curved so that the field of view is almost doubled. Even objects which for a conventional mirror would be out of view remain visible with an aspherical mirror.



2. MIRROR GLASS

without warning lettering, convex - for door mirror with automatic dimming function, width: 1400 mm

X308 3.2 and 4.0 from VIN...812317 to F59525
 Qty. required: 2Part no. 270971

with warning lettering, convex - for door mirror with automatic dimming function, width: 1400 mm

X308 3.2 and 4.0 from VIN...812317 to F59525
 Qty. required: 2Part no. 270973



2.

3. COVER

door mirror, primed

X308 3.2 and 4.0 from VIN...812317 to F59525
 LH.Part no. 270963
 RH.Part no. 270962

chromed

X308 3.2 and 4.0 from VIN...812317 to F59525
 LH.Part no. 271011
 RH.Part no. 271010



3.

4. RETAINING CLIP

door mirror cover

X308 3.2 and 4.0 from VIN...812317 to F59525
 Qty. required: 6Part no. 271007



4.

5. INTERIOR MIRROR

without automatic dimming function

X308 3.2 and 4.0 from VIN...812317 to F59525
Part no. 272026



6. INTERIOR MIRROR

with automatic dimming function, without twilight sentinel. Fits to cars with daytime running lamps option

X308 3.2 and 4.0 from VIN...812317 to 878717
Part no. 270096

with automatic dimming function and rain sensing system. Fits to cars with auto headlamp option

X308 3.2 and 4.0 from VIN...F00035 to F59525
Part no. 413782

with automatic dimming function, without rain sensing system. Fits to cars with auto headlamp option

X308 3.2 and 4.0 from VIN...F00035 to F59525
Part no. 413780

with automatic dimming function and twilight sentinel. Fits to cars with auto headlamp option

X308 3.2 and 4.0 from VIN...812317 to 878717
Part no. 415579



1. JAGUAR GEAR KNOB

for selector lever. Made from light hazelnut, without logo

X308 3.2 and 4.0 from VIN...812317 to F59525
Part no. 284587



1.

2. CONE

for selector lever 284587

X308 3.2 and 4.0 from VIN...812317 to F59525
Part no. 495910



2.

3. JAGUAR GEAR KNOB

for selector lever. Made from dark walnut, with engraved 'Jaguar' logo

X308 3.2 and 4.0 from VIN...812317 to F59525
Part no. 495666



3.

4. GEAR KNOB

for selector lever. reproduction made from dark walnut and comes without logo

X308 3.2 and 4.0 from VIN...812317 to F59525
Part no. 349113



4.

5. GEAR KNOB

for selector lever. Reproduction made from light hazelnut and comes without logo

X308 3.2 and 4.0 from VIN...812317 to F59525
Part no. 349112



5.

6. JAGUAR GEAR KNOB

for selector lever. Made from chromed aluminium, without logo

X308 3.2 and 4.0 from VIN...812317 to F59525
Part no. 495667



6.

1. FOOTWELL CARPETS, GEAR KNOBS AND THRESHOLD PLATES

7. HOLDER

for cup in console lid

X308 3.2 and 4.0 from VIN...812317 to F59525
Part no. 405577



8. MAGAZINE

for original Jaguar CD autochanger

X308 3.2 and 4.0 from VIN...812317 to F59525
Part no. 390815



1. FOOTWELL CARPETS, GEAR KNOBS AND THRESHOLD PLATES

9. BOOT MATS

dark grey - supplied in pairs, for cars with compact disc player

X308 3.2 and 4.0 from VIN...812317 to F59525
Part no. 421935

dark grey - for cars without compact disc player

X308 3.2 and 4.0 from VIN...812317 to F59525
Part no. 276873

Did you know... ?

This mat provides added protection of the original luggage compartment carpet to ensure your vehicle is kept in pristine condition. The mat is resistant to water, mud, grease and other materials likely to soil the original compartment carpet. The mat has a non-slip backing to keep it securely in place.



10. BOOT LINER

plastic - for cars without compact disc player

X308 3.2 and 4.0 from VIN...812317 to F59525
Part no. 422376

Did you know... ?

Designed to exactly match the vehicle's boot to maximise space and protection. Ideal for stowing golf and other sports equipment. This easy to clean liner assures minimal cargo movement and can be installed and removed quickly.



1. FOOTWELL CARPETS, GEAR KNOBS AND THRESHOLD PLATES

11. THRESHOLD PLATE

front door sill - stainless steel with ,Jaguar' lettering

X308 3.2 and 4.0
from VIN...812317 to F59525

Qty. required: 2Part no. 236375

rear door sill - stainless steel with ,Jaguar' lettering

X308 3.2 and 4.0 LWB models
from VIN...812317 to F59525

Qty. required: 2Part no. 272054

rear door sill - stainless steel with ,Jaguar' lettering

X308 3.2 and 4.0 SWB models
from VIN...812317 to F59525

Qty. required: 2Part no. 270511

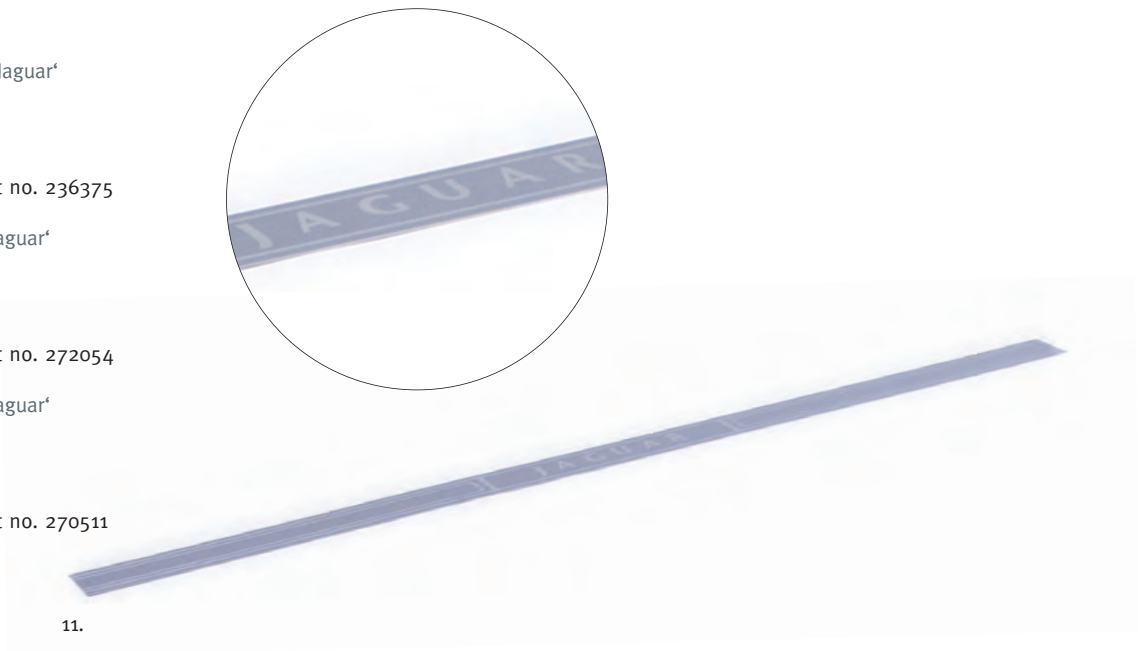

11.

12. THRESHOLD PLATE

front door sill - stainless steel with ,Daimler' lettering

X308 3.2 and 4.0 from VIN...812317 to F59525

Qty. required: 2Part no. 236373

rear door sill - stainless steel with ,Daimler' lettering

X308 3.2 and 4.0 LWB models
from VIN...812317 to F59525

Qty. required: 2Part no. 272052

rear door sill - stainless steel with ,Daimler' lettering

X308 3.2 and 4.0 SWB models
from VIN...812317 to F59525

Qty. required: 2Part no. 270512



12.

13. THRESHOLD PLATE

front door sill - stainless steel with ,XJR 100' lettering

X308 4.0 XJR100 edition

Qty. required: 2Part no. 416810

rear door sill - stainless steel with ,XJR 100' lettering

X308 4.0 XJR100 edition

Qty. required: 2Part no. 416811

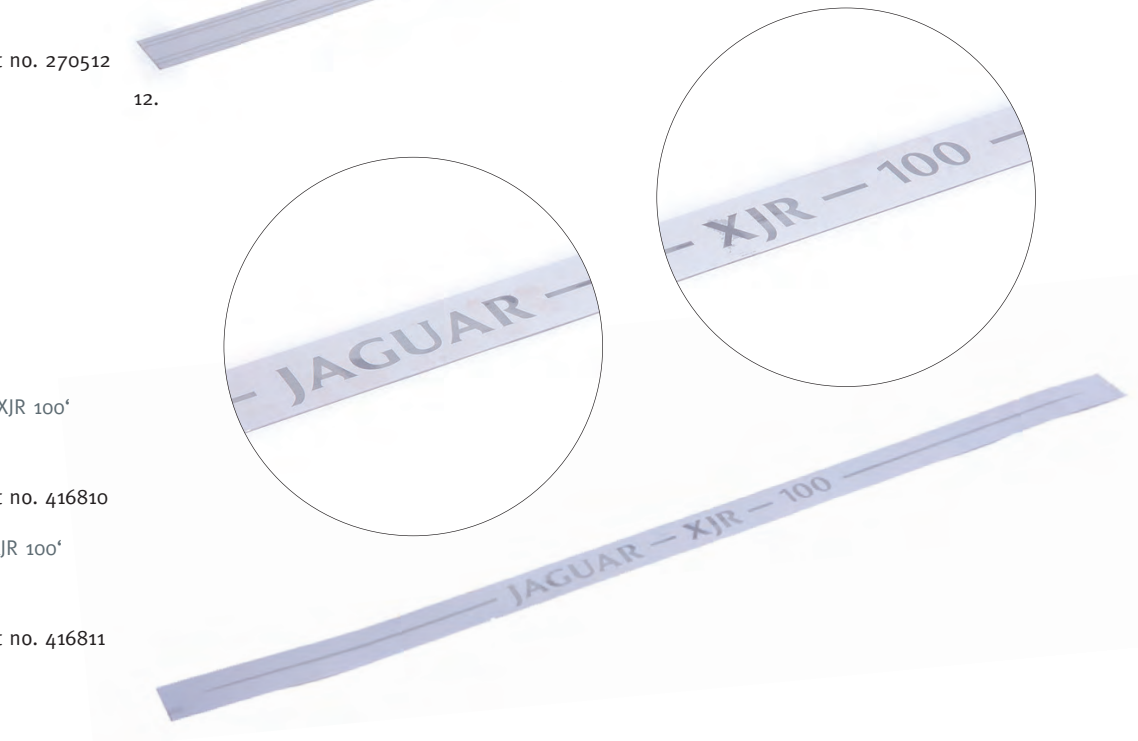

13.

1. FOOTWELL CARPETS, GEAR KNOBS AND THRESHOLD PLATES

14. RUBBER MATS

front footwell, black - supplied in pairs

X308 3.2 and 4.0 from VIN...812317 to F59525
Part no. 276925

rear footwell, black - supplied in pairs

X308 3.2 and 4.0 from VIN...812317 to F59525
Part no. 422240

Did you know... ?

Rubber mats not only have an aesthetic effect, but are a real safety feature: The non-porous surface resists liquids getting into carpet and insulation materials and enables liquids to evaporate again relatively quickly. This reduces the amount of liquid circulating in the winter, making the vehicle less likely to steam up. Less flying blind, and better vision contribute significantly to road safety.



14.

15. FOOTWELL CARPETS

sable - supplied in sets of 4 for LHD models

X308 3.2 and 4.0 SWB models
from VIN...812317 to F59525
Part no. 495909

X308 3.2 and 4.0 LWB models
from VIN...812317 to F59525
Part no. 496962

sable - supplied in sets of 4 for RHD models

X308 3.2 and 4.0 SWB models
from VIN...812317 to F59525
Part no. 422140

X308 3.2 and 4.0 LWB models
from VIN...812317 to F59525
Part no. 496963



15.

1. FOOTWELL CARPETS, GEAR KNOBS AND THRESHOLD PLATES

16. FOOTWELL CARPETS

flint grey - supplied in sets of 4 for LHD models

**X308 3.2 and 4.0 SWB models
from VIN...812317 to F59525**
Part no. 495908

flint grey - supplied in sets of 4 for LHD models

**X308 3.2 and 4.0 LWB models
from VIN...812317 to F59525**
Part no. 496966

flint grey - supplied in sets of 4 for RHD models

**X308 3.2 and 4.0 SWB models
from VIN...812317 to F59525**
Part no. 496964

flint grey - supplied in sets of 4 for RHD models

**X308 3.2 and 4.0 LWB models
from VIN...812317 to F59525**
Part no. 496965



16.

17. CONNOLLY LEATHER CARE KIT

content: 500 ml leather cleaner and 284 ml hide care waxy cream

Part no. 355874

leather care singly, 284 ml

Part no. 279729

leather cleaner singly, 500 ml

Part no. 498879



17.

1. COMPETITION PARTS

1. FILTERMAG

high performance type, for oil filters from 2.90“ to 3.40“ diameter, height 2.625“

X308 3.2 and 4.0 from VIN...812317 to F59525
Part no. 481135

Close the gap filter!

Even with a 2.22micron filter there will be abrasive particles producing constant engine wear. FilterMAG patented design of support system and neodymium-samarium-iron-boron magnet holds the super-fine particles on the inside of the oil filter.

- Extremely strong magnetic field strength of the separation model RA450 at only 28.19 cm² contact surface incredible 362.87 kg
- Heat resistant to 150° C
- Unlimited re-useable



1.

3. CONNECTOR

for oil drain valve. thread: M22 x 1.5 - angle: 45°, hose length: 25 cm

X308 3.2 and 4.0 from VIN...812317 to F59525
Part no. 487915



3.

2. OIL DRAIN VALVE

steel - may replace original drain plug on engine

X308 3.2 and 4.0 from VIN...812317 to F59525
Part no. 488046

for the environmentally friendly oil change: No more dirty or burnt fingers, no spatter, no spill, no contaminated soil - no bad conscience. We produce this high quality product from the finest materials in a medium sized workshop in Germany. The system is a simple but ingenious screw drain with hose connection. The shutter opens automatically and closes automatically when the drain hose is unscrewed. No more worries about ruined threads or forgetting to replace the cap. Even though you don't see this item very often it is still a classy feature.



2.

4. OIL DRAIN PAN

16 l volume, height: 14 cm, integrated funnel, large handles, acid resistant, antisplash-system, very practical for a convenient and clean oil change

Part no. 293584



4.



integrated funnel

4.



Anti-Splash-System

4.



May replace original filter element and has the following benefits: high air flow with excellent filtration, will lead to more horsepower and better acceleration, washable and reusable.

5. K&N AIR FILTER

element

X308 3.2 and 4.0 from VIN...812317 to F59525
Part no. 486030



For K&N air filter cleaner and air filter oils see chapter 21.6



6. THERMOSTAT HOUSING

new improved alloy version

This upgrade kit replaces the original plastic thermostat housing. We have put together an aluminum thermostat housing assembly, more durable than its plastic counterpart. This kit will include the housing, cap, thermostat cover and seals. This is an exact reproduction of the plastic version and will meet or exceed the factory specifications.

X308 3.2 and 4.0 except Supercharged
from VIN...812317 to F59525
 Part no. 488148



7. WHEEL ARCH SET

stainless steel, installation either with clips or screws

X308 3.2 and 4.0 from VIN...812317 to F59525
 Part no. 319829



8. BATTERY-BOOSTER

12 volts, 800 ampere, integrated wires with claps, illumination with 2 bright LED, small dimension, only 2.6 kg! Variant with Euro plug

This battery booster is the smallest most powerful jumpstart pack in its class with a 14AH high capacity. The booster delivers instant cold crank power when you need it and has a fast rechargeable long life battery. It is easy to handle, the total weight is only 2.6 kg and it is extremely compact, making it easy to store in your car, camper van, boat or jet ski.

Part no. 492832

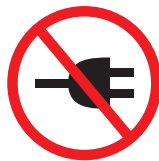

- unbelievable strong
- doesn't need a socket
- Lithium Ion Battery
- only 4,6 kg

8.

1. COMPETITION PARTS

9. C TEK BATTERY CHARGER

This battery charger can solve a broad range of battery-related problems and is the perfect charger for those with high demands. The Ctek MXS5.0 offers features such as battery diagnosis that shows if a battery can receive and retain a charge, a special reconditioning function that restores stratified and deeply discharged batteries, unique maintenance charging, a mode for optimised charging during cold winter days and the charging of demanding AGM batteries (i.e. Optima).

with Euro plug
Part no. 496284

with UK plug
Part no. 496285



9.



10. REMOTE KEY FOB

with 433 mhz standard sensitivity. Please note: This article must be hard-coded by an authorised Jaguar workshop

X308 3.2 and 4.0 from VIN...812317 to F20644
Qty. required: 2Part no. 282098

with 315 mhz low sensitivity. Please note: This article must be hard-coded by an authorised Jaguar workshop

X308 3.2 and 4.0 from VIN...812317 to F20644
Qty. required: 2Part no. 282097

with 315 mhz low sensitivity. Please note: This article must be hard-coded by an authorised Jaguar workshop

X308 3.2 and 4.0 from VIN...812317 to F20644
Qty. required: 2Part no. 282099

with 433 mhz standard sensitivity. Please note: This article must be hard-coded by an authorised Jaguar workshop

X308 3.2 and 4.0 from VIN...F41863 to F59525
Qty. required: 2Part no. 427832

with 315 mhz standard sensitivity. Please note: This article must be hard-coded by an authorised Jaguar workshop

X308 3.2 and 4.0 from VIN...F41863 to F59525
Qty. required: 2Part no. 427831



10.

11. AIR INTAKE GRILLE

in front bumper - XJR variant

X308 3.2 and 4.0 from VIN...812317 to F59525
Part no. 421868



11.

12. MUDFLAP

front - supplied in pairs

X308 3.2 and 4.0 from VIN...812317 to F59525
Part no. 348062

rear - supplied in pairs

X308 3.2 and 4.0 from VIN...812317 to F59525
Part no. 422114



13. EBC BRAKE PADS

front, Kevlar ,green stuff' specification

The material used in ,green stuff 2000 series' brake pads is Kevlar based. The brake pads give a strong progressive braking from low temperature up to 900°F, they are great for fast road, road sport and light race cars. Most ,green stuff' brake pads are type approved ,E' marked and meet the Reg.90 certification, this information will be found on bottom of each package. As an added bonus Kevlar based brake pads produce less brake dust than other materials and have fantastic wear life.

X308 3.2 and 4.0 except ,R' performance options (Brembo brakes)
from VIN...812317 to F59525

Part no. 497061

X308 3.2 and 4.0 with ,R' performance options (Brembo brakes)
from VIN...812317 to F59525

Part no. 497063



14. EBC BRAKE PADS

front, Ceramic ,red stuff' specification

This material is a Kevlar® fibre based brake compound enhanced with ceramic particles. Being a hard wearing pad, bed-in times can be as long as 1000 miles and drivers must be patient until the pad takes up the shape of their disc. This is a truly impressive fast road pad for repeated heavy braking. It emits far less dust than semi-metallic pads and has been proven to stop a passenger car 13 metres quicker than OEM pads from 100mph/160kph. Features EBC Brake-In surface coating which conditions disc surface and accelerates pad bed-in. Nominal friction coefficient 0.5 with approx. 50% dust reduction. Most EBC Red Ceramic pads are approved to ECE R90 brake safety regulation.

X308 3.2 and 4.0 except ,R' performance options (Brembo brakes)
from VIN...812317 to F59525

Part no. 485429

X308 3.2 and 4.0 with ,R' performance options (Brembo brakes)
from VIN...812317 to F59525

Part no. 497062



1. COMPETITION PARTS

15. EBC BRAKE PADS

rear, Kevlar ,green stuff' specification. Feature: brake system with 305 mm disc

The material used in ,green stuff 2000 series' brake pads is Kevlar based. The brake pads give a strong progressive braking from low temperature up to 900°F, they are great for fast road, road sport and light race cars. Most ,green stuff' brake pads are type approved ,E' marked and meet the Reg.90 certification, this information will be found on bottom of each package. As an added bonus Kevlar based brake pads produce less brake dust than other materials and have fantastic wear life.

X308 3.2 and 4.0 except ,R' performance options (Brembo brakes)
from VIN...812317 to F59525

Part no. 497394

X308 3.2 and 4.0 with ,R' performance options (Brembo brakes)
from VIN...853936 to F59525

Part no. 497396



16. EBC BRAKE PADS

rear, Kevlar ,red stuff' specification. Feature: brake system with 305 mm disc

This material is a Kevlar® fibre based brake compound enhanced with ceramic particles. Being a hard wearing pad, bed-in times can be as long as 1000 miles and drivers must be patient until the pad takes up the shape of their disc. This is a truly impressive fast road pad for repeated heavy braking. It emits far less dust than semi-metallic pads and has been proven to stop a passenger car 13 metres quicker than OEM pads from 100mph/160kph. Features EBC Brake-In surface coating which conditions disc surface and accelerates pad bed-in. Nominal friction coefficient 0.5 with approx. 50% dust reduction. Most EBC Red Ceramic pads are approved to ECE R90 brake safety regulation.

X308 3.2 and 4.0 except ,R' performance options (Brembo brakes)
from VIN...812317 to F59525

Part no. 497395

X308 3.2 and 4.0 with ,R' performance options (Brembo brakes)
from VIN...853936 to F59525

Part no. 497397



17. RADIATOR GRILLE PANEL

stainless steel. Allows far more air to your radiator than common slatted grilles. Supplied in pairs

X308 3.2 and 4.0 from VIN...812317 to F59525

Part no. 495952





The Koni Classic line makes modern shock absorber technology available for your car!

The Koni Philosophy:

As Koni is known as the shock absorber specialist par excellence, they commit themselves to delivering to their customers the finest quality product with the best performance.

18. KONI SHOCK ABSORBER

front

X308 3.2 and 4.0 except adaptive control damping (C.A.T.S) from VIN...812317 to F59525

Qty. required: 2 Part no. 495104

19. KONI SHOCK ABSORBER

rear

X308 3.2 and 4.0 except adaptive control damping (C.A.T.S) from VIN...812317 to F59525

Qty. required: 2 Part no. 318479



18.

19.

19. LEAPING CAT

chrome plated, spring loaded. Length: 7"

X308 3.2 and 4.0 from VIN...812317 to F59525

Part no. 347752

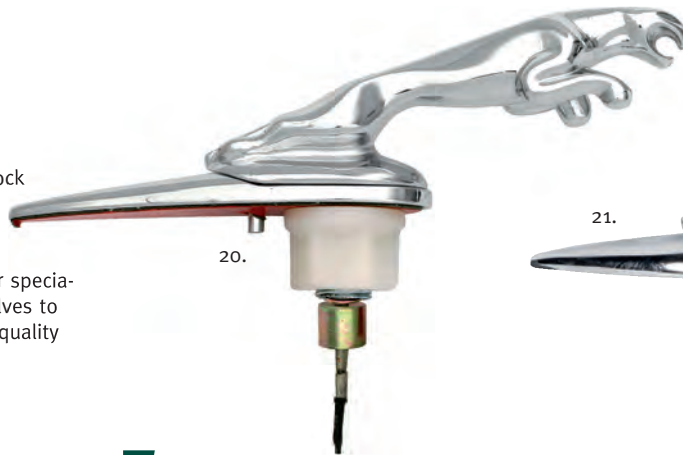

20.

20. LEAPING CAT

chrome plated, spring loaded. Length: 5"

X308 3.2 and 4.0 from VIN...812317 to F59525

Part no. 347753



21.

Easy shunting ? ...without starting the engine

21. DOLLY

built in hydraulic provides easy lifting

- dead easy
- accurate
- ideal in confined space
- comfortable
- no need to start the engine to move the vehicle a short distance
- no sprained back pushing heavy vehicle unaided
- maximum use of space in the garage (thick foam strips on the wall prevent paint damage)
- you can even connect two cars together
- the car can be rotated through 360° on the spot

Did you know... ?

The driver is not the only vulnerable person on the road. We have to have a partnership with pedestrians and improve coexistence. This can be improved by the shape of the front of vehicles to improve the kinetics of impact with pedestrians. A major element is the hood ornament which should not resist impact but with the use of predetermined breaking points should be easily removed. Replacement is easy from our range.



see also chapter 18.2

Fast and convenient lifting and moving of your vehicle.
Dimensions: 880 x 620 x 305 mm. Max. load per dolly: 680 kg.
Max vehicle weight: 2720 kg. The car can be rotated 360°. Solid hard rubber wheels with ball bearings. Built in hydraulic provides easy lifting.

for wheels up to 305 mm Part no. 495672
for wheels up to 330 mm Part no. 495673

1. Simple hydraulic pump to press with your foot
2. The support rails slide together
3. The vehicle will be lifted easily

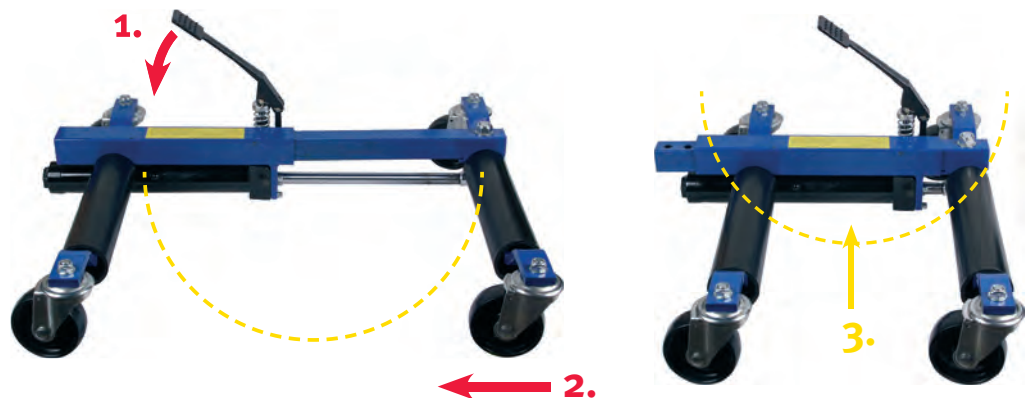

Warning: The rolles are very smooth so you should back up the whole thing with wedges. Especially if the parking area is not level.

2. SPECIAL CAR TOOLS

1. SPECIAL TOOL

for the variable valve timing

X308 3.2 and 4.0 from VIN...812317 to F59525
Part no. 220418



2. SPECIAL WRENCH

for front pulley locking. Must be combined with the appropriate adapter (ill. 3)

X308 3.2 and 4.0 from VIN...812317 to F59525
Part no. 217104



3. ADAPTOR

for pulley locking wrench 217104

X308 3.2 and 4.0 except Supercharged from VIN...812317 to F59525
Part no. 496693

X308 4.0 Supercharged from VIN...812317 to F59525
Part no. 496694



4. SPECIAL TOOL

for camshaft setting and locking

X308 3.2 and 4.0 from VIN...812317 to F59525
Qty. required: 2 Part no. 219421



5. SPECIAL TOOL

for the timing chain tensioners

X308 3.2 and 4.0 from VIN...812317 to F59525
Part no. 220385



6. WEDGE

for timing chains - supplied in pairs

X308 3.2 and 4.0 from VIN...812317 to F59525
Part no. 220387



7. SPECIAL TOOL

for crankshaft locking

X308 3.2 and 4.0 from VIN...812317 to F59525
Part no. 219475



7.

8. PULLER

for crankshaft pulley

X308 3.2 and 4.0 from VIN...812317 to F59525
Part no. 220396



8.

9. BALL JOINT SEPARATOR

for ball joints from 19 to 22 mm. Adjustable heavy duty type

X308 3.2 and 4.0 from VIN...812317 to F59525
Part no. 302057



9.

10. REMOVER

for front hub

X308 3.2 and 4.0 from VIN...812317 to F59525
Part no. 496696

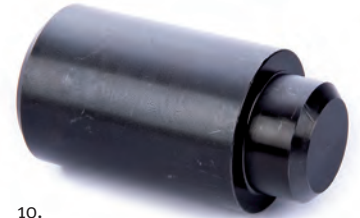

10.

11. PULLER

for rear hub

X308 3.2 and 4.0 from VIN...812317 to F59525
Part no. 272906



11.

12. PLIERS

for the removal and replacement of metal or plastic spring-loaded self-tightening hose clamps

X308 3.2 and 4.0 from VIN...812317 to F59525
Part no. 495853

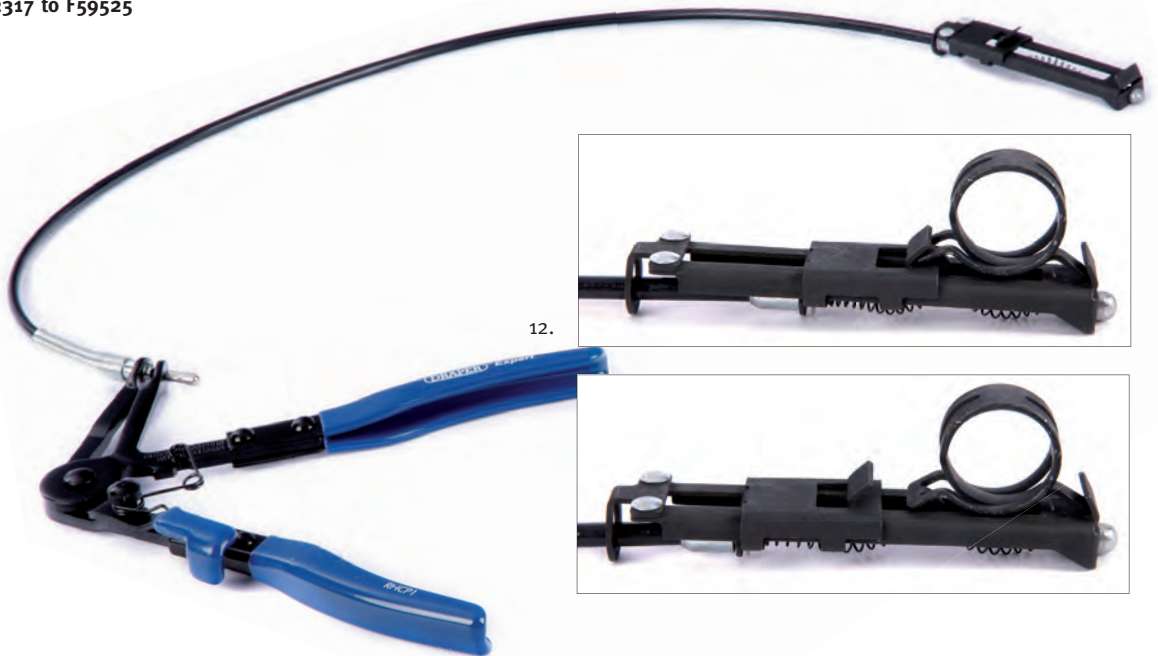

12.

13. PULLER

for ABS timing rotor

X308 3.2 and 4.0 from VIN...812317 to F59525
Part no. 220585



13.

3. WORKSHOP TOOLS

1. SOCKET SET

MM and AF

Draper Expert Hi-Torq™ sockets have 6 or 12 corners with a special radius design giving added torque. With this design Draper extends the life of the socket and fastener. These sockets have a hole for positive ball retention in accordance with DIN 3120 specification. Expert quality socket set manufactured from chrome vanadium steel hardened, tempered, chrome plated and polished for corrosion protection. Packed in blow mould carrying case and display.

- 41 piece. 1/2" square drive. . . . Part no. 311692
- 40 piece. 3/8" square drive . . . Part no. 306849
- 75 piece. 1/4" square drive . . . Part no. 214942



1.

2. GEAR WRENCH SET

Gear wrench open end with 15° offset, ratchet end with 180° flexible head and 5° ratchet mechanism. Chrome vanadium steel, hardened, chrome plated, polished

7 piece set with 10, 12, 13, 14, 15, 17 and 19 mm wrenches

Part no. 24487

10 piece set with 8, 10, 12, 13, 14, 15, 17 and 19 mm wrenches. As a special feature the wrenches can be converted to a 1/4" and 3/8" drive

Part no. 244338



2.



180° swivel head

5° = 1 click

3. COMBINATION SPANNER SET

Made from forged chrome vanadium steel. Comes with tool bag

11 piece set with 6, 7, 8, 9, 10, 11, 12, 13, 14, 17 and 19 mm wrenches

Part no. 218960

14 piece set with 8, 9, 10, 11, 12, 13, 14, 17, 19, 22, 24, 27, 30 and 32 mm wrenches

Part no. 319635



3.

4. COMBINATION SPANNER SET

Heavy duty edition, 1.5 times thicker as standard spanners to transport maximum torque!

13 pieces multi colour set with 6, 7, 8, 9, 10, 11, 12, 13, 14, 15, 16, 17 and 19 mm wrenches

Part no. 464592



4.

5. POCKET WRENCH

metric, 18 times adjustable from 8 to 25 mm

„Spring loaded adjustment, works like a pocket knife and allows the correct size to be used every time. Small enough to fit into your pocket, and packed in a sturdy material pouch. Special spacer blades lift into place for a snug fit that eliminates the play of most adjustable wrenches. 12 SAE sizes range from 5/16 to 1“; 18 metric sizes range from 8 to 25mm. Folds down to an incredible 5 x 2 x 3/4“. Ideal for: cars, boats, caravans, motorcycles, trucks and kitchen drawers“
Part no. 487863



6. SOCKETS

10 piece set from 13 to 24 mm. Fully polished and coloured mirror finish

Walldrive-system for 30% more torque! With this tool it's impossible to destroy or round screws and nuts. Rounded screws and nuts can be easily opened or fixed
Part no. 464593



7. TORQUE WRENCH

with 1/2" square drive, adjustable from 28 to 210 Nm, length: 465 mm, supplied with plastic box

Torque wrench with reversible ratchet head. The lb-ft and Nm scale is engraved on the barrel of the wrench. The micrometer type sleeve allows accurate preset torque values to be set. When torque is reached the wrench produces an audible click and a release of tension
Part no. 311625



8. TORQUE WRENCH

Adaptor, 40-200 Nm with 1/2" drive to use every ratchet or tee bar as torque wrench. Digital display, acoustic and optical signal when torque is reached
Part no. 490061



,Valve Devil'

9. LIMORA VALVE GRINDER

Good performance depends on properly seated valves. Badly seated or burnt valves and worn guides and stems result in hot gas escaping under compression reducing performance and increasing engine wear. Loss of power and poor starting are some of the symptoms. The Gunson EEzi-Lap oscillating valve lapper produces gas tight seals in seconds and converts a standard rotary drill to oscillating action/grinding motion. The 22/28 mm suction heads fit most valves, an essential tool for multi-valve engines
Part no. 321353



10. CHEMICO VALVE GRINDING PASTE

double ended tin with oil based grease and silicon carbide containing coarse and fine grades

110 g can
Part no. 489363



10.



Online Shop!
www.Limora.com



3. WORKSHOP TOOLS

11. NUT SPLITTER

with chromed surface
supplied in a 3 piece
set. From 9 to 22 mm
and from 3/8 to 7/8"
Part no. 317014



11.

Expert quality, manufactured from chrome
vanadium steel with square drive ends

from 9 to 12 mm. Length 80 mm
Part no. 328862

from 12 to 16 mm. Length 105 mm
Part no. 328863

from 16 to 22 mm. Length 130 mm
Part no. 328864

12. HAND TAP

supplied in a 10 piece metric set. Manufactured
from special high carbon steel with accurately cut
threads. Contents tabs from 3 to 12 mm
Part no. 287485



12.

13. MAGNET HOLDER

flexible. Length: 540 mm. The best one we could
find! Capable of lifting over 3 pounds
Part no. 371962



13.

14. GREASE GUN

New Patent! Taut spring supplies necessary pressure! Feeds grease automatically! The stable construction with extra-long handle creates an extremely high pressure. The grease will be pressed into every corner deep in the bearings. A new type of patent allows cartridge replacement without the annoying fat graffiti. The amount of grease which is still in the cartridge is always clear.
Part no. 220563



14.

15. GREASE

LZR 2 longlife grease is a new grease for roller and friction bearings, that is made from high quality basic oils by using lithium soaps as thickening agents. It shows an extraordinary oxidation resistance. LZR 2 grease is water resistant, adhesive, can be loaded with pressure and is protective against corrosion. These properties, in connection with high work resistance, very good abrasion rating and particularly strong adhesive quality, characterise this lubricant as particularly appropriate for lubrication under difficult operating conditions and at highly loaded roller and friction bearings.

Practical advantages: LZR 2 can be used universally as a long-term grease. It is recommended for lubrication of vehicles, industrial machinery and for all machines and devices in the field of construction, stone and earth. Temperature range: -30° to +120°C. 500 g cartridge
Part no. 305693



15.

16. IMPACT WRENCH

with 1/2" drive. Contents: ten impact nuts from 9 to 27 mm, one 5" extension bar, one mini oiler, one nipple. Tech. data: 6.3 bar operating pressure, 310 Nm maximal torque, 7.000 rpm free speed
Part no. 488134

17. SOCKET

46 mm for 1" drive - for the removal of ball joints
Part no. 493698



16.



17.

18. SOCKET

46 mm for 1" drive - for the removal of ball joints
Part no. 493700

19. TACHOMETER

digital gauge with laser RPM pick up. With 5 digit LCD-display and a measuring range from 2.5 up to 99,999 RPM, Accuracy: +/- 0.05% +1 RPM. The built in memory saves min. and max. RPM and the last measured value. With this special meter all rotating parts can be checked. Great diagnostic tool for gearbox, final drive and many other applications
Part no. 221361

18.



19.



20. THERMOMETER

Digital infrared thermometer with built-in laser pointer for exact measurement. Temperature range from -20 to + 520°C or -4 to 968° F. Accuracy: +/- 2° C or 2% of the reading. Response time: 500 mSec. Resolution: 0.2°. Now with an easy-to-use pistol design and illuminated display. Suitable for a lot of tasks around the car and workshop. Check the temperature of the engine, muffler, tyres and brakes. Which cylinder is getting hot? A fast detection of faulty components can save time and prevent expensive repairs and severe damage. 9V battery included
Part no. 306497

20.



21.



21. BATTERY

infrared thermometer 306497 (ill. 21)
Part no. 471684

22. MULTIMETER

digitally, shows: dwell, rpm, voltage, resistance, amps.
digital multimeter with a rotary switch for selection of the 24 different functions and ranges. Suitable for the measurement of DC volts and amps, resistance, dwell, rpm on 4, 6, 8 and 12-cylinder engines. The testing of diodes is also supported. The shock resistant housing is made of rubber. Supplied with 2 sets of cables: one pair with crocodile clamps and one pair with probes. A 9 V block battery and vinyl storage bag is included
Part no. 314833

22.



3. WORKSHOP TOOLS

23. SCREWDRIVER

170 mm long, with flexible shaft

- for 5 mm hose clips Part no. 245951
- for 6 mm hose clips Part no. 245955
- for 7 mm hose clips Part no. 245956
- for 8 mm hose clips Part no. 245957
- for 10 mm hose clips..... Part no. 246045



23.

24. LAMBDA SENSOR TESTER

with a fast 20 segment LED display covering a range from 0 to 1 volt. Suitable for cars with electronic fuel injection and catalytic converters. Also useful for testing the ECU injection control unit. Can be simply connected to the on board 12 volt battery with the 2 crocodile clamps. Prevents catalytic converter damage and provides an optimal fuel/air mixture

Part no. 245164



24.

25. LAMBDA SENSOR CHASER

for cleaning and restoring the sensor bore threads, M18 x 1.5 mm. Can be installed using spark plug wrench or 21 mm socket

Part no. 471256



25.

26. OIL FILTER WRENCH

universal, for oil filters from 53 mm to 118 mm

Part no. 301175



26.



Feldstraße 41
 D - 52070 Aachen
 Tel: +49 (0) 241 - 55 939 0
 Fax: +49 (0) 241 - 55 939 20
 E-Mail: Aachen@Limora.com

**Have you time to drop by?
 We look forward to seeing you.**

- Parts
- Tools
- Oil and grease
- Accessories
- Books
- Car care
- Consumables
- Seatbelts

**Amost 600 Square Metres.
 The first Limora Vintage store !**



1. PARKING SIGN

made from 18 gauge steel, with embossed ,Jaguar parking only' script in gold on green surface, size: 18 x 11.7/8"

Part no. 488717



1.

2. PARKING SIGN

made from 18 gauge steel, with embossed ,Jaguar parking only' script in white on red surface, size: 11.7/8 x 18"

Part no. 488721



2.

3. TYRE VALVE CAPS

chromed with marking to identify the the correct position of the wheel

Supplied in sets of 4.Part no. 493073

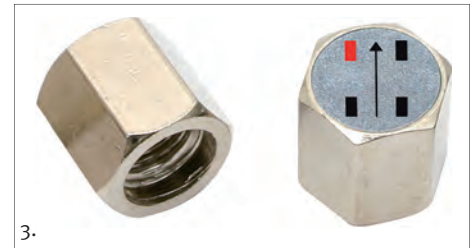

3.

4. TYRE VALVE CAPS

chromed with golden ,Jaguar leaping cat' on green surface

Supplied in sets of 4.Part no. 251195



4.

5. TYRE VALVE CAPS

chromed with white ,Jaguar' head on green surface

Supplied in sets of 4.Part no. 446790



5.

6. TYRE VALVE CAPS

chromed with Union Jack logo

Supplied in sets of 4.Part no. 478517



6.

7. JAGUAR TEDDY BEAR

in brown, with flying jacket, goggles and white T-shirt with red ,Jaguar' logo

Part no. 489083



7.

Secured against theft by simply tightening a screw on the side of the caps.
Allen wrench included!



4. ACCESSORIES

8. KEY FOB

with a silver XK logo against a black background. The silver keyring features Jaguar engraved into the ring

Part no. 496579



8.

9. KEY FOB

with a white Jaguar leaper logo against a black background. The silver keyring features Jaguar engraved into the ring

Part no. 496581



9.

10. KEY FOB

with a white Jaguar leaper logo against a black background. The silver keyring features Jaguar engraved into the ring

Part no. 327649



10.

11. JAGUAR KEY FOB

with chromed 'Jaguar' Logo on black surface, supplied with a drawstring pouch

Part no. 489072



11.

12. KEY FOB

'Jaguar' head, black leather, 40 mm x 85 mm

Part no. 356383



12.

13. KEY FOB

'Jaguar' Leaping Cat', black leather, 40 mm x 85 mm

Part no. 206848



13.

13. COFFEE MUG

in white with 'Jaguar Leaping Cat' logo in black

Part no. 272413



14.

15. UMBRELLA

with a 130 cm span when fully open, colour: black. Made from lightweight aluminium. The white Jaguar logo has been printed on alternate panels

Part no. 318709



15.

16. UMBRELLA

with a 130 cm span when fully open, colour: white/black. Made from lightweight aluminium. The red Jaguar Heritage logo has been printed on alternate panels

Part no. 490376



16.

17. CAR COVER

Our Car covers are made from high quality materials to ensure that your quality expectations will always be met and surpassed. We use the latest generation materials, double stitching, durable securing straps and purpose made fittings. We have a wide range of cover materials available. There is a blue indoor cover available and a heavy duty grey outdoor cover. The breathable indoor dust cover is manufactured from a thick non-woven material in a royal blue colour. It is breathable and 100% UV resistant to protect paintwork and prevent colour fade and comes with elasticated hems and underbody straps for a snug fit. This type of car cover will not deposit fluff on mohair or canvas hooding material and is both machine and hand washable. The heavy duty outdoor cover comes with a soft lining to protect paintwork. It is a substantial cover weighing about 3 kg and packed in a sturdy zipped storage bag with handles. The grey coloured outer skin is soft and pliable, yet totally waterproof, and the stitched seams are heat sealed. Of course you can order your free colour sample: 491710 (blue) and 355026 (grey)

grey (outdoor)

**X308 3.2 and 4.0 SWB models
from VIN...812317 to F59525**
Part no. 318064

blue (indoor)

**X308 3.2 and 4.0 SWB models
from VIN...812317 to F59525**
Part no. 496877

grey (outdoor)

**X308 3.2 and 4.0 LWB models
from VIN...812317 to F59525**
Part no. 496876

blue (indoor)

**X308 3.2 and 4.0 LWB models
from VIN...812317 to F59525**
Part no. 496878

OF COURSE YOU CAN ORDER COLOUR SAMPLES FOR FREE UNDER FOLLOWING PART NUMBERS:

COLOUR SAMPLE

for indoor car cover
in blue
Part no. 491710

for outdoor car cover
in grey
Part no. 355026



17.

4. ACCESSORIES

18. CAR COVER

with Union Jack motive. Indoor cover made from a soft material like sweat shirt material. Useable for any car around 15,5 ft. in length

X308 3.2 and 4.0 from VIN...812317 to F59525
Part no. 489281



18.

19. DUSTER

made of 100 % soft cotton. Lifts dust without scratching the paint. Expandable plastic grip

Part no. 318723



19.

20. DUSTER

made of 100 % soft cotton. Lifts dust without scratching the paint. Comes with robust wooden grip

Part no. 493332



20.

21. LIQUID WAX

for re-impregnation of car dusters that have become dry

100 ml pump sprayer Part no. 493311



21.



19.

22. OIL BINDING MAT

sizes: 90 x 120 cm, oil consumption: 4 litre

This mat shields and protects garage floors and work surfaces. It soaks up months of drips and spills without looking messy or spoiling the floor underneath. It will not rip or tear, even when saturated. This oil drip mat comes complete with a poly backing rug, which provides a non-slip interface with the floor and does not allow liquids to penetrate or stain the floor. Cuts easily to shape for multiple uses; tool boxes, shelves, workbenches, and vehicles.

Part no. 355878



22.

23. STOOL

with Union Jack print, connector system made of robust plywood, dimensions: 42 x 29,5 x 29,5 cm, stool load: 150 kg

Part no. 496486

Is your stool still cool?

Always new, always surprising, always different – unexpected things do not miss out but getting into the spotlight: The Werkhaus PHOTOHOCKER! Stable wood-based panels (MDF), furnished with high-resolution digitalprints and protected by an UV-hardening lacquer, connecting themselves trough the original Werkhaus connection-system to a durable seating furniture.



23.

Incocnito travel bags

The „incocnito“ series is inspired by the opening mechanism of those old doctor's cases. It is technically innovative, doing away with the heavy and elaborate opening frames, and fulfills its tasks with bravado. With its simple elegance, the incocnito range is made for people who prefer understatement: The bag comes in the sizes „weekender“, „business“ and „upend“. Material: ultralight, high quality South American cowhide or oiled and waxed „nature-look“ cowhide. 1 main compartment with zipper, 2 tenax safety buckles, 1 zipper pocket outside, 2 pockets inside, 2 handles and 1 shoulder strap.

24. TRAVEL BAG

buisness model

Outside material: brown cotton with leather details in dark brown. inside material: dark brown cotton with leather details. Size: 40 x 30 x 14 cm
Part no. 497770

25. TRAVEL BAG

weekender model

Outside material: black cotton with leather details in black. inside material: black cotton with leather details. Size: 45 x 26 x 23 cm
Part no. 497769



24.



25.



Online Shop!
www.Limora.com



4. ACCESSORIES

26. LETTER OPENER

with chromed ,Leaping Cat' motif, length: 183 mm

Part no. 492860



26.

28. BOTTLE OPENER

with chromed ,Leaping Cat' motif, size: 75 x 15 x 15 mm, weight: 40 g

Part no. 489076



28.

27. BOTTLE OPENER

with chromed ,Leaping Cat' head. Size: 90 x 65 x 65 mm, weight: 550 g

Part no. 490288



27.

29. CORKSCREW

Leaping Cat, polished chrome, size: 120 x 90 mm

This elegant corkscrew is crafted from a leaper motif, an ideal gift for any Jaguar enthusiast
Part no. 485558



29.

31. PAPERWEIGHT

with chromed ,Leaping Cat' motif on finest wooden mahogany socket, length: 125 mm

Part no. 318128



31.

30. PAPERWEIGHT

with chromed ,Leaping Cat' motif on chromed base

length: 80 mm Part no. 485562

length: 140 mm Part no. 485556



30.

32. DECANTER

with chromed ,Leaping Cat' motif on polished ,SS100' style radiator grille, height: 190 mm

Best.-Nr. 485557

This chrome decanter with wire mesh grille is the perfect gift for that car enthusiast in your life. This model was made after careful study of the original and was fitted with the Leaping Jaguar mascot, 19cm high, complete with original card box.



32.

33. BASEBALL CAP

with Jaguar script. Made from polyester, colour: black with contrast white line around the fabric covered peak

Part no. 493848



33.

34. BASEBALL CAP

with white Jaguar logo. Made from polyester colour: green with contrast white line around the fabric covered peak

Part no. 318708



34.

35. BASEBALL CAP

with white Jaguar logo. Made from polyester, colour: black with contrast white line around the fabric covered peak

Part no. 272338



35.

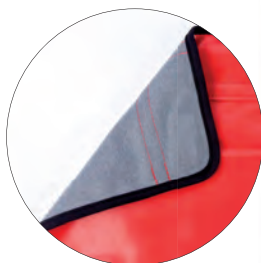

36. WING COVER

green padded and emblazoned with the leaping cat. Size: 90 x 50 cm

Made from nylon, washable. Doesn't scratch paintwork because of supersoft anti-slip surface on underside. No magnets inside.

Part no. 487962

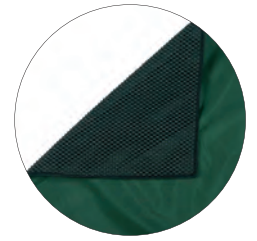

36.

37. WING COVER

green padded and emblazoned with the leaping cat. Size: 90 x 55 cm

Part no. 317948



37.

38. WING COVER

made of soft red cotton cloth. The built in magnets fix the cover to the wing. Suitable for use with any vehicle. Protection against dirt and scratches. Size: 100 x 57 cm

Part no. 318071



38.



4. ACCESSORIES

39. SEAT COVER

green padded and emblazoned with white leaping cat. Size: 130 x 75 cm, nylon-fabric, washable. British racing green, protects seats from dirty working clothes

Part no. 487963



39.

40. LUSTER LACE POLISHING STRIPS

Luster Lace polish strips are designed to work on all round and tubular metal surfaces. The polish is in the cloth of the strips, no other utilities are needed to get the perfect finish. Luster Lace is fast and easy to use with 360° polishing power that can't be bettered. So now you can save up to 70 % of your work time. Luster Lace comes in three convenient sizes (narrow, medium, wide) for the care of parts of all sizes.

- Luster Lace Narrow - for wire wheels and filigree parts
- Luster Lace Medium - for headlamp rims, tubular manifolds etc.
- Luster Lace Wide - for large diameters like silencers
- Luster Lace Combo - complete assortment, for all parts

,narrow'

Content: 14 strips 1/2" wide
Part no. 485441

,medium'

Contents: 9 strips 25/32" wide
Part no. 227633

,wide'

Contents: 6 strips 1.3/16" wide
Part no. 378882

,combo'

Content: 4 strips 1/2" wide, 3 strips 3/4" wide and 2 strips 1.1/4" wide
Part no. 485440



40.

41. USB MEMORY STICK

4 GB, as Classic Jaguar E-Type shape model in silver

Part no. 496583



41.



42. JAGUAR BALLPOINT PEN

in a black leather case with subtle blue stitching
Part no. 493847



42.

44. NET POCKET

for boot area - for maps, gloves, etc.
Size: 32 x 14 cm
Part no. 494474



44.



43. PRYMOS® FIRE EXTINGUISHER SPRAY

„Auto & Bike“, AB foam against early stage fire.
The extinguishing capability is (21B/3A)

580 ml aerosol. Part no. 494103
Prymos Fire Extinguisher Spray is designed for extinguishing fires in cars, in truck cabs, mobile homes as well as motorcycles and can be used with electrical appliances charged up to 1000 volts. It can be carried in the car or stored in the garage at temperatures from -15 °C to +60 °C max. Applications: tires, trailers, motors, polymers, liquid fuels, paper and cardboard.



43.

4. ACCESSORIES

45. SWISSVAX MASTER COLLECTION

The Swissvax Master Collection is the ultimate combination of convenience and practicality. Leather seats, wood, plastics, vinyl, wheels, tyres, chrome, brass, nickel, glass ... the Master Collection will enhance every detail of your automobile to stunning and perfect Concourse standard. Includes: Cleaner Fluid (pre-wax treatment) 250 ml, Cleaner Fluid medium (scratch remover) 250 ml, Paint Rubber (clay bar), Quick Finish (quick detailing fluid) 250 ml, Car Bath (wash concentrate) 250 ml, Wheel (wheel cleaning concentrate) 250 ml, Mixing Bottle (spray bottle) 250 ml, Micro-Wash microfibre, Pneu (tyre dressing) 250 ml, Protecton (plastic restorer) 250 ml, Leather Cleaner 250 ml, Leather Milk 250 ml, Leather Cleaning brush, Metal Polish (chrome, aluminum) 50 ml, Wood Polish 50 ml, Autobahn wheel wax with PTFE 50 ml, Crystal (glass cleaner) 250 ml, 2 applicators (for wax and Cleaner Fluid), 3 towels, MicroPolish microfibre towel (blue), special brushes, Swissvax handbook, Cooler-Bag to insulate from high temperatures with variable dividers. Please combine the Master Collection with the wax of your choice.

with English labelling
Part no. 330012

with German labelling
Part no. 487054



45.

Please order the the Swizoil wax of your choice to complete your Entry Collection Set separate

46. SWISSVAX ONYX WAX

Swissvax Standard wax. The perfectly balanced oil concentration prevents hazing, produces a brilliant, streak free gloss. 30 Vol. % of pure yellow Grade One Brazilian carnauba wax gives colours protection from scratches caused by dust and washing. Use after applying Cleaner Fluid. Enough for approx. 30 wax treatments of a sedan.

with German labelling
Part no. 487060

with English labelling
Part no. 329961



46.

47. SWISSVAX MIRAGE WAX

Swissvax Premium wax for all colours. Contains a high concentration of ultra pure Brazilian grade one carnauba (over 40 % by volume) and is enriched with coconut and avocado oil extracts. Mirage is an excellent choice for an enhanced shine and a varnish protection making a longer impression. Produces a brilliant streak-free gloss. Use after applying Cleaner Fluid. Enough for approx. 20 wax treatments of a sedan.

with German labelling
Part no. 487061

with English labelling
Part no. 329971



47.

48. SWISSVAX CONCORSO WAX

The most famous Swissvax special wax for deeply reflecting and repletely shiny surfaces. Applying Concorso wax will lead to a breathtaking effect due to 50 Vol. % of pure, yellow Brazilian Grade One carnauba. Use after applying Cleaner Fluid. Enough for approx. 20 wax treatments of a sedan.

with German labelling
Part no. 487062

with English labelling
Part no. 329972



48.

Autosol® - The entire world of car care

A brilliant idea formed the basis on which Otto Durst laid the foundation stone for our successful business in 1929. He developed a chrome cleaner that still gives splendid gleaming results today.

In order to guarantee your 100% satisfaction Dursol uses only first-class materials from leading suppliers.

Today Durosol produce and distribute a full range of cleaning and care products for automobiles, as well as for industrial, commercial, private and trade use. Durosol comply with the strictest manufacturing regulations in order to meet the quality standard we have set in our company.

The Dursol factory operates on an international scale. Many of their products have been awarded Gold Medals by the independent consumer testing organisation "Monde Selection" from Brussels in Belgium.

49. AUTOSOL® PLASTIC PROTECTION & CARE KIT

complete set to revive plastic surfaces. Contents: 75 ml cleaner, 200 ml plastic care and a microfiber cloth

Part no. 497959

Autosol® Plastic Cleaner effortlessly and thoroughly clean both indoor and outdoor plastic surfaces. This easy to apply paste removes nicotine stains, shoe scuff marks, and gives a new gloss finish to tired surfaces. Autosol® Plastic Care provides a protective film that protects from brittleness, graying and ageing while its deep conditioning formula creates a silk matt finish.



49.

50. AUTOSOL® LEATHER CARE KIT

complete set to revive leather and vinyl surfaces. Contents: 75 ml cleaner, 200 ml leather care and a microfiber cloth

Part no. 497494

Easy to dispense leather cleaning paste cleans thoroughly and freshes up natural, vinyl, synthetic leathers. Increases depth of colours and elasticity while creating a matt shine. Thanks to an improved recipe, the leather care emulsion leaves a protection layer that prevents brittleness and abrasion, but allows leather to breathe. High quality oils preserve the leather's natural characteristics.

Note: Not suitable for suede.



50.

51. AUTOSOL® NANO PROTECTION METAL CARE KIT

complete set to clean and protect metal surfaces. Contents: 75 ml cleaner, 100 ml care and a microfiber cloth

Part no. 497957

Autosol® Nano metal polish cleans thoroughly. Special high performance polishing particles prepare the surface for sealing with Autosol® Nano Metal Guard. Synthetic waxes and components seal with a thin protective layer and give the surface increased protection from environmental influences.



51.



Online Shop!
www.Limora.com



Sonax

53. SONAX PREMIUMCLASS PAINT CLEANER

to prepare the paintwork for a subsequent sealing. Contents: 250 ml cleaner with a sponge for application and a high-quality microfibre cloth for a perfect finish

Part no. 488880

Ideally prepares the paintwork for a follow-up sealing. Degreases the paintwork and removes greasy films caused by silicone, oil and wax deposits. Removes fine scratches, smoothens the paintwork and intensifies the shine. The durability of a follow-up paintwork sealing is significantly improved. Also ideal for preparing the undercoat for respraying, or for sticking on adhesive foils.



53.

54. SONAX PREMIUMCLASS CARNAUBACARE

high quality wax for new and nearly new paintwork. Contents: 200 ml carnauba wax, a sponge for application and a high-quality microfibre cloth for a perfect finish

200 ml can. Part no. 488879

High quality protectant for new and nearly new paintwork. Protects against adverse weather and other environmental hazards, reduces adhesion of insects. Visible water run off effect. The highly concentrated carnauba wax maintains the paint lacquer and provides a dazzling high gloss. The new formula is easily polished out without leaving greasy streaks.



54.

56. PREMIUMCLASS NANO PAINT SEAL

for an optimal drip-off effect testifies to great paintwork protection. Contents: 250 ml paint cleaner, 75 ml paint coating, an application sponge and two microfibre clothes

Part no. 488884

Nano-technology based long-lasting sealant for paintwork or painted plastic components. The paintwork is protected by a coating of modified fluorocarbon nano-particles, which are as hard as glass. It freshens up the colours intensively, has a dirt repellent effect, and has an outstanding-droplet run off effect. Depending on conditions, provides protection for up to 9 months.

55. SONAX PREMIUMCLASS SAPHIR POWER POLISH SET

high end polish on Nano-Saphir base. Contents: 250 ml polish, a special Sonax P-Ball with sponge as well as a high quality microfibre cloth

Part no. 496668

High-End polishing technology based on nano sapphires for paintwork of all types and conditions. The polish completely removes even the finest scratches, wears away weathered paint layers and really freshens up dull colours. It produces a perfect paintwork finish and a very even deep shine, and because it optimally smoothens out the paintwork, it will outlast many washes. It enables a perfect polishing result free from holograms, streaks and clouds, and will also remove any existing holograms. In addition, the product contains Carnauba wax which provides fundamental protection to the treated paintwork surfaces.



55.



56.

Victoria

57. VICTORIA® COLLECTION OF CARE PRODUCTS

No. 1. 12-piece selection of quality care products in a beautiful, classic metal box

Part no. 489886

Everything needed for an optimal care of your automobile in just one metal box. It does not only look very good with its nostalgic design but is also extremely convenient: The VICTORIA® Care Box contains all indispensable products for the maintenance of your automobile. Content: 250 ml Paint Renovation, 250 ml Paint Polish, 250 ml Paint Protection, 125 ml Leather Care, 50 ml Aluminium Polish, 50 ml Chrome Polish, 50 ml Hand Cleaning Paste, 65 ml Rubber Care, 1 Micro Wash Cloth, 2 Polishing Sponges, 1 Micro Care Glove.



57.

58. VICTORIA® COLLECTION OF CARE PRODUCTS

No. 2. Three products for your car care in classic design metal case

Part no. 489887

The set of care products for every automobile-enthusiast. It is nice and convenient at the same time. The VICTORIA® Metal box No. 2 is equipped with valuable products out of the VICTORIA® selection of care products. Content: 250 ml Gloss, 50 ml Chrome Polish and a Professional Microfiber Cloth



58.

59. WRINGER

for chamois and towels. Heavy duty steel construction, nearly indestructible. Removes 90% of the water. Cylinder width: 30 cm

Part no. 290337

60. CHAMOIS

2.5 sqf. Finest chamois leather, 100% oil tanned approx. 38 x 59 cm. Part no. 292546
approx. 45 x 70 cm. Part no. 292581



59.

60.

5. BOOKS

1. JAGUAR

The complete chronicle from 1922 till today. Written by Heiner Stertkamp, 420 pages with 1.000 coloured illustrations, size: 280 x 280 mm, binding: hardcover

This is the first book to combine exhaustive research about the vehicles and a full history of the company in one volume - everything from different machines, models, racing drivers, wins and losses on the racetrack, production, plus an extensive specifications index. Heiner Stertkamp is a renowned Jaguar expert and enthusiast, and has enjoyed full access to the Jaguar Daimler Heritage Trust archives in writing this book. This makes it the most complete, detailed history of Jaguar today, a book sure to become a classic and received warmly by any interested reader, taking pride of place on their bookshelves.

English Part no. 496445
German Part no. 437021



1.

2. JAGUAR

All the cars. Written by Nigel Thorley, 320 pages with 500 coloured illustrations, size: 233 x 169 mm, binding: hardcover

This extensively researched guide provides exhaustive reference detail for all post-war Jaguar models, supported by facts, figures and photographs, from the Mark V saloon through to the latest X-Type, S-Type, XK and XJ models. Information provided includes technical specifications, production changes, chassis numbers, production quantities, colour schemes, options and accessories. For ease of reference, each model is dealt with in a separate chapter, and all information is presented in clear tabular form. Here is a definitive reference work for enthusiasts, those looking to buy a Jaguar and anyone with a general interest in the marque.

English Part no. 492789
German Part no. 495762

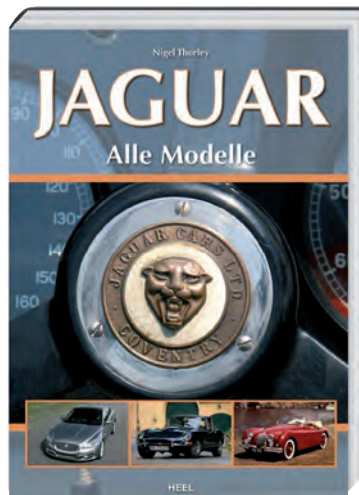

2.

3. JAGUAR

The impressive portrait of Jaguar marque. Written by Bernard Viart and Serge Bellu, photos by Xavier de Nombel, 208 pages with 223 coloured and 28 b/w illustrations, size: 300 x 240 mm, binding: hardcover, language: German

The authors Viart and Bellu describe in this book the history of Jaguar. More than 100 types and 34 models are portrayed in words and pictures. They fit together to form a complete picture of the car brand.

The authors describe in great detail how each model is developed historically and how it is technically and aesthetically advanced. What proportion of the individual managers, engineers, technicians and designers had is discussed in detail. The authors also tell the often incredibly complex history of these individual vehicles. Special consideration is given to the ultimate Jaguar XK and the development of the V12 engine. The racing history of Jaguar is presented in detail. Part no. 495737



3.

Our new catalogues! Now with online ordering function!

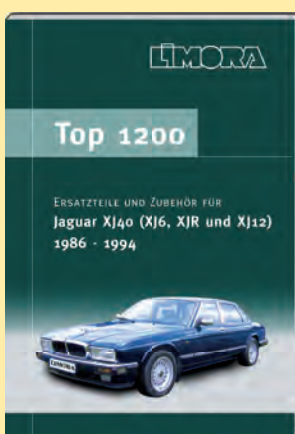

English Part no. 293080
German Part no. 343299
French Part no. 499191



English Part no. 497252
German Part no. 497251
French Part no. 497253



English Part no. 496826
German Part no. 493838
French Part no. 496827

Order
by Smartphone



4. TYPE GUIDE

Jaguar cars since 1931.

Written by Halwart Schrader, 128 pages with many photos, size: 205 x 140 mm, binding: paperback, language: German

The cats from Coventry are more successful than ever. This success was initiated by the change of the S-Type in 1996 but the roots of success lie in the distant past from the first Jaguar in 1931. Halwart Schrader has produced a comprehensive but concise treatment of the entire range of sports cars, coupes, saloons and convertibles. Part no. 486391

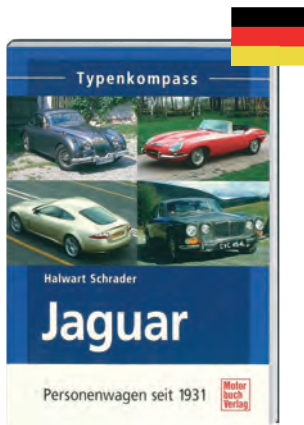

4.

5. JAGUAR XJ

and all models since 1922.

Written by Jürgen Zöllter und Martin G. Puthz, 160 pages with 143 illustrations, size: 230 x 265 mm, binding: hardcover, language: German

It is the exceptional beauty and the sometimes nostalgic design, known as the Jaguar unique brand, a very British style. The Jaguar XJ with its unique design has always been the top model among the Jaguar saloons. The new model, the XJ series is, however, a stylistic coup, as has been achieved often in the Jaguar brand history. This book presents the new Jaguar Luxury saloon in an impressive series of photos taking the reader through the rugged Welsh landscape to the places where testing of the new XJ was carried out. There are affectionate portraits of the originators of the new XJ: designer Ian Callum and development director Malcolm Sandford. There are also detailed design sketches and wonderful photographs providing the the reader with insights into the development process of the new British cat from Blackpool. Jaguar XJ - a new dimension to the story is about design and technical expertise from Britain. The new XJ forms the core of the book, and at the same time there is a compact overview of all Models from past to present. The book like the new XJ is a balancing act between traditional and modern.

Part no. 491722



5.

7. ESSENTIAL BUYER'S GUIDE

Jaguar/Daimler XJ from 1994 to 2003. Written by Peter Crespin, 64 pages, with 100 illustrations, size: 270 x 210 mm, binding: paperback, language: English

The X300 was the first serious model development in collaboration with Ford and the cars benefited in quality terms as a result. Problems do exist, however, especially with the X308 models which followed in 1997. Though they are excellent value today, it is still important to buy the right car if expensive problems are to be avoided.

This book will help you decide which car to consider and having chosen your model it will help pick a sound car from amongst those you locate and inspect. High mileage need not be a deterrent but you need to avoid neglected cars and know exactly what to look for. This book ensures you have the insight and expertise to select the best example within your budget. Each aspect of the vehicles is given an objective numerical score reflecting the car's condition. These are added to give an overall score supporting a decision to buy or leave. There is no safer way to avoid buying a bad car short of paying for a professional evaluation. This book will pay for itself.

Models covered:

Jaguar XJ6 and Sovereign (X300) 3.2 (1994-1997) • Jaguar XJ6 and Sovereign (X300) 4.0 (1994-1997) • Daimler Six (X300) 4.0 (1994-1997) • Jaguar XJR6 (X300) 4.0 (1994-1997) • Jaguar XJ12 (X300) 6.0 (1994-1997) • Daimler Double Six (X300) 6.0 (1994-1997) • Jaguar XJ8 and Sovereign (X308) 3.2 (1997-2003) • Jaguar XJ8 and Sovereign (X308) 4.0 (1997-2003) • Jaguar XJR8 (X308) 4.0 (1997-2003) • Daimler V8 (X308) 4.0 (1997-2003) • Daimler Super V8 (X308) 4.0 (1997-2003)

Part no. 496446

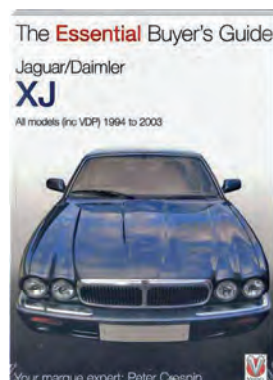

7.

6. DAS GROSSE BUCH DER FAHRZEUGPFLEGE

written by Christian Petzoldt, 196 pages with 600 coloured illustrations, size: 270 x 210 mm, binding: paperback, language: German

Whether new or used, whether vintage, Classic cars or convertible - this book is tuned to the specific characteristics of each vehicle. Cleaning and maintenance plays a prominent role in maintaining the optimal value of a car. The proper handling of painted surfaces, plastics in exterior and interior trim, chrome parts, upholstery, leather upholstery, wood trim and different roof cover materials for convertibles require the expert use of matching chemical aids, work utensils and especially techniques to achieve convincing results. All of these aspects are discussed in detail in this extensively illustrated book. It provides concentrated experience and all the expertise of a established industry expert, enriched with numerous professional tips from years of work experience. An indispensable guide for all car lovers.

Part no. 491469



6.

For a wide range of international books

look at

[www.scparts.](http://www.scparts.co.uk)

[co.uk](http://www.scparts.co.uk)



Jaguar's recommendation for:

X308 3.2 and 4.0 from VIN...812317 to F59525

25. CASTROL FULL SYNTHETIC OIL
Edge SAE 0W/40
5 litre canister . . . Part no. 496772

Castrol EDGE 0W-40 A3/B4 gives you the confidence to demand maximum engine performance from today's modern, higher revving sports, performance and luxury vehicles requiring lower viscosity higher performance oils.

Product benefits:

- Helps to maximise short and long term engine performance
- Improves engine efficiency, independently tested
- Delivers excellent levels of protection across a variety of driving conditions and temperatures
- Reduces engine deposits to help maximise engine response

Technical specifications and approvals:

- SAE 0W-40,
- ACEA A3/B3,
- A3/B4,
- API SN/CF
- VW 502 00/ 505 00
- BMW Longlife-01
- MB-approved 229.3/ 229.5
- Porsche A40
- Suits Ford WSS -M2C937-A
- Peugeot B71 2296

26. CASTROL FULL SYNTHETIC OIL
Magnetec SAE 5W/30 C3
5 litre canister . . . Part no. 472241

Castrol Magnetec 5W-30 A3/B4 intelligent molecules cling to critical engine parts to provide an extra layer of protection. With up to 75% of engine wear happening whilst your engine's warming up, Castrol Magnetec's molecules are always there, always ready, drastically reducing engine wear during this critical start-up and warm-up period. Castrol Magnetec 5W-30 A3/B4 combining Intelligent Molecules and fully synthetic technology: Clings to your engine forming an extra layer that protects during warm-up and beyond. Bonds to metal surfaces making engine parts more resistant to wear. Combine with synthetic technology to provide increased protection in high and low temperature applications.

Technical specifications and approvals:

- API SM/CF
- ACEA A3/B3, A3/B4, C3
- GM-LL-A-025
- GM-LL-B-025
- BMW approval Longlife-01
- MB approval 229.31
- RENAULT approval RN0700
- VW approval 502 00 u. 505 00
- FIAT approval 9.55535-G1
- JAGUAR approval WSS-M2C913-B

27. CASTROL FULL SYNTHETIC OIL
Magnetec SAE 10W/40 A3/B4
5 litre canister . . . Part no. 472236

Castrol Magnetec combines Intelligent Molecules with part synthetic technology to instantly protect, from the moment you turn the key.

Product benefits:

- Clings to your engine forming an extra layer that protects during warm-up and beyond
- Bonds to metal surfaces making engine parts more resistant to wear
- Provide protection for all driving conditions and styles

Technical specifications and approvals:

- ACEA A1/B1
- API SL
- Meets Ford WSS-M2C925-A and Ford WSS-M2C925-B
- Meets engine test requirements of A5/B5
- ILSAC GF-3

28. CASTROL ENGINE OIL
GTX 10W-40 with HC-synthetic base oils
5 litre canister . . . Part no. 472186

The Castrol GTX product range features lubricants for vehicles with proven engine technology and provides a balanced performance under all types of conditions. In addition, GTX High Mileage A3/B3 is a product which was designed especially for engines with a mileage of over 70.000 miles (100.000 km). Protect your car from harmful sludge with Castrol GTX 10W-40 A3/B4 which contains anti-sludge formula that provides 25% better sludge protection compared to tough industry standards. Castrol GTX provides 25% better protection against sludge than the latest industry standard. Liquid Engineering protects against problems that your engine faces every day.

Product benefits:

vs API SL &/or ACEA A3/B4 Industry standards

Technical specifications and approvals:

- API SL/CF
- ACEA A3/B4
- VW 501 01/505 00
- MB-approval 229.1
- Fiat 9.55535.D2



capacity motor oil: 6.5 litre, or 7.5 litre with oil cooler

6. OILS, LUBRICANTS, FLUIDS AND ADDITIVES

5. AUTOMATIC GEARBOX OIL

X308 4.0 Supercharged
from VIN...812317 to F59525
 1 litre bottle Part no. 348154

gearbox oil capacity: **10 litres**



5.

6. AUTOMATIC GEARBOX OIL

X308 3.2 and 4.0 except Supercharged
from VIN...812317 to F59525
 1 litre bottle Part no. 421900

gearbox oil capacity: **10 litres**



6.

7. JAGUAR ANTI-FREEZE COOLANT radiator. Specification: DOW D542

X308 3.2 and 4.0
from VIN...812317 to VIN...F00034
 1 litre bottle Part no. 422089

cooling system capacity: **10 litres**



7.

8. JAGUAR ANTI-FREEZE COOLANT radiator. Spezifikation: WSS M97B44-D

X308 3.2 and 4.0 from VIN...F00035 to F59525
 1 litre bottle Part no. 422635

cooling system capacity: **10 litres**



8.

9. WAGNER ADDITIVE

Bactofin - fuel stabilizer, specially for fuels with Bio-Ethanol (E10). Dosage: 1:1000

100 ml bottle Part no. 494084
 300 ml bottle Part no. 494085
 1 litre bottle Part no. 494086

Modern fuels attack the metal parts of the fuel supply systems. This problem applies especially to older vehicles, while in modern cars, for good reasons, more and more plastic tanks are used. The second problem relates to biogenic fuels and mixed fuels. This problem applies to owners of all ages of cars and modern cars too. In modern fuels bacteria grow in unprecedented quantities. This produces a lot of dirt, especially when the vehicle is not in regular use. The pipes gradually get blocked and the tank becomes contaminated with dirt. Rather than the drastic measure of replacing the entire fuel supply system, regular use of Bactofin will reduce the problem considerably. For vehicles which normally operate with lead-replacement or top oil, using Bactofin is just as easy and will give owners peace of mind. Bactofin also prevents any corrosion of the fuel system. Rust is completely inhibited!



9.

10. CASTROL AUTOMATIC GEARBOX OIL

Transmax Dex III for power steering - replaces TQ Dexron III

X308 3.2 and 4.0 from VIN...812317 to F59525
 Transmax Dex III is a high quality mineral based automatic transmission fluid, recommended for most passenger cars where a product to GM Dexron III, Ford Mercon 94 or Allison C4 is recommended. Our recommendation for GM automatic gearboxes from 1993 onwards.
 1 litre bottle Part no. 217068

automatic gearbox capacity: **1 litre**



10.

6. OILS, LUBRICANTS, FLUIDS AND ADDITIVES

11. CASTROL GEAR OIL

SAE 75W/140

X308 3.2 and 4.0 from VIN...812317 to F59525
1 litre bottle Part no. 472147

Castrol Syntrox Limited Slip 75W/140 (Formerly SAF-XJ 75W/140) is a fully synthetic SAE 75W/140 hypoid gear oil formulated for use in both conventional and limited slip differentials.

Whilst being suitable for all applications where a lubricant of this quality is specified it is specially formulated for use in limited slip differentials fitted to Japanese vehicles requiring an SAE 75W/140 Extreme Pressure Gear Oil. Castrol Syntrox Limited Slip 75W/140 has additionally demonstrated outstanding performance in competition vehicles employing limited slip differentials.

Castrol Syntrox Limited Slip 75W/140 is also specifically designed for BMW differentials including the Z3 limited slip differential.

Benefits of Castrol Syntrox Limited Slip 75W/140

- Excellent shear stability.
- Exceptional resistance to oxidation.
- Particularly effective resistance to very strong loads.
- Very good low temperature fluidity properties.
- Affords increased drain intervals.
- Helps prevent vibrations / noise occurring in the transmission.

Specifications and manufacturer approvals:

- API GL-5
- ZF TE-ML-05D, 12D, 16G
- US claims - MIL-L-2105D
- BMW approved (for limited slip)

differential capacity: **2 litres**



11.

12. CASTROL BRAKE FLUID

React Performance DOT 4

X308 3.2 and 4.0 from VIN...812317 to F59525
1 litre bottle Part no. 472095

Castrol React Performance DOT 4 is a high boiling point polyglycol type brake fluid designed to provide superior braking performance in a variety of vehicles, especially those that operate at higher temperatures or under increased loads. The product has been formulated to give outstanding system protection against corrosion and high temperature vapour lock. Castrol React Performance DOT 4 is suitable for use in all brake fluid systems in cars, motorcycles and light commercial vehicles requiring either a DOT 3, DOT 4 or Super DOT 4 product (excluding where a mineral oil based fluid is specified). Castrol React Performance DOT 4 can be used with either disc or drum brakes, including modern vehicles fitted with ABS systems. The product is also suitable for use in hydraulic clutch systems.

Product features and benefits:

- High boiling point - exceeds US FMVSS DOT 3 and DOT 4 specification requirements, and offers a performance reserve over brake fluids with lower boiling points.
- High vapour lock temperature - greater protection against brake fluid vaporization.
- Corrosion protection - outstanding protection against corrosion caused by absorbed moisture, that can contribute to lower maintenance costs.
- High temperature stability provides a greater margin for safety because product performance will not fade under higher temperatures.

Response:

- Controlled viscosity requirements - under extremes of temperature and operating conditions, Castrol Response Super DOT 4 will maintain an optimum operating viscosity to ensure greater safety.
- Rubber swell control - contributes to efficient operation of the braking system components.
- Compatible with all other brake fluids that meet either DOT 3, DOT 4 or Super DOT 4 specification.



12.

13. CW 1:100 @ SCREEN TREATMENT

removes blinding, oily films with greatest economy - 1:200 concentrate with dosage head.
250 ml bottle Part no. 492763

The economy of CW 1:100 Classic is unbeatable. One 250 ml bottle can be diluted to a ratio of 1:200, thus produces 50 litres of highly effective cleaning liquid. Removes blinding, oily films from the windscreen, and is the best product for the quality-conscious, economical driver. Special action: Increases the life of windscreen wipers. Can be mixed with any commercial antifreeze. Is also suitable for plastic headlight lenses and fan nozzles.



13.

14. HYDRAULIC OIL

Denso ND8 - for air conditioning compressor

X308 3.2 and 4.0 from VIN...812317 to F59525
250 ml can Part no. 277493



14.



15. K&N AIR FILTER CLEANER

The only cleaner formulated to clean K&N filtercharger elements. The use of other cleaning liquids can result in damaging the cotton material of the air filter and therefore the guarantee expires. K&N air filter cleaners are bio-degradeable and do not harm alloy, chrome, rubber, plastic and lacquer. K&N filters can be washed out up to 25 times before they need to be replaced.
330 ml. Part no. 4820
1 litre. Part no. 319259



15.

16. K&N AIR FILTER OIL

enough for 2 filters
20 ml bag Part no. 214887



16.

17. K&N AIR FILTER OIL

237 ml bottle Part no. 12353



17.

18. K&N AIR FILTER OIL

400 ml aerosol Part no. 311572



18.

K&N Air filter
see chapter 21.1

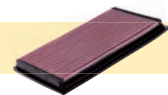

19. SCREEN WASH

with anti-freeze up to -70° C

With citrus fragrance. Keeps the windscreen clean and ice-free and saves on windscreen wash use.
1 litre bottle Part no. 394782
5 litres canister. Part no. 394781



Large cross-brand Oldtimer-special catalogue

- Accessories
- Workshop tools
- Oil and grease
- Books
- Car Care
- Consumables
- Equipment
- Classic seat belts

560
pages

Part no. 15119 (English)
Part no. 492147 (German)
Part no. 491321 (French)



Online Shop!
www.Limora.com



Note the use of brand names:

The inclusion of trade names in the index is purely for ease of looking up. The article described may not have been made by the owner of the trademark. All rights to brand names or trademarks belong to their rightful owners.

A

Accelerator cable 5.1
 Actuator 14.5
 Adaptor 21.2, 21.3
 Additive 7.1, 21.6
 Adjusting bolt 8.1
 Advance board 15.1
 Aerial 18.2
 Aerial mast 18.2
 Air conditioning compressor 14.4
 Air filter 6.1
 Air intake grille 17.1, 21.1
 Air-flow meter 6.1
 Alternator 14.1
 Anti roll bar link 8.1, 11.1
 Anti-freeze coolant 4.1, 4.2, 21.6
 Automatic gearbox oil 10.1, 21.6

B

Badge 13.1, 17.1
 Ball bearing 11.2
 Ball joint 8.1
 Ball joint separator 21.2
 Ballpoint pen 21.4
 Baseball cap 21.4
 Battery 21.3
 Battery charger 21.1
 Battery shelf panel 15.3
 Battery-Booster 21.1
 Blanking plug 1.1
 Bleed screw 12.1, 12.2
 Body contour gauge 15.1
 Bolt 8.1, 11.1, 11.2, 12.1, 12.3
 Bonnet 15.1
 Boot floor 15.3
 Boot lid 15.1
 Boot liner 20.1
 Boot mats 20.1
 Bottle opener 21.4
 Bracket 15.2
 Brake caliper 12.1, 12.2
 Brake discs 12.1, 12.2
 Brake fluid 12.3, 21.6
 Brake hose 12.1, 12.2
 Brake light switch 12.3
 Brake master cylinder 12.3
 Brake pads 12.1, 12.2
 Brake shoes 12.3
 Bulb 14.5, 14.7
 Bump stop rubber 11.1
 Bumper 16.1
 Bumper armature 16.1
 Bumper bracket 15.2, 16.1
 Bush 8.1, 11.1
 Bush kit 12.1, 12.2

C

C Tek Battery charger 21.1
 Cap 13.1
 Car cover 21.4
 Castrol Automatic gearbox oil 10.1, 21.6
 Castrol Brake fluid 12.3, 21.6
 Castrol Engine oil 1.1
 Castrol Full synthetic oil 1.1, 21.6
 Castrol Gear oil 11.2, 21.6

Centre silencer 9.1
 Chemico Valve grinding paste 21.3
 Circlip 8.1, 11.2
 Clamp 4.1
 Coffee mug 21.4
 Coil springs 8.1, 11.1
 Colour sample 21.4
 Combination spanner set 21.3
 Concorso wax 21.4
 Condenser 14.4
 Cone 20.1
 Connector 12.3, 21.1
 Connolly Leather care kit 20.1
 Control valve 5.1
 Conversion gasket set 1.1
 Conversion kit 1.1, 14.1
 Copper paste 12.1, 12.2
 Copper washer 2.1
 Corkscrew 21.4
 Cover 14.5, 19.2
 Cross tube 15.2
 CW 1:100 ® Screen treatment 19.1, 21.6
 Cylinder head bolt 1.2
 Cylinder head gasket 1.2
 Cylinder head gasket set 1.2

D

Das grosse Buch der Fahrzeugpflege 21.5
 Dolly 21.1
 Door 15.1
 Door check strap 18.2
 Door skin 15.1
 Drain plug 2.1
 Drain plug 2.1
 Drive belt 1.1, 14.1
 Dust cap 12.1, 12.2
 Dust cover 12.1, 12.2
 Dust seal 8.1
 Duster 21.4

E

EBC Brake pads 21.1
 Electric fan 4.1
 Element 14.7
 Elring Gasket paper 2.1
 Elring Sealing compound 1.1, 2.1
 End panel 15.2, 15.3
 Engine mounting 1.1
 Engine oil 1.1
 Essential Buyer's Guide 21.5
 Evaporator 14.4
 Exhaust bracket 9.1
 Exhaust clamp 9.1
 Exhaust mounting 9.1
 Exhaust mounting rubber 9.1

F

Filler cap 4.1, 12.3, 14.6
 Filler neck 14.6
 Filter 7.1
 FilterMAG Filtermag 21.1
 Fitting kit 12.1, 12.2, 16.1
 Fixing bracket 9.1
 Flange 11.2
 Flexible coupling 11.2
 Fluid level sensor 4.1
 Fog lamp 14.5
 Footwell carpets 20.1
 Front silencer 9.1
 Fuel filler cap 7.1
 Fuel filter 7.1
 Fuel injector 6.1
 Fuel pressure regulator 6.1

Fuel pump 7.1
 Fuel sender unit 7.1
 Fulcrum pin 11.1
 Full synthetic oil 1.1, 21.6
 Fuses 14.7

G

Gas strut 18.2
 Gasket 1.2, 4.1, 9.1
 Gasket remover 2.1
 Gear knob 20.1
 Gear oil 11.2, 21.6
 Gear wrench set 21.3
 Gearbox gasket set 2.1
 Gearbox mounting rubber 2.1
 Glass bonding adhesive 19.1
 Glazing rubber 19.1
 Grease 21.3
 Grease gun 21.3
 Grommet 18.2
 Guide 1.1

H

Halogen bulb 14.5
 Hammer 15.1
 Hand tap 21.3
 Handbrake cable 12.3
 Headlamp 14.5
 Headlamp cover 17.1
 Headlamp lens 14.5
 Heater hose 14.3
 Heater matrix 14.3
 Heater valve 14.3
 Holder 20.1
 Hose clip 4.1, 4.2, 10.1, 14.3
 Housing 14.7
 Hub cap 13.1
 Hub carrier 8.1
 Hydraulic oil 14.4, 21.6
 Hydraulic pipes 10.1
 Hydraulic reservoir 10.1

I

Idler pulley 1.1
 Ignition coil 14.2
 Ignition coil 14.2
 Ignition module 14.2
 Impact wrench 21.3
 Inner sill 15.2
 Inner wing 15.2
 Interior mirror 19.2
 Isolator buffer 8.1, 11.1

J

Jacking point 15.3
 Jaguar 21.5
 Jaguar Air conditioning compressor 14.4
 Jaguar Anti-freeze coolant 4.1, 4.2, 21.6
 Jaguar Ballpoint pen 21.4
 Jaguar Brake caliper 12.1, 12.2
 Jaguar Brake discs 12.2
 Jaguar Brake pads 12.1, 12.2
 Jaguar Fuel filter 7.1
 Jaguar Fuel pump 7.1
 Jaguar Gear knob 20.1
 Jaguar Ignition coil 14.2
 Jaguar Key fob 21.4
 Jaguar Mounting 8.1
 Jaguar Oil filter 1.1
 Jaguar Teddy Bear 21.4
 Jaguar Umbrella 21.4
 Jet 14.5, 14.6

K

K&N Air filter 21.1
 Key 18.2
 Key fob 21.4
 Key fob 21.4
 Key ring 21.4
 Knock sensor 5.1
 Koni Shock absorber 21.1

L

Lambda oxygen sensor 5.1, 9.1
 Lambda sensor chaser 5.1, 21.3
 Lambda sensor tester 5.1, 21.3
 Lamp 14.5
 Leaping cat 18.2, 21.1
 Leather care kit 20.1
 Letter opener 21.4
 Limora Valve grinder 21.3
 Location tube 11.1
 Lock plate 8.1, 11.2
 Locking nut 11.1
 Locking ring 7.1
 Luster Lace Polishing strips 21.4

M

Magazine 14.7, 20.1
 Magnet holder 21.3
 Main chassis rail 15.2, 15.3
 Manifold gasket 1.2, 6.1, 9.1
 Master Collection 21.4
 Mirage wax 21.4
 Mirror glass 19.2
 Moulding 16.1, 17.1, 18.2, 19.1
 Mounting 8.1
 Mudflaps 21.1
 Multimeter 21.3

N

Nameplate 18.1
 Net pocket 21.4
 NGK Spark plug 1.1, 14.2
 Non-return valve 14.6
 Number plate lamp 14.5
 Nut 11.1, 14.6, 18.2
 Nut splitter 21.3
 Nyloc nut 8.1, 11.1

O

,O' ring 2.1, 4.1, 7.1, 11.2, 14.4
 ,O' ring set 6.1
 Oil binding mat 21.4
 Oil drain pan 21.1
 Oil drain valve 21.1
 Oil filler cap 1.2
 Oil filter 1.1
 Oil filter wrench 21.3
 Oil pressure switch 5.1
 Oil seal 1.1, 2.1, 11.2
 Oil strainer 2.1
 Oil sump gasket 1.1, 2.1
 Onyx wax 21.4
 Outer sill 15.2

P

Packing 11.1
 Packing piece 8.1
 Pad 1.1
 Panel beater sand bag 15.1
 Paperweight 21.4
 Parking sign 21.4
 Pedal rubber 12.3
 Pin 12.1, 12.2

Piston 12.1, 12.2
 Pivot bolt 18.2
 Plain washer 8.1
 Pliers 14.3, 21.2
 Pocket wrench 21.3
 Pop rivet 16.1, 18.2
 Power steering unit 10.1
 Pressure switch 14.4
 Prymos® Fire extinguisher spray 21.4
 Puller 12.3, 21.2

R

Radiator 4.1
 Radiator grille panel 17.1, 21.1
 Radiator grille surround 17.1
 Radiator hose 4.1, 4.2
 Rear silencer 9.1
 Rear valance 15.3
 Rebuilt kit 12.3
 Receiver drier 14.4
 Reflector 14.5
 Reinforcement 15.2
 Relay 14.2, 14.7
 Remote key fob 18.2, 21.1
 Remover 21.2
 Repair panel 15.2, 15.3
 Retaining clip 6.1, 7.1, 12.3, 16.1,
 17.1, 18.2, 19.1, 19.2
 Return spring 12.3
 Rubber buffer 19.1
 Rubber bush 4.1, 4.2, 8.1, 10.1, 11.1, 14.4
 Rubber mats 20.1
 Rubber pad 8.1
 Rubber seal 6.1
 Rubber sealing ring 1.2
 Rubber strip 14.6

S

Screw with washer 9.1
 Screwdriver 21.3
 Seal 6.1, 18.2
 Seal kit brake caliper 12.1, 12.2
 Sealing compound 15.1
 Sealing ring 6.1, 7.1
 Sealing rubber 7.1, 14.6, 18.2
 Seat cover 21.4
 Sensor 5.1, 12.3
 Shim 11.1
 Shock absorber 8.1, 11.1, 21.1
 Side panel 15.1
 Slam panel 15.2
 Socket set 21.3
 Sockets 21.3
 Spacing washer 8.1, 11.1
 Special grease 8.1, 11.1
 Special socket 5.1
 Special spanner 13.1
 Special tool 21.2
 Special wrench 21.2
 Spire nut 16.1
 Spoke brush 13.1
 Spring and damper mounting 8.1, 11.1
 Spring clip 12.1, 12.2
 Spring collar 11.1
 Spring seat 8.1
 Stalk 14.7
 Starter motor 14.1
 Steering column 10.1
 Steering pump 10.1
 Steering rack gaiters 10.1
 Stool 21.4
 Strut 11.1
 Stud 9.1
 Suction pad 15.1

Supercharger radiator 4.2
 Support panel 15.2
 Switch 12.3
 Swizöl Concorso wax 21.4
 Swizöl Master Collection 21.4
 Swizöl Mirage wax 21.4
 Swizöl Onyx wax 21.4

T

Tachometer 21.3
 Tail pipe finisher 9.1
 Tapered roller bearing 11.1, 11.2
 Taptite nut 8.1, 9.1
 Teddy Bear 21.4
 Temperature sensor 5.1
 Tension pulley 1.1
 Thermal transmitter 5.1
 Thermometer 21.3
 Thermostat 1.2, 4.1
 Thermostat housing 1.2, 4.1, 21.1
 Threaded rivet 16.1, 17.1, 18.2
 Threshold plate 20.1
 Throttle body 6.1
 Timing chain 1.1, 1.2
 Timing chain kit 1.1, 1.2
 Timing chain tensioner 1.1, 1.2
 Timing rotor 8.1, 11.1, 12.3
 17.1, 18.2, 19.1, 19.2
 Tool kit 19.1
 Torque wrench 21.3
 Towing eye 15.2
 Track rod end 10.1
 Tube collar 11.1
 Tube nut 18.2
 Tuga Chemie Wheel cleaner 13.1
 Type guide 21.5
 Tyre valve caps 13.1, 21.4

U

Umbrella 21.4
 USB memory stick 21.4

V

Valve grinder 21.3
 Valve grinding paste 21.3

W

Wagner Additive 7.1, 21.6
 Washer bottle 14.6
 Washer pump 14.6
 Water pump 4.1, 4.2, 14.3, 14.4
 Wedge 21.2
 Wheel arch 15.3
 Wheel arch set 21.1
 Wheel bearing 8.1
 Wheel bearing kit 11.1
 Wheel lock nuts 13.1
 Wheel nut 13.1
 Wheel stud 8.1, 11.1, 13.1
 Windscreen 19.1
 Wing 15.1
 Wing cover 15.1, 21.4
 Wiper blade 14.6
 Wiper motor 14.6
 Wire wheel 13.1
 Wishbone 8.1



