

„Wherever you go - it's more fun when you drive a Triumph“

The so-called TS20, a prototype Roadster was presented to the audience at the London Motor Show in October 1952. Following this concept car, the team around of chief engineer Ken Richardson developed the TR2 during the winter of 1952/53, but quite different to the initial design. This car had a new chassis frame, more powerful engine and lengthened tail style.

The official launch of the TR2 took place on the 9th of March 1953 at the Geneva Motor Show. The engine was a twin carburettor Standard Vanguard engine that was capable of producing 90 BHP and achieving a 105 MPH top speed. The first two hand-assembled cars were completed in July 1953 and finally production of the TR2 began in August 1953. Every single car included extra features without extra cost: more joy in driving.

In October 1955 the TR2 got a minor facelift and was named TR3. The new model was attached with a new „egg-box“ radiator grille, side screens with sliding windows, chromed bonnet and boot hinges, polished stainless steel wing beadings, a new front badge now read TR3, a new passenger seat with tilt back and an optional occasional rear seat. Mechanical changes were few, the most obvious being the slightly modified cylinder head, the change to 1.3/4“ SU-H6 carburettors. These changes provided 95 BHP, an increase of 5%. A reel sensation took place in August 1956. From commission no. TS13046 onwards The TR3 was the first British production car equipped with front disc brakes. On the continent only the popular Citroen DS19 was fitted with disc brakes.

The best selling side screen TR, which took over from the TR3 in September 1957 was the TR3A. The obvious revisions for these models was a new full-width radiator grill with integrated indicator lamps, an altered front bumper, a new front shroud with new badge and lockable external door and boot handles. Several significant visual modifications in October 1959 after commission no. TS60001.

The TR3B, which was manufactured between March and December 1962, was a special limited production run for the North American export market. It had the body of the TR3A, but the all-synchro gearbox from the TR4.

The Triumph TR4 was introduced in July 1961 and was the first Leyland TR. The body had been given a modern and updated appearance by car designer Giovanni Michelotti. The engine featured a larger capacity with 2138cc. (86mm bore); a new and more effective heater was fitted. A rack and pinion steering replaced the worm type steering box used on its predecessors and an all-synchro gearbox was introduced. Suspension and chassis based on the TR3A. The most desired optional extra was the removable hard top, the so-called surrey top.

A straightforward evolution of the TR4, the TR4A was introduced in January 1965. The major changes for this model were the independent rear suspension with a new differential which was attached to the chassis and the drive reached the wheels by way of drive shafts with universal joints at each end. These revisions required a redesigned frame and a number of small changes and refinements on the front suspension. Apart from the suspension the electrical system was converted to negative earth. Also handbrake, radiator, exhaust system and clutch underwent technical modifications. Parallel to the IRS models approximately 7.000 TR4A were prepared with solid rear axles as LHD models for the North American market. In July 1967 finally the TR4-cylinder production ceased. A total of 152.378 TR2 to TR4A left the factory in Canley.

We are proud to present our new catalogue that will help you to keep your classic Triumph on the road. We have more than 600 pages of Triumph parts, this covers almost every part produced by Triumph. We, together with our English sister company SC-Parts Group Ltd will undertake every effort to find those parts that are deemed to be no longer available.

At this point of the copy deadline our parts database covers exactly 485.048 different items, many of the items are in stock at our central warehouse which has been expanded to keep up with the demand of new ranges. More than 100.000 lines are kept on the shelf for fast and efficient dispatch on over 55.000 sq. foot of storage space:

I.e. order today, receive tomorrow!

- **Orders accepted by:** Fax, e-mail, internet, post or telephone
- **Despatch:** Next day delivery for every order given until 16.00
Next day courier possible
- **Warehouse:** More than 100.000 items on stock
- **No minimum order**
- **No costs for packaging**
(except engines, gearboxes, glass, long exhausts)
- **Carriage charge only**
- **Payment:** All major credit cards or cash by delivery
- We invite you to **visit our shops**
- **Opening times**

Mo - Fr: 8.00 - 18.30
Sa: 8.30 - 13.00

German version
available.
Part no. 287210

LIMORA main office

Industriepark Nord
D - 53567 Buchholz

Jaguar: +49 (0) 26 83 - 70 61

Triumph: 70 62

Mini: 70 63

MG: 70 64

Austin Healey: 70 65

Fax: 70 59

e-mail: Limora@Limora.com

Limora Aachen

Feldchen 15
D - 52070 Aachen

Tel: +49 (0) 241 - 55 939 0

Fax: +49 (0) 241 - 55 939 20

e-mail: Aachen@Limora.com

Nous parlons français

Wij spreken nederlands

Limora Berlin

im Meilenwerk
Wiebestraße 36-37
D - 10553 Berlin

Tel: +49 (0) 30 - 25 93 92 30

Fax: +49 (0) 30 - 25 93 92 33

e-mail: Berlin@Limora.com

Limora Düsseldorf

Im Meilenwerk
Harffstraße 110a
D - 40591 Düsseldorf

Tel: +49 (0) 211 - 98 471 01

Fax: +49 (0) 211 - 98 471 08

e-mail: Duesseldorf@Limora.com

Limora Paris

Tel: +33 (0) 139 - 57 05 99
Fax: +33 (0) 139 - 57 06 99
e-mail: Paris@Limora.com

Limora Polska

e-mail: Warszawa@Limora.com

Informacje również w języku polskim

Iwona: +49 (0) 26 83 - 70 61
Krzysztof: +49 (0) 26 83 - 70 62
Anna: +49 (0) 26 83 - 70 63
Mirek: +49 (0) 26 83 - 70 64

Online shop: www.Limora.com



1.1

Engine

Exchange engines

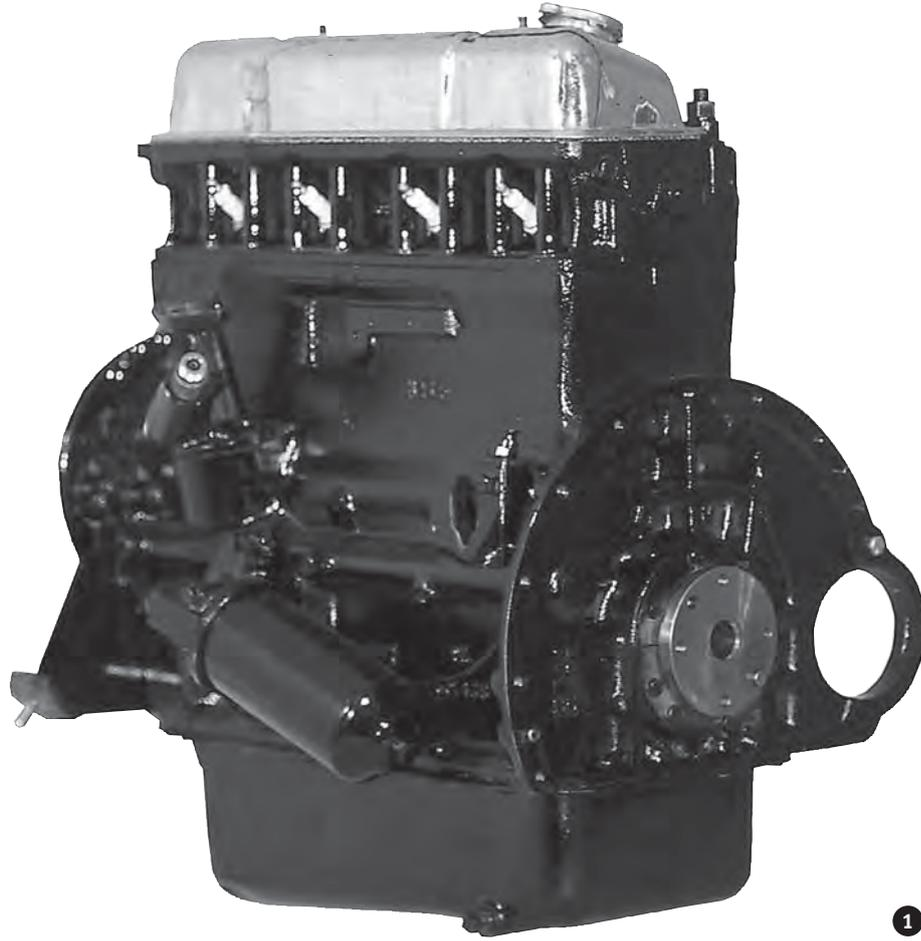

Engine paint
black

1 litre

Part no. 9916

400 ml aerosol

Part no. 15762

No	Part No	Description	Qty	Notes
1	217864	Engine with 83 mm bore size and ,low port' cylinder head	1	} TR2, TR3 to engine no. TS13051E. Identify by 13.3/8" space between engine mounting holes on front plate
1	320246	Engine with 86 mm bore size and ,low port' cylinder head	1	
1	450727	Engine with 83 mm bore size and ,high port' cylinder head	1	} TR3 from engine no. TS13052E, TR3A, TR3B. Identify by 13.3/8" space between engine mounting holes on front plate
1	309546	Engine with 86 mm bore size and ,high port' cylinder head	1	
1	300260	Engine with 87 mm bore size and ,high port' cylinder head	1	
1	214239	Engine with 86 mm bore size and ,high port' cylinder head	1	} TR4, TR4A. Identify by 14.3/4" space between engine mounting holes on front plate
1	478693	Engine with 87 mm bore size and ,high port' cylinder head	1	

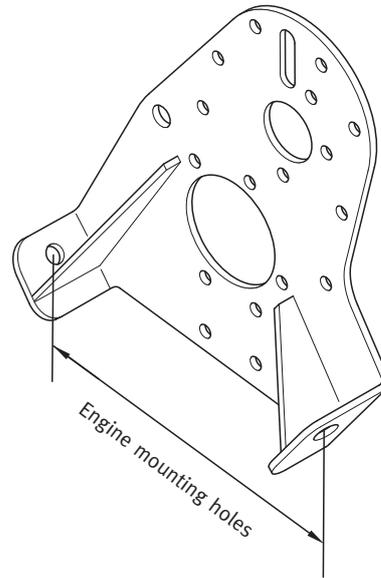

Tilt and lift engine hoist

easy adjustment of an engine's lift angle through a full 90° of movement. 1/2" square drive. Capacity 2000 pound.
Part no. 303036

Note: Engines - exchange

All our engines are developed for lead free applications. All engines are equipped with new pistons, piston pins, piston rings, main and big end bearings, small-end bushes, timing chain, gaskets, front oil seal and core plugs. Every cylinder head is inspected for cracks. Valve guides are measured for wear and either resized or renewed to conform to original tolerances. Valve seats are machined so as to retain the correct seat angles, widths, valve heights and valve seating concentric with the centre line of the valve guide bore. Valves are replaced. All valve springs are tested for squareness, free height and compressed load length. Cylinder heads are checked for distortion and thickness. When machining the cylinder head face, particular attention is paid to maintaining the correct surface finish specified by the gasket manufacturer. Camshafts are either replaced with a new unit or reprofiled to their original valve timing and lift specifications. Crankshafts are grinded and polished to produce the exact dimensions and surface finish required. Each cylinder block is rebored or resleeved and honed to give the precise surface finish and cross-hatch required. All main housings are measured for size, ovality, taper and weight-graded into engine sets. Every con rod is checked for alignment and weight-graded into engine sets. Oil pump: The clearance between rotor and body is measured. The oil pressure valve is dismantled and cleaned. All non-conforming parts are replaced. All our engines are hot run under their own power in purpose-built test cells. Every engine is subjected to a series of checks and the results are recorded against each specific engine serial number. On all our engines we grant with professional installation 6-month guarantee in accordance with our general terms of trade.

1.2

Engine

Oil sump

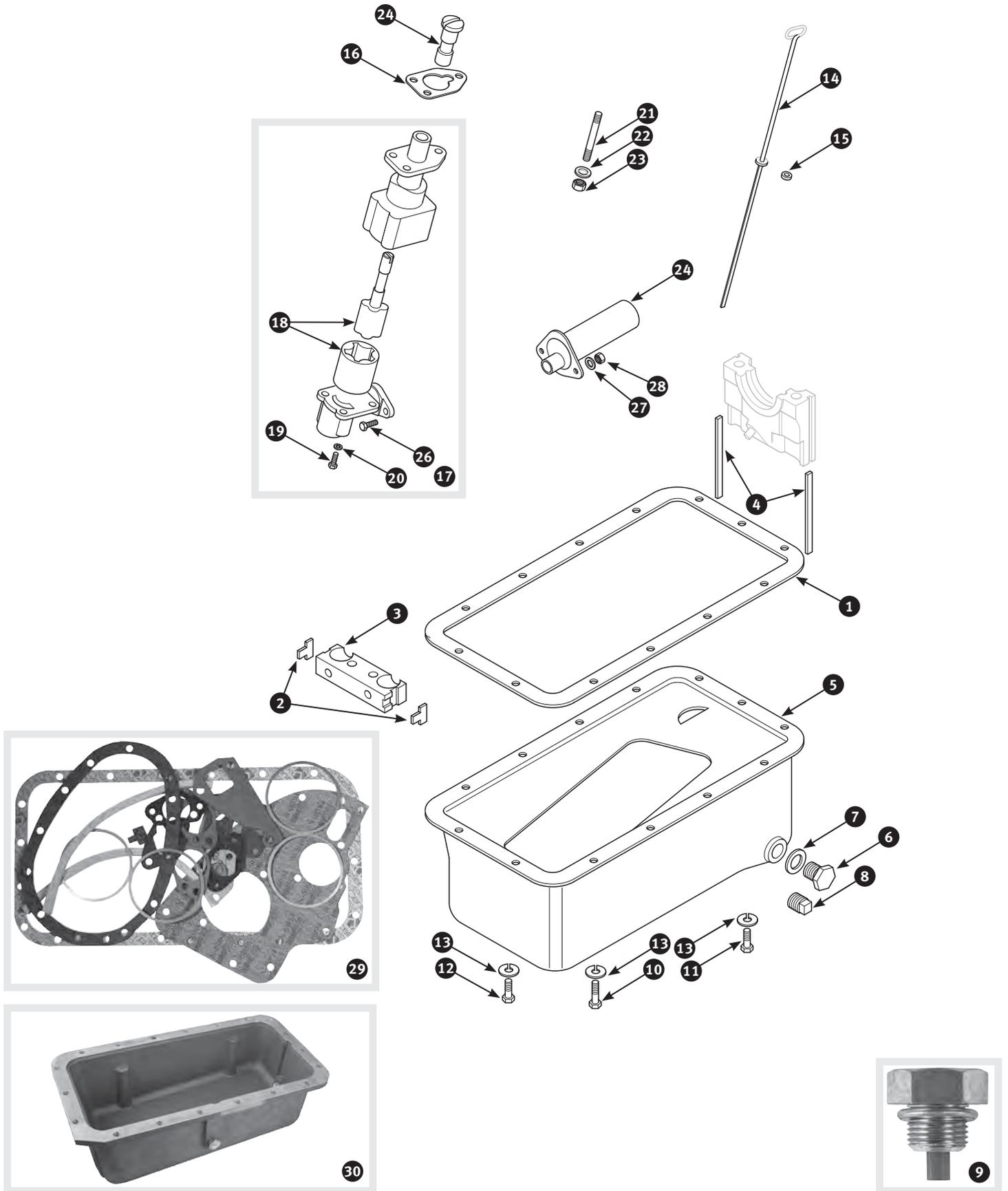

No	Part No	Description	Qty	Notes	
1	335	Gasket oil sump	1		
2	3425	Cork gland on front sealing block	2		
3	2328	Sealing block oil sump front.	3		
4	3402	Felt strip rear main bearing cap	2		
5	302283	Oil sump steel, identify by shouldered plug	1	} TR2, TR3 to engine no.TS18901E	
5	473427	Oil sump steel, identify by tapered plug	1		} TR3 from engine no. TS18902E, TR3A to TR4A
6	8114	Drain plug oil drain - shouldered.	1	} TR2, TR3 to engine no. TS18901E	
7	3053	Fibre washer	1		
8	14245	Blanking plug oil drain, tapered - square headed	1	} TR3 from engine no. TS18902E, TR3A to TR4A - alternatives	
8	8862	Oil filler plug oil drain, tapered - allen drive.	1		
9	9521	Drain plug oil drain, tapered - magnetic type with socket head	1		
10	7877	Screw oil sump to cylinder block.	16	} If breather pipe is fitted	
11	10717	Bolt oil sump, breather pipe and slave cylinder stay attachment	2		
10	7877	Screw oil sump to cylinder block.	17	} If breather pipe is not fitted	
11	10717	Bolt oil sump, breather pipe and slave cylinder stay attachment	1		
12	7887	Screw oil sump to front sealing block	1		
13	212194	Spring washer	19		
14	19453	Dipstick	1		
15	3392	Felt seal dipstick	1		
16	5031	Gasket oil pump	1		
17	2884	Oil pump	1		
18	369	Rotor and spindle	1		
19	299716	Screw oil pump housing.	4		
20	212192	Spring washer	4		
21	200361	Stud oil pump to cylinder block	3		
22	212194	Spring washer	3		
23	2303	Nut	3		
24	15346	Bush oil pump drive shaft	1		
25	14659	Oil strainer oil pump	1		
26	3295	Screw oil strainer to pump	2		
27	212192	Spring washer	2		
28	2828	Nut	2		
29	319268	Conversion gasket set	1		
30	10832	Oil sump alloy.	1		

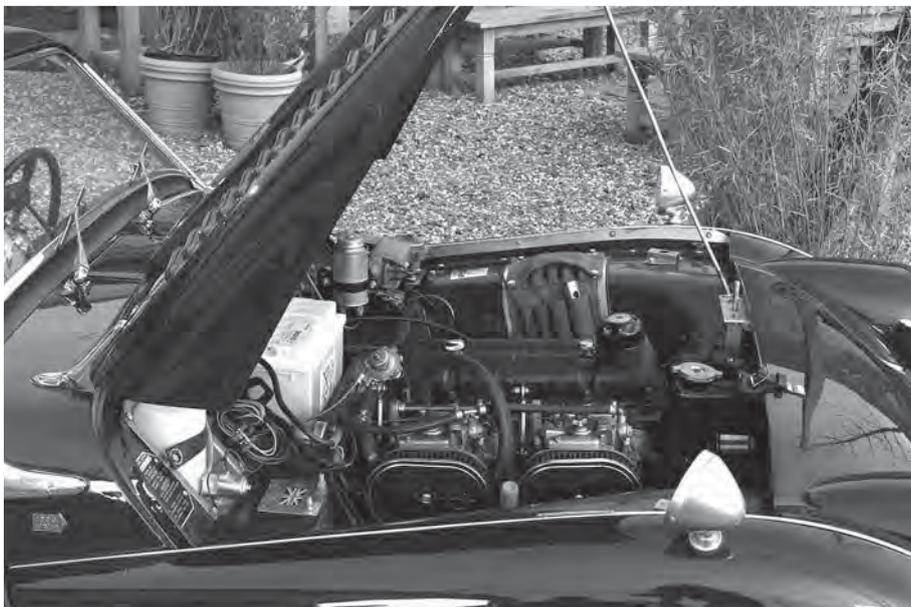

1.3

Engine

Crankshaft

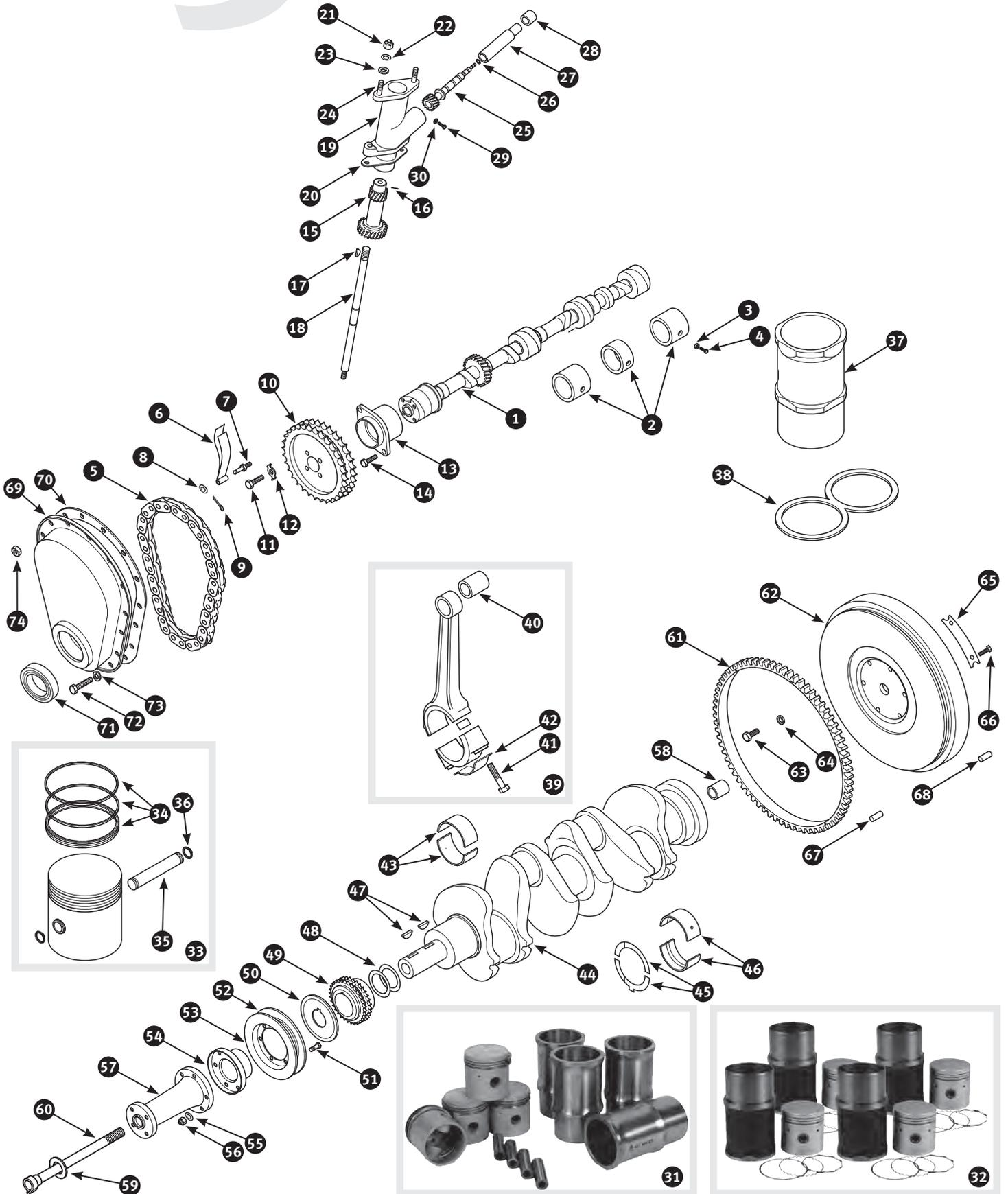

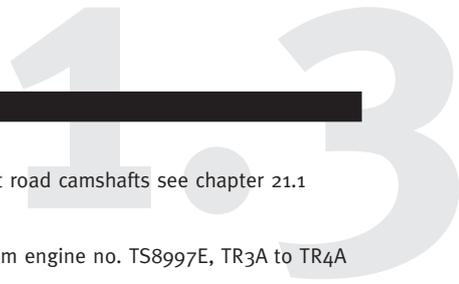

No	Part No	Description	Qty	Notes
1	14657	Camshaft new item	1	} For fast road camshafts see chapter 21.1
1	216317	Camshaft exchange	1	
2	21150	Camshaft bearing set	1	} TR3 from engine no. TS8997E, TR3A to TR4A
3	212193	Plain washer camshaft bearing	3	
4	355022	Screw camshaft bearing	3	
5	3878	Timing chain duplex.	1	
6	3395	Timing chain tensioner	1	} Quantity as required
7	15347	Anchor bolt timing chain tensioner	1	
8	20045	Plain washer	0	
9	3805	Split pin	1	
10	3416	Sprocket camshaft	1	
11	3343	Bolt camshaft sprocket retaining	2	
12	3845	Lock tab camshaft sprocket	1	} Distributor and tachometer drive
13	14658	Camshaft bearing front, with housing assembly	1	
14	3343	Bolt camshaft retaining	2	
15	289445	Drive gear distributor.	1	
16	2784	Pin distributor drive gear	1	
17	8128	Woodruff key	1	
18	289159	Drive shaft oil pump	1	
19	1646	Housing - new item made from cast iron	1	
19	337600	Housing - new item made from aluminium.	1	
19	215035	Housing - used item	1	
20	4756	Gasket	1	} Distributor retaining
21	2828	Nut	2	
22	212191	Plain washer	2	
23	212192	Spring washer	2	
24	19548	Stud	2	} With liners assembly
25	300019	Drive gear tachometer - new item	1	
25	215036	Drive gear tachometer - used item	1	
26	19748	Oil seal	1	
27	14895	Bronze bearing drive gear - new item	1	
27	215037	Bronze bearing drive gear - used item	1	
28	371113	Screwed sleeve on drive gear bearing - new item	1	
28	215038	Screwed sleeve on drive gear bearing - used item	1	
29	15339	Screw bearing locking	1	
30	212194	Spring washer	1	
31	20714	County Piston set with 83.0 mm bore size	1	} 4-ring piston, standard bore size: 3.267", compression ratio: 8.5:1
31	6481	County Piston set with 86.0 mm bore size	1	
31	215341	County Piston set with 87.0 mm bore size	1	
31	318993	County Piston set with 87.5 mm bore size	1	
32	20830	Mahle Piston set with 86.0 mm bore size.	1	} 3-ring piston, standard bore size: 3.386", compression ratio: 9.0:1
32	26225	Mahle Piston set with 87.0 mm bore size.	1	
33	9839	Piston set standard	1	
33	9840	Piston set +0.020".	1	
33	9841	Piston set +0.030".	1	} 3-ring piston, standard bore size: 3.386", compression ratio: 9.0:1
33	9835	Piston set standard	1	
33	9836	Piston set +0.020".	1	
33	9837	Piston set +0.030".	1	
33	9838	Piston set +0.040".	1	} 3-ring piston, standard bore size: 3.386", compression ratio: 9.0:1
33	302688	Piston set +0.060".	1	

1.3

Engine

Crankshaft

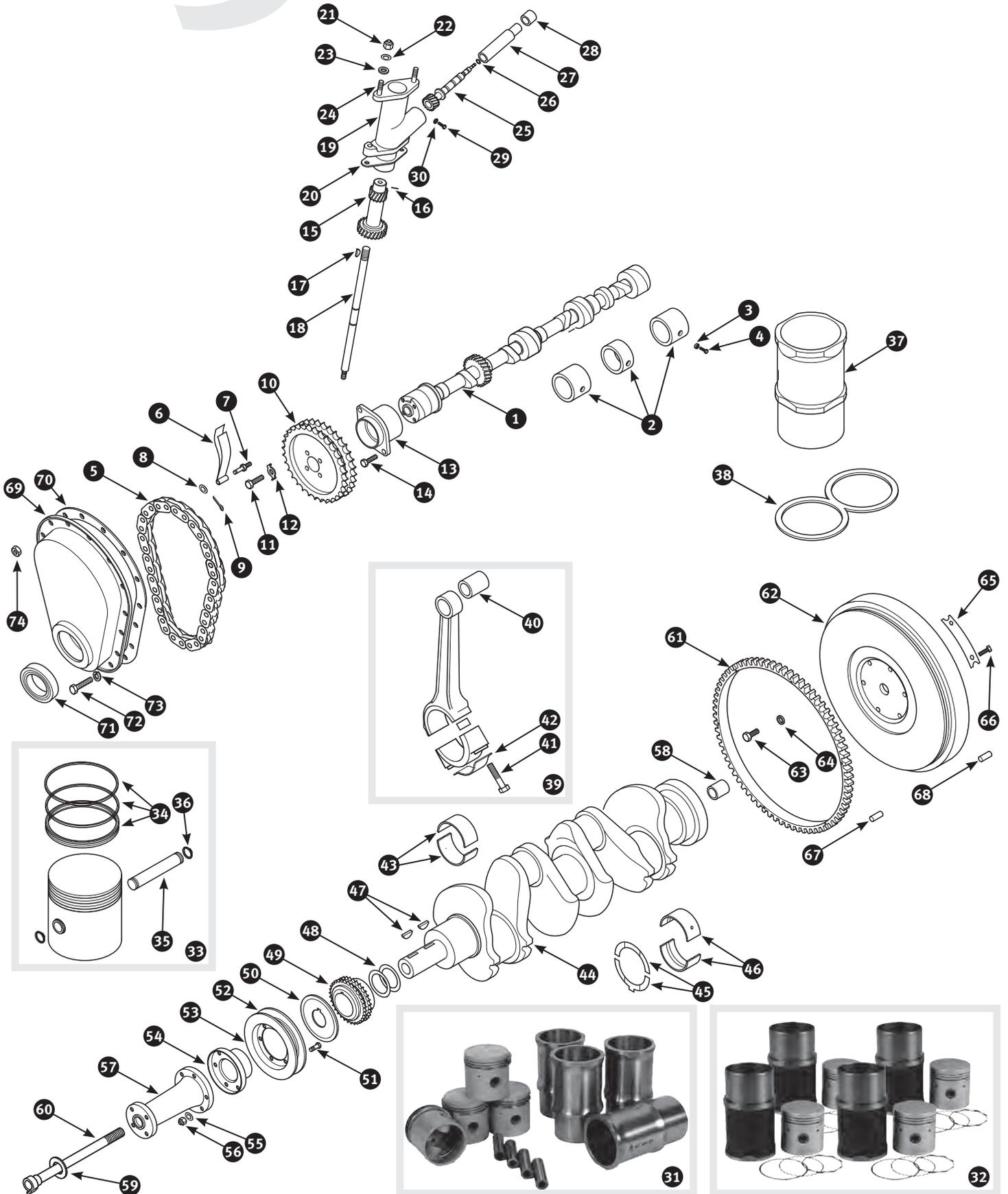



No	Part No	Description	Qty	Notes
34	17357	Piston ring set standard	1	} 3-ring piston, standard bore size: 3.267"
34	17358	Piston ring set +0.020"	1	
34	17359	Piston ring set +0.030"	1	
34	17360	Piston ring set +0.040"	1	
34	17361	Piston ring set +0.060"	1	
34	17362	Piston ring set standard	1	
34	17363	Piston ring set +0.020"	1	
34	17364	Piston ring set +0.030"	1	
34	17365	Piston ring set +0.040"	1	
34	17366	Piston ring set +0.060"	1	
34	17367	Piston ring set standard	1	} 3-ring piston, standard bore size: 3.386"
34	17368	Piston ring set +0.020"	1	
34	17369	Piston ring set +0.030"	1	
34	17370	Piston ring set +0.040"	1	
34	17371	Piston ring set standard	1	
34	17372	Piston ring set +0.020"	1	
34	17373	Piston ring set +0.030"	1	
35	293905	Gudgeon pin	4	
36	21376	Circlip gudgeon pin	8	
37	322463	Cylinder liner for 83.0 mm piston	4	
37	2380	Cylinder liner for 86.0 mm piston	4	
37	20468	Cylinder liner for 87.0 mm piston	4	
38	195	Gasket liners to block	2	
39	3255	Con rod new item	4	
39	18141	Con rod exchange	4	
40	2239	Con rod bush	4	
41	1236	Lock tab	4	} TR2 to TR3A, TR4 to engine no. CT34071E
42	2347	Con rod bolt	8	
42	2399	Con rod bolt self locking	8	} TR4 from engine no. CT34072E, TR4A
43	9845	Big end bearing set standard	1	
43	9823	Big end bearing set +0.010"	1	
43	9824	Big end bearing set +0.020"	1	
43	9825	Big end bearing set +0.030"	1	
43	9826	Big end bearing set +0.040"	1	
43	310064	Big end bearing set +0.050"	1	
43	11394	Big end bearing set +0.060"	1	
44	15876	Crankshaft exchange	1	
44	355492	Crankshaft exchange	1	} Ground ready for rear oil seal conversion
45	9815	Main bearing set standard	1	
45	9820	Main bearing set +0.010"	1	
45	9821	Main bearing set +0.020"	1	
45	9846	Main bearing set +0.030"	1	
45	9822	Main bearing set +0.040"	1	
45	11531	Main bearing set +0.050"	1	
45	13130	Main bearing set +0.060"	1	
46	10401	Thrust washer set standard	1	
46	15466	Thrust washer set +0.005"	1	
46	16450	Thrust washer set +0.008"	1	
47	8131	Woodruff key	2	
48	290788	Shim crankshaft sprocket +0.004"	0	} Quantity as required
48	21313	Shim crankshaft sprocket +0.006"	0	
49	3398	Sprocket crankshaft	1	
50	21377	Oil thrower	1	
51	3938	Bolt	6	
52	10701	Pulley rear half	1	} Flat
53	10679	Pulley front half	1	} Dished
54	21384	Flange	1	
55	212191	Plain washer	2	
56	212451	Nyloc nut	6	
57	16405	Extension fan	1	} TR2 to TR3A

1.3

Engine

Crankshaft

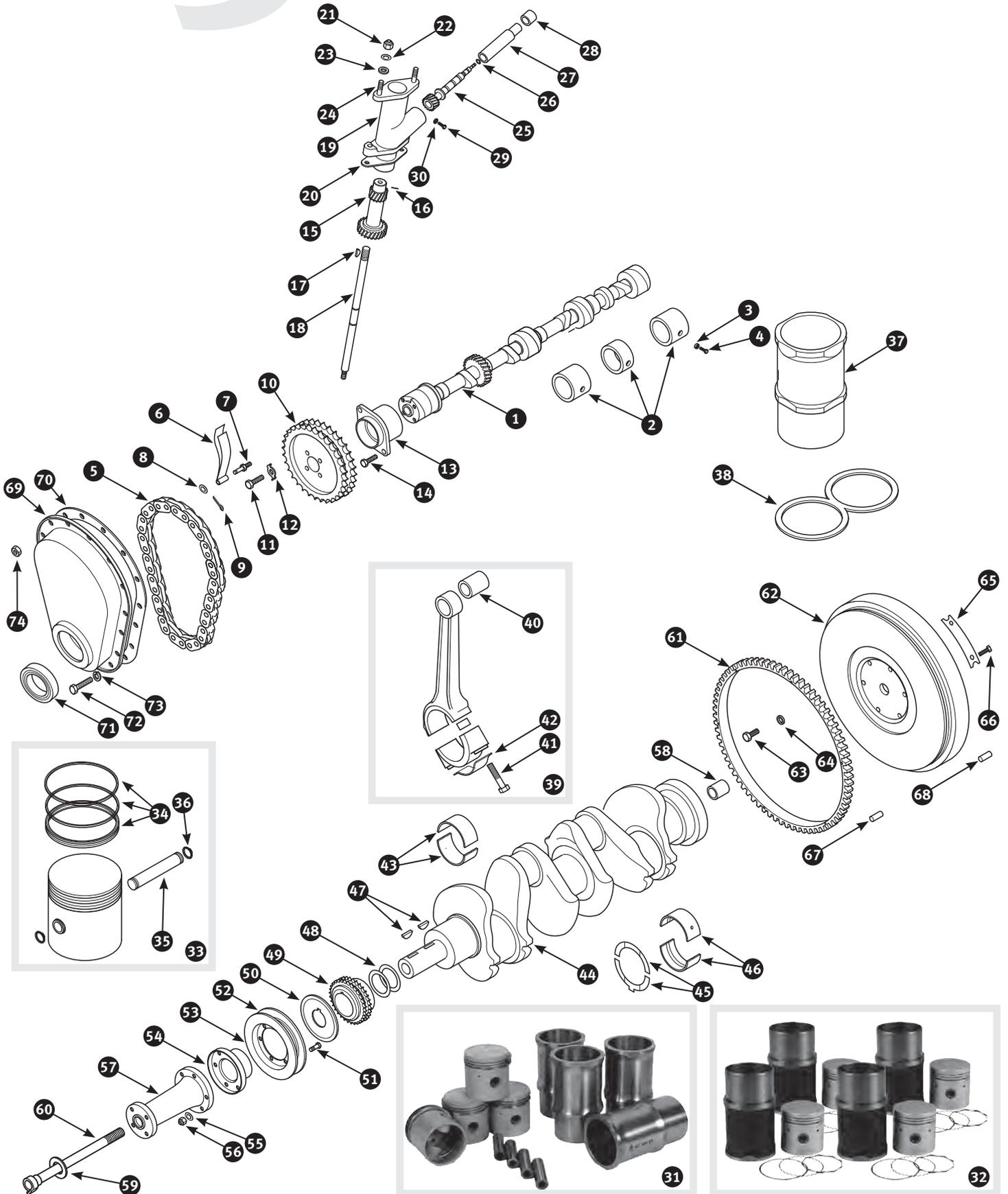

No	Part No	Description	Qty	Notes
57	16406	Extension fan	1	} TR4 and TR4A
58	3339	Spigot bush crankshaft	1	
59	11305	Shim	1	
60	16478	Centre bolt with starting handle slot	1	} TR2 to TR3A
60	5318	Centre bolt with starting handle slot	1	
61	10407	Ring gear shrink-on type	1	} TR2 and TR3, TR3A to engine no. TS50000E
62	319580	Flywheel exchange.	1	
61	201082	Ring gear bolt-on type	1	
62	327478	Flywheel exchange.	1	
63	5098	Bolt ring gear to flywheel.	6	} TR3A from engine no. TS50001E, TR4 and TR4A
64	10410	Lock tab ring gear to flywheel.	6	
65	3399	Lock tab flywheel	2	} TR2 to TR3A, TR4 to engine no. CT34071E
66	9755	Bolt ,stretch' type - flywheel to crankshaft.	4	
67	14917	Striker pin flywheel to crankshaft	1	
68	9653	Dowel flywheel to clutch cover	2	} TR2 to TR4
68	9653	Dowel flywheel to clutch cover	3	



Oil seal conversion kit
 crankshaft rear, TR2-4A
 Part no.26343

Oil drip mat
 sizes: 90 x 120 cm, oil consumption: 4 litre
 Part no.355878



1.4

Engine

Cylinder block

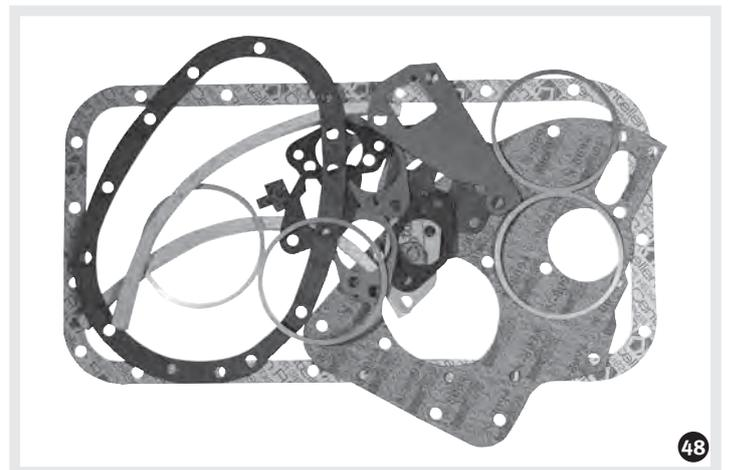
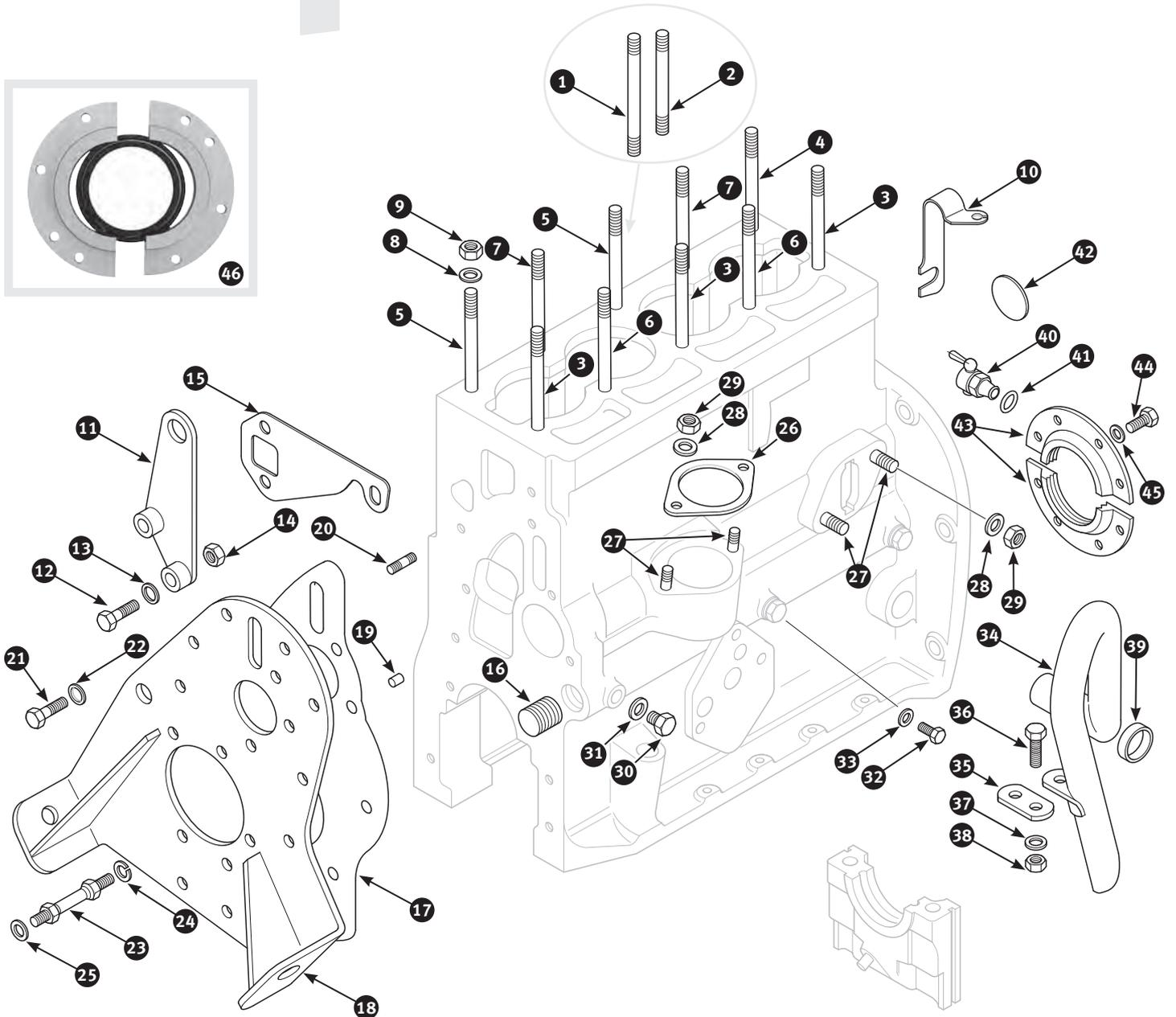
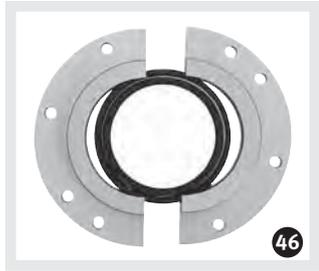

No	Part No	Description	Qty	Notes
1	2356	Stud cylinder head - length 9"	4	} TR2 to engine no. TS13051E - cars with , low port' cylinder head
2	2355	Stud cylinder head - length 5"	6	
3	2355	Stud cylinder head - length: 5"	3	
4	2371	Stud cylinder head - length: 5.3/8". All engines without lifting bracket	1	} TR2 from engine no. TS13053, TR3 to TR4A - cars with ,high port' cylinder head
4	3890	Stud cylinder head - length: 5.9/16". All engines with lifting bracket.	1	
5	2371	Stud cylinder head - length: 5.3/8"	2	
6	2356	Stud cylinder head - length 9"	2	
7	2370	Stud cylinder head - length: 9.1/2"	2	
8	1839	Washer cylinder head.	10	
9	9570	Cylinder head nut	10	} Lifting eye to engine plate
10	2379	Lifting bracket rear	1	
11	10366	Lifting eye front.	1	
12	3381	Bolt lifting eye to engine plate	2	
13	212194	Spring washer	2	} Lifting eye to engine plate
14	2303	Nut	2	
15	9700	Gasket water pump housing to block	1	} TR2 to TR3A
16	1087	Plug oil gallery ends - stick with 9 pieces	1	
17	2330	Gasket engine plate.	1	} TR4 and TR4A
18	21418	Engine plate front	1	
18	21419	Engine plate front	1	} TR4 and TR4A
19	4910	Pin engine plate	2	
20	200361	Stud engine plate	1	} TR4 and TR4A
21	7877	Screw engine plate	5	
22	212194	Spring washer engine plate	5	} TR4 and TR4A
23	11307	Stud timing cover support	1	
24	212194	Spring washer	1	} TR4 and TR4A
25	9418	Fibre washer	1	
26	4756	Gasket distributor and tachometer drive housing	1	} Distributor, tachometer drive housing and fuel pump attachment
27	200361	Stud	4	
28	212194	Spring washer	4	
29	2303	Nut	4	
30	21380	Screw plug oil gallery.	3	} TR2 to TR3A, TR4 to engine no.CT25393E
31	5465	Copper washer	3	
32	319459	Screw oil gallery	1	} TR2 to TR3A, TR4 to engine no.CT25393E
33	5543	Copper washer	1	
34	312726	Breather pipe new item	1	} TR2 to TR3A, TR4 to engine no.CT25393E
34	25920	Breather pipe used item.	1	
35	21393	Bracket breather pipe	1	} TR2 to TR3A, TR4 to engine no.CT25393E
36	7893	Screw breather pipe to bracket.	1	
37	212194	Spring washer breather pipe to bracket.	1	} TR4 from engine no. CT23594E, TR4A
38	2303	Nut breather pipe to bracket.	1	
39	19594	Blanking plug for engines with closed circuit breathing.	1	} TR4 from engine no. CT23594E, TR4A
40	3443	Water drain tap	1	
41	3807	Fibre washer water train tap.	1	} TR4 from engine no. CT23594E, TR4A
42	3335	Core plug camshaft - rear.	1	
43	3442	Oil sealing ring crankshaft rear - 2 pieces	1	} TR4 from engine no. CT23594E, TR4A
44	212153	Screw	8	
45	212192	Spring washer	8	} For further information see chapter 21.1
46	319268	Conversion gasket set	1	
47	3476	Hylomar universal jointing compound, 100g. tube.	1	
48	26343	Oil seal conversion kit crankshaft rear	1	} For further information see chapter 21.1

1.5

Engine

Cylinder head

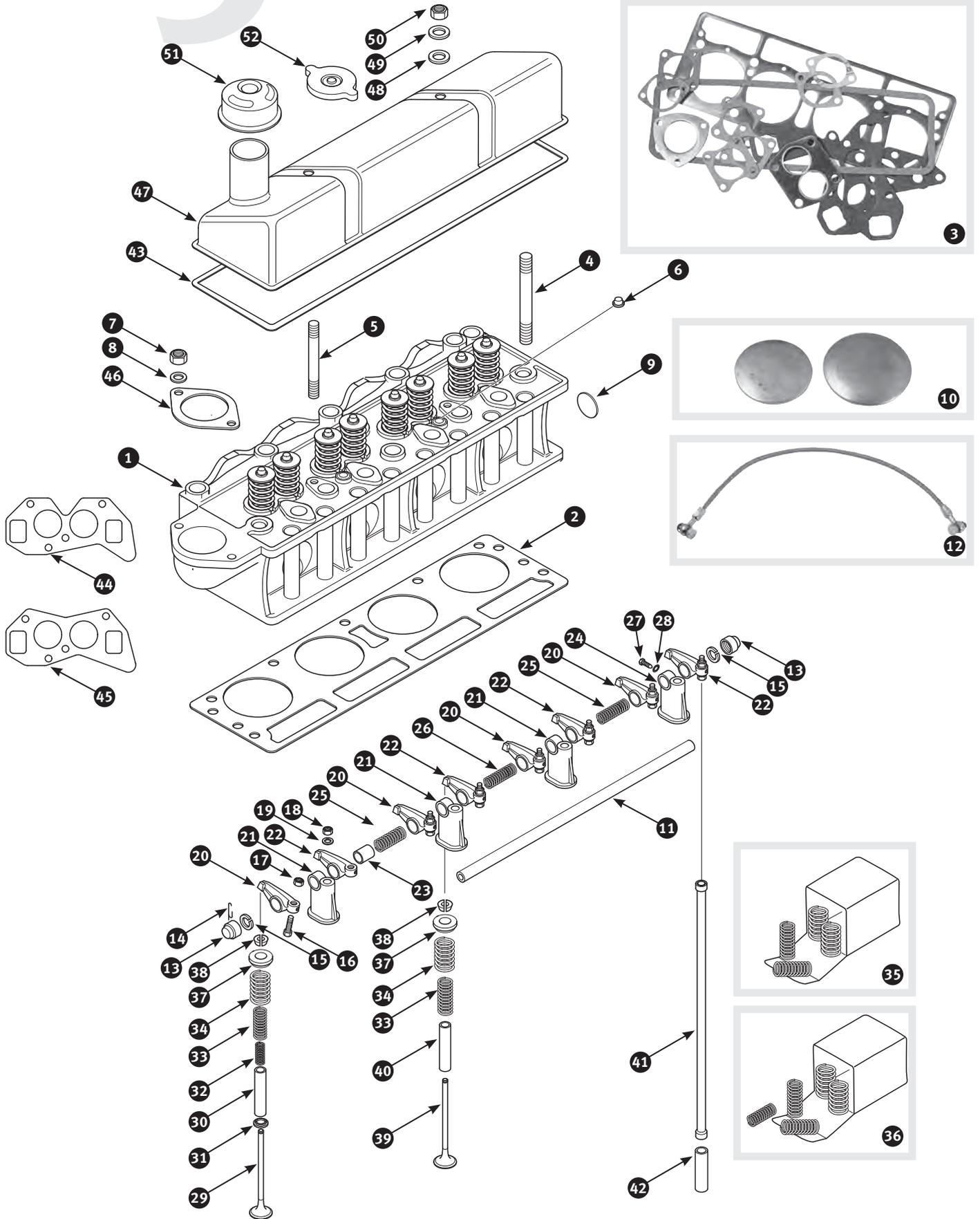

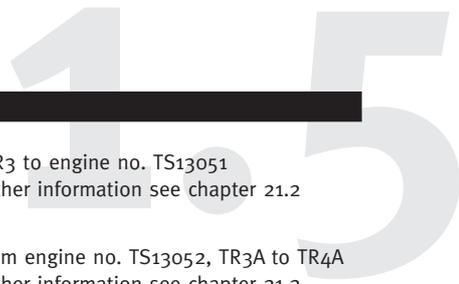

No	Part No	Description	Qty	Notes
1	18087	Cylinder head exchange. ,Low port' type complete with valves and valve springs	1	} TR2, TR3 to engine no. TS13051 For further information see chapter 21.2
1	210207	Cylinder head exchange. ,High port' type complete with valves and springs	1	
1	212628	Cylinder head new item made from cast iron. ,High port' type without valves, valve guides and valve seat inserts	1	} TR3 from engine no. TS13052, TR3A to TR4A For further information see chapter 21.2
1	328185	Cylinder head new item made from aluminium. ,High port' type complete with valves, valve guides and valve springs	1	
1	319160	Cylinder head new item made from aluminium. ,High port' type with valve guides and valve seats	1	} TR3 from engine no. TS13052, TR3A to TR4A For further information see chapter 21.2
2	201083	Payen Cylinder head gasket for 83 to 86 mm pistons	1	
2	319266	Cylinder head gasket for 83 to 86 mm pistons	1	} Alternatives
2	10579	Composite cylinder head gasket for 87 mm pistons	1	
3	13657	Cylinder head gasket set ,low port'	1	} TR2, TR3 to engine no. TS13051
3	972	Payen Cylinder head gasket set ,high port'	1	
3	318882	Cylinder head gasket set ,high port'	1	} TR3 from engine no. TS13052, TR3A to TR4A
4	9667	Stud rocker pedestal	4	
5	293829	Stud original rocker cover.	2	
5	12460	Stud alloy rocker cover	2	
6	10074	Core plug top face of cylinder head.	1	
7	9570	Cylinder head nut	10	
8	1839	Washer	10	
9	3308	Core plug cylinder head - 45 mm, dished type	1	} TR2 to early TR4A
10	315706	Core plug set cylinder block and head - dished type	1	
9	5852	Core plug cylinder head - 1.5/8", cup type	1	} Late TR4A
10	215081	Core plug set cylinder block and head - cup type	1	
11	241	Rocker shaft	1	} Alternatives
11	13050	Rocker shaft tuftride	1	
12	13573	Oil feed pipe for external rocker shaft lubrication	1	
13	3441	Plug cover	2	
14	2784	Pin	2	
15	5115	Double coil washer	2	
16	5089	Adjusting screw	8	
17	9173	Locking nut	8	
18	3073	Nut	4	
19	2051	Spring washer	4	
20	9744	Rocker no. 1, 3, 5, 7	4	
21	293262	Pedestal front and intermediate	3	
22	4760	Rocker no. 2, 3, 6, 8	4	
23	3396	Bush rocker arm	16	
24	293545	Pedestal rear.	1	
25	300670	Spring front and rear	2	
26	300669	Spring centre	1	
27	11506	Screw	1	
28	10485	Shakeproof washer	1	
29	237	Exhaust valve with 3/8" stem diameter	4	} TR2 to TR3A, TR4 to engine no. CT21470
30	1252	Valve guide with 3/8" stem diameter	4	
29	275	Exhaust valve with 5/16" stem diameter.	4	} TR4 from engine no. CT21471, TR4A
30	3408	Valve guide with 5/16" stem diameter	4	
31	313093	Valve spring cap	4	
32	4764	Valve spring exhaust valve	4	} TR2 to TR3A, TR4 to engine no. CT21470
33	291296	Valve spring exhaust and inlet valve - inner	8	
34	290195	Valve spring exhaust and inlet valve - outer.	8	} All cars

1.5

Engine

Cylinder head

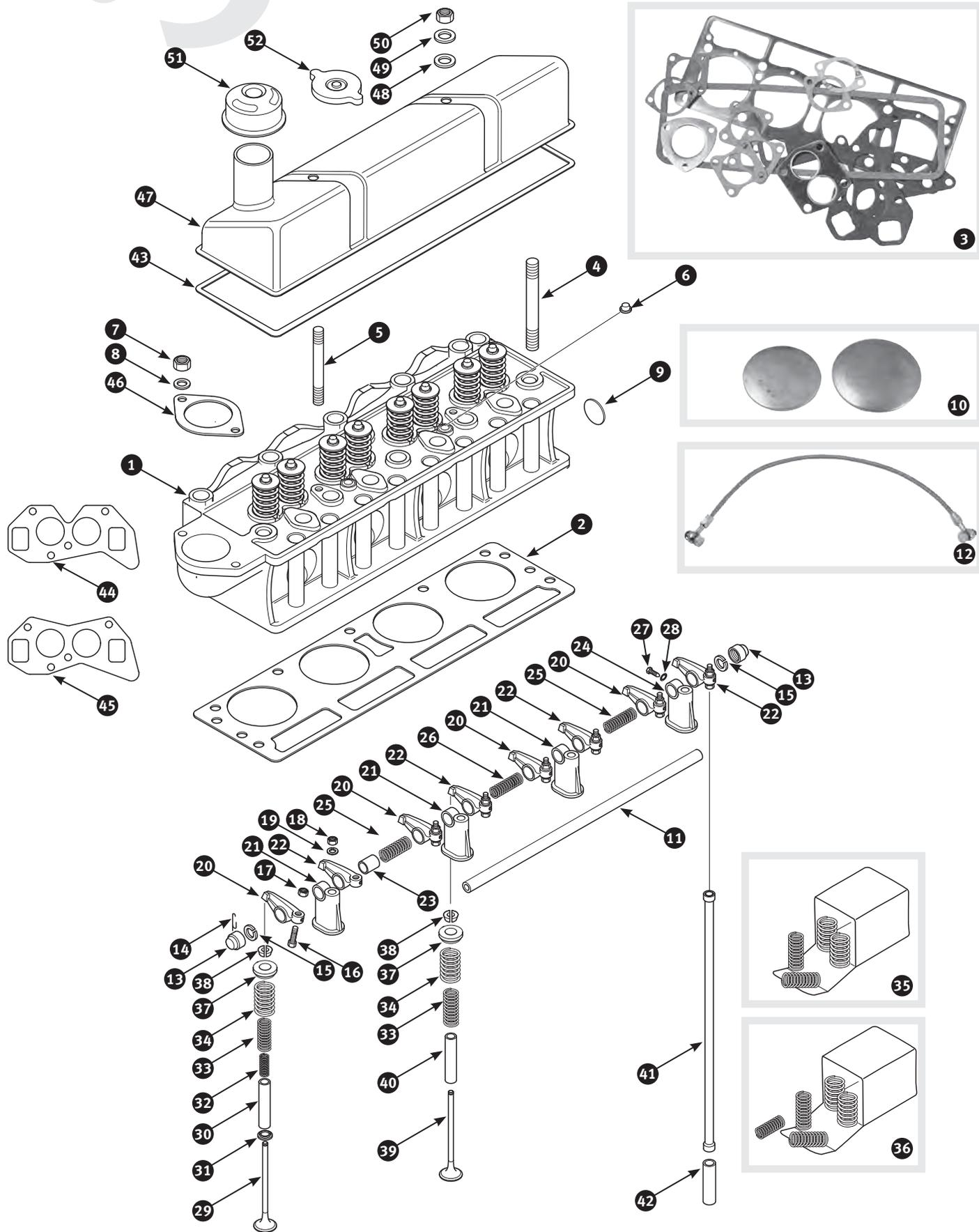

No	Part No	Description	Qty	Notes
35	1098	Valve springs - complete car set with double exhaust and inlet valve springs.	1	} TR4 from engine no. CT21471, TR4A
36	1097	Valve springs - complete car set with triple exhaust and double inlet valve springs	1	
37	21389	Valve spring cap for triple exhaust and double inlet valve springs .8	.8	} TR2 to TR3A, TR4 to engine no. CT21470
37	289667	Valve spring cap for double exhaust and inlet valve springs		
38	5080	Valve cotter	16	} TR4 from engine no. CT21471, TR4A
39	235	Inlet valve	4	
40	3408	Valve guide inlet valve	4	
41	233	Push rod	8	
42	2988	Cam follower standard	8	} Alternatives
42	12868	Cam follower tufride	8	
42	363161	Cam follower lightweight	8	
43	974	Rocker cover gasket	1	
44	2354	Manifold gasket for low port cylinder head	2	} TR2, TR3 to engine no. TS13051
45	201058	Manifold gasket for high port cylinder head.	2	
46	9780	Gasket thermostat housing to cylinder head.	1	} TR3 from engine no. TS13052, TR3A to TR4A
47	15504	Rocker cover - identify by breather in oil filler cap	1	
47	469403	Rocker cover - identify by breather in oil filler cap	1	} TR2 to TR3A
47	306527	Rocker cover - identify by breather in rocker cover	1	
48	9418	Fibre washer	2	} TR4
49	212193	Plain washer	2	
50	7455	Nyloc nut	2	
51	9568	Oil filler cap with breather	1	} TR2 to TR4
52	2149	Oil filler cap without breather	1	
52	9568	Oil filler cap without breather	1	} TR4A



Clickadjust
with micrometer. Adjust tappets precisely, count the clicks for exact micro adjustment, no need to use a feeler gauge.
Part no. 313529



1.6

Engine

Oil filter - Purolator ,bypass' type

TR2, TR3 to engine no. TS9951E

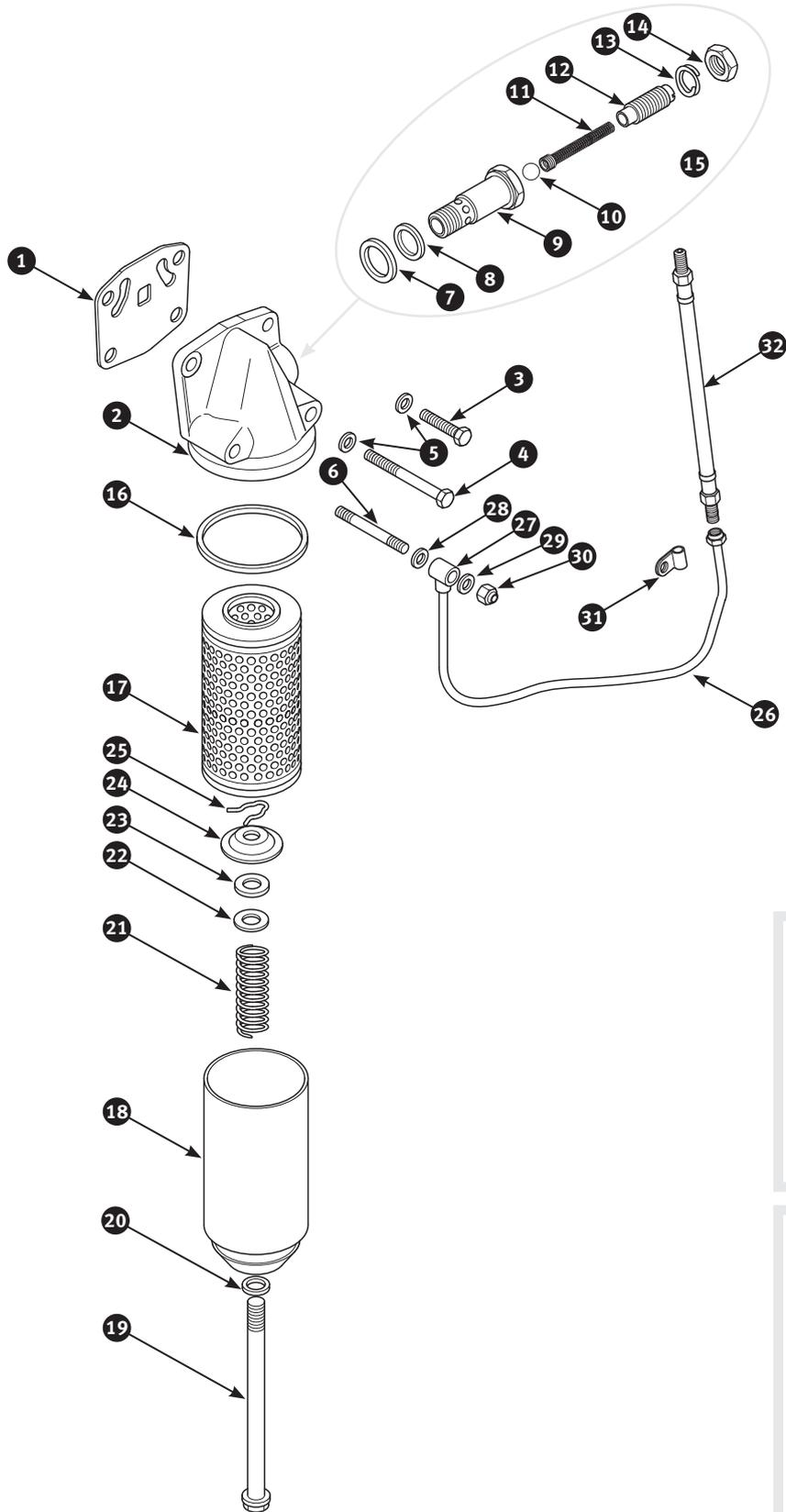

No	Part No	Description	Qty	Notes
1	2366	Gasket oil filter head to cylinder block.	1	
2	362070	Oil filter head Purolator - ,bypass' type	1	
3	212167	Screw oil filter head - upper fixing	2	
4	212033	Bolt oil filter head - lower rear fixing.	1	
5	212194	Spring washer oil filter head.	3	
6	5096	Stud oil filter head - lower front fixing and banjo fitting	1	
7	20876	Sealing ring	1	
8	10575	Washer	1	
9	327483	Body oil pressure valve	1	
10	11304	Steel ball oil pressure valve	1	
11	11258	Spring oil pressure valve	1	
12	3438	Adjusting screw oil pressure valve.	1	
13	3310	Lead linger adjusting screw sealing.	1	} Supplied per metre
14	255006	Nut	1	
15	464086	Oil pressure valve assembly	1	
16	8421	Sealing ring oil filter bowl to filter head.	1	
17	1008	Oil filter element - paper	1	} Alternatives
17	290806	Oil filter element - micro filter.	1	
18	327100	Oil filter bowl used item.	1	
19	256064	Bolt oil filter bowl to filter head	1	
20	3139	Rubber washer	1	
21	203351	Compression spring	1	
22	255155	Rubber washer	1	
23	9253	Rubber seal	1	
24	20444	Pressure plate	1	
25	8921	Circlip	1	
26	10836	Oil pipe including banjo - oil filter head to oil hose	1	
27	10837	Banjo union pipe to oil filter head	1	
28	12064	Copper washer oil pipe to oil filter head - inner	1	
29	13407	Copper washer oil pipe to oil filter head - outer.	1	
30	349279	Dome nut oil pipe to filter head	1	
31	255750	Clip oil pipe to block.	1	} Fixed at fuel pump stud
32	2343	Oil hose oil pipe to bulkhead - stainless steel braided	1	
33	25212	Oil filter adaptor	1	} For spin on conversion
34	18198	Oil filter	1	

For Triumph

- FilterMAG standard. 481133
- FilterMAG high performance 481135

FilterMAG's
powerfull rare-earth magnets trap and hold wear-inducing metal particles smaller than 40 microns down to 1 micron that the filter cannot stop. It extends oil life and reduces maintenance costs. Easy fitting while magnetic force „snaps“ FilterMAG to the filter canister. FilterMAG has a lifetime warranty.



1.7

Engine

Oil filter - Purolator ,full flow' type

TR3 from engine no. TS9952E, all TR4

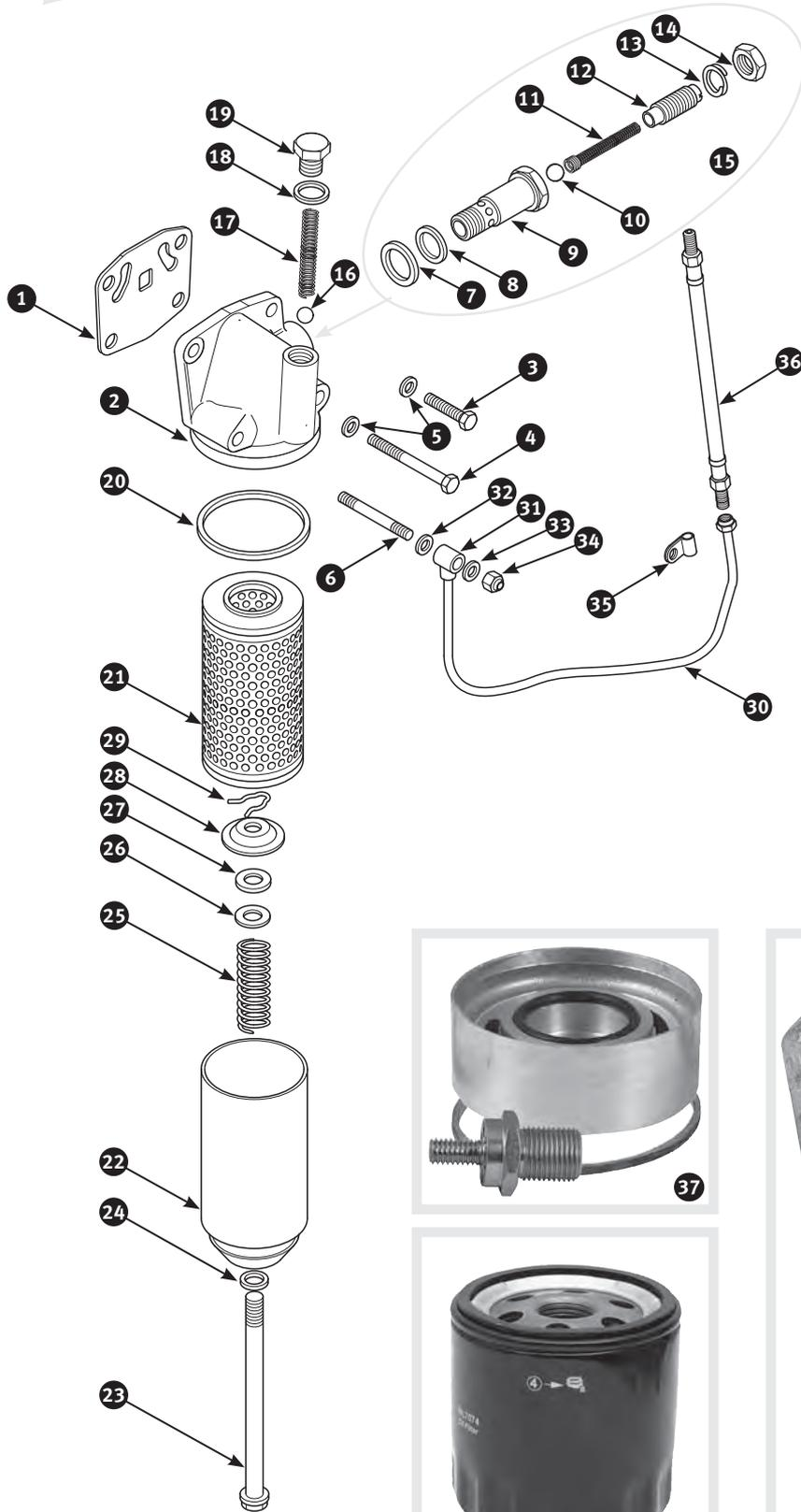

No	Part No	Description	Qty	Notes
1	2366	Gasket oil filter head to cylinder block.	1	
2	216213	Oil filter head used item.	1	
3	10717	Bolt oil filter head - upper front fixing	2	
4	212033	Bolt oil filter head - lower rear fixing.	1	
5	212194	Spring washer	3	
6	5096	Stud oil filter head - lower front fixing and banjo fitting	1	
7	20876	Sealing ring	1	
8	10575	Washer	1	
9	327483	Body oil pressure valve	1	
10	11304	Steel ball oil pressure valve - 27/64".	1	
11	11258	Spring oil pressure valve	1	
12	3438	Adjusting screw	1	
13	3310	Lead linger adjusting screw sealing.	1	} Supplied per metre
14	255006	Nut	1	
15	464086	Oil pressure valve assembly	1	
16	11304	Steel ball balance valve	1	
17	256063	Spring balance valve	1	
18	343004	Copper washer	1	
19	470007	Blanking plug balance valve.	1	
20	8421	Sealing ring oil filter bowl to oil filter head	1	
21	1008	Oil filter element - paper	1	} Alternatives
21	290806	Oil filter element - micro filter.	1	
22	327100	Oil filter bowl used item.	1	
23	295363	Bolt oil filter bowl to oil filter head.	1	
24	3139	Rubber washer	1	
25	203351	Compression spring	1	
26	255155	Rubber washer	1	
27	9253	Rubber seal	1	
28	20444	Pressure plate oil filter.	1	
29	8921	Circlip bolt oil filter bowl	1	
30	10836	Oil pipe including banjo - oil filter head to oil hose	1	
31	10837	Banjo union pipe to filter head.	1	
32	12064	Copper washer oil pipe to filter head - inner	1	
33	13407	Copper washer oil pipe to filter head - outer	1	
34	349279	Dome nut oil pipe to filter head	1	
35	255750	Clip oil pipe to block.	1	} Fixed at fuel pump stud
36	2343	Oil hose oil pipe to bulkhead - stainless steel braided	1	
37	25212	Oil filter adaptor	1	} For spin on conversion
38	18198	Oil filter	1	
39	216212	Oil filter head with oil filter bowl assembly - used item.	1	



Castrol Classic
 XL20W/50
 5 litres - part no. 480855
 4.5 litres - part no. 329066



Penrite
 HPR30 - 5 litres - part no. 22856

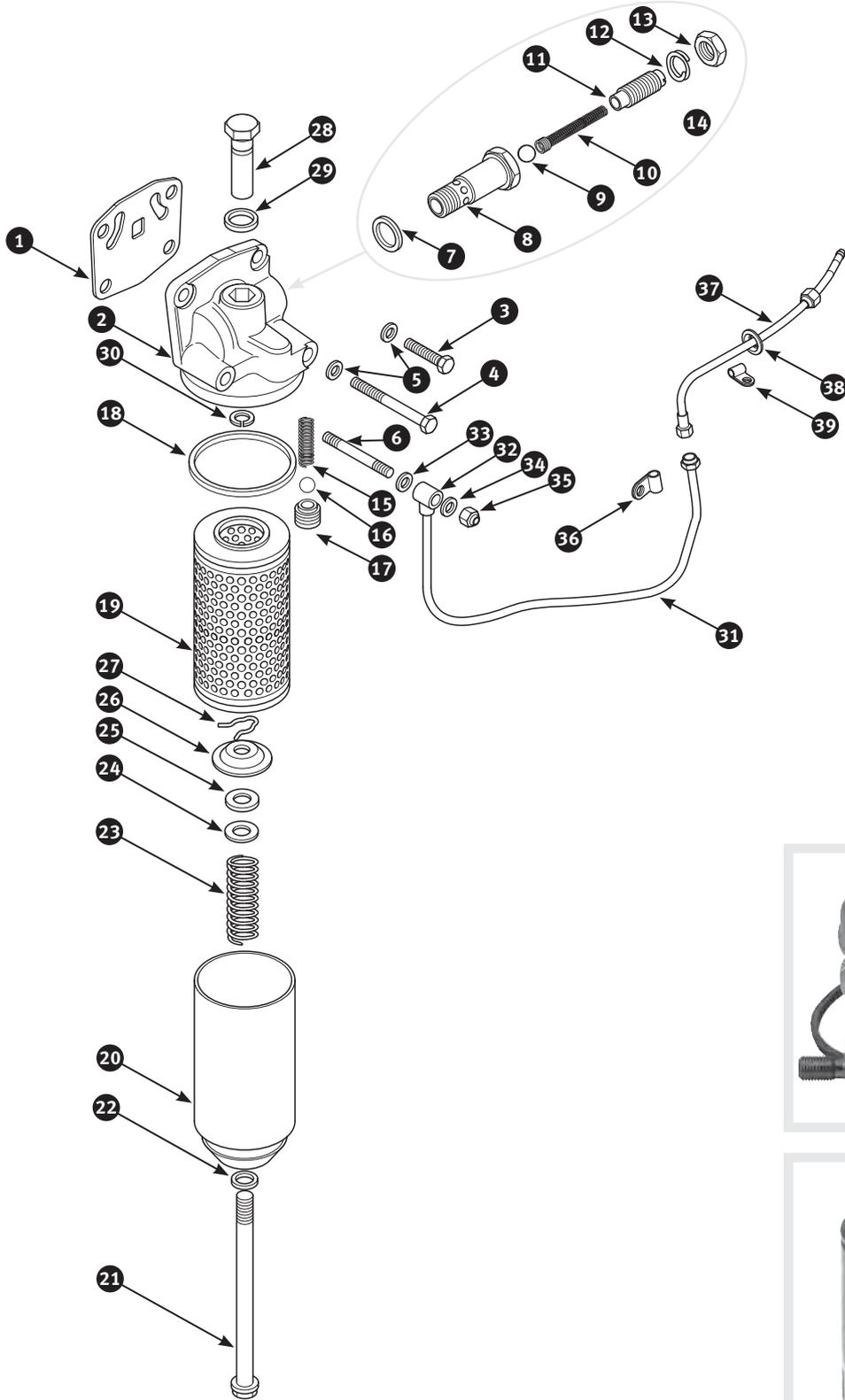

No	Part No	Description	Qty	Notes
1	2366	Gasket oil filter head to cylinder block.	1	
2	466217	Oil filter head	1	
3	10717	Bolt oil filter head - upper fixing	2	
4	212033	Bolt oil filter head - lower rear fixing.	1	
5	212194	Spring washer	3	
6	5096	Stud oil filter head - lower front fixing and banjo fitting	1	
7	297984	Sealing ring	1	
8	293836	Body oil pressure valve	1	
9	203121	Steel ball oil pressure valve	1	
10	300625	Spring oil pressure valve	1	
11	293837	Adjusting screw	1	
12	3310	Lead linger adjusting screw sealing.	1	} Supplied per metre
13	300727	Nut	1	
14	464086	Oil pressure valve assembly	1	
15	289804	Spring balance valve	1	
16	203121	Steel ball balance valve	1	
17	12455	Valve seat balance valve	1	
18	299636	Sealing ring	1	
19	1008	Oil filter element - paper	1	} Alternatives
19	290806	Oil filter element - micro filter.	1	
20	12456	Oil filter bowl	1	
21	372943	Bolt oil filter bowl to filter head	1	
22	18105	Sealing rubber	1	
23	342989	Spring	1	
24	485053	Washer	1	
25	485054	Felt washer	1	
26	5424	Pressure plate oil filter.	1	
27	8921	Circlip	1	
28	485055	Nut	1	
29	470733	Sealing ring	1	
30	362077	Retaining clip	1	
31	10836	Oil pipe including banjo - oil filter head to oil hose	1	
32	10837	Banjo union pipe to filter head	1	
33	12064	Copper washer oil pipe to filter head - inner	1	
34	13407	Copper washer oil pipe to filter head - outer	1	
35	349279	Dome nut oil pipe to filter head	1	
36	255750	Clip oil pipe to cylinder block.	1	} Fixed at fuel pump stud
37	9699	Oil feed pipe nylon - engine to oil pressure gauge	1	
38	22735	Grommet oil pipe through bulkhead	1	
39	3424	Clip oil pipe to bulkhead	1	
40	3117	Oil filter adaptor	1	} For spin on conversion
41	18198	Oil filter	1	

4 Catalogues, you must have:

- Oils and lubricants
- Tuning and more
- Accessories
- Tools



Order online: www.Limora.com • www.scparts.co.uk

1.9

Engine

Engine mountings

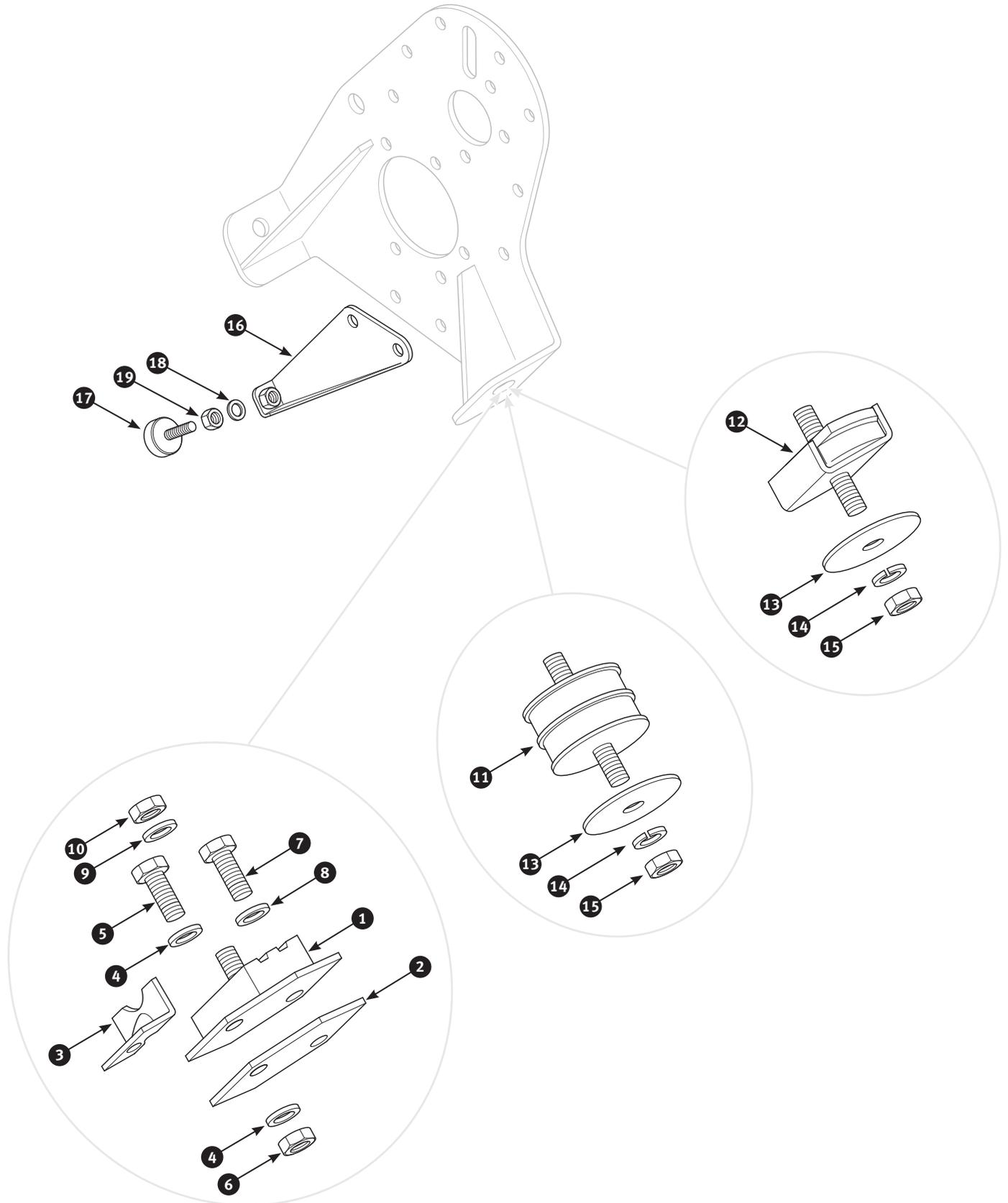

No	Part No	Description	Qty	Notes
1	3422	Engine mounting	2	} TR2, TR3, TR3A and TR3B
2	21390	Pad engine mounting.	4	
3	20729	Bracket engine mounting	4	
4	212193	Plain washer engine mounting to chassis.	4	
5	7894	Screw engine mounting to chassis	2	
6	7455	Nyloc nut engine mounting to chassis	2	
7	7893	Screw engine mounting to chassis	2	
8	212194	Spring washer engine mounting to chassis.	2	
9	212195	Plain washer engine mounting to engine plate.	2	
10	2829	Nyloc nut engine mounting to engine plate	2	
11	1215	Engine mounting round	2	} TR4
12	1266	Engine mounting rectangular	2	
13	272	Packing washer engine mounting	4	} TR4, TR4A
14	212194	Spring washer engine mounting	4	
15	3073	Nut engine mounting.	4	
16	20837	Bracket	1	} TR4 variants with torque reaction arm
17	4763	Rubber buffer	1	
18	212194	Spring washer	1	
19	2303	Nut	1	



Axle stands

3,6 ton (1800 kg each), height adjustable from 255 to 370 mm, solid stand, foldable
Part no. 312445



Digital exhaust CO analyser with pulse pump

Professional edition with digital display for CO level, voltage, rpm, dwell, a collector-box with pulse pump, metal exhaust probe with retaining springs, 3 flexible pipes. Requires just DC 12 Volt and can be simply run off a regular car battery. The pulse pump just uses the pressure built up within the exhaust system, there actually isn't a moving part that could wear out or needs to be cleaned. Water gets separated in the built-in water trap. It is accurate to 0.5 % CO measurement and can be easily calibrated in air.
Part no. 321425

1.10

Engine

Engine breather system

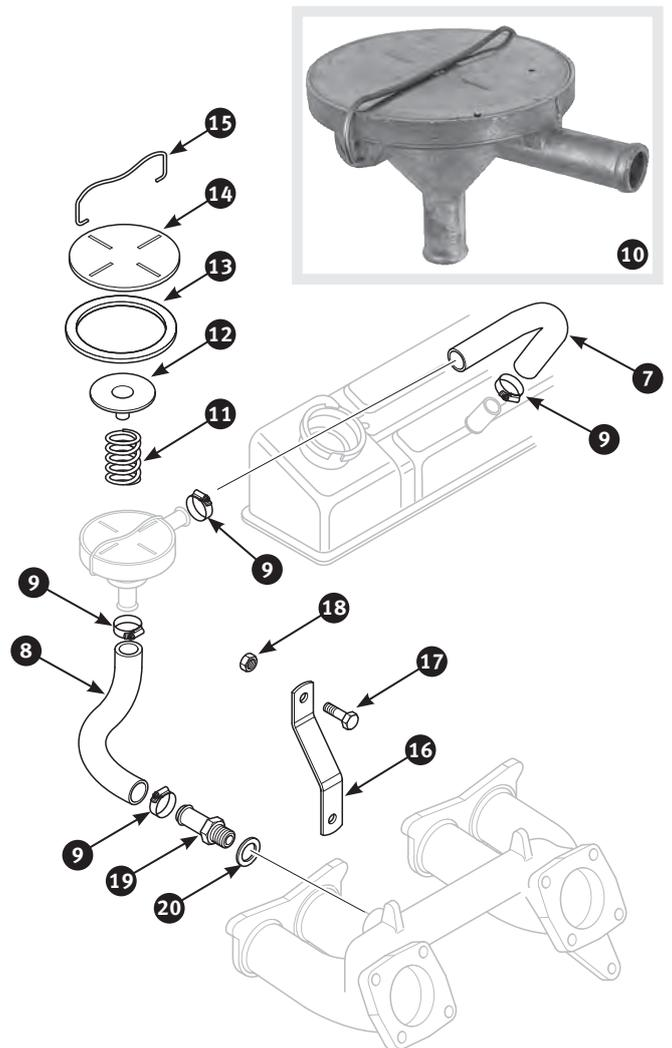
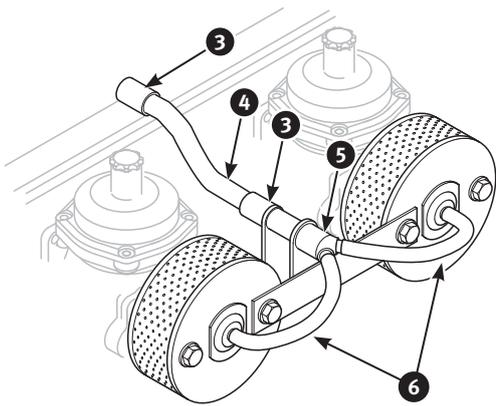
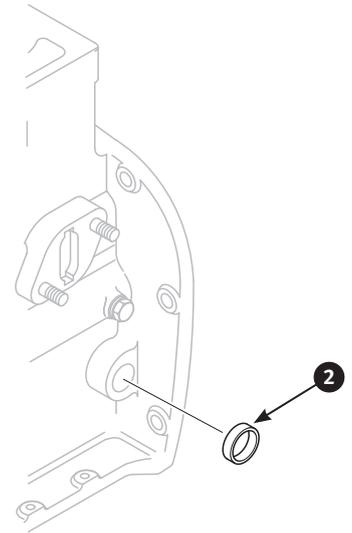
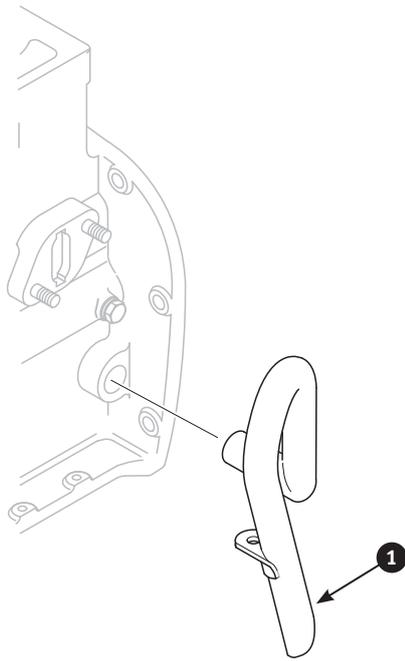

No	Part No	Description	Qty	Notes
1	312726	Breather pipe new item	1	} TR2, TR3, TR3A, TR3B, TR4 to engine no. CT25393E
1	25920	Breather pipe used item.	1	
2	19594	Blanking plug for engines with closed circuit breathing	1	} TR4 from engine no. CT23594E, TR4A
3	2412	Hose to rocker cover and flame trap	2	
4	300192	Pipe between rocker cover and flame trap	1	} TR4 from engine no. CT23594E
5	484904	Flame trap	1	
6	25275	Hose to air cleaner	2	} TR4A
7	9902	Hose rocker cover to control valve	1	
8	19371	Hose control valve to inlet manifold	1	
9	1611	Hose clip wire type	4	
9	3921	Hose clip worm type	4	
10	214736	Control valve engine breathing system	1	
11	292911	Compression spring control valve - separately	1	
12	5521	Plunger control valve - separately	1	
13	5171	Diaphragm control valve - separately.	1	
14	8939	Cover control valve - separately	1	
15	8940	Spring clip control valve - separately.	1	
16	10557	Bracket control valve	1	
17	3072	Screw	1	
18	212451	Nyloc nut	1	
19	329131	Adaptor hose to inlet manifold	1	
20	3053	Fibre washer	1	

Order free of charge:



Tools catalogue



Colortune

Allows you to see the colour of combustion in your cylinders. The kit includes a special glass topped spark plug, reflective viewing system for difficult plug locations, cleaning supplies and instructions.
part no. 19831



Crank case breather filter

external inlet pipe for 1/2" hose, diameter: 51 mms, height: 38 mm
Part no. 317467

2.1

Gearbox and overdrive Gearbox, 3 synchro outer - TR2 to TR3A

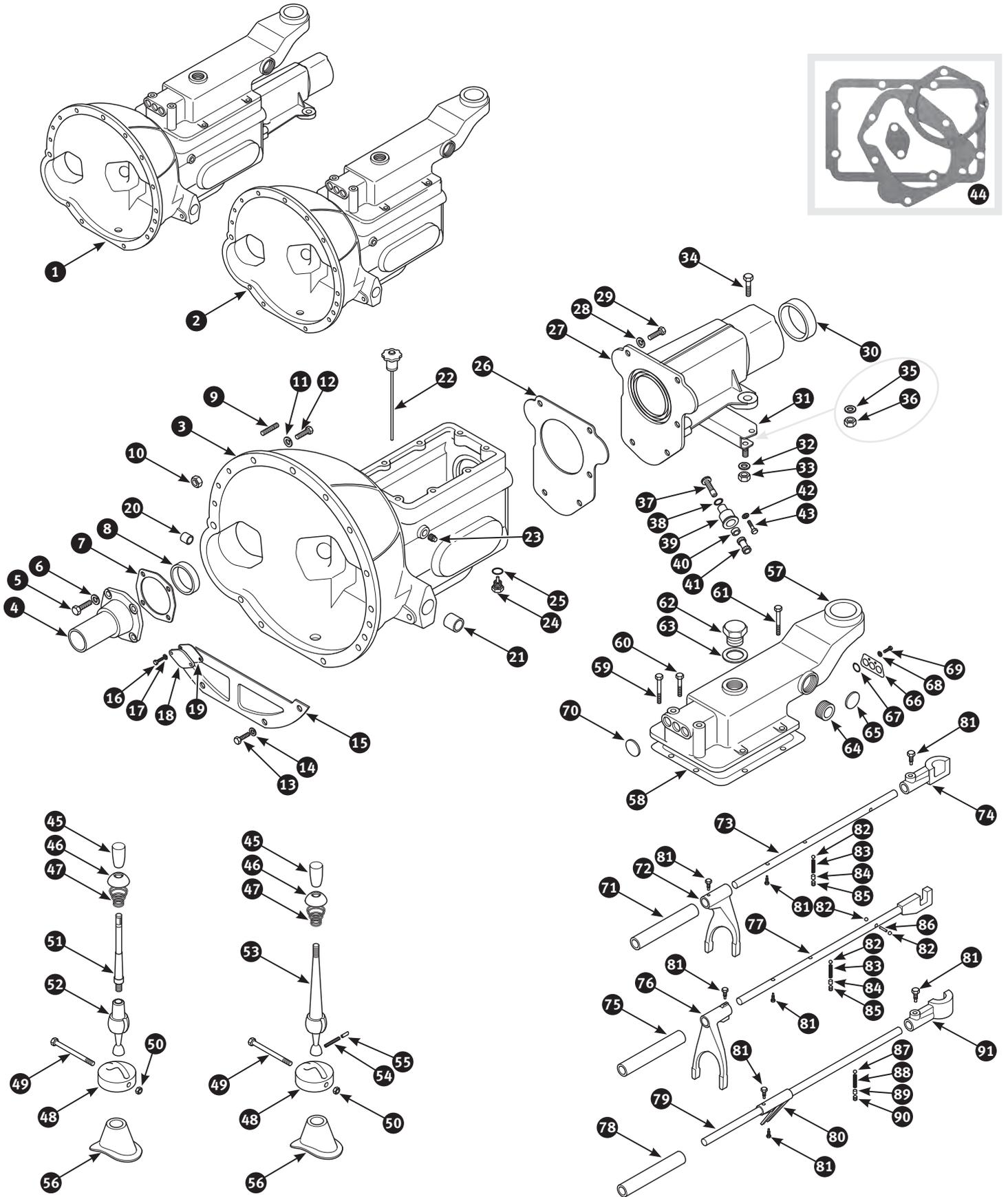

No	Part No	Description	Qty	Notes
1	210054	Gearbox non Overdrive specification	1	TR2 and TR3, TR3A to TS50000. Identification: clutch housing adapts early ,Bomb' type starter motor
2	327447	Gearbox Overdrive specification	1	
1	279121	Gearbox non Overdrive specification	1	TR3A from TS50001. Identification: clutch housing adapts late ,Long' type starter motor
2	446954	Gearbox Overdrive specification	1	
3	16212	Gearbox casing	1	TR2 and TR3, TR3A to TS50000 TR3A from TS50001
3	436711	Gearbox casing - identify by 11 mm mounting flange.	1	
4	207	Flange first motion shaft	1	
5	212165	Screw	6	
6	13407	Copper washer	6	
7	3427	Gasket	1	
8	283	Oil seal gearbox front	1	
9	200361	Stud starter motor to gearbox.	3	
10	3073	Nut	2	Starter motor to gearbox
11	2051	Spring washer	2	
12	213890	Bolt	2	
13	212167	Screw gearbox to cylinder block	6	
13	7893	Screw gearbox to clutch cover	2	
13	2826	Screw gearbox to clutch slave cylinder.	2	
14	212194	Spring washer	13	
15	214452	Cover clutch housing	1	
16	212165	Screw	6	
17	13407	Copper washer	6	
18	3342	Cover layshaft.	1	
19	2329	Gasket	1	
20	3332	Bush clutch shaft - RH side.	1	
21	3393	Bush clutch shaft - LH side.	1	
22	200939	Dipstick oil filler	1	TR2 and TR3, TR3A to TS50000 TR3A from TS50001
23	14245	Blanking plug oil filler	1	
24	14245	Blanking plug oil drain.	1	Alternatives
24	9521	Blanking plug oil drain - magnetic type	1	
25	13352	Copper crush washer use on magnetic oil drain plug	1	
26	4753	Gasket gearbox extension to gearbox casing	1	
27	21420	Gearbox housing rear extension	1	Non overdrive models only
28	212194	Spring washer	6	
29	212167	Screw - length: 1"	5	
29	6501	Bolt - length: 2"	1	
30	1032	Oil seal gearbox rear	1	
31	201009	Gearbox mounting rubber	1	
32	2215	Spring washer	2	
33	2869	Nut	2	
34	3776	Screw gearbox to mounting	1	
35	7461	Spring washer	2	
36	3809	Nut	2	
37	4762	Pinion speedo drive - 15 teeth	1	
38	327553	,O' ring	1	
39	10344	Bearing speedo drive gear	1	
40	11347	Oil seal	1	
41	371113	Screwed sleeve speedo drive	1	
42	212194	Spring washer	1	
43	214658	Bolt speedo drive retaining	1	
44	2462	Gearbox gasket set	1	
45	300643	Gear knob push-on type.	1	TR2 to TS2875
45	20855	Gear knob screw-on type	1	
45	20855	Gear knob screw-on type	1	TR2 from TS2876, TR3, TR3A to TS50000 TR3A from TS50001
46	5097	Retainer	1	
47	9733	Spring	1	
48	10554	Cap gear lever - new item	1	
48	214316	Cap gear lever - used item	1	

2.1

Gearbox and overdrive Gearbox, 3 synchro outer - TR2 to TR3A

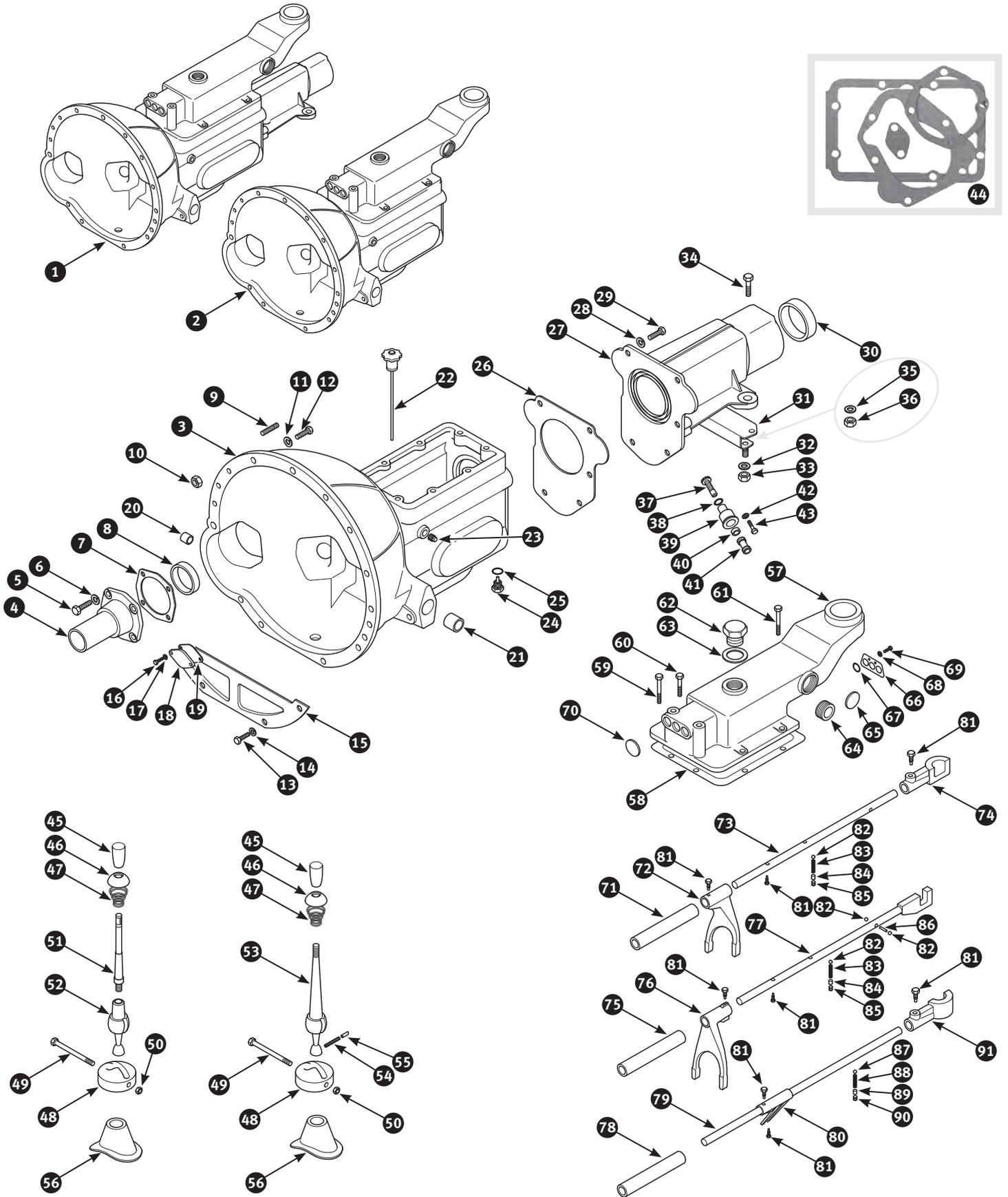

No	Part No	Description	Qty	Notes
49	315904	Bolt	1	
50	212451	Nyloc nut	1	
51	300645	Gear lever - upper section	1	TR2 to TS2875
52	300644	Gear lever - lower section	1	
53	20873	Gear lever	1	TR2 from TS2876, TR3 and TR3A
54	256	Spring plunger	1	
55	13060	Plunger	1	
56	2495	Gear lever grommet	1	
57	322440	Remote control housing - new item	1	
57	3040	Remote control housing - used item	1	
58	230	Gasket remote control housing	1	
59	10718	Bolt front	2	
60	3343	Bolt side	4	
61	212033	Bolt rear	2	
62	16864	Screw plug to blank switch holes	0	Quantity as required
63	25950	Copper crush washer	0	
64	300832	Screw plug side	1	
65	3340	Core plug side	1	
66	2960	Retainer ,O' ring	1	
67	10986	,O' ring selector shaft	3	
68	212192	Spring washer	2	
69	7884	Screw	2	
70	14280	Plug selector shaft	3	
71	300660	Sleeve 1st and 2nd selector shaft	1	TR3A from TS50001
72	300664	Selector fork 1st and 2nd speed	1	
73	300662	Selector fork rod 1st and 2nd speed	1	
74	322441	Gear selector lever 1st and 2nd speed - new item	1	
74	19064	Gear selector lever 1st and 2nd speed - used item	1	
75	5110	Sleeve 3rd and 4th selector shaft	1	TR3A from TS50001
76	202891	Selector fork 3rd and 4th speed	1	
77	315444	Selector fork rod 3rd and 4th speed - new item	1	
77	19033	Selector fork rod 3rd and 4th speed - used item	1	
78	300661	Sleeve reverse selector shaft	1	TR3A from TS50001
79	17140	Selector shaft reverse speed	1	
80	300665	Selector fork reverse speed	1	
81	9852	Screw retaining selector fork	8	Use without wire locking
82	17623	Steel ball	4	
83	10677	Compression spring	2	Detent selector shaft on 1st to 4th speed
84	14501	Distance piece	2	
85	5086	Screw plug	2	
86	5071	Interlocking pin selector shaft 3rd and 4th speed	1	
87	12826	Plunger	1	Detent reverse selector shaft
88	5079	Spring	1	
89	14501	Distance piece	1	
90	5086	Screw plug	1	
91	9582	Gear selector lever reverse speed - new item	1	
91	315443	Gear selector lever reverse speed - used item	1	

2.2

Gearbox and overdrive Gearbox, 3 synchro inner - TR2 to TR3A

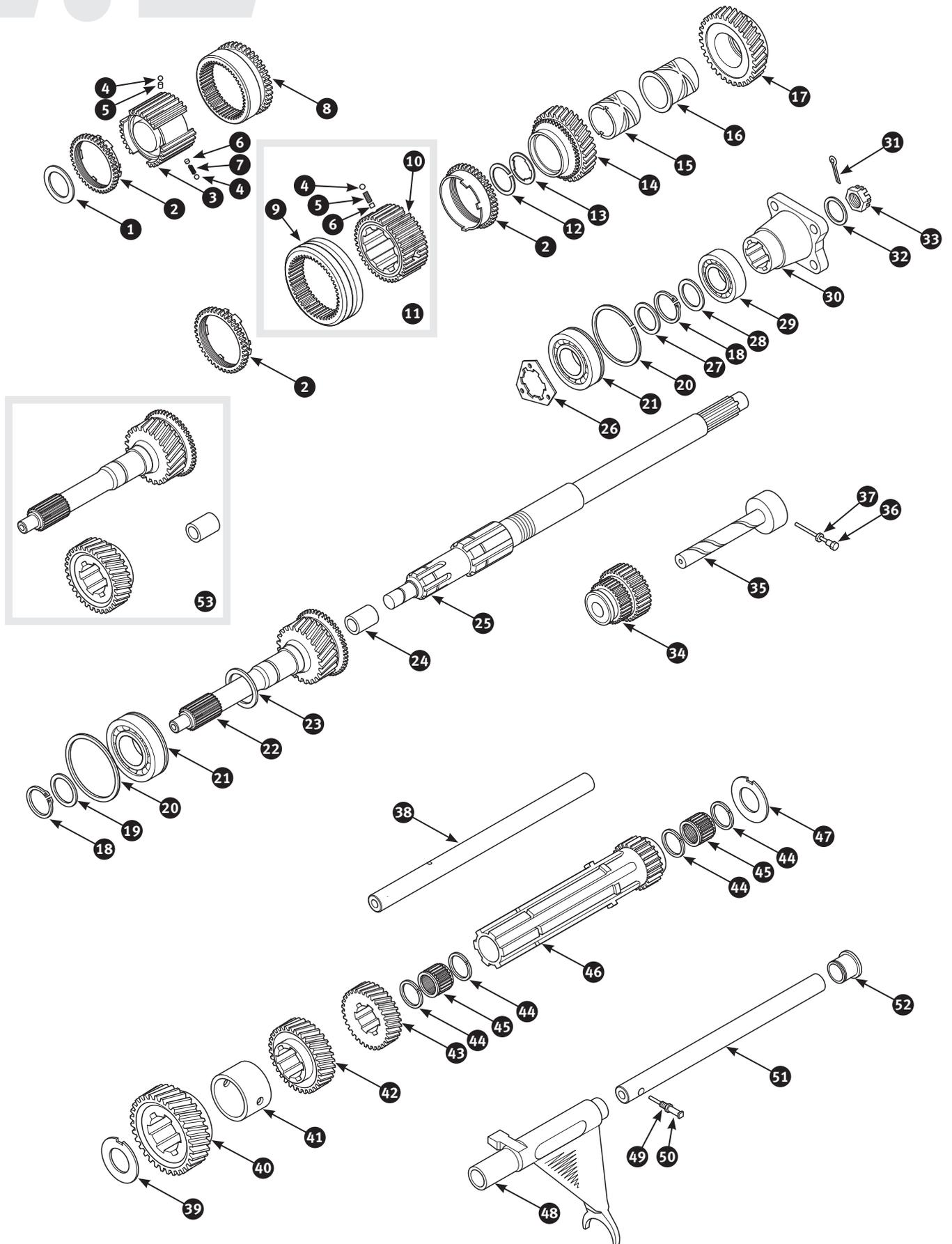

No	Part No	Description	Qty	Notes
1	300235	Locking washer	1	
2	248	Baulk ring	3	
3	17048	Synchro hub 1st speed - inner section	1	
4	6906	Steel ball synchro hub	7	
5	256	Spring	6	
6	14652	Shim	0	Quantity as required
7	11501	Interlocking pin	1	
8	16568	Gear 1st speed	1	
9	313527	Synchro hub sleeve - 3rd and 4th speed	1	
10	310	Synchro hub inner section - 3rd and 4th speed	1	
11	316219	Synchro hub assembly 3rd and 4th speed - used item	1	
12	3397	Circlip	1	
13	10742	Thrust washer	1	
14	228	Gear 3rd speed - new item	1	
14	316076	Gear 3rd speed - used item	1	
15	2342	Bronze bush 3rd speed	1	
16	4904	Bronze bush 2nd speed	1	
16	14653	Steel bush 2nd speed - uprated version	1	
17	289391	Gear 2nd speed - new item	1	
17	316062	Gear 2nd speed - used item	1	
18	3410	Circlip	2	
19	2335	Shim mainshaft ball bearing	1	
20	3409	Circlip on bearing	1	
21	3403	Ball bearing mainshaft front	2	
22	294018	First motion shaft - new item	1	TR2 and TR3, TR3A to TS26824
22	316137	First motion shaft - used item	1	
22	18285	First motion shaft	1	TR3A from TS26825
23	3440	Oil thrower	1	
24	19497	Bronze bearing first motion shaft	1	TR2 and TR3, TR3A to TS26824
24	292	Needle bearing first motion shaft	1	
25	322438	Gearbox mainshaft - non overdrive type	1	TR2 and TR3, TR3A to TS26824
25	290199	Gearbox mainshaft - overdrive type	1	
25	294021	Gearbox mainshaft - non overdrive type	1	TR3A from TS26825
25	293324	Gearbox mainshaft - overdrive type	1	
26	322436	Spacing washer between 1st speed and mainshaft bearing	1	TR2 and TR3, TR3A to TS26824
26	214749	Spacing washer between 1st speed and mainshaft bearing	1	
27	3426	Shim	1	
28	299251	Spacing washer	1	
29	3935	Ball bearing mainshaft rear	1	
30	12065	Flange gearbox end - angular type	1	
30	300841	Flange gearbox end - round type	1	
31	7466	Split pin	1	
32	10974	Plain washer	1	
33	3351	Slotted nut	1	
34	4455	Gear reverse	1	



Laser-Tachometer

digital gauge with Laser RPM pick up. With 5 digit LCD-display and a measuring range from 2.5 up to 99,999 RPM, Accuracy: + 0.05%+1 RPM. The built in memory saves min. and max. RPM and the last measured value. With this special meter all rotating parts can be checked. Great diagnostic tool for gearbox, final drive and many other applications on automotive service and repair

Part no. 221361

2.2

Gearbox and overdrive Gearbox, 3 synchro inner - TR2 to TR3A

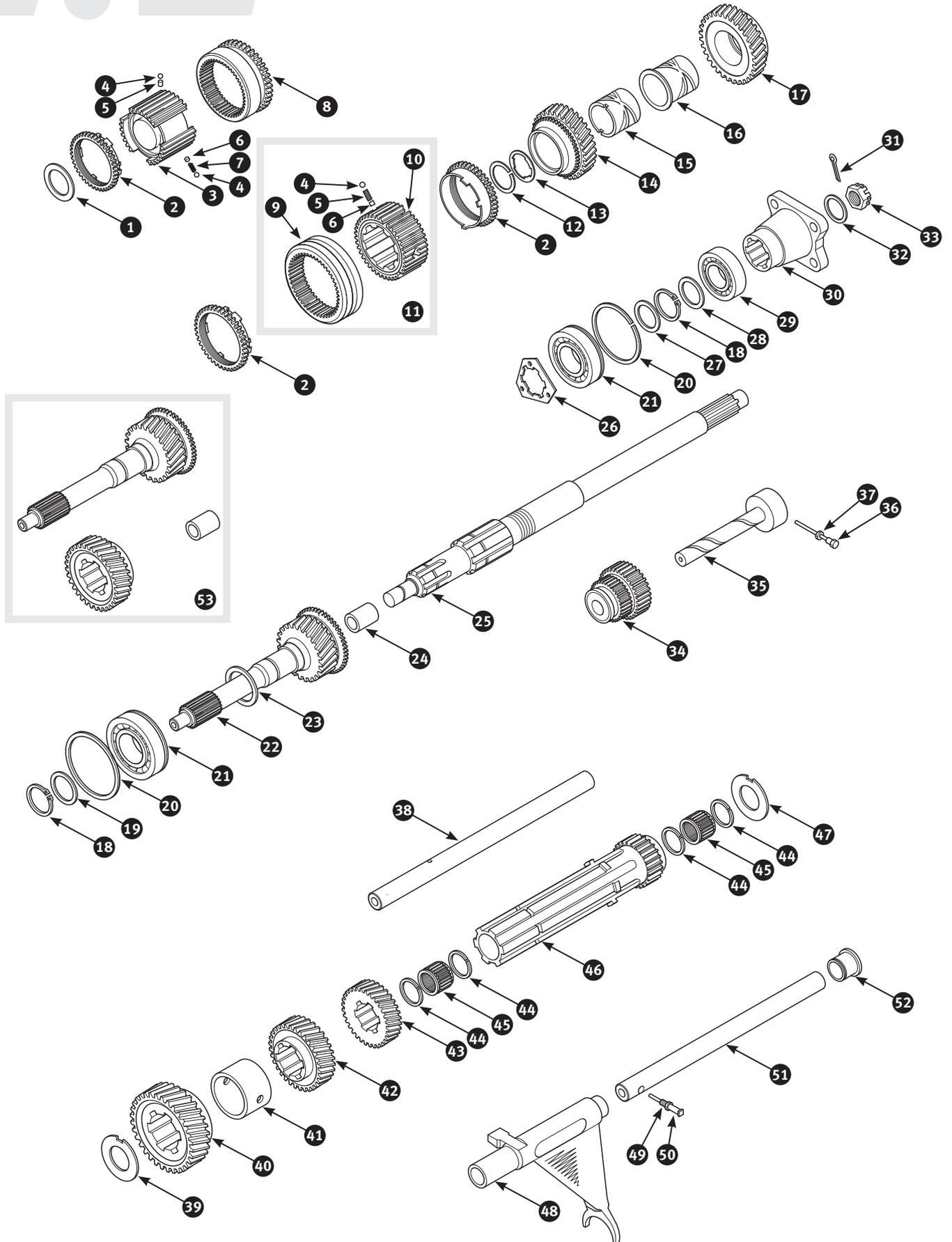

No	Part No	Description	Qty	Notes
35	293450	Shaft reverse gear	1	
36	289032	Bolt reverse gear shaft.	1	
37	212194	Spring washer	1	
38	9745	Lay shaft	1	
39	9789	Thrust washer	1	
40	9740	Gear constant mesh 4th speed	1	
41	21378	Distance piece lay gear	1	
42	9717	Gear 3rd speed - on lay shaft	1	
43	9741	Gear 2nd speed - on lay shaft.	1	
44	300621	Retaining ring needle bearing.	4	
45	3352	Needle lay gear	48	
46	9739	Lay gear	1	
47	9788	Thrust washer needle bearing rear	1	
48	300631	Selector fork reverse gear.	1	
49	9173	Locking nut	1	
50	11306	Bolt retaining selector shaft	1	
51	2348	Selector shaft reverse gear.	1	
52	300624	Bush reverse gear shaft	1	
53	1816	Gear set	1	Contains first motion shaft, constant gear with bush



Penrite Mild EP gear oil

an extreme pressure automotive gear oil meeting the requirements of API GL4 for moderate load applications. Mild EP is designed for use in all steel gear sets in Vintage and Classic cars as well as rack and pinion steering boxes of the 1950's and 1960's vehicles. It is suitable for use in spiral bevel, worm and pre 1960 hypoid axles. Also suitable for use in many gearboxes where a mild level of extreme prxsure protection is required. Benefits: protects against wear, good anti-friction characteristics, compatible with copper aooly components and protects against corrosion, can be used where either SAE90 or SAE140 grades are recommended. Penrite Mild EP gear oil meets the performance requirements of API GL-4 and MIL-L-2105. Please find further oils in chapter 21.26
1 litre bottle

Part no. 212132

4 Catalogues, you must have:

- Oils and lubricants
- Tuning and more
- Accessories
- Tools



Order online: www.Limora.com • www.scparts.co.uk

2.3

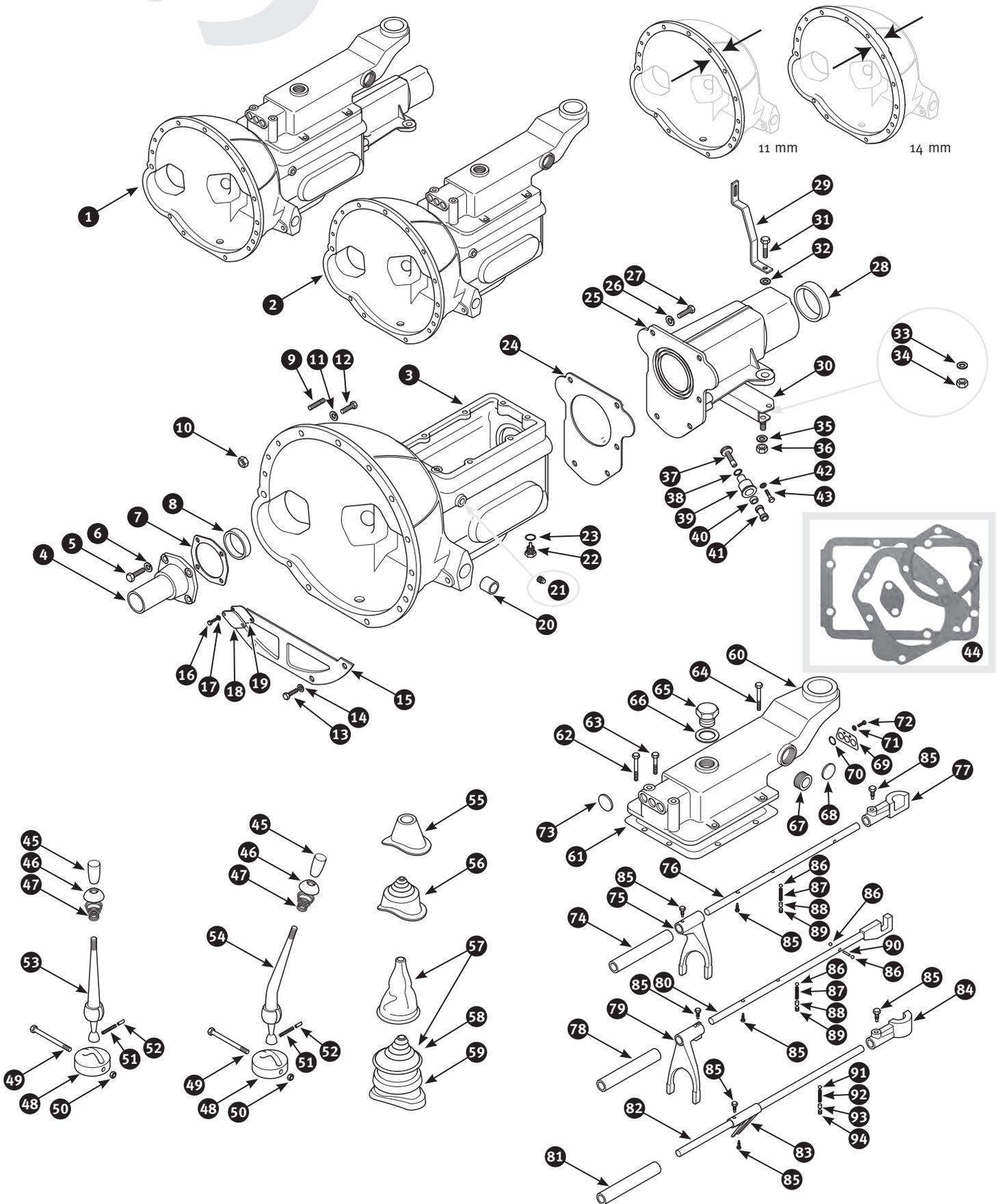

No	Part No	Description	Qty	Notes
1	287076	Gearbox non Overdrive specification	1	TR3B and early TR4. Identify by 11 mm gearbox mounting flange
2	327448	Gearbox Overdrive specification	1	
3	300705	Gearbox casing	1	
1	12622	Gearbox non Overdrive specification	1	late TR4, TR4A. Identify by 14 mm gearbox mounting flange
2	436644	Gearbox Overdrive specification	1	
3	214311	Gearbox casing	1	
4	207	Flange first motion shaft	1	
5	212165	Screw	6	
6	13407	Copper washer	6	
7	3427	Gasket	1	
8	283	Oil seal gearbox front	1	
9	200361	Stud starter motor to gearbox.	3	TR3B and early TR4. Identify by 11 mm gearbox mounting flange
10	3073	Nut starter motor to gearbox	2	
11	212194	Spring washer starter motor to gearbox.	2	
12	213890	Bolt starter motor to gearbox	2	
13	212167	Screw gearbox to cylinder block	6	
13	7893	Screw gearbox to clutch cover	2	
13	2826	Screw gearbox to clutch slave cylinder.	2	
14	212194	Spring washer	13	
9	318433	Stud starter motor to gearbox.	3	
10	3073	Nut starter motor to gearbox	2	
11	212194	Spring washer starter motor to gearbox.	2	
12	15514	Bolt starter motor to gearbox	2	
13	13109	Screw gearbox to cylinder block	6	
13	7893	Screw gearbox to clutch cover	2	
13	3381	Bolt gearbox to clutch slave cylinder.	2	
14	212194	Spring washer	13	
15	214452	Cover clutch housing	1	late TR4, TR4A. Identify by 14 mm gearbox mounting flange
16	212165	Screw	6	
17	13407	Copper washer	6	
18	3342	Cover layshaft.	1	
19	2329	Gasket	1	
20	3332	Bush clutch shaft - RH side - length: 7/8"	1	
20	3393	Bush clutch shaft - LH side - length: 7/8"	1	
20	26624	Bush clutch shaft - RH and LH side - length: 3/8"	2	
21	14245	Blanking plug oil filler	1	
22	9521	Blanking plug oil drain - magnetic type	1	
22	14245	Blanking plug oil drain.	1	
23	13352	Copper crush washer use on magnetic oil drain plug	1	
24	4753	Gasket gearbox extension to gearbox casing	1	



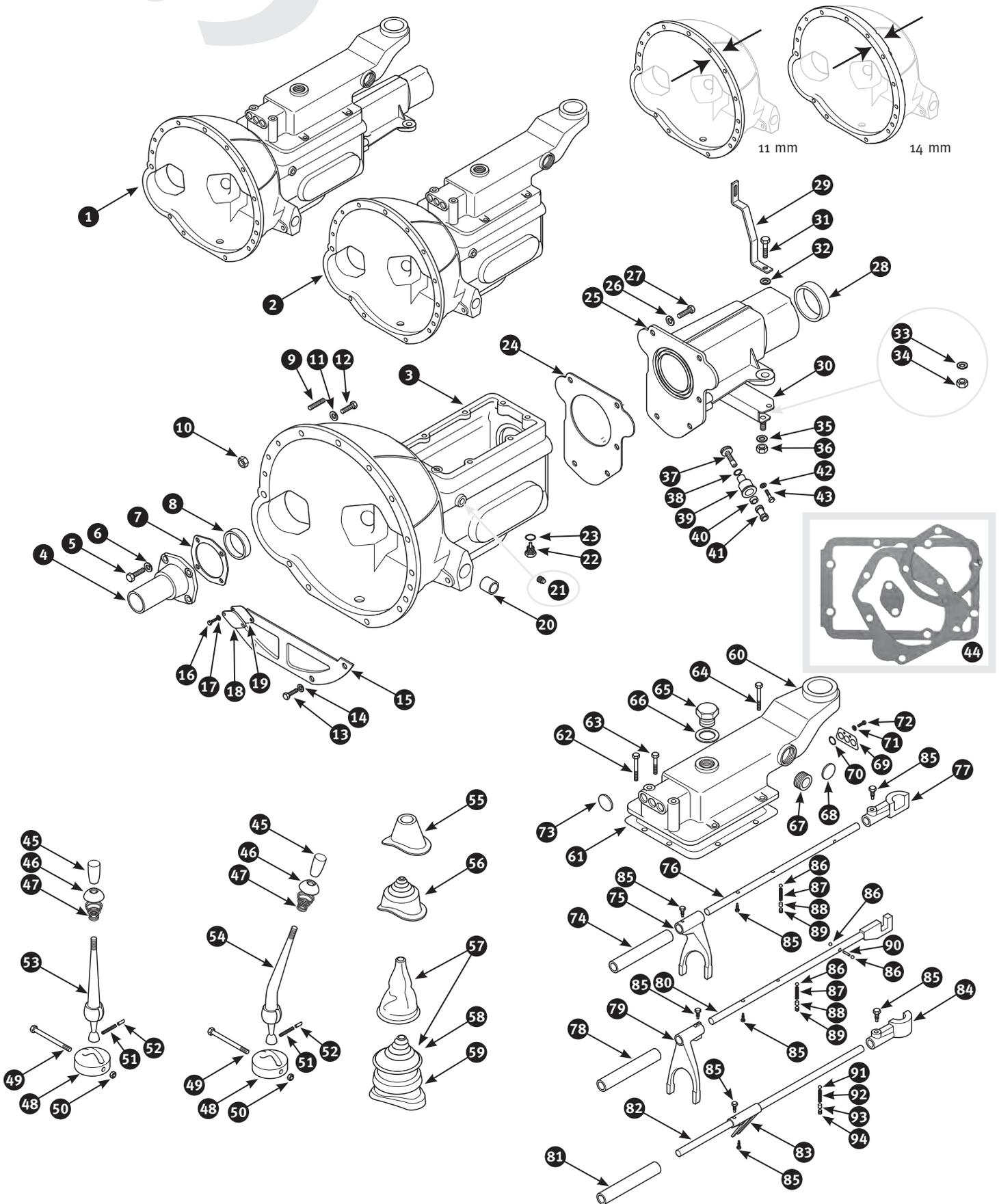

No	Part No	Description	Qty	Notes	
25	21420	Gearbox housing rear extension	1	} Non overdrive models only	
26	212194	Spring washer	6		
27	212167	Screw - length: 1"	5		
27	6501	Bolt - length: 2"	1		
28	1032	Oil seal gearbox rear	1		
29	20839	Strut remote control housing to gearbox	1		
30	201009	Gearbox mounting rubber	1		
31	3382	Bolt gearbox to mounting - RH side	1		
31	10733	Bolt gearbox to mounting - LH side	1		
32	13704	Spacing washer	1		
33	7461	Spring washer	2		
34	3809	Nut	2		
35	2215	Spring washer	2		
36	2869	Nut	2		
37	4762	Pinion speedo drive - 15 teeth	1		
38	327553	,O' ring	1		
39	10344	Bearing speedo drive gear	1		
40	11347	Oil seal	1		
41	371113	Screwed sleeve speedo drive	1		
42	212194	Spring washer	1		
43	214658	Bolt speedo drive retaining	1		
44	2462	Gearbox gasket set	1		
45	20855	Gear knob	1		} TR3B TR4 and TR4A
45	11414	Gear knob	1		
46	5097	Retainer	1		
47	9733	Spring	1		
48	10554	Cap gear lever - new item	1		
48	214316	Cap gear lever - used item	1		
49	315904	Bolt	1		
50	212451	Nyloc nut	1		
51	256	Spring plunger	1		
52	13060	Plunger	1		
53	20873	Gear lever	1		} TR2 from TS2876 to TR3B
53	214314	Gear lever	1		
54	214312	Gear lever	1		} TR4A
55	2495	Gear lever grommet	1		
56	2529	Gear lever grommet	1		} TR3B TR4
57	444	Gear lever gaiter with upper gear lever grommet assembly	1		
58	5378	Gear lever grommet upper	1		
59	459	Gear lever grommet lower	1		} TR4A
60	322440	Remote control housing - new item	1		
60	3040	Remote control housing - used item	1		
61	230	Gasket remote control housing	1		
62	10718	Bolt front	2		
63	3343	Bolt side	4		
64	212033	Bolt rear	2		
65	16864	Screw plug to blank switch holes	0	} Quantity as required	
66	25950	Copper crush washer	0		
67	300832	Screw plug side	1		

2.3

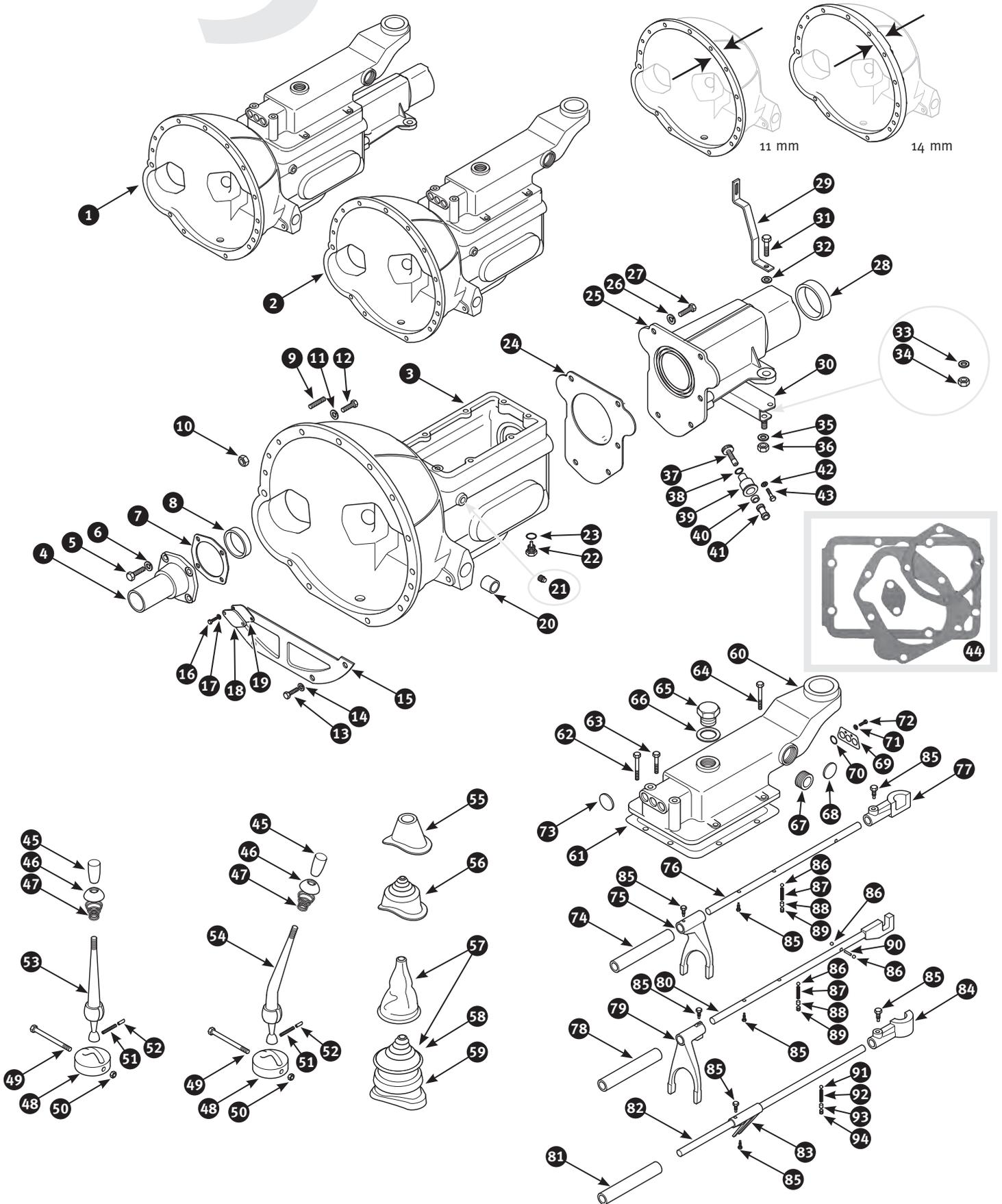

No	Part No	Description	Qty	Notes
68	3340	Core plug side.	1	
69	2960	Retainer ,O' ring	1	
70	10986	,O' ring selector shaft	3	
71	212192	Spring washer	2	
72	7884	Screw	2	
73	14280	Plug selector shaft.	3	
74	10621	Sleeve 1st and 2nd selector shaft	1	
75	261	Selector fork 1st and 2nd speed	1	
76	320	Selector fork rod 1st and 2nd speed	1	
77	322441	Gear selector lever 1st and 2nd speed - new item.	1	
77	19064	Gear selector lever 1st and 2nd speed - used item	1	
78	5110	Sleeve 3rd and 4th selector shaft	1	
79	202891	Selector fork 3rd and 4th speed	1	
80	315444	Selector fork rod 3rd and 4th speed - new item	1	
80	19033	Selector fork rod 3rd and 4th speed - used item	1	
81	290707	Sleeve shaft reverse selector fork	1	
82	17140	Selector shaft reverse speed.	1	
83	9680	Selector fork reverse speed	1	
84	9582	Gear selector lever reverse speed - new item	1	
84	315443	Gear selector lever reverse speed - used item	1	
85	9852	Screw retaining selector fork.	8	Use without wire locking
86	17623	Steel ball	4	
87	10677	Compression spring	2	Detent selector shaft on 1st to 4th speed
88	14501	Distance piece	2	
89	5086	Screw plug	2	
90	5071	Interlocking pin selector shaft 3rd and 4th speed.	1	Detent reverse selector shaft
91	12826	Plunger	1	
92	5079	Spring	1	
93	14501	Distance piece	1	
94	5086	Screw plug	1	



Castrol Gearbox oil EP90

mineral based, extreme pressure, multi-purpose gear oil. Primarily recommended for the lubrication of spur and helical gears where the manufacturer recommends an EP oil. Please find further oils in chapter 21.26

1 litre bottle

Part no.290203

2.4

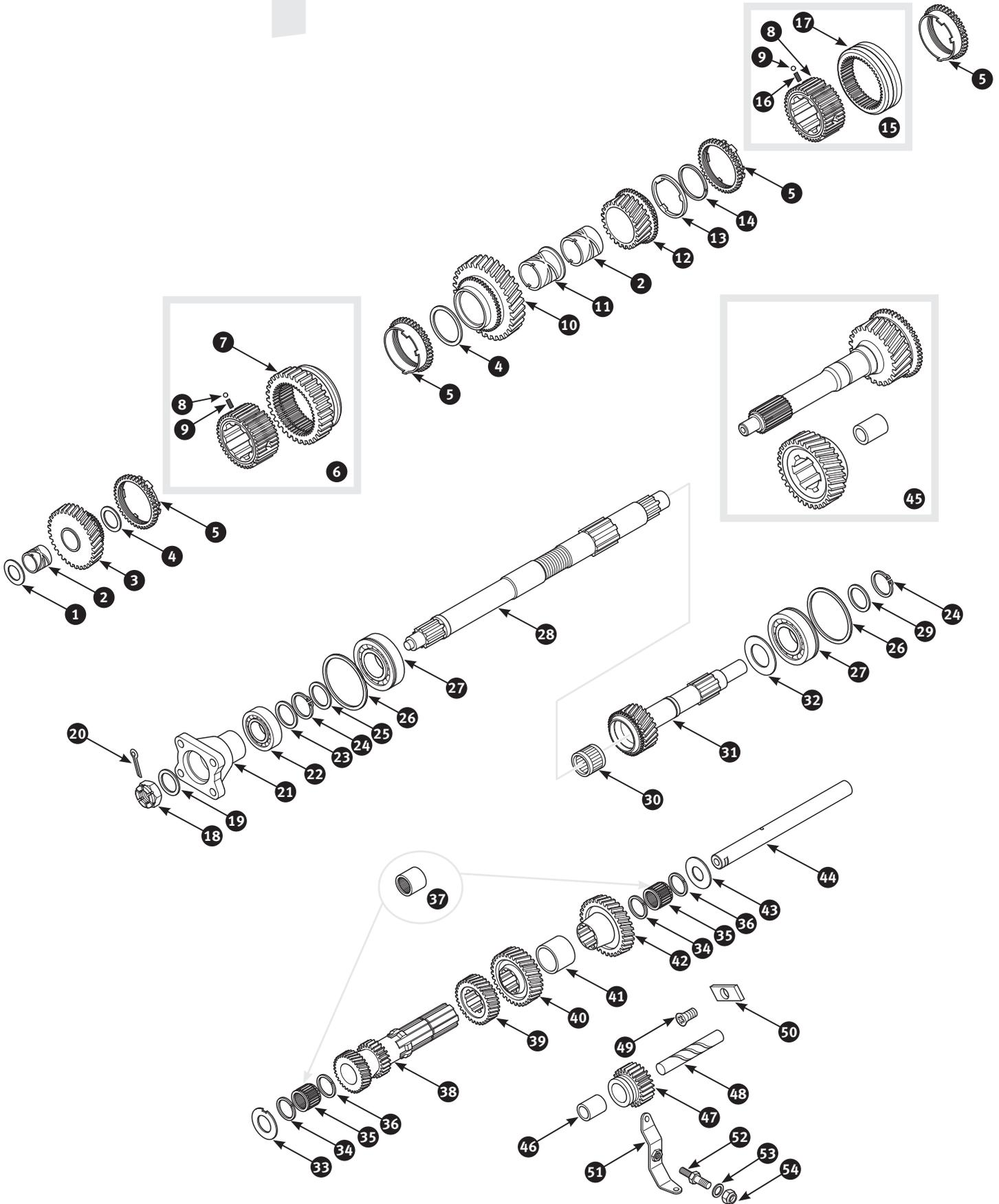

2.4

No	Part No	Description	Qty	Notes
1	214749	Spacing washer	1	
2	3162	Bronze bush 1st speed.	1	
3	201041	Gear 1st speed	1	
4	9682	Shim 0,118"	0	} Quantity as required
4	9683	Shim 0,121"	0	
4	26756	Shim 0,124"	0	
4	9684	Shim 0,127"	0	
4	293236	Shim 0,132"	0	
5	248	Baulk ring	4	
6	373	Synchro hub assembly 1st and 2nd speed - new item	1	
6	215997	Synchro hub assembly 1st and 2nd speed- used item	1	
7	1558	Synchro hub sleeve - 1st and 2nd speed	1	
8	6906	Steel ball synchro hub	6	
9	256	Spring	6	
10	289391	Gear 2nd speed.	1	
11	4904	Bronze bush 2nd speed	1	
11	14653	Steel bush 2nd speed - uprated version	1	
12	228	Gear 3rd speed	1	
13	10742	Thrust washer	1	
14	3397	Circlip	1	
15	316219	Synchro hub assembly 3rd and 4th speed used item	1	
16	310	Synchro hub inner section - 3rd and 4th speed	1	
17	313527	Synchro hub sleeve - 3rd and 4th speed	1	
18	3351	Slotted nut	1	
19	10974	Plain washer	1	
20	7466	Split pin	1	
21	300841	Flange gearbox end - round type	1	
21	12065	Flange gearbox end - angular type	1	
22	3935	Ball bearing mainshaft rear.	1	
23	299251	Spacing washer	1	
24	3410	Circlip	2	
25	3426	Shim	1	
26	3409	Circlip ball bearing.	2	
27	3403	Ball bearing mainshaft front.	2	
28	2423	Gearbox mainshaft - overdrive type.	1	
28	2966	Gearbox mainshaft - non overdrive type.	1	
29	2335	Shim mainshaft ball bearing.	1	

2.4

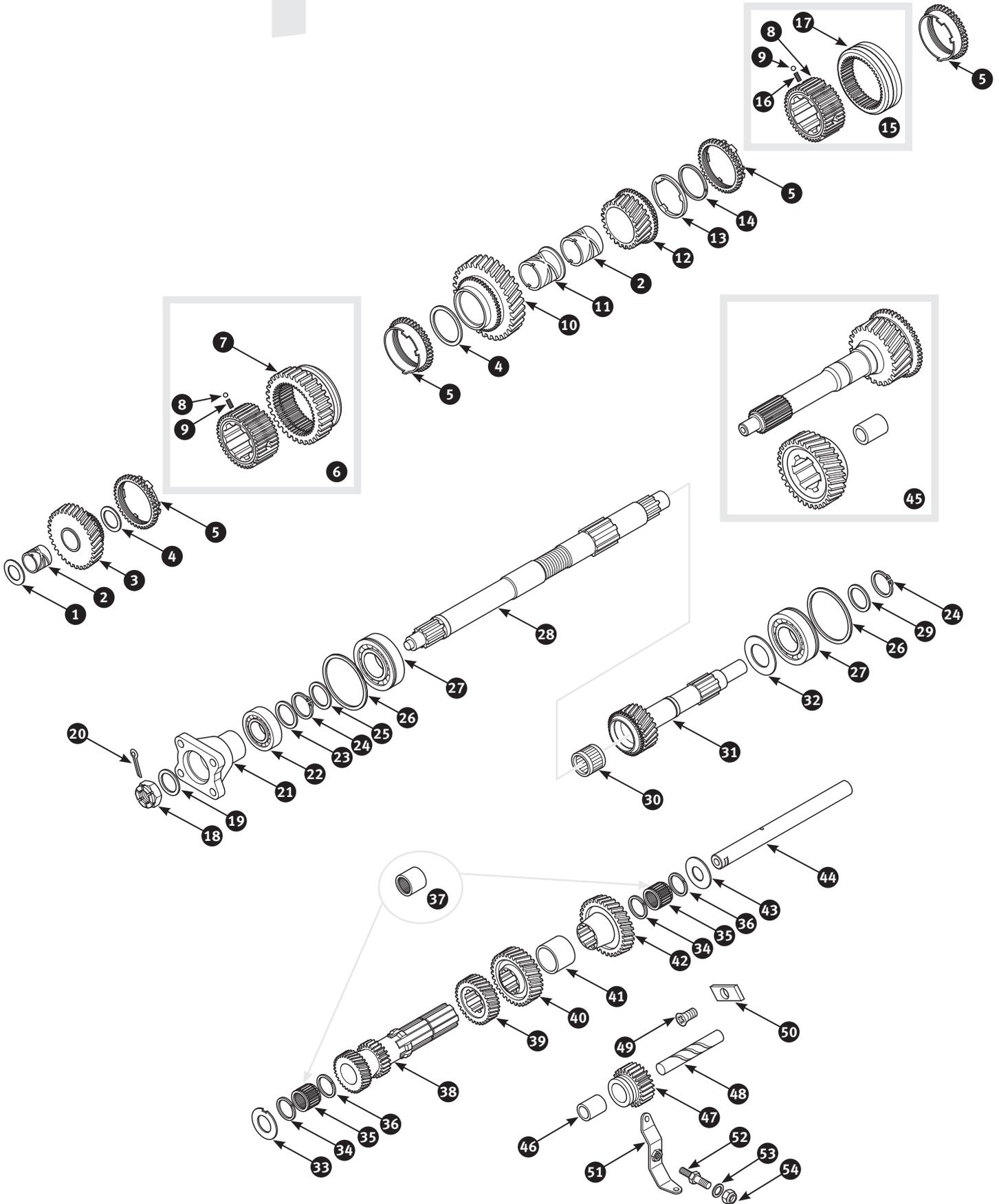

No	Part No	Description	Qty	Notes
30	292	Needle bearing	1	
31	18285	First motion shaft	1	
32	3440	Oil thrower	1	
33	9788	Thrust washer needle bearing rear	1	
34	9775	Circlip for open cage needle bearing	2	
35	9946	Needle bearing open cage type	2	
36	9972	Spacing washer for open cage needle bearing	2	
37	260	Needle bearing shell type - original equipment	2	} May replace open cage needle bearing with spacer and circlip (ill. 34 to 36)
37	484494	Needle bearing shelled type - reproduction	2	
38	263	Lay gear	1	
39	9716	Gear 2nd - on lay shaft	1	
40	9717	Gear 3rd - on lay shaft	1	
41	3417	Distance piece lay gear	1	
42	485051	Gear constant mesh 4th speed	1	
43	9789	Thrust washer needle bearing front	1	
44	262	Lay shaft original equipment	1	
44	214937	Lay shaft reproduction	1	
45	1816	Gear set	1	} Contains first motion shaft, constant gear with bush
46	2219	Bush reverse speed	1	
47	264	Gear reverse speed	1	
48	9681	Shaft reverse speed	1	
51	322439	Lever reverse speed	1	
52	5078	Bolt reverse speed lever	1	
53	10844	Plain washer	1	
54	2829	Nyloc nut	1	

Gear knob

wood, with ,Triumph' badge
 Part no. 15111

leather, with ,Triumph' badge
 Part no. 15113



Order free of charge:

Tuning catalogue

2.5

Gearbox and overdrive

Overdrive - ,A' type, outer

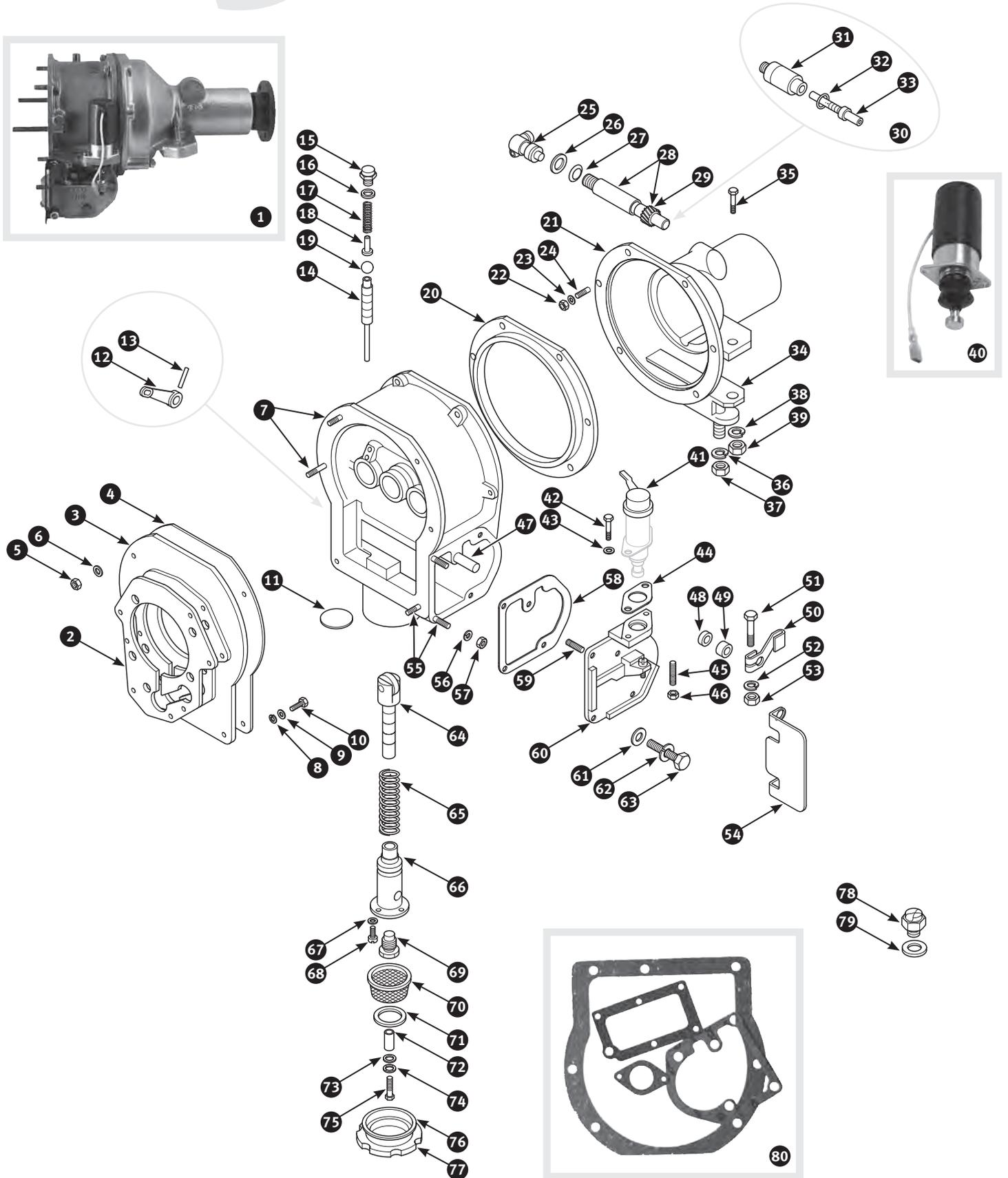

No	Part No	Description	Qty	Notes
1	327441	Overdrive exchange - serial no. 22/61275	1	} TR2 to TS5979
1	213942	Overdrive exchange - serial no. 22/61374	1	
1	327442	Overdrive exchange - serial no. 22/61712	1	} TR2 from TS5980, TR3, TR3A, TR4 to October 1964
1	327443	Overdrive exchange - serial no. 22/61753	1	
2	4753	Gasket gearbox to adaptor plate	1	} TR4 from October 1964, TR4A with solid rear axle
3	1331	Adaptor plate overdrive	1	
4	4754	Gasket overdrive to adaptor plate	1	} TR4A IRS
5	2303	Nut adaptor plate to overdrive	6	
6	212194	Spring washer	6	
7	11004	Stud - length: 2 5/8"	2	
7	11006	Stud - length: 1"	1	
7	7998	Stud - length: 1.1/4"	3	
8	212193	Plain washer	6	
9	212194	Spring washer	6	
10	212165	Screw adaptor plate to gearbox	6	
11	448734	Core plug	1	
12	300728	Adjusting lever overdrive operating shaft	1	
13	18360	Retaining pin adjusting lever	1	
14	205908	Operating valve overdrive	1	
15	11635	Blanking plug operating valve	1	
16	8977	Copper washer	1	
17	205911	Compression spring	1	
18	205912	Plunger	1	
19	6908	Steel ball	1	
20	2450	Brake ring	1	
21	327377	Rear casing overdrive	1	
22	2303	Nut	6	
23	212194	Spring washer	6	
24	7293	Stud - length: 1.5/8"	4	
24	15372	Stud - length: 3"	2	
25	5257	Angle drive speedometer cable	1	} TR4A only
26	5465	Copper washer	1	
27	19748	Oil seal speedo pinion	1	} Original type
28	288869	Speedometer pinion with bearing assembly	1	
29	316622	Pinion separately	1	} May replace original speedometer pinion (ill. 28 to 29)
30	305005	Speedometer pinion assembly	1	
31	10344	Bearing separately	1	
32	327553	,O' ring separately	1	
33	4762	Pinion separately	1	
34	201009	Gearbox mounting rubber	1	
35	3776	Screw overdrive to mounting	2	
36	7461	Spring washer	2	
37	3809	Nut	2	
38	2215	Spring washer	2	
39	2869	Nut mounting to chassis	2	
40	20431	Solenoid Overdrive	1	
41	327406	Cover solenoid	1	
42	201980	Screw solenoid retaining	2	
43	212189	Plain washer	2	
44	16033	Gasket solenoid	1	
45	25355	Adjusting screw solenoid stop	1	
46	448855	Nut	1	
47	9872	Shaft solenoid to operating valve	1	
48	2062	,O' ring operating valve shaft	1	
49	16256	Spacer operating valve shaft	1	

No	Part No	Description	Qty	Notes
50	9868	Lever	1	
51	11407	Bolt	1	
52	212191	Plain washer	1	
53	7656	Nut	1	
54	299092	Stoneguard solenoid	1	
55	19618	Stud side cover to overdrive casing.	2	
56	212194	Spring washer	2	
57	2303	Nut	2	
58	4958	Gasket side cover to overdrive casing	1	
59	9653	Dowel side cover.	1	
60	3353	Side cover overdrive	1	
61	212193	Plain washer	2	
62	212194	Spring washer	2	
63	7893	Screw side cover to overdrive casing.	2	
64	205914	Plunger oil pump.	1	
65	5544	Spring for oil pump plunger.	1	
66	10576	Housing oil pump	1	
67	212190	Spring washer	2	
68	201980	Screw	2	
69	19713	Screw plug oil pump	1	
70	4909	Oil strainer	1	
71	201498	Magnet rings oil strainer	1	Supplied in sets of 3
72	300722	Distance collar	1	
73	7793	Plain washer	1	For overdrive units 22/61275, 22/61374 and 22/61712 only
74	212190	Spring washer	1	
75	300629	Bolt	1	
76	2444	Fibre washer	1	
77	205923	Screw plug oil drain.	1	
78	26256	Switch overdrive isolation.	2	On remote control housing
79	2449	Fibre washer on switch.	2	
80	316561	Gasket kit overdrive.	1	



Spanner
for oil filter plug on ,A' type overdrive
Part no. 19182



Drain plug key
The wrench has nine various sizes which will fit most cars. An excellent tool for the removal of female drain plugs from axles and engine sumps.
Part no. 311658

2.6

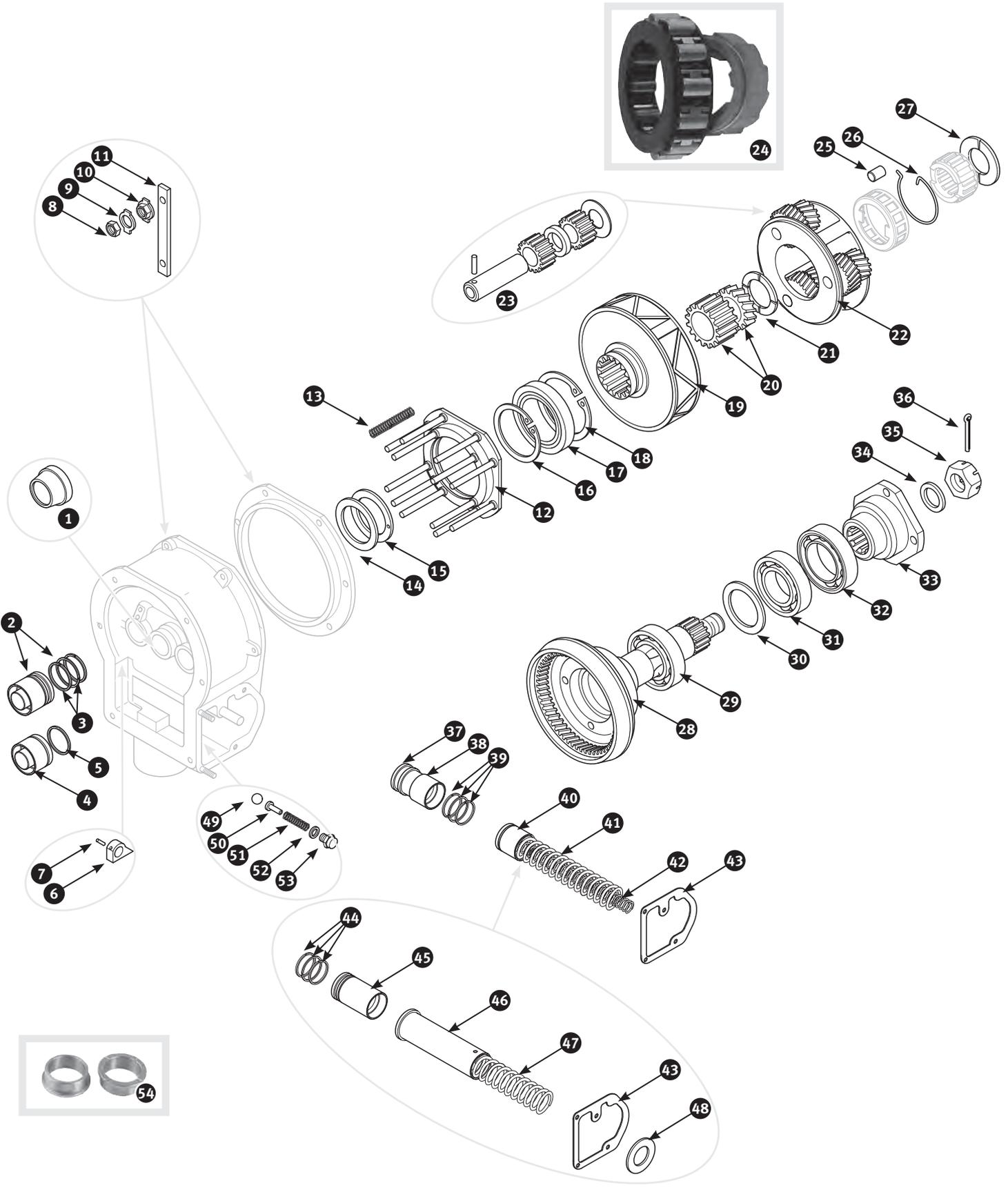



No	Part No	Description	Qty	Notes
1	202468	Drive dog oil pump	1	
2	300718	Operating piston with piston rings - diameter 1 1/8"	2	For overdrive 22/61275
3	316131	Piston ring set operating piston - diameter 1 1/8"	2	
4	10393	Operating piston with o-rings - diameter 1 3/8"	2	For overdrive 22/61374, 22/61712 and 22/61753
5	5563	,O' ring operating piston - diameter 1 3/8"	2	
6	299027	Cam overdrive operating shaft	1	
7	299028	Retaining pin for cam.	1	
8	2828	Nut bridge bar.	4	
9	205903	Lock tab bridge bar	4	
10	293225	Nut with lock tab - bridge bar.	4	May replace original nut and lock tab (ill. 8 and 9)
11	20113	Bridge bar	2	
12	19701	Thrust ring with pins assembly	1	
13	336719	Spring thrust ring - supplied in sets of 8	1	
14	1661	Shim sun wheel - 0,113" to 0,114"	0	Quantity as required
14	10055	Shim sun wheel - 0,107" to 0,108"	0	
14	1674	Shim sun wheel - 0,101" to 0,102"	0	
14	1720	Shim sun wheel - 0,095" to 0,096"	0	
14	3523	Shim sun wheel - 0,089" to 0,090"	0	
14	10056	Shim sun wheel - 0,083" to 0,084"	0	
14	203448	Shim sun wheel - 0,077" to 0,078"	0	
15	205877	Thrust washer bronze - at front of sun wheel	1	
16	10423	Circlip small - ball bearing thrust ring	1	
17	205860	Ball bearing on overdrive thrust ring	1	
18	205862	Circlip large - ball bearing to thrust ring.	1	
19	205859	Clutch overdrive - exchange	1	
19	17854	Clutch sliding member - exchange, competition type.	1	
20	293534	Sun wheel	1	
21	205876	Thrust washer bronze - sun wheel rear	1	
22	290517	Planet carrier assembly	1	
23	16845	Needle bearing planet gears.	3	
24	205885	Uni directional clutch including roller set	1	
25	205886	Roller bearing unidirectional clutch - supplied in sets of 12	1	
26	5561	Spring uni directional clutch.	1	
27	205888	Thrust washer bronze - uni directional clutch	1	
28	336688	Annulus assembly	1	
28	298963	Annulus - outer ring separately	1	
29	211865	Ball bearing annulus front	1	
30	15370	Shim annulus - 0,146"	0	Quantity as required
30	298962	Shim annulus - 0,151"	0	
30	15366	Shim annulus - 0,156"	0	
30	295687	Shim annulus - 0,161"	0	
30	19227	Shim annulus - 0,166"	0	
31	3935	Ball bearing annulus rear	1	
32	1032	Oil seal overdrive rear	1	
33	12065	Flange gearbox end - angular type	1	
33	300841	Flange gearbox end - round type	1	
34	10974	Plain washer	1	
35	3351	Slotted nut	1	
36	7466	Split pin	1	
37	205927	,O' ring accumulator housing	1	For overdrive 22/61275, 22/61374 and 22/61712
38	202055	Housing accumulator	1	
39	300708	Piston ring set accumulator piston	1	
40	300717	Accumulator piston less piston rings	1	
41	21360	Spring accumulator outer	1	
42	300720	Spring accumulator inner	1	

2.6

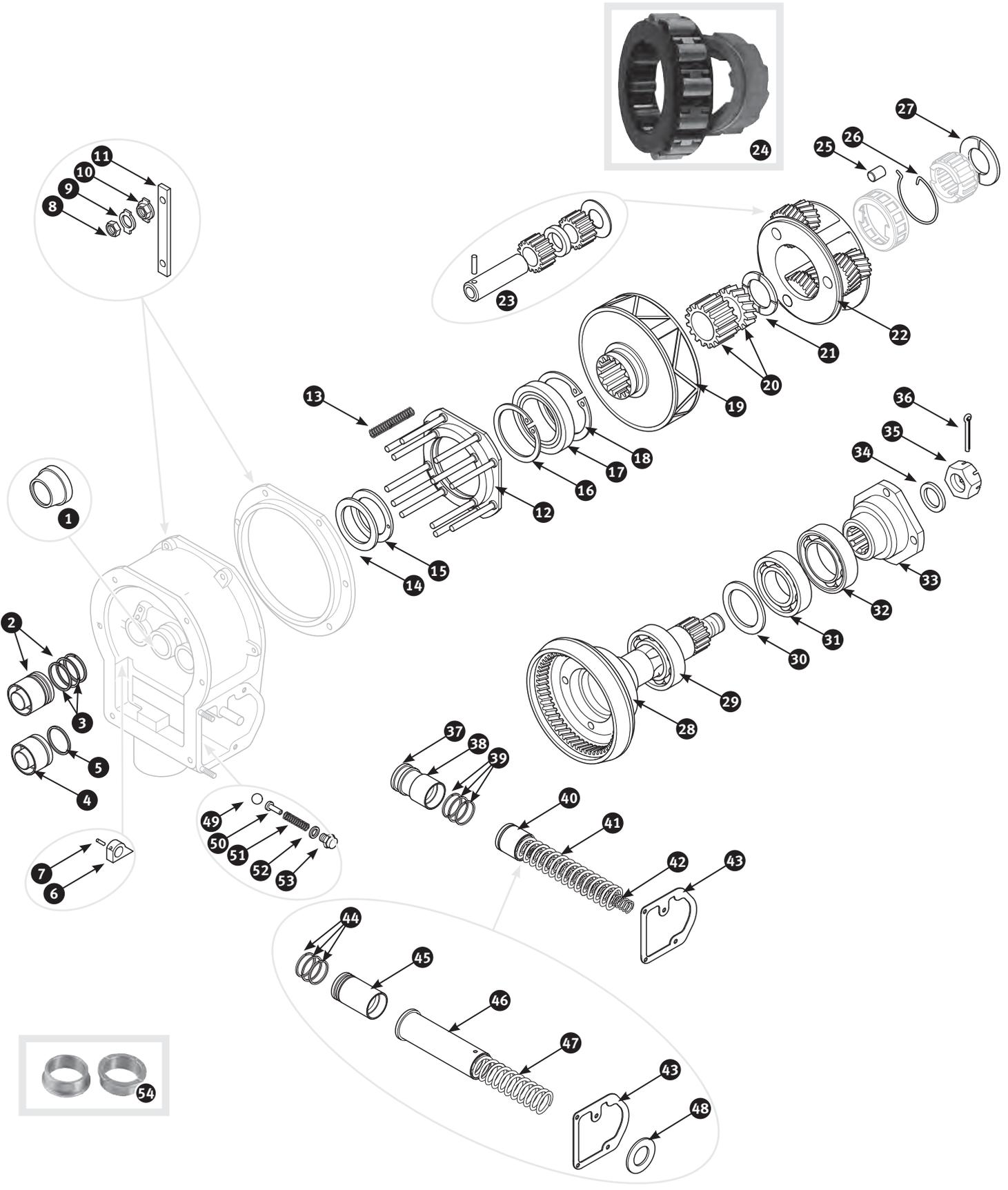

No	Part No	Description	Qty	Notes
43	4958	Gasket side cover to overdrive casing	1	
44	2970	Piston ring set accumulator piston - set of 6	1	For Overdrive 22/61753
45	2969	Accumulator piston with piston rings.	1	
45	17855	Accumulator piston competition type with two uprated springs and a larger piston	1	
46	205931	Distance tube accumulator piston	1	
47	205930	Spring accumulator piston	1	
47	355745	Spring accumulator piston, uprated type. Supplied in pairs	1	
48	215457	Shim spring pressure on accumulator piston	1	
49	6906	Steel ball pump valve	1	
50	205912	Plunger pump valve.	1	
51	205911	Compression spring pump valve	1	
52	8977	Copper washer pump valve	1	
53	11635	Blanking plug pump valve	1	
54	326040	Bronze bushes for gearbox mainshaft in overdrive body. Supplied in pairs.	1	

Multi purpose oil LOS40
 eliminate scuff marks from tile floors, remove water spots and mildew on mirrors and windows, clean dirt marks and crayon from walls and floors, lubricate sticky cabinets and drawers, stop squeaks on door hinges and furniture. 400 ml aerosol
 Part no. 294716



Oil drain pan
 16l volume, height: 14 cm, integrated funnel, large handles, acid resistant, antispash-system, very practical for a convenient and clean oil change
 Part no. 293584

3.1

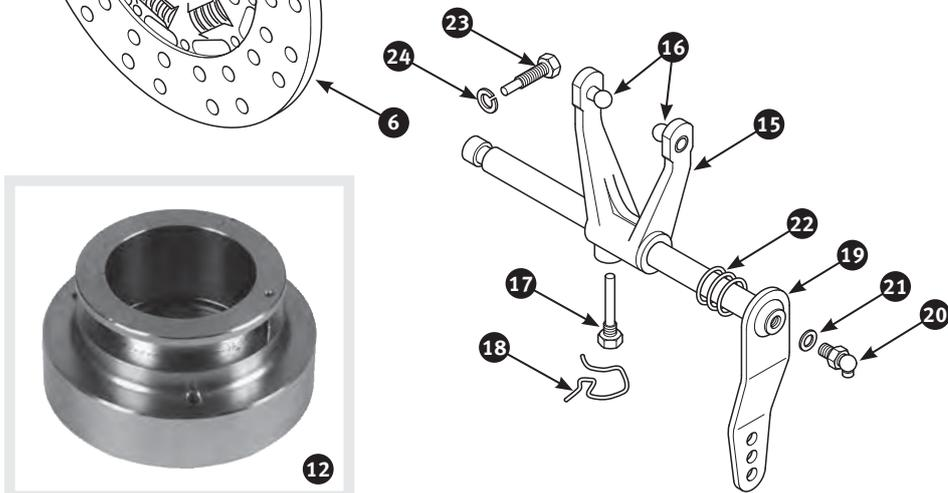
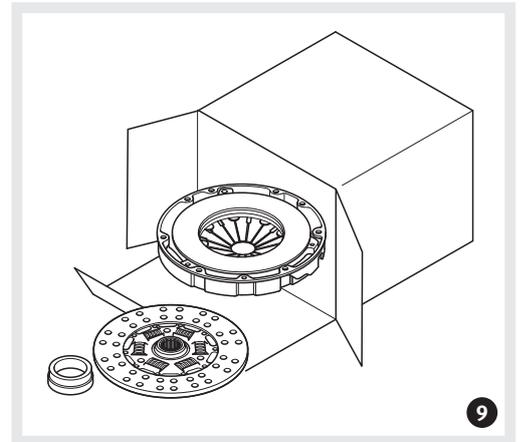
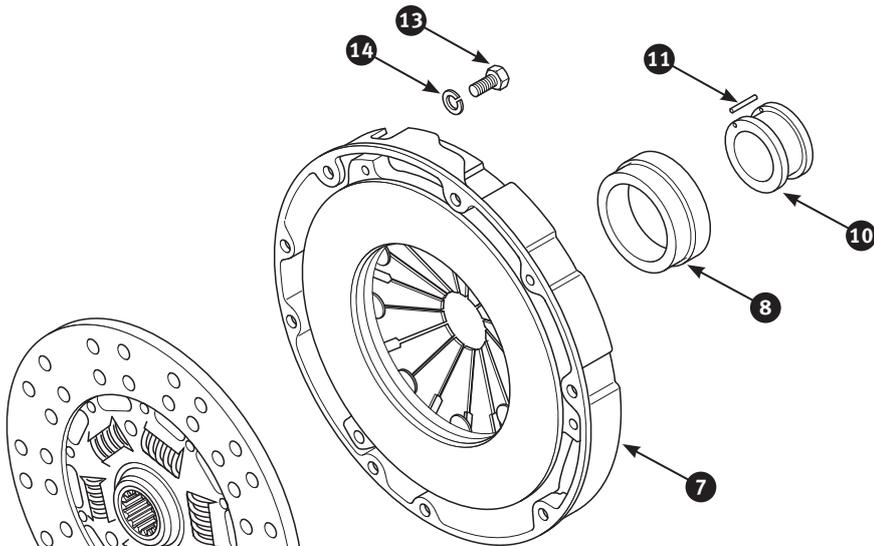
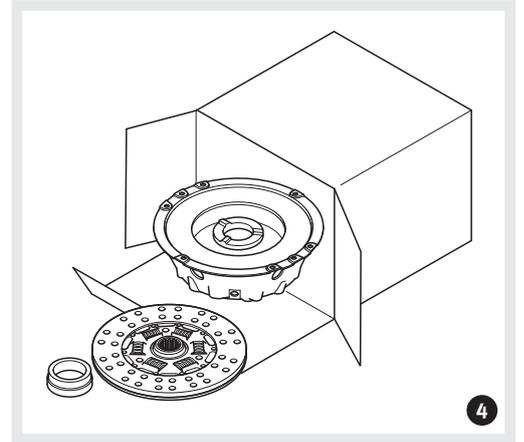
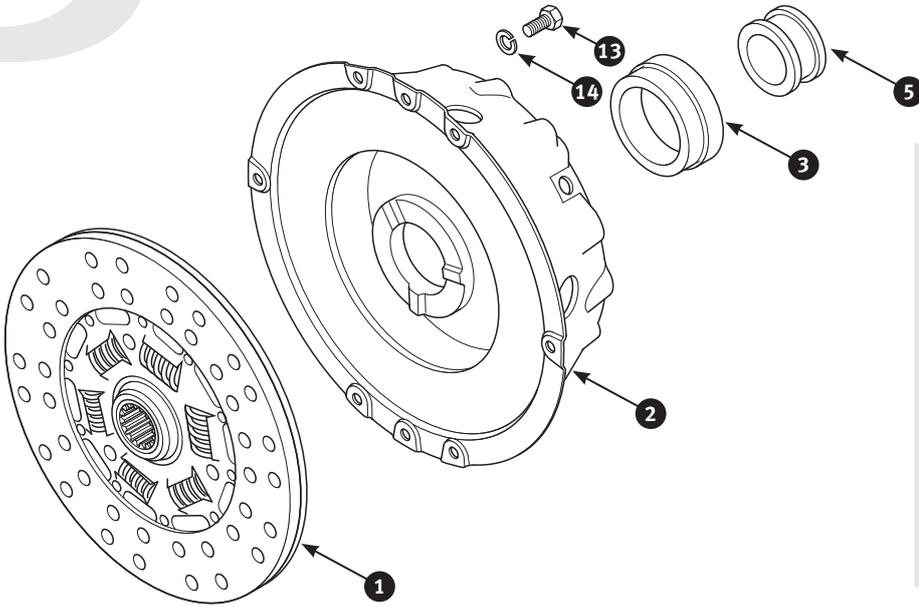

No	Part No	Description	Qty	Notes
1	2376	Clutch plate - identify by 10 splines.	1	TR2 to TR4
2	2772	Clutch cover	1	
3	363	Clutch release bearing	1	
4	15017	Clutch kit	1	
5	215122	Sleeve release bearing carrier	1	
6	3058	Clutch plate - identify by 23 splines	1	TR4A
7	19025	Clutch cover	1	
8	1045	Clutch release bearing	1	
9	15018	Borg & Beck Clutch kit	1	
10	3357	Sleeve release bearing carrier	1	
11	14676	Roll pin release fork to carrier.	1	
12	328991	Clutch release bearing reinforced roller type, complete with sleeve. 1		
13	7877	Screw clutch cover to flywheel	6	
14	212194	Spring washer	6	
15	201053	Release fork clutch	1	
16	201045	Pin release bearing to clutch fork	2	TR2 to TR4
17	25154	Locating peg release fork	1	
18	4869	Lock wire locating peg	1	
19	2773	Shaft clutch release fork, greaseable type	1	TR4A
20	3345	Grease nipple clutch shaft	2	
21	11441	Fibre washer	2	TR4A
19	9693	Shaft clutch release fork, non greaseable type	1	
22	21381	Spring	1	Cut to length after fitting
23	6501	Bolt shaft to gearbox casing.	1	
24	212194	Spring washer	1	TR2 to TR4
25	16275	Alignment tool for clutch, 10 splines	1	
25	25700	Alignment tool for clutch, 23 splines	1	



Clutch aligning tool

„Clutch Mate“. Fits 99% of vehicles up to 5 tons except Minis and vehicles with double plate clutches

Part no. 321619

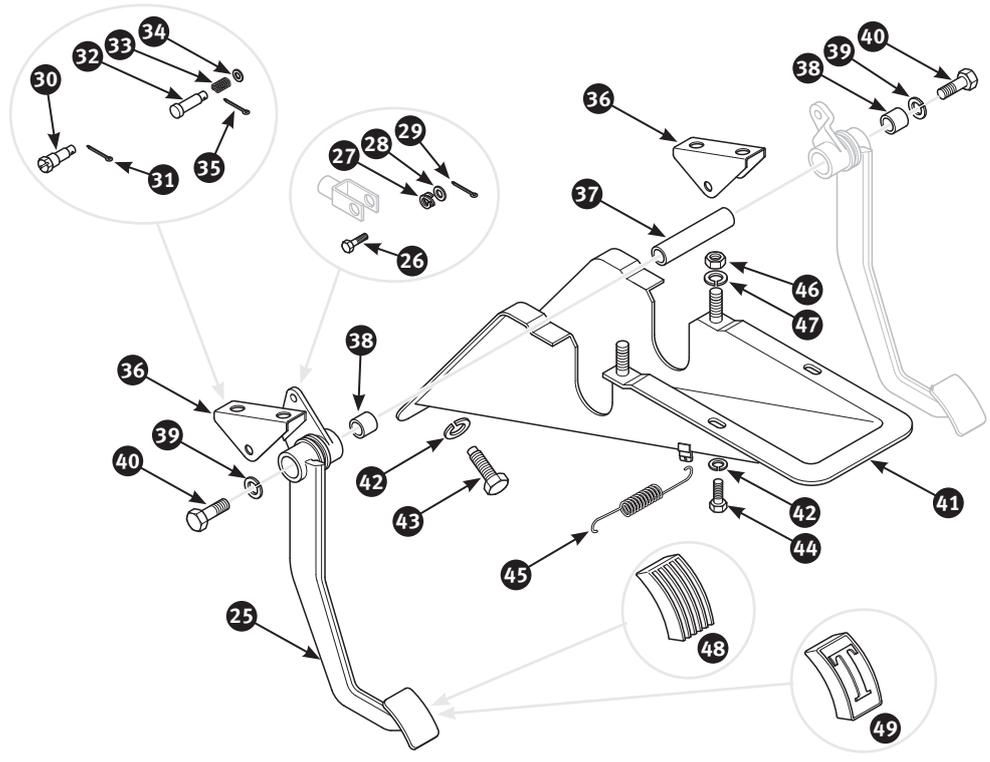
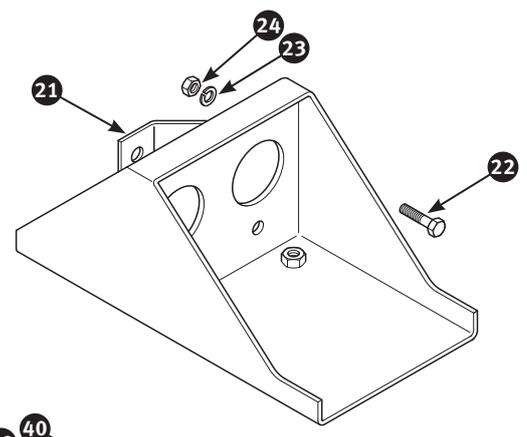
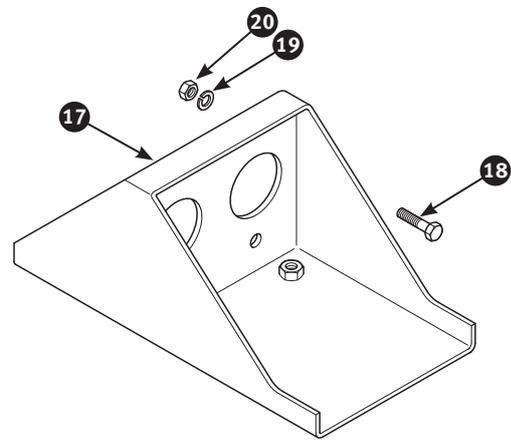
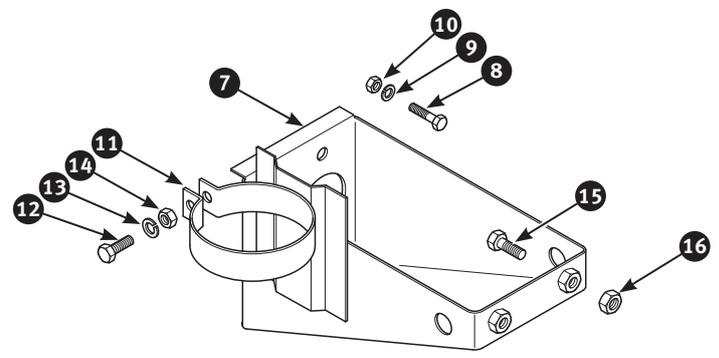
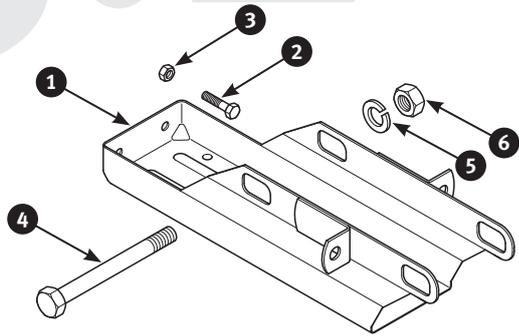

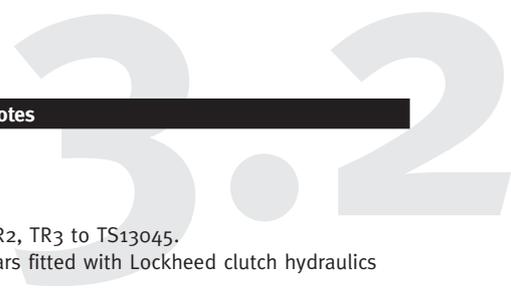

No	Part No	Description	Qty	Notes
1	468204	Bracket clutch and brake master cylinder	1	TR2, TR3 to TS13045. Cars fitted with Lockheed clutch hydraulics
2	7886	Screw pedal stop	2	
3	7656	Nut	2	
4	26515	Bolt master cylinder to bracket	2	
5	212194	Spring washer	2	
6	2303	Nut	2	
7	300697	Bracket clutch and brake master cylinder	1	TR3 from TS13046 to TR3A. Cars fitted with Girling clutch hydraulics
8	7894	Screw clutch master cylinder to bracket	2	
9	212194	Spring washer	2	
10	2303	Nut	2	
11	300657	Fixing strap supply tank	1	
12	1912	Screw supply tank to bracket	1	
13	212192	Spring washer	1	TR4 to CT26929. Identify by hydraulic brake light switch
14	2828	Nut	1	
15	7886	Screw pedal stop	2	
16	7656	Nut	2	
17	324643	Bracket clutch and brake master cylinder	1	
18	7894	Screw clutch master cylinder to bracket	2	
19	212194	Spring washer	2	TR4 from CT26930, TR4A. Identify by mechanical brake light switch
20	2303	Nut	2	
21	300686	Bracket clutch and brake master cylinder	1	
22	7894	Screw clutch master cylinder to bracket	2	
23	212192	Spring washer	2	
24	2303	Nut	2	
25	300639	Clutch pedal IHD	1	TR2, TR3 to TS13045. Cars fitted with Lockheed clutch hydraulics
25	300635	Clutch pedal RHD	1	
25	289141	Clutch pedal LHD	1	TR3 from TS13046 to TR3A. Cars fitted with Girling clutch hydraulics
25	289141	Clutch pedal RHD	1	
25	366596	Clutch pedal LHD	1	TR4 and TR4A
25	300677	Clutch pedal RHD	1	
26	14064	Clevis pin fork to clutch pedal	1	TR2, TR3 to TS13045. Cars fitted with Lockheed clutch hydraulics
27	6307	Double coil washer	1	
28	212193	Plain washer	1	
29	10846	Split pin	1	
30	3349	Tapper screw fork to clutch pedal	1	
31	3269	Split pin	1	
32	14064	Clevis pin fork to clutch pedal	1	TR3 from TS13046 to TR3A. Cars fitted with Girling clutch hydraulics
33	294502	Spring	1	
34	212193	Plain washer	1	
35	7465	Split pin	1	
36	300637	Bracket pedal shaft	4	
37	2361	Pedal shaft	1	
38	9677	Bush pedal shaft	4	TR4 and TR4A
39	2051	Spring washer	2	
40	7898	Screw	2	
41	300634	Cover pedal shaft	1	
42	212194	Spring washer	4	
43	212162	Screw cover to bulkhead	2	
44	7893	Screw cover to bulkhead	2	TR2, TR3 to TS13045 TR3 from TS13046 to TR3A to TR4A
45	3401	Return spring clutch pedal	1	
46	2303	Nut	4	
47	212194	Spring washer	4	
48	226	Pedal rubber ribbed	1	
49	201064	Pedal rubber with ,T' logo	1	



No	Part No	Description	Qty	Notes
1	299758	Brake and clutch master cylinder original type	1	
1	11268	Brake and clutch master cylinder replacement	1	
2	3540	Seal kit clutch and brake master cylinder.	1	
3	300710	Cover	1	Use on original master cylinder
4	21422	Gasket	1	
5	5645	Screw	4	
6	209089	Shakeproof washer	4	
7	21765	Gasket for metal filler cap	1	
8	8536	Filler cap - metal	1	
9	4992	Filler cap - plastic	1	
10	6311	Spring	2	
11	5644	Gasket	1	
12	300711	Plate	1	
13	5645	Screw	2	
14	209089	Shakeproof washer	2	
15	459342	Retaining clip on gaiter - large	1	
16	13071	Gaiter push rod	2	
17	459343	Retaining clip on gaiter - small	1	
18	295688	Push rod original type	1	May replace original push rod 295688 - cut to required length
18	13742	Push rod replacement	1	
19	14064	Clevis pin fork to pedal	1	
20	6307	Double coil washer	1	
21	212193	Plain washer	1	
22	10846	Split pin	1	
23	300642	Locator bracket master cylinder	1	
24	7656	Nut locator bracket	2	
25	26515	Bolt	2	
26	212195	Plain washer	4	
27	2051	Spring washer	2	
28	3073	Nut	2	
29	293765	Adaptor clutch pipe	1	Use on original master cylinder
29	8749	Adaptor clutch pipe	1	Use on replacement master cylinder
30	12064	Copper washer	1	
31	15340	Pipe to clutch hose	1	LHD
31	21388	Clutch pipe to clutch hose	1	RHD
32	13703	Clutch hose	1	
33	13278	Clutch hose aeroquip type	1	
34	5356	Locking nut clutch hose	1	
35	300330	Shakeproof washer clutch hose to chassis bracket	1	
36	5465	Copper washer	1	
37	297972	Clutch slave cylinder original style.	1	
no ill.	17696	Seal for original clutch slave cylinder.	1	
38	1115	Clutch slave cylinder less push rod	1	May replace original slave cylinder 297972 (ill. 37)

No	Part No	Description	Qty	Notes
39	2446	Bleed screw clutch slave cylinder	1	
40	297974	Push rod original style	1	
40	13742	Push rod replacement	1	} May replace original push rod 297974
41	7739	Nut	1	
42	3348	Fork push rod	1	
43	3349	Tapper screw	1	
44	3269	Split pin	1	
45	10408	Anchor plate return spring	1	
46	3309	Return spring clutch slave cylinder	1	
47	301774	Bracket clutch slave cylinder.	1	
48	21358	Steady rod clutch slave cylinder	1	
49	2303	Nut	1	
50	7455	Nyloc nut	1	
51	7895	Screw	1	
52	212194	Spring washer	1	
53	2303	Nut	1	
54	319559	AP Lockheed Brake fluid DOT4 - 0.5 litre bottle	1	} Ask for our special catalogue.
54	319587	AP Lockheed Brake fluid DOT4 - 1 litre bottle.	1	

Brake bleeding set

the one man tool. Using a one way valve, the fluid is allowed through the valve but the air is prevented from returning back into the system
Part no.25750



Combination spanner set

Forged from chrome vanadium steel.

- 204790 **6 pieces**
3/8", 7/16", 1/2", 9/16", 5/8, 3/4"
- 311507 **11 pieces**
1/4", 5/16", 3/8", 7/16", 1/2", 9/16", 5/8",
11/16", 3/4", 13/16" 7/8"
- 214943 **14 pieces**
3/8", 7/16", 1/2", 9/16", 5/8", 11/16", 3/4",
13/16", 7/8", 15/16", 1", 1.1/16", 1.1/8" 1.1/4"

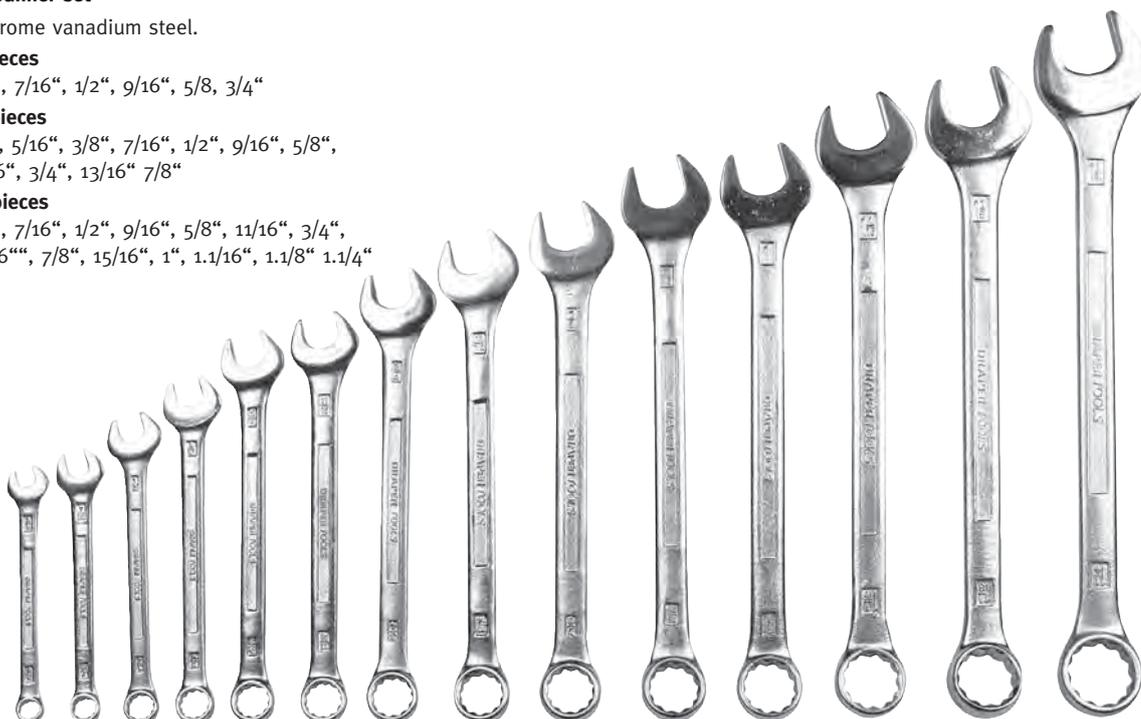

3.4

Clutch

Clutch hydraulics - TR3 from TS13046, TR3A

Girling type

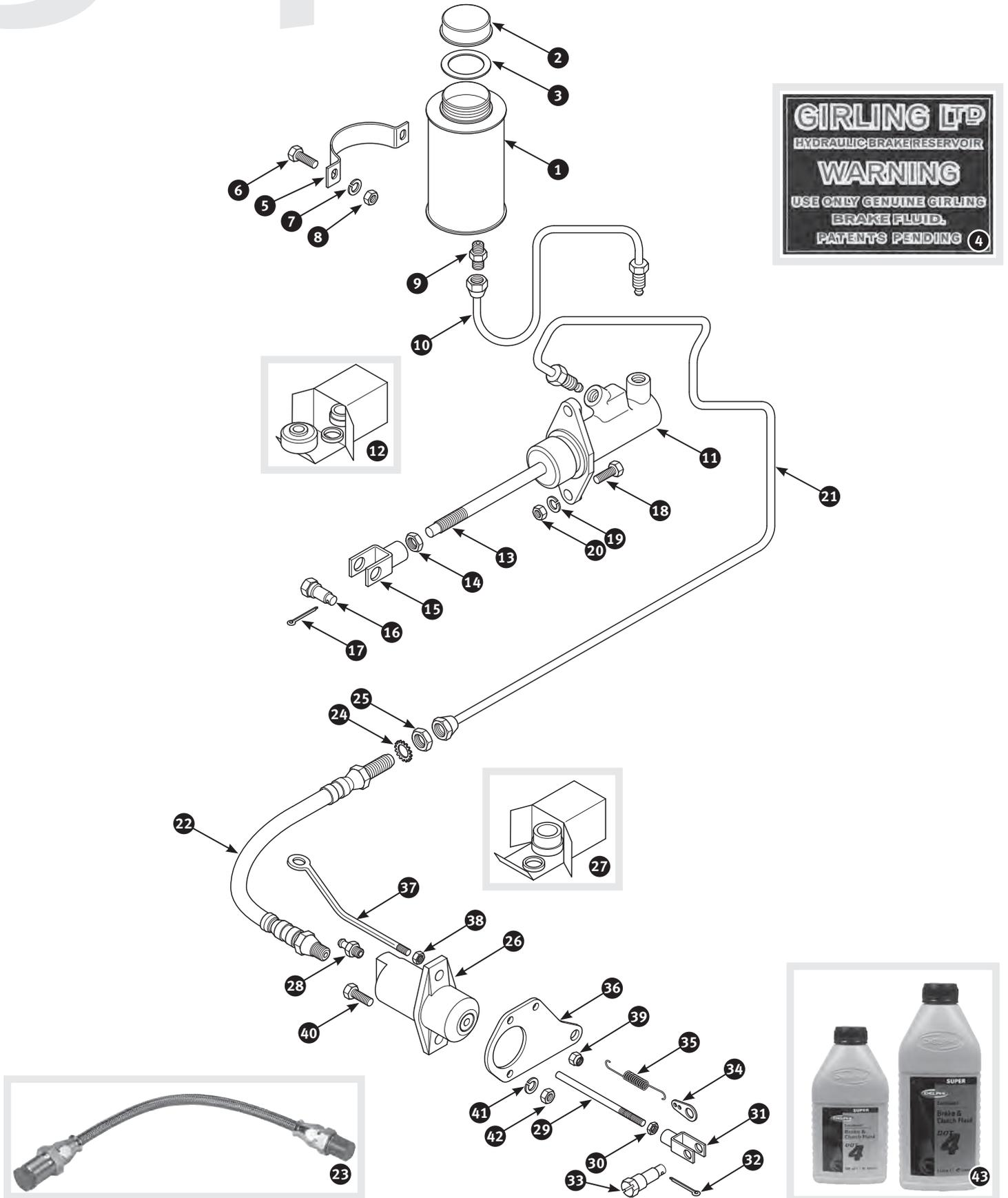

3.4

No	Part No	Description	Qty	Notes
1	3516	Supply tank dual supply.	1	
2	17931	Filler cap	1	
3	21320	Sealing ring	1	
4	14561	Sticker ,Girling' - for supply tank.	1	
5	300657	Fixing strap supply tank.	1	
6	1912	Screw	2	
7	212192	Spring washer	2	
8	2828	Nut	2	
9	327331	Adaptor supply tank to pipe.	2	
10	11637	Pipe supply tank to master cylinder	1	
11	1455	Brake and clutch master cylinder	1	Less pushrod
12	14463	Seal kit clutch master cylinder	1	
13	15333	Push rod clutch master cylinder	1	
14	7739	Nut	1	
15	3348	Fork push rod	1	
16	3349	Tapper screw fork to clutch pedal	1	
17	3269	Split pin	1	
18	7894	Screw	2	
19	212194	Spring washer	2	
20	2303	Nut	1	
21	21424	Clutch pipe to hose	1	LHD
21	21423	Clutch pipe to hose	1	RHD
22	14081	Hydraulic hose to clutch slave cylinder	1	
23	14409	Clutch hose to clutch slave cylinder.	1	Aeroquip type
24	209117	Shakeproof washer	1	
25	7741	Nut	1	
26	14250	Clutch slave cylinder	1	
27	370	Seal kit clutch slave cylinder.	1	
28	202323	Bleed screw	1	
29	13742	Push rod clutch slave cylinder.	1	Replacement with 5/16" UNF thread
30	7739	Nut	1	
31	3348	Fork push rod	1	
32	3349	Tapper screw fork to clutch operating shaft lever	1	
33	3269	Split pin	1	
34	10408	Anchor plate return spring	1	
35	3309	Return spring clutch slave cylinder	1	
36	300668	Bracket clutch slave cylinder.	1	
37	21358	Steady rod clutch slave cylinder	1	
38	2303	Nut	1	
39	7455	Nyloc nut	1	
40	7895	Screw	1	
41	212194	Spring washer	1	
42	2303	Nut	1	
43	319559	AP Lockheed Brake fluid DOT4 - 0.5 litre bottle	1	Ask for our special catalogue.
43	319587	AP Lockheed Brake fluid DOT4 - 1 litre bottle	1	

No	Part No	Description	Qty	Notes
1	1302	Clutch master cylinder identify by 0.75" bore size.	1	
2	14463	Seal kit clutch master cylinder - identify by 0.75" bore size.	1	Please note: the bore size is cast onto the outside of the cylinder
2	14796	Seal kit clutch master cylinder - identify by 0.7" bore size.	1	
3	17931	Filler cap	1	
4	21320	Sealing ring filler cap.	1	
5	14064	Clevis pin fork to pedal	1	
6	294502	Spring	1	
6	6307	Double coil washer	1	May replace spring 294502 (ill. 6)
7	212193	Plain washer	1	
8	7465	Split pin	1	
9	2826	Screw clutch master cylinder to bracket.	2	
10	212194	Spring washer	2	
11	3073	Nut	2	
12	21409	Clutch pipe to hose - LHD models.	1	TR4
12	21421	Clutch pipe to hose - RHD models.	1	
13	14081	Hydraulic hose to clutch slave cylinder	1	
14	14409	Clutch hose to clutch slave cylinder - aeroquip type	1	
15	209117	Shakeproof washer	1	
16	7741	Nut	1	
17	11381	Banjo bolt for banjo connector	1	
18	19457	Copper washer	1	
19	6562	Banjo connector pipe to clutch master cylinder.	1	TR4A - RHD models
20	12064	Copper washer	1	
21	315991	Clutch pipe to union	1	
22	9763	Adaptor pipe to clutch master cylinder	1	
23	12064	Copper washer	1	TR4A - LHD models
24	9929	Clutch pipe to union	1	
25	10438	Inline connector clutch pipe	1	
26	11824	Clutch hose plastic type	1	TR4A
27	14292	Clutch hose aeroquip type	1	
28	9763	Adaptor hose to clutch slave cylinder	1	
29	14250	Clutch slave cylinder	1	
30	370	Seal kit clutch slave cylinder - 1".	1	
31	202323	Bleed screw clutch slave cylinder	1	
32	13742	Push rod clutch slave cylinder.	1	
33	7739	Nut	1	
34	3348	Fork push rod	1	
35	3349	Tapper screw fork to clutch operating shaft lever	1	
36	3269	Split pin	1	
37	10408	Anchor plate return spring	1	TR4 with spring type clutch
38	3309	Return spring clutch slave cylinder	1	
39	300668	Bracket clutch slave cylinder.	1	
40	21358	Steady rod clutch slave cylinder	1	
41	2303	Nut	1	
42	212195	Plain washer	1	
43	2049	Nyloc nut	1	
44	7895	Screw clutch slave cylinder to bracket	1	
45	212194	Spring washer	1	
46	2303	Nut	1	
47	8694	Retaining clip clutch pipe to bulkhead.	1	TR4 - LHD models
48	3818	Self tapping screw	1	
49	290513	Retaining clip pipe.	1	TR4A
50	20031	Self tapping screw	1	

4.1

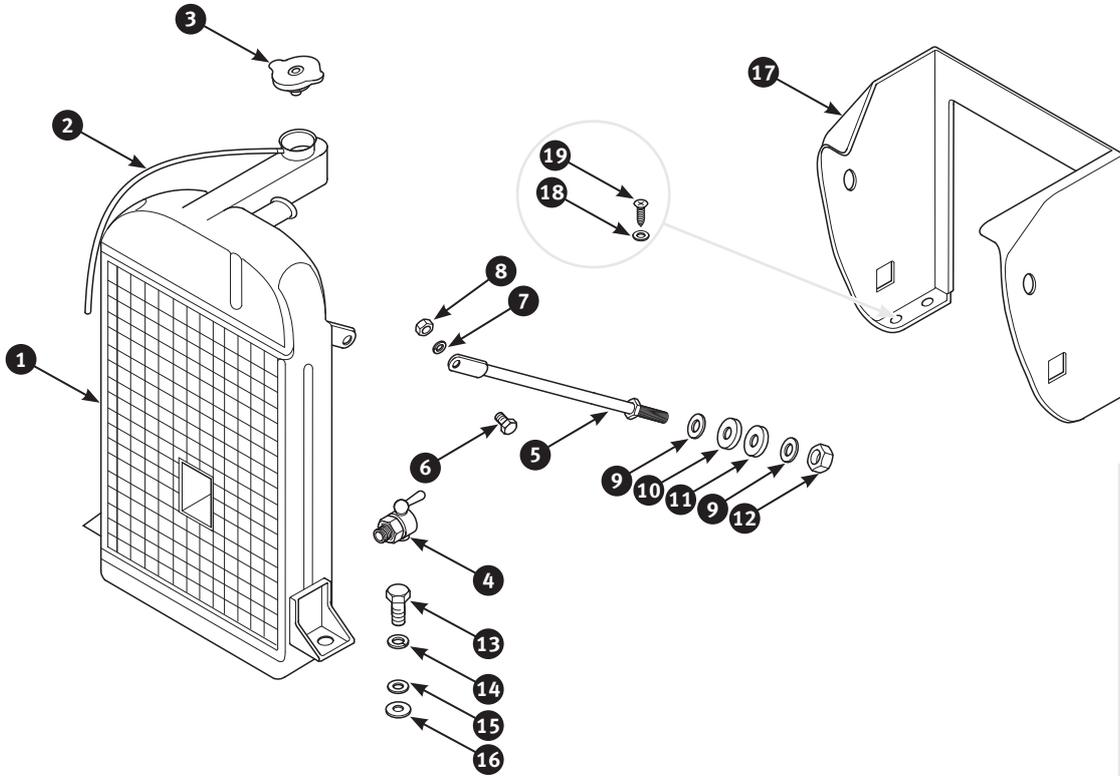

21

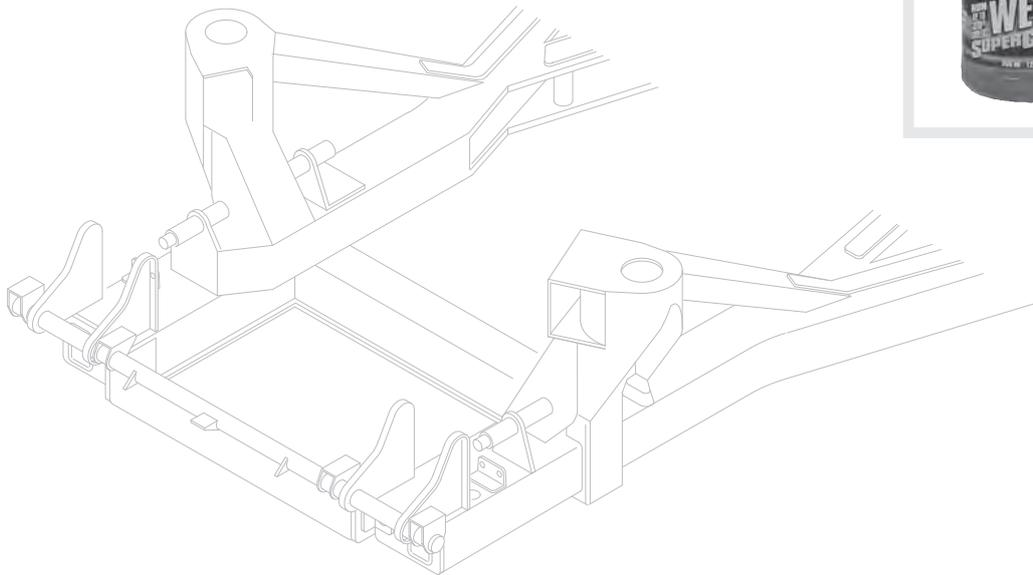

20

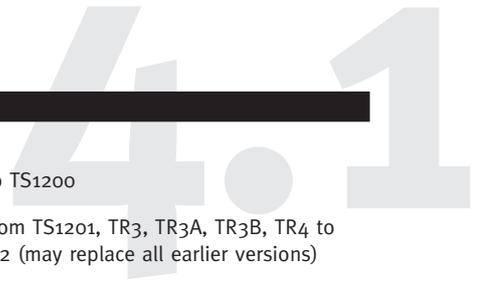

No	Part No	Description	Qty	Notes
1	316548	Radiator exchange - characteristic: centered inlet, long filler neck extension and crank hole	1	} TR2 to TS1200
1	2439	Radiator new - characteristic: offset inlet, long filler neck extension and crank hole	1	
1	301702	Radiator new - characteristic: offset inlet, no filler neck extension and without crank hole	1	} TR2 from TS1201, TR3, TR3A, TR3B, TR4 to CT9552 (may replace all earlier versions)
2	3915	Hose overflow - supplied in meters	1	
3	2131	Filler cap radiator - 4 lbs, 1" deep	1	} TR2, TR3, TR3A and TR3B with long filler neck
3	1046	Filler cap radiator - 7 lbs, 1" deep	1	
3	468035	Filler cap radiator - 7 lbs, 3/4" deep	1	} TR4 to CT9552 with long filler neck
4	17780	Water drain tap original, brass	1	
5	20425	Stay radiator, upper fixing	2	} TR4 from CT9553
5	20426	Stay radiator, upper fixing	2	
6	7893	Screw stay to radiator	2	} TR2 to TR3B
7	212194	Spring washer	2	
8	2303	Nut	2	} TR4
9	10487	Plain washer	4	
10	995	Rubber bush stay to chassis	2	}
11	996	Rubber washer	2	
12	7739	Nut	4	}
13	213888	Screw radiator to chassis frame	2	
14	2051	Spring washer	2	}
15	3811	Plain washer	2	
16	410	Packing radiator	0	} To adjust the radiator height to exactly line up the top outlet on the thermostat housing Quantity as required
17	4282	Air duct panel	1	
18	1717	Plain washer	4	} TR3A and TR3B
19	3819	Self tapping screw	4	
20	22884	Penrite Rust-preventive for the cooling system, 1 litre bottle	1	} You will find our whole range of car chemicals in our tuning catalogue.
21	303509	Redline Water Wetter, 355 ml bottle	1	



Bars Flush
 cleans and conditions the cooling system,
 100 g
 Part no. 305787

4.2

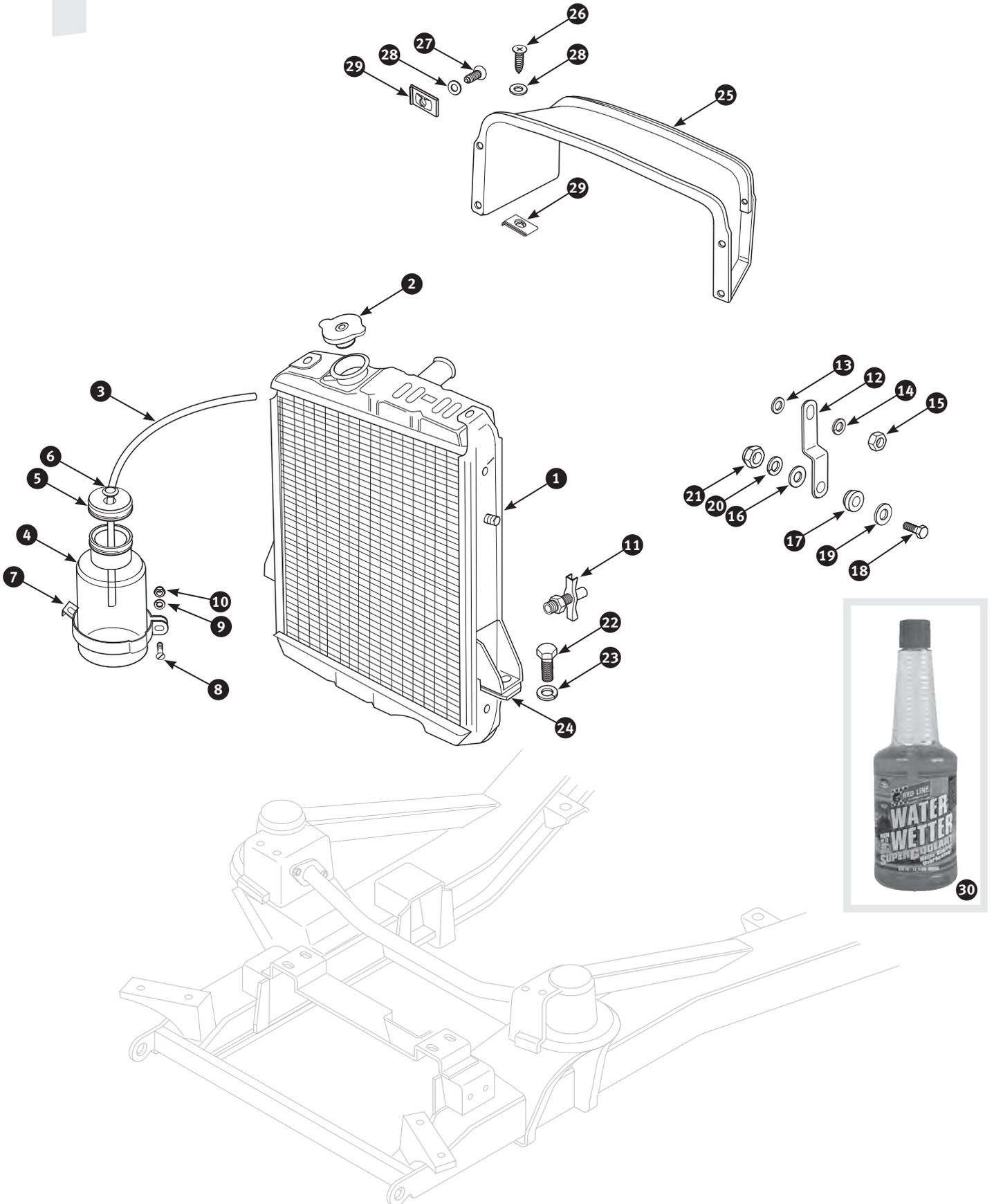

4.2

No	Part No	Description	Qty	Notes
1	2431	Radiator new item	1	
2	468035	Filler cap radiator - 7 lbs	1	
3	9697	Overflow pipe	1	
4	3529	Expansion tank	1	
5	9709	Cap expansion tank	1	
6	4533	Grommet pipe through cap	1	
7	3737	Bracket Expansion tank - genuine type	1	} Alternatives
7	1217	Bracket Expansion tank - replacement	1	
8	12789	Screw	1	
9	212190	Spring washer	1	
10	215477	Nut	1	
11	9750	Water drain tap wing type, made from brass	1	
12	299654	Bracket radiator, upper fixing	2	
13	8735	Rubber washer	2	
14	212194	Spring washer	2	
15	2303	Nut	2	
16	996	Rubber washer	2	
17	995	Rubber bush	2	
18	6521	Bolt bracket to chassis.	2	
19	10487	Plain washer	2	
20	212194	Spring washer	2	
21	2303	Nut	2	
22	213888	Screw radiator to chassis frame	2	
23	2051	Spring washer	2	
24	410	Packing radiator	0	} To adjust the radiator height to exactly line up the top outlet on the thermostat housing, Quantity as required
25	169	Air duct panel	1	
26	3822	Self tapping screw air duct to chassis - length 3/4".	3	
27	19535	Self tapping screw air duct to chassis - length: 1/2"	4	
28	7793	Plain washer	7	
29	3081	Spire nut	7	
30	303509	Redline Water Wetter 355 ml bottle.	1	} Ask for our special catalogue.



Coolant for radiator
 1.5 litre, Part no. 314878
 1 litre, Part no. 373200
 5 litres, Part no. 315178

4.3

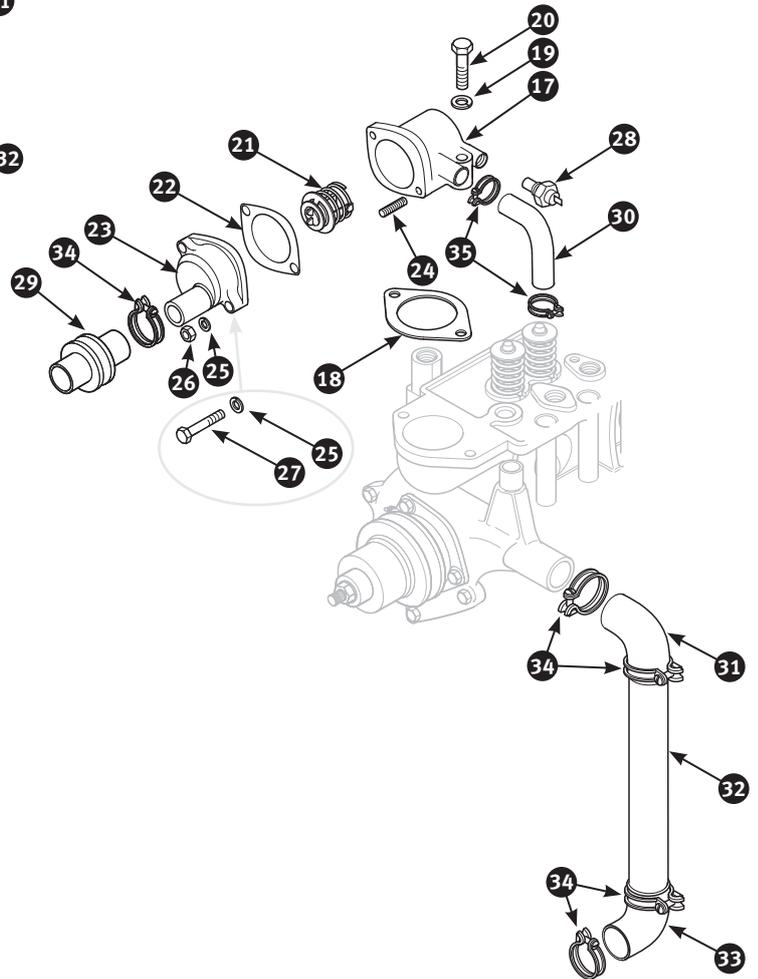
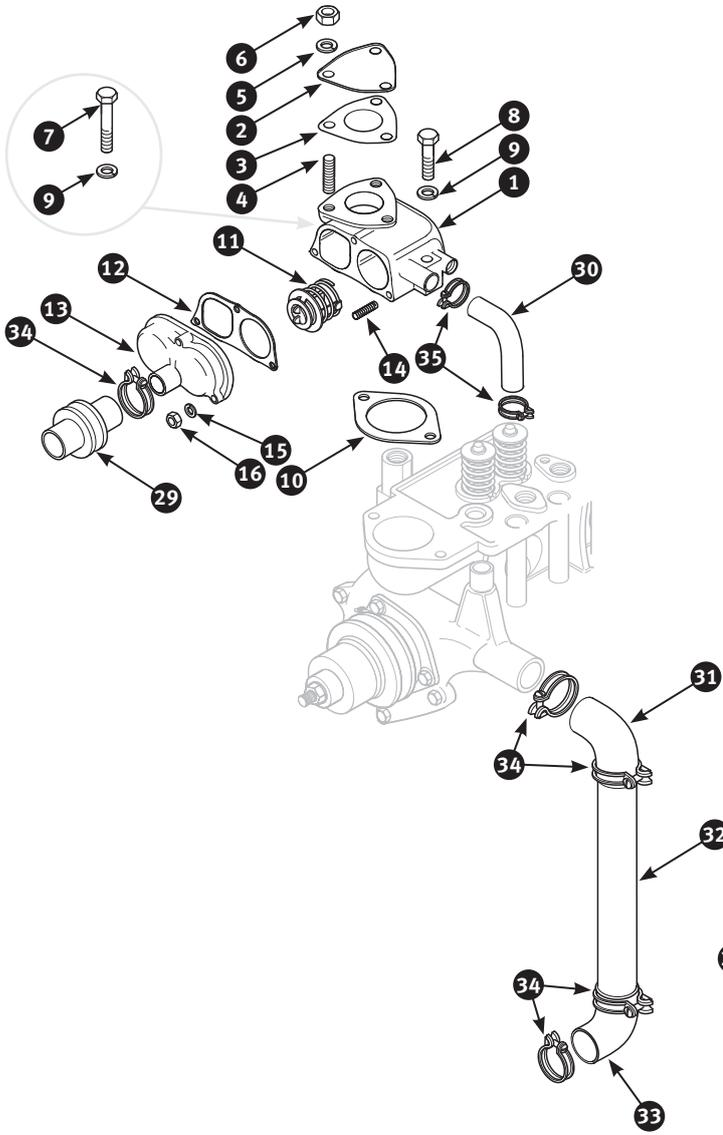

No	Part No	Description	Qty	Notes	
1	289273	Thermostat housing double chamber type	1	TR2 to TS1200	
2	289274	Cover thermostat housing.	1		
3	9738	Gasket	1		
4	207033	Stud	2		
5	212194	Spring washer	2		
6	2303	Nut thermostat housing cover.	2		
7	15412	Bolt cover and thermostat housing to cylinder head	1		
8	6501	Bolt thermostat housing to cylinder head	1		
9	212194	Spring washer	2		
10	9780	Gasket thermostat housing to cylinder head.	1		
11	1430	Thermostat 74° C	1		
11	1061	Thermostat 82° C	1		
11	1320	Thermostat 88° C	1		
12	291294	Gasket thermostat housing.	1		
13	289265	Cover thermostat housing.	1		
14	9191	Stud cover to thermostat housing.	3		
15	212194	Spring washer	3		
16	2303	Nut	3		
17	2753	Thermostat housing	1		
18	9780	Gasket thermostat housing to cylinder head.	1		
19	212194	Spring washer	2		
20	10718	Bolt thermostat housing with casting no. 202033.	2		
20	6501	Bolt thermostat housing with casting no. THA1000/00 or THA5000/00.	2		
21	1430	Thermostat 74° C	1		TR2 from TS1201, TR3, TR3A, TR3B, TR4 and TR4A
21	1061	Thermostat 82° C	1		
21	1320	Thermostat 88° C	1		
22	9780	Gasket thermostat housing.	1		
23	257	Cover thermostat housing.	1		
24	9191	Stud cover to thermostat housing.	2		
25	212194	Spring washer	2		
26	2303	Nut	2	TR2 from TS1201, TR3, TR3A, TR3B, TR4 and TR4A. May replace bolt and nut (ill. 24 and 26)	
27	6522	Bolt cover to thermostat housing	2		
28	2216	Thermal transmitter for temperature gauge	1	TR4 and TR4A	
29	1864	Radiator hose top - thermostat to radiator.	1		
30	201051	Bypass hose	1	TR2, TR3, TR3A und TR3B	
31	4157	Radiator hose intermediate - water pump to pipe.	1		
32	201066	Water pipe mild steel.	1	TR4 and TR4A	
32	12054	Water pipe stainless steel.	1		
33	4157	Radiator hose bottom - water pipe to radiator	1	Alternatives	
33	316055	Radiator hose bottom - water pipe to radiator	1		
34	20317	Hose clip wire type - large	6	Alternatives	
34	208951	Hose clip worm type - large	6		
35	1552	Hose clip wire type - small.	2	Original bellows type	
35	208949	Hose clip worm type - small.	2		
36	289354	Thermostat 74°	1	Original bellows type	
36	289353	Thermostat 86°	1		



Digital infrared thermometer
 with built-in laser pointer for exact measurement. Temperature range from -20 to + 520°C or -4 to 968°F. Accuracy: +/-2°C or 2% of the reading. Response time: 500 mSec. Resolution: 0.2°. Now with an easy-to-use pistol design and illuminated display. Suitable for a lot of tasks around the car and workshop, 9V batterie included.
Check the temperature of the engine, muffler, tires and brakes.
Which cylinder is getting hot?
A fast detection of faulty components can save time and prevent expensive repairs and severe damage.
 Part no. 306497

4.4

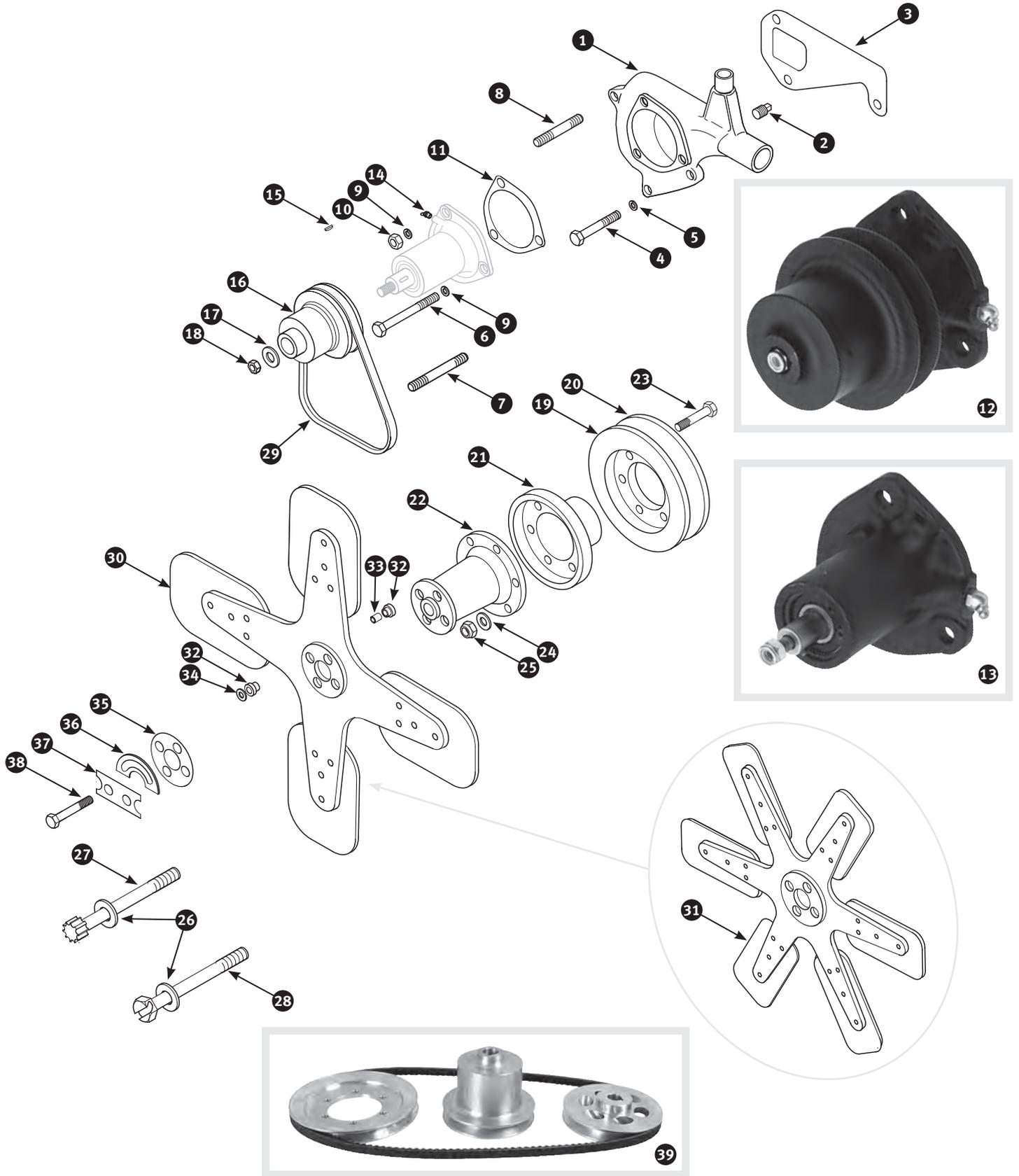



No	Part No	Description	Qty	Notes
1	327486	Water pump housing new item	1	
1	212331	Water pump housing used item	1	
2	14245	Blanking plug water pump housing	1}	cars without heater
3	9700	Gasket water pump housing to cylinder block	1	
4	6509	Bolt water pump housing to cylinder block	2	
5	2051	Spring washer	2	
6	6510	Bolt water pump to housing and cylinder block	1}	Use when water pump with removable pulley is fitted
7	9667	Stud water pump to housing and cylinder block	1}	Use when water pump with pressed-on pulley is fitted
8	12825	Stud water pump to housing	2	
9	2051	Spring washer	3	
10	3073	Nut	2}	Use when water pump with removable pulley is fitted
10	3073	Nut	3}	Use when water pump with pressed-on pulley is fitted
11	4028	Gasket water pump to housing	1	
12	212225	Water pump with pulley assembly	1	
13	1421	Water pump without pulley	1	
14	5139	Grease nipple water pump	1	
15	17977	Woodruff key pulley	1	
16	3320	Pulley water pump	1	
17	9204	Plain washer	1	
18	329880	Steel nut pulley	1	
19	10679	Pulley crankshaft, front half	1}	Dished
20	10701	Pulley crankshaft, rear half	1}	Flat
21	21384	Flange pulley	1	
22	16405	Extension fan	1}	TR2, TR3, TR3A and TR3B
22	16406	Extension fan	1}	TR4 and TR4A
23	3938	Bolt	6	
24	212191	Plain washer	6	
25	212451	Nyloc nut	6	
26	11305	Shim centre bolt	0}	Quantity as required
27	16478	Centre bolt with starting handle slot	1}	TR2, TR3, TR3A and TR3B
27	5318	Centre bolt with starting handle slot	1}	TR4 and TR4A
28	299879	Centre bolt without starting handle slot	1}	TR4A.If not available use centre bolt 5318 (ill. 27)
29	1006	Fan belt - version with regular length	1}	Alternatives
29	313588	Fan belt - extra long version	1}	
30	16404	Fan blade 4 blade metal	1}	TR2, TR3, TR3A and TR3B
30	10016	Fan blade 4 blade metal	1}	TR4 and TR4A
31	19482	Fan blade 6 blade metal	1}	Various TR4 and TR4A.If not available use fan blade 10016 (ill. 30)
32	2275	Rubber bush fan blade	8	
33	236	Sleeve fan blade	4	
34	212193	Plain washer	4	
35	17204	Lock plate centre bolt	1	
36	17205	Balance piece fan blade	1	
37	5085	Lock tab bolt to extension	2	
38	6522	Bolt fan blade retaining	4	
39	15523	Conversion kit to narrow fan belt. Containing 3 pulleys and 1 fan belt.	1}	An electric fan is not necessary

No	Part No	Description	Qty	Notes
1	20766	Accelerator pedal with shaft	1	} TR2 to TR3B - RHD models
1	300114	Accelerator pedal with shaft	1	
2	21104	Bracket pedal shaft	2	} TR2 to TR3B - RHD models
2	300675	Bracket pedal shaft	2	
3	3120	Pointed screw bracket to bulkhead	4	} RHD models
4	212192	Spring washer	4	
5	10844	Plain washer pedal shaft adjustment	2	
6	2185	Double coil washer pedal shaft adjustment	1	
7	3269	Split pin	2	
8	15920	Nylon bush	1	
9	201120	Retainer plate	2	
10	20031	Self tapping screw	4	
11	215770	Lever assembly	1	
12	9654	Roll pin	1	
13	3309	Return spring accelerator lever	1	
14	7889	Screw pedal stop.	1	
15	7656	Nut	1	
16	3120	Pointed screw	3	
17	212192	Spring washer	3	
18	10242	Blanking plug for not used hole in retainer plate	1	
19	367366	Accelerator pedal new item	1	
19	201474	Accelerator pedal used item	1	
20	359467	Shaft accelerator pedal	1	} TR3A from TS29821, TR3B, TR4 and TR4A - LHD models
21	300648	Connector pedal to shaft	1	
22	295972	Accelerator pedal with shaft	1	
23	300658	Bush pedal shaft	1	
24	9654	Roll pin	2	
25	15920	Nylon bush pedal shaft	2	
26	201120	Retainer plate	4	
27	20031	Self tapping screw	8	
28	300117	Bracket pedal shaft	1	
29	212192	Spring washer	2	
30	3120	Pointed screw bracket to bulkhead	2	} LHD models
31	10844	Plain washer pedal shaft adjustment	1	
32	2185	Double coil washer pedal shaft adjustment	1	
33	3269	Split pin	1	
34	215770	Lever assembly	1	
35	9654	Roll pin	1	
36	3309	Return spring accelerator lever	1	
37	7889	Screw pedal stop.	1	
38	7656	Nut	1	
39	13867	Choke cable less knob	1	
40	3949	Knob choke cable	1	
41	19656	Choke cable without knob	1	} TR4 and TR4A
42	16910	Knob choke cable	1	
43	26169	Grommet choke cable through bulkhead	1	} TR2 with SU-H4 carburetors TR3, TR3A, TR3B and TR4 with SU-H6 carburetors
44	5742	Trunnion choke cable.	1	
45	19655	Trunnion choke cable.	1	
46	1585	Trunnion choke cable.	1	} TR4 and TR4A with SU-HS6 or Zenith Stromberg 175CD carburetors

6.1

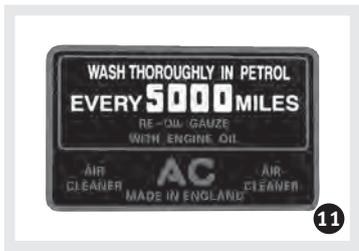
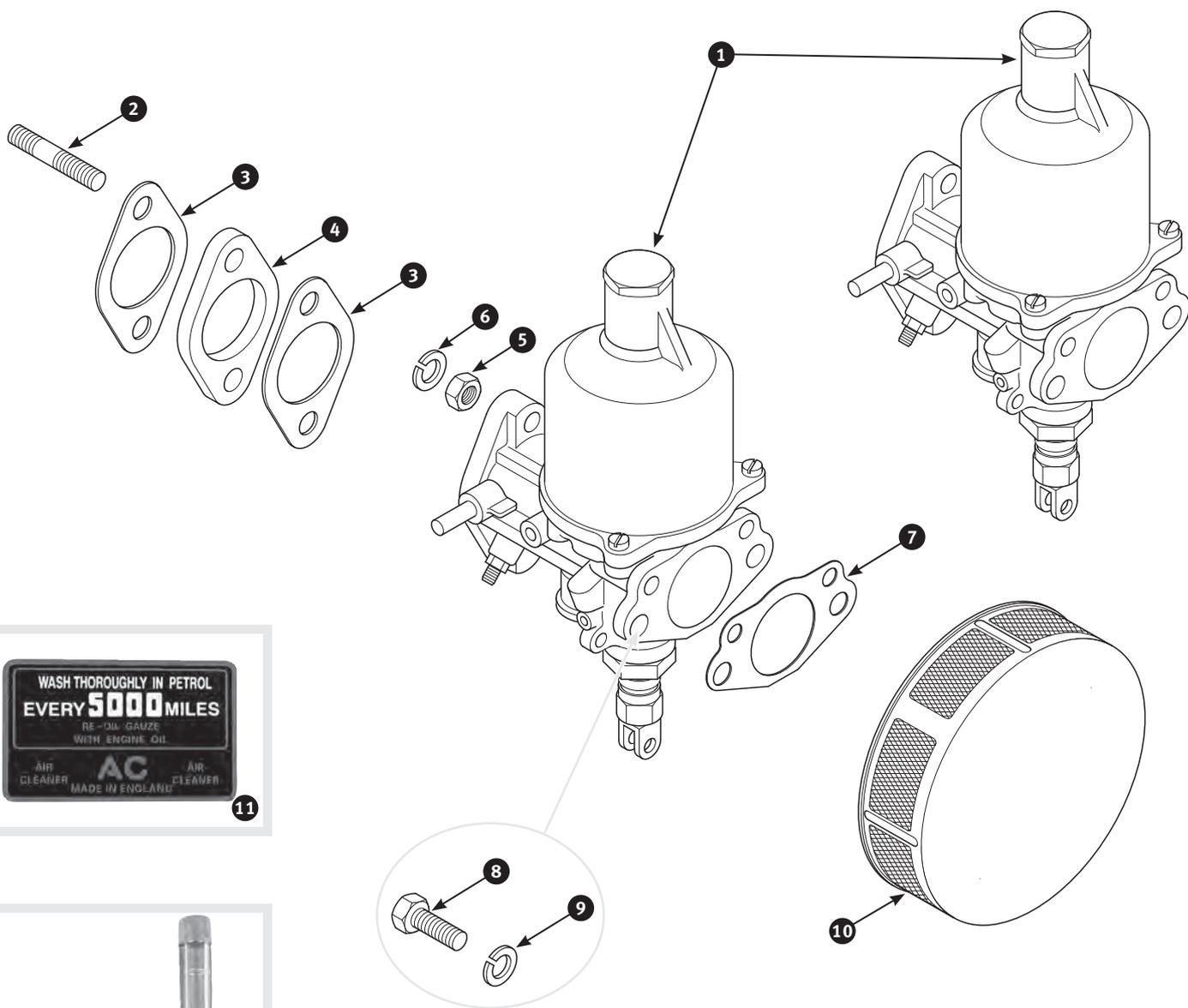

11



12

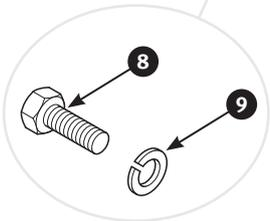

13

No	Part No	Description	Qty	Notes
1	304367	SU Carburettors H4 type - new items.	1	} Alternatives
1	20527	SU Carburettors H4 type - exchange	1	
2	2332	Stud	4	
3	5851	Gasket inlet manifold to carburettor	4	
4	16635	Distance collar inlet manifold to carburettor.	2	
5	2051	Spring washer	4	
6	3952	Nut	4	
6	201055	Brass nut	4	
7	1155	Gasket air filter to carburettor.	2	
8	2826	Screw air filter to carburettor	4	
9	212194	Spring washer	4	
10	234	Air filter	2	
11	18525	Sticker air filter ,wash every 5000 miles'	2	
12	19729	Carburettor balancer for SU carburettors - alloy die cast type.	1	
13	20661	Tool kit three-piece including jet linkage spanner	1	



Carburettor cleaner
 500 ml aerosol
 Part no. 316230



Carburettor damper oil
 125 ml bottle. For post 1950 vehicles with SU and Zenith Stromberg carburettors
 Part no. 212128

Order free of charge:

Oils and lubricants catalogue



6.2

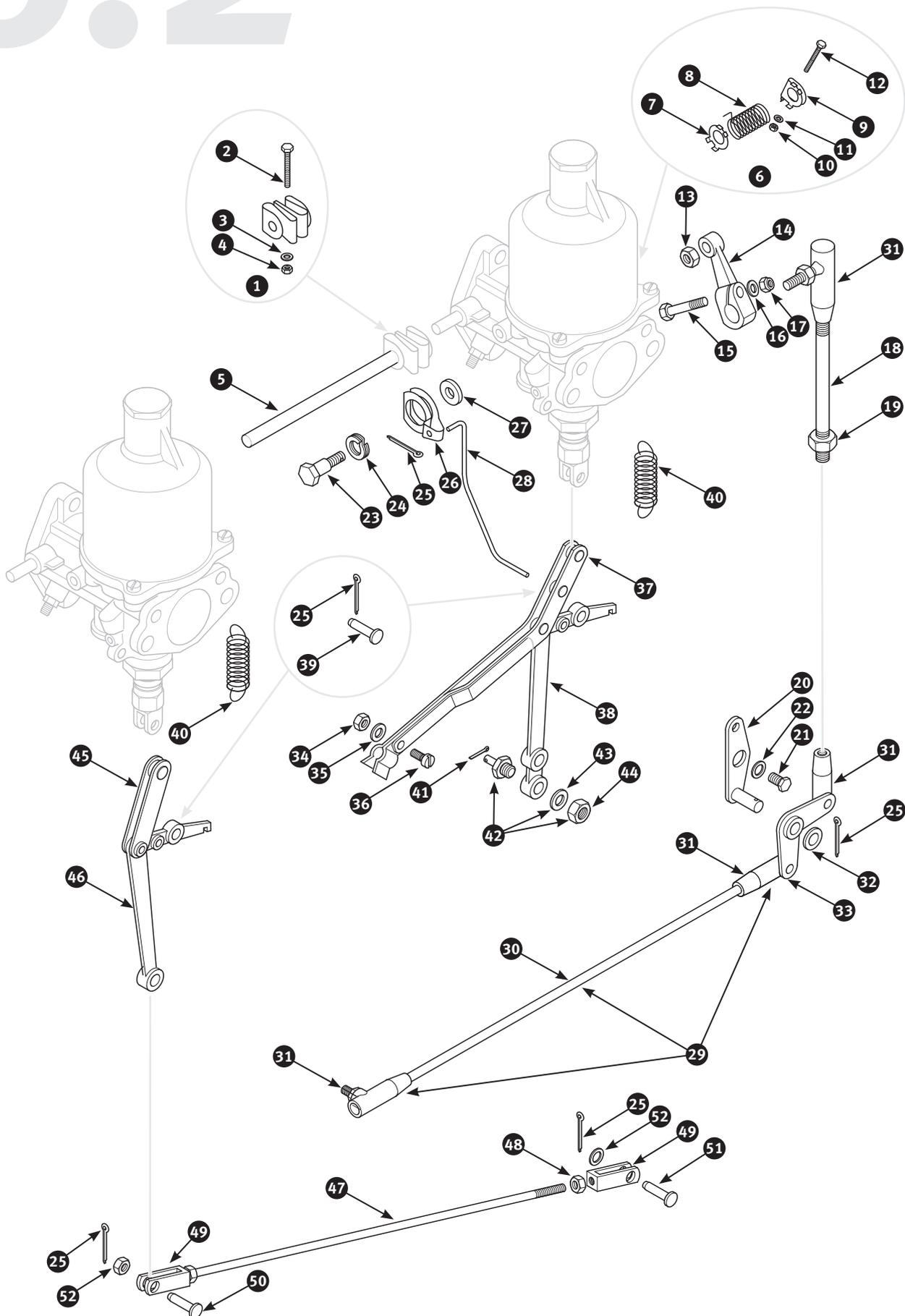

No	Part No	Description	Qty	Notes
1	14054	Coupling link throttle spindle	2	
2	214079	Bolt on coupling link	4	
3	19383	Plain washer	4	
4	6309	Nut	4	
5	6406	Connecting rod between throttle spindles	1	} Connecting rod must be cut to length
6	288819	Repair kit carburettor return spring	2	
7	326948	Bracket separately	2	
8	1423	Return spring separately	2	
9	1791	Retaining clip separately	2	
10	6309	Nut separately	2	
11	19383	Plain washer separately	2	
12	214079	Bolt separately	2	
13	7656	Nut	1	
14	210051	Lever throttle shaft - original type	1	} Alternatives
14	204938	Lever throttle shaft - replacement	1	
15	212883	Screw	1	
16	19383	Plain washer	1	
17	6309	Nut	1	
18	337519	Throttle linkage to connecting rod	1	
19	7741	Nut	1	
20	21383	Pivot bolt with plate	1	
21	7893	Screw	1	
22	212194	Spring washer	1	
23	1444	Adjusting bolt fast idle	1	
24	6306	Double coil washer	1	
25	3805	Split pin	10	
26	20529	Lever fast idle	1	
27	1447	Aluminium washer	1	
28	16712	Connection link fast idle	1	
29	9742	Connecting rod throttle linkage - with joints assembly	1	
30	11798	Connecting rod throttle linkage - without joints	1	
31	25367	Joint	4	
32	212193	Plain washer	1	
33	21382	Lever bell crank	1	
34	6308	Nut	1	
35	212190	Spring washer	1	
36	220220	Screw	1	
37	19375	Connection link front carburettor jet lever - support choke cable . .	1	
38	17971	Lever front carburettor jet - support jet return spring	1	
39	1844	Clevis pin	5	
40	1417	Return spring choke	2	
41	3805	Split pin securing trunnion	1	
42	5742	Trunnion complete with nut and washer	1	
43	7793	Plain washer	1	
44	3783	Nyloc nut	1	
45	20528	Connection link rear carburettor jet lever	1	
46	2126	Lever rear carburettor jet - support jet return spring	1	
47	20534	Connecting rod jet lever	1	
48	6308	Nut	2	
49	1458	Fork connecting rod	2	
50	1438	Clevis pin	1	
51	1844	Clevis pin	1	
52	212189	Plain washer	2	

No	Part No	Description	Qty	Notes
1	220264	Tapper pin	2	
2	299807	Lever throttle stop rear carburettor	1	
3	299806	Lever throttle stop front carburettor	1	
4	1795	Adjusting screw idle control	3	
5	1789	Spring idle control	3	
6	20105	Steel bush throttle spindle	4	} For bodies with worn cast in bushes } With standard size. Lengths: 115 mm } With 0.010" oversize. Lengths: 235 mm
7	323998	Hand reamer for 5/16" throttle spindles	1	
8	23031	Hand reamer for 5/16" throttle spindles	1	
9	2734	Throttle disc without valve	2	
10	1420	Screw throttle disc retaining	4	
11	2584	Throttle spindle - standard	2	
11	20716	Throttle spindle - oversize	2	
12	299754	Carburettor body front carburettor	1	
12	22595	Carburettor body rear carburettor	1	
13	1843	Adaptor vacuum advance - front carburettor	1	
14	1121	Jet bearing kit assembly	2	
15	1441	Copper washer	2	
16	6411	Jet bearing upper	2	
17	6410	Cork gland	4	
18	1425	Brass gland	4	
19	1413	Spring	2	
20	2929	Cork gland	2	
21	1439	Aluminium washer	2	
22	6412	Jet bearing lower	2	
23	1443	Copper washer	2	
24	1733	Adjusting nut	2	
25	1422	Spring jet bearing	2	
26	1440	Gland sealing nut	2	
27	1122	Main jet	2	
28	1438	Clevis pin	2	
29	3805	Split pin	2	
30	220430	Seal kit jet bearing	2	} Contains all sealing rings and washer
31	313840	Gasket kit for single carburettor	2	
32	200205	Service kit for single carburettor	2	
33	25502	Rebuilt kit for single carburettor	2	} Comprising service kit 200205 plus throttle disc and throttle spindle
34	299764	Dashpot with piston	2	
35	3573	Screw dash pot cover	4	
36	20652	Dashpot damper with brass head	2	} Alternatives
36	16340	Dashpot damper with plastic head	2	
37	202111	Fibre washer	2	
38	755	Dashpot spring red	2	
39	1442	Thrust washer Dashpot spring	2	
40	8138	Lifting pin with spring - carburettor piston	2	



Fuel pressure regulator

85 mm specification, glass body. The ideal way to control the flow and pressure of the fuel delivered to the carburettor. Pressure range from 1.5 PSI up to 5 PSI.

Part no. 15395

spare filter: 327900

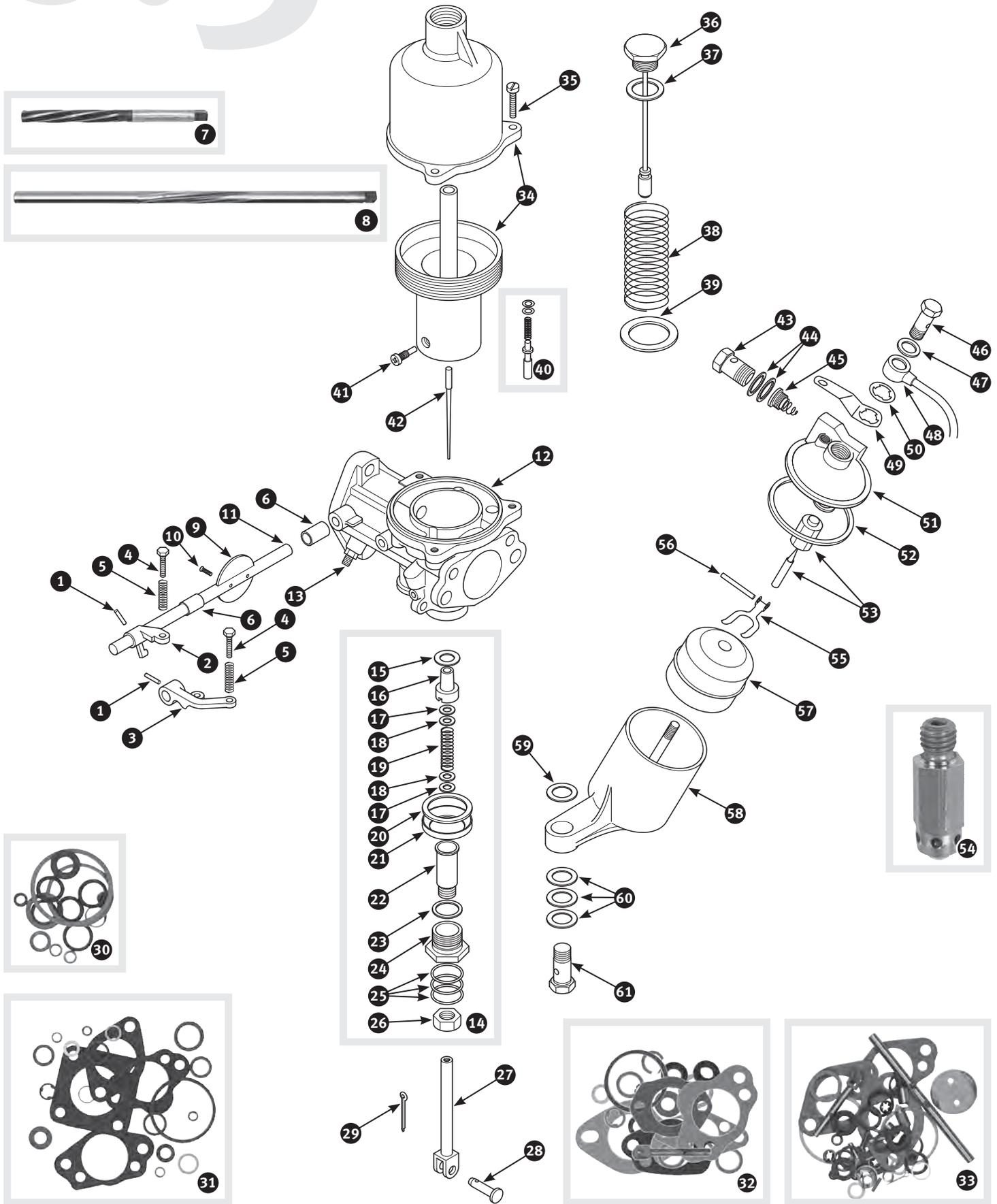

No	Part No	Description	Qty	Notes
41	289785	Adjusting screw metering needle.	2	
42	1496	Metering needle fixed - FV - standard	2	
42	299536	Metering needle fixed - GER - rich	2	
42	449417	Metering needle fixed - CR - weak	2	
43	754	Banjo bolt	2	
44	202111	Fibre washer	4	
45	1788	Filter and spring	2	
46	1811	Banjo bolt float lid	2	
47	2284	Aluminium washer	2	
48	20536	Overflow pipe float chamber.	2	
49	289786	Sealing washer with support.	2	
50	2253	Fibre washer	2	} May replace sealing washer 289786 (ill 49) if not available
51	20670	Float chamber lid	2	} With needle valve, pin and float lever
52	16356	Gasket float chamber.	2	
53	16335	Needle and seat assembly	2	
54	19687	Grose jet	2	} Superior replacement of needle valve and seat
55	1697	Lever float	2	} Fits to the original float lid } Fits to replacement float lid 20670 (ill 51)
55	3141	Lever float	2	
56	1810	Pin on float.	2	
57	1123	Float with gasket.	2	
58	2198	Float chamber	2	
59	1412	Fibre washer	2	
60	20533	Washer set float chamber to body.	2	} Contains 2x fibre washers and 1x steel washer
61	1436	Banjo bolt float chamber to body	2	



6.4

Carburettor and air filter

SU-H6 carburettor and air filter - TR3, TR3A, TR3B and TR4

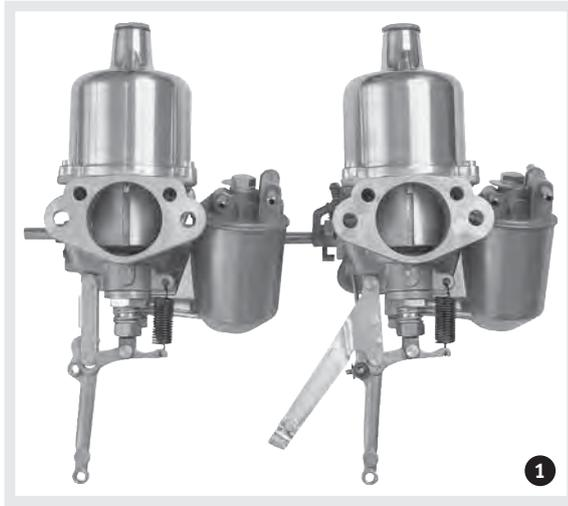

1

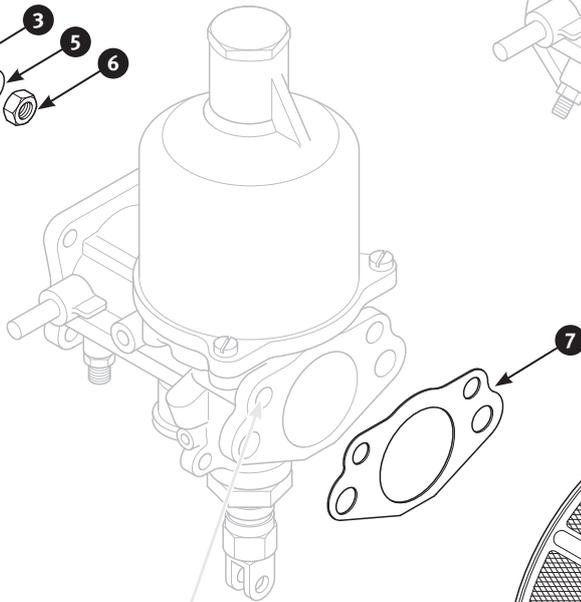
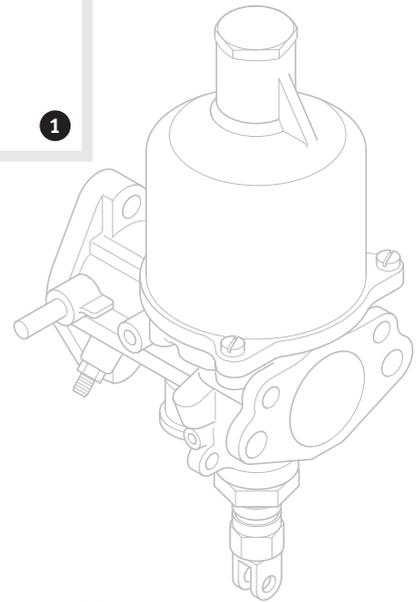
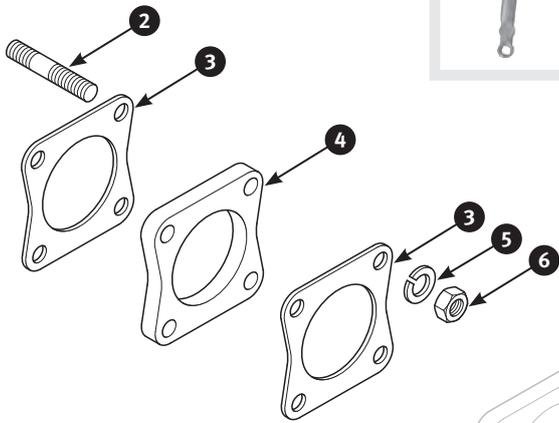

7

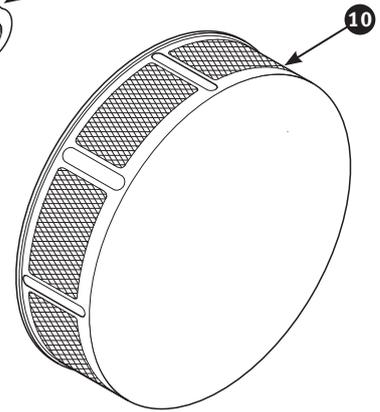

10



11



12

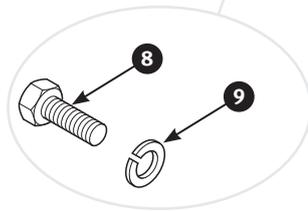

8

9

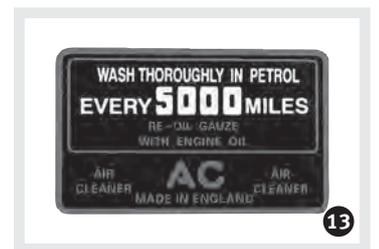

13

No	Part No	Description	Qty	Notes
1	304368	Carburetors H6 type - new items	1	} TR3, TR3A to 1959 - identify by float lid with banjo bolt to adapt overflow pipe
1	299035	Carburetors H6 type - exchange	1	
1	213598	Carburetors H6 type - new items	1	} TR3A from 1959 and TR4 - identify by float lid with push-on to adapt overflow pipe
1	452750	Carburetors H6 type - exchange	1	
2	7293	Stud carburettor to inlet manifold	8	
3	5099	Gasket carburettor to inlet manifold	4	
4	326159	Spacer block carburettor to inlet manifold	2	
5	212194	Spring washer	8	
6	2303	Nut	8	
7	5528	Gasket air filter to carburettor.	2	
8	2826	Screw air filter to carburettor	4	
9	212194	Spring washer air filter to carburettor	4	
10	210537	Air filter	2	
11	212128	Carburettor damper oil 125 ml bottle.	1	} For further information see chapter 21.8
12	316230	SU Carburettor cleaner 500 ml aerosol.	1	
13	18525	Sticker air filter ,wash every 5000 miles'	2	

Carburettor balancer

for SU carburetors - alloy die cast type
Part no. 19729



SU Air filter

for SU-H6 and SU-HS6 carburetors, round, centre type, 45 mm deep, chromed
Part no. 215269



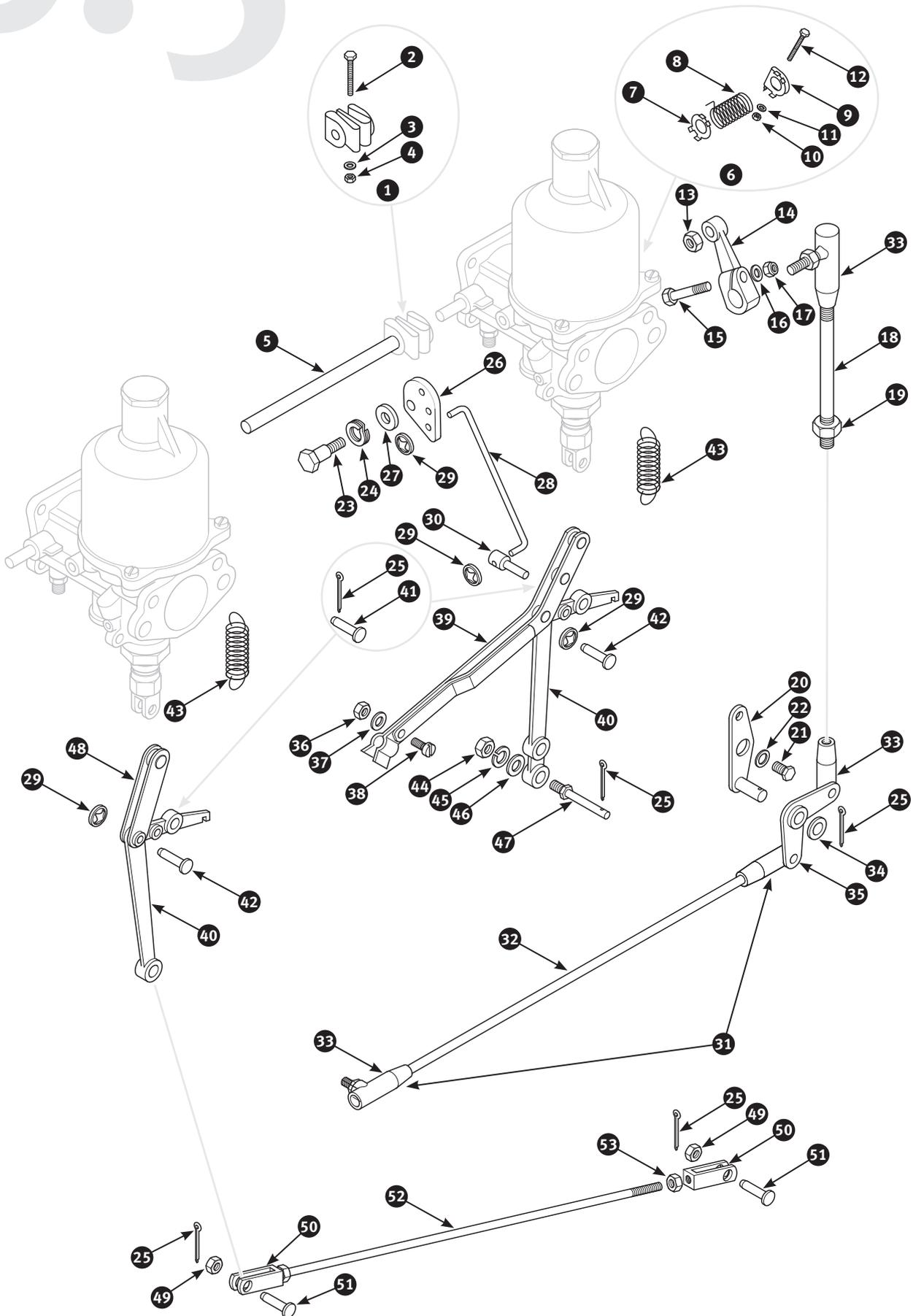

No	Part No	Description	Qty	Notes
1	14054	Coupling link throttle spindle	2	
2	214079	Bolt on coupling link	4	
3	19383	Plain washer	4	
4	6309	Nut	4	
5	4025	Coupling shaft between throttle spindles	1	
6	288819	Repair kit carburettor return spring	2	
7	326948	Bracket separately	2	
8	1423	Return spring separately	2	
9	1791	Retaining clip separately	2	
10	6309	Nut	2	
11	19383	Plain washer	2	
12	214079	Bolt on coupling link	2	
13	7656	Nut	1	
14	210051	Lever throttle shaft - original type	1	} Alternatives
14	204938	Lever throttle shaft - replacement	1	
15	212883	Screw	1	
16	19383	Plain washer	1	
17	6309	Nut	1	
18	337519	Throttle linkage to connecting rod	1	
19	7741	Nut	1	
20	21383	Pivot bolt with plate	1	
21	7893	Screw	1	
22	212194	Spring washer	1	
23	1444	Adjusting bolt fast idle	1	
24	6306	Double coil washer	1	
25	3805	Split pin	7	
26	1446	Cam fast idle	1	
27	1447	Aluminium washer	1	
28	220312	Connection link fast idle	1	
29	1448	Locking washer	5	
30	220309	Pivot bolt	1	
31	9742	Connecting rod throttle linkage - with joints assembly	1	
32	11798	Connecting rod throttle linkage - without joints	1	
33	25367	Joint	4	
34	212193	Plain washer	1	
35	21382	Lever bell crank	1	
36	6308	Nut	1	
37	212190	Spring washer	1	
38	220220	Screw	1	
39	300826	Connection link front carburettor jet lever - support choke cable	1	
40	752	Lever front carburettor jet - support jet return spring	1	
41	1844	Clevis pin	3	
42	1735	Clevis pin	2	
43	1417	Return spring	2	
44	317461	Nyloc nut	1	
45	212190	Spring washer	1	
46	7793	Plain washer	1	
47	19655	Trunnion choke cable	1	
48	13625	Connection link rear carburettor jet	1	
49	212189	Plain washer	1	
50	1458	Fork connecting rod	2	
51	1438	Clevis pin	1	
52	20534	Connecting rod jet lever	1	
53	6308	Nut	2	

6.6

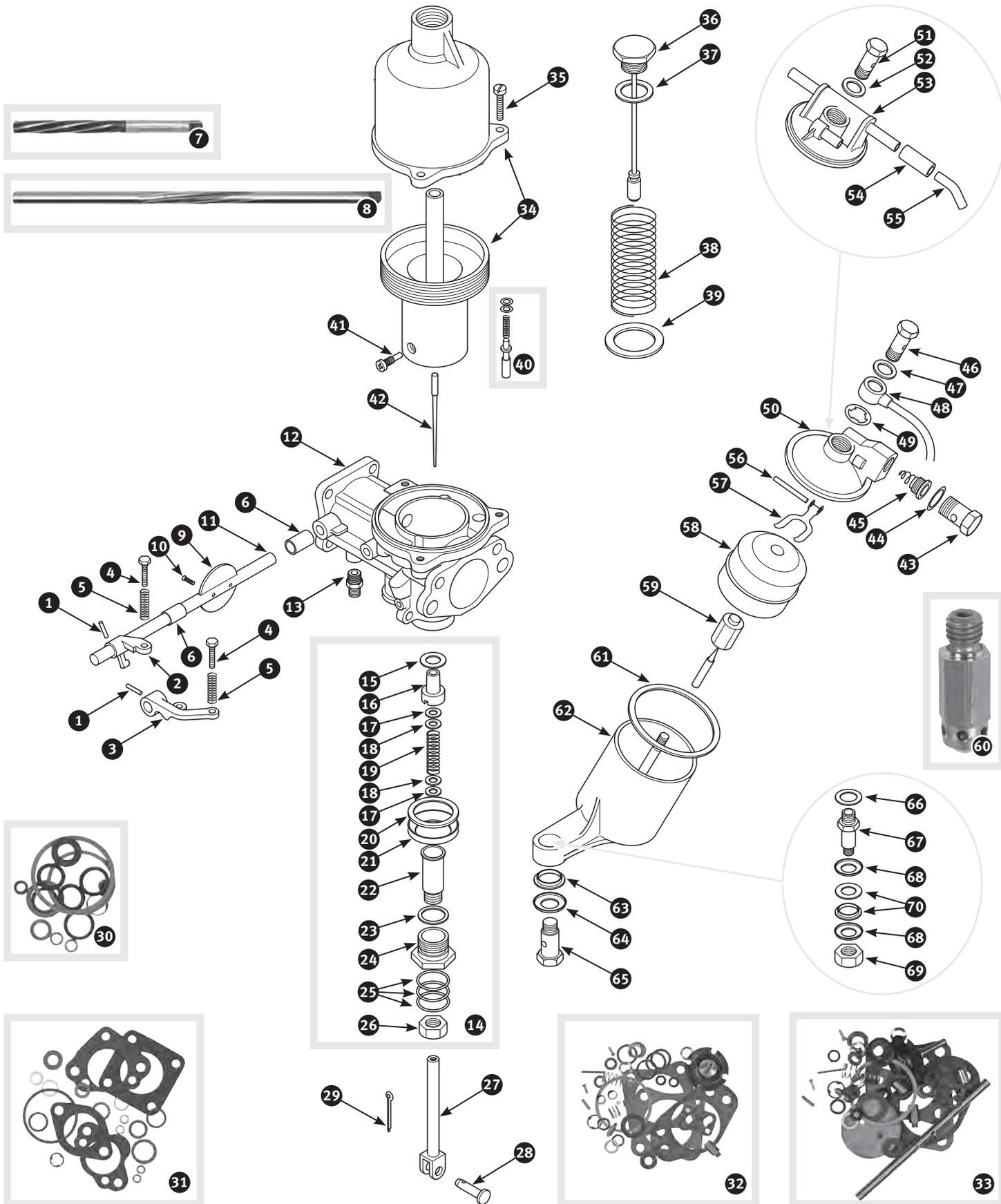

No	Part No	Description	Qty	Notes
1	220264	Tapper pin	2	
2	299807	Lever throttle stop rear carburettor	1	
3	21374	Lever throttle stop front carburettor	1	
4	1795	Adjusting screw idle control	3	
5	1789	Spring idle control	3	
6	20105	Steel bush throttle spindle	4	} For bodies with worn cast in bushes } With standard size. Lengths: 115 mm } With 0.010" oversize. Lengths: 235 mm
7	323998	Hand reamer for 5/16" throttle spindles	1	
8	23031	Hand reamer for 5/16" throttle spindles	1	
9	1119	Throttle disc	2	
10	1420	Screw throttle disc retaining	4	
11	1460	Throttle spindle - standard	2	
11	21442	Throttle spindle - 0.010" oversize	2	
12	302771	Carburettor body front	1	
12	299029	Carburettor body rear	1	
13	1843	Adaptor vacuum advance - front carburettor	1	
14	1121	Jet bearing kit assembly	2	
15	1441	Copper washer	2	
16	6411	Jet bearing upper	2	
17	6410	Cork gland	4	
18	1425	Brass gland	4	
19	1413	Spring	2	
20	2929	Cork gland	2	
21	1439	Aluminium washer	2	
22	6412	Jet bearing lower	2	
23	1443	Copper washer	2	
24	1733	Adjusting nut	2	
25	1422	Spring jet bearing	2	
26	1440	Gland sealing nut	2	
27	1402	Main jet	2	
28	1438	Clevis pin	2	
29	3805	Split pin	2	
30	220430	Seal kit jet bearing	2	} Contains all sealing rings and washer
31	18125	Gasket kit for single carburettor	2	
32	200206	Service kit for single carburettor	2	
33	25503	Rebuilt kit for single carburettor	2	} Comprising service kit 200206 plus throttle disc and throttle spindle
34	299939	Dashpot with piston	2	
35	3573	Screw dash pot cover	4	
36	19521	Damper brass	2	
37	202111	Fibre washer	2	
38	755	Dashpot spring red	2	
39	1442	Thrust washer Dashpot spring	2	
40	8138	Lifting pin with spring - carburettor piston	2	

4 Catalogues, you must have:

- Oils and lubricants
- Tuning and more
- Accessories
- Tools



Order online: www.Limora.com • www.scparts.co.uk

6.6

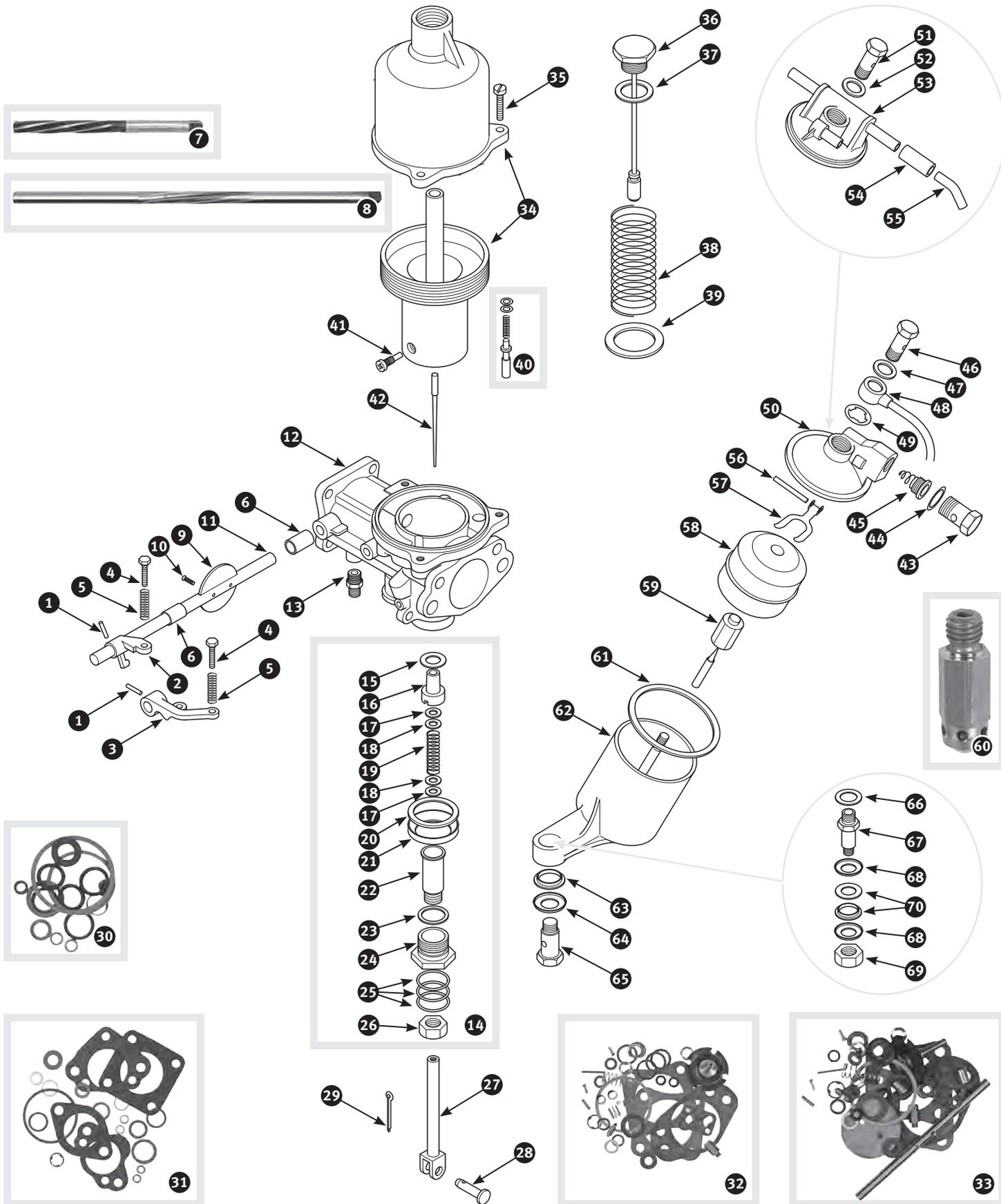

No	Part No	Description	Qty	Notes
41	289785	Adjusting screw metering needle.	2	
42	1418	Metering needle fixed - SM - standard	2	
42	1495	Metering needle fixed - RH - rich	2	
42	20654	Metering needle fixed - SL - weak	2	
43	1811	Banjo bolt float lid	2	} TR3, TR3A to 1959 - identify by float lid with banjo bolt to adapt overflow pipe
44	3053	Fibre washer float lid	4	
45	1788	Filter and spring	2	
46	1811	Banjo bolt overflow pipe	2	
47	2284	Aluminium washer	2	
48	20536	Overflow pipe float lid	2	
49	2253	Fibre washer	2	
50	20669	Float chamber lid front and rear carburettor.	2	
51	204022	Cap nut float lid	2	
52	2284	Aluminium washer	2	
53	300089	Float chamber lid front carburettor	1	} TR3A from 1959 and TR4 - identify by float lid with push-on to adapt overflow pipe
53	300090	Float chamber lid rear carburettor.	1	
54	5256	Stub pipe overflow pipe to carburettor	2	
55	300002	Overflow pipe carburettor.	2	} Superior replacement of needle valve and seat
56	1810	Pin on float.	2	
57	3141	Lever float	2	
58	1123	Float with gasket.	2	
59	16335	Needle and seat assembly	2	} Superior replacement of needle valve and seat
60	19687	Grose jet	2	
61	16356	Gasket float chamber.	2	} TR3, TR3A to 1959 - identify by float lid with banjo bolt to adapt overflow pipe
62	2198	Float chamber	2	
63	1377	Sealing rubber	4	
64	220232	Aluminium washer	2	
65	19311	Banjo bolt float chamber to carburettor body.	2	
66	3297	Fibre washer	2	
67	6404	Banjo bolt float chamber to carburettor body.	2	
68	212195	Plain washer	2	
69	6310	Steel nut	2	
70	1377	Sealing rubber	4	



Mitsuba
the fuel pump . . .
 easy installation
 integrated fuel filter, pos. or neg. earth.
 Self regulating pressure with bypass
 Part no. 14976
 Spare filter 212850

6.7

And also some earlier test series models from CT16800E to CT16900E

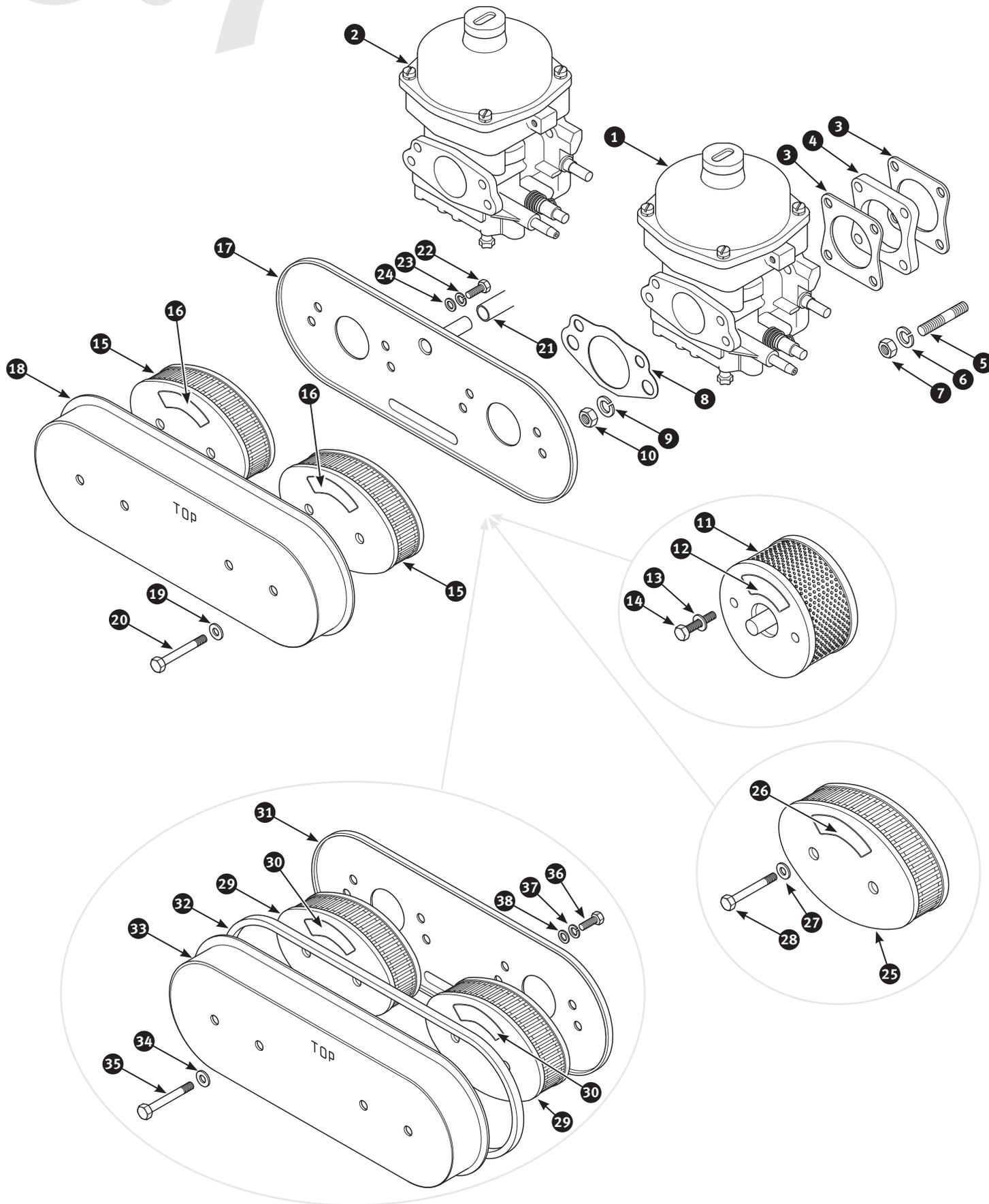

No	Part No	Description	Qty	Notes
1	297779	Zenith Stromberg Carburettor 175CD, front - exchange.	1	} TR4, carburettor reference no. C1825
2	290543	Zenith Stromberg Carburettor 175CD, rear - exchange	1	
1	269941	Zenith Stromberg Carburettor 175CD, front - exchange.	1	} TR4A, carburettor reference no. 3043
2	269942	Zenith Stromberg Carburettor 175CD, rear - exchange	1	
1	11815	Zenith Stromberg Carburettor 175CD, front - exchange.	1	} TR4A, carburettor reference no. 3069
2	11816	Zenith Stromberg Carburettor 175CD, rear - exchange	1	
3	5099	Gasket carburettor to inlet manifold	4	
4	326159	Spacer block carburettor to inlet manifold	2	
5	7293	Stud carburettor to inlet manifold	8	
6	212194	Spring washer	8	
7	2303	Nut	8	
8	5528	Gasket air filter to carburettor.	2	} Cars with separate air filters
8	5528	Gasket air filter to carburettor.	6	
9	212194	Spring washer	4	
10	2303	Nut air filter to carburettor	4	
11	14188	Air filter element - round	2	} TR4 - identify by separate air filter with closed circuit breather system
12	21124	Sticker on air filter.	2	
13	212193	Plain washer	4	
14	213881	Bolt air filter to carburettor - length: 3"	2	
14	213915	Bolt air filter to carburettor - length: 2.3/4"	2	
15	2424	Air filter element - oval	2	
16	21444	Sticker on air filter.	2	
17	300444	Back plate air filter box	1	
18	300445	Cover air filter box.	1	} TR4 - identify by air filter box with closed circuit breather system
19	212193	Plain washer	4	
20	26515	Bolt air filter box to carburettor	4	
21	2411	Hose to air filter	1	
22	7884	Screw air filter box to cover	1	
23	212192	Spring washer	1	
24	212191	Plain washer	1	
25	2424	Air filter element - oval	2	
26	21444	Sticker on air filter.	2	} TR4A - standard equipment with separate air filters
27	212193	Plain washer	4	
28	213881	Bolt air filter to carburettor.	4	
29	2424	Air filter element - oval	2	
30	21444	Sticker on air filter.	2	
31	300446	Back plate air filter box	1	
32	5508	Sealing rubber cover to air filter box.	1	
33	300445	Cover air filter box.	1	
34	212193	Plain washer	4	
35	26515	Bolt air filter box to carburettor	4	
36	7884	Screw air filter box to cover	1	
37	212192	Spring washer	1	
38	212191	Plain washer	1	



Gear wrench sets

6 pieces: 7/16", 1/2", 9/16", 5/8", 11/16", 3/4"
Part no. 479871

12 pieces: 5/16", 3/8", 7/16", 1/2", 9/16", 5/8", 11/16", 3/4", 13/16", 7/8", 15/16", 1"
Part no. 479819

6.8

And also some earlier test series models from CT16800E to CT16900E

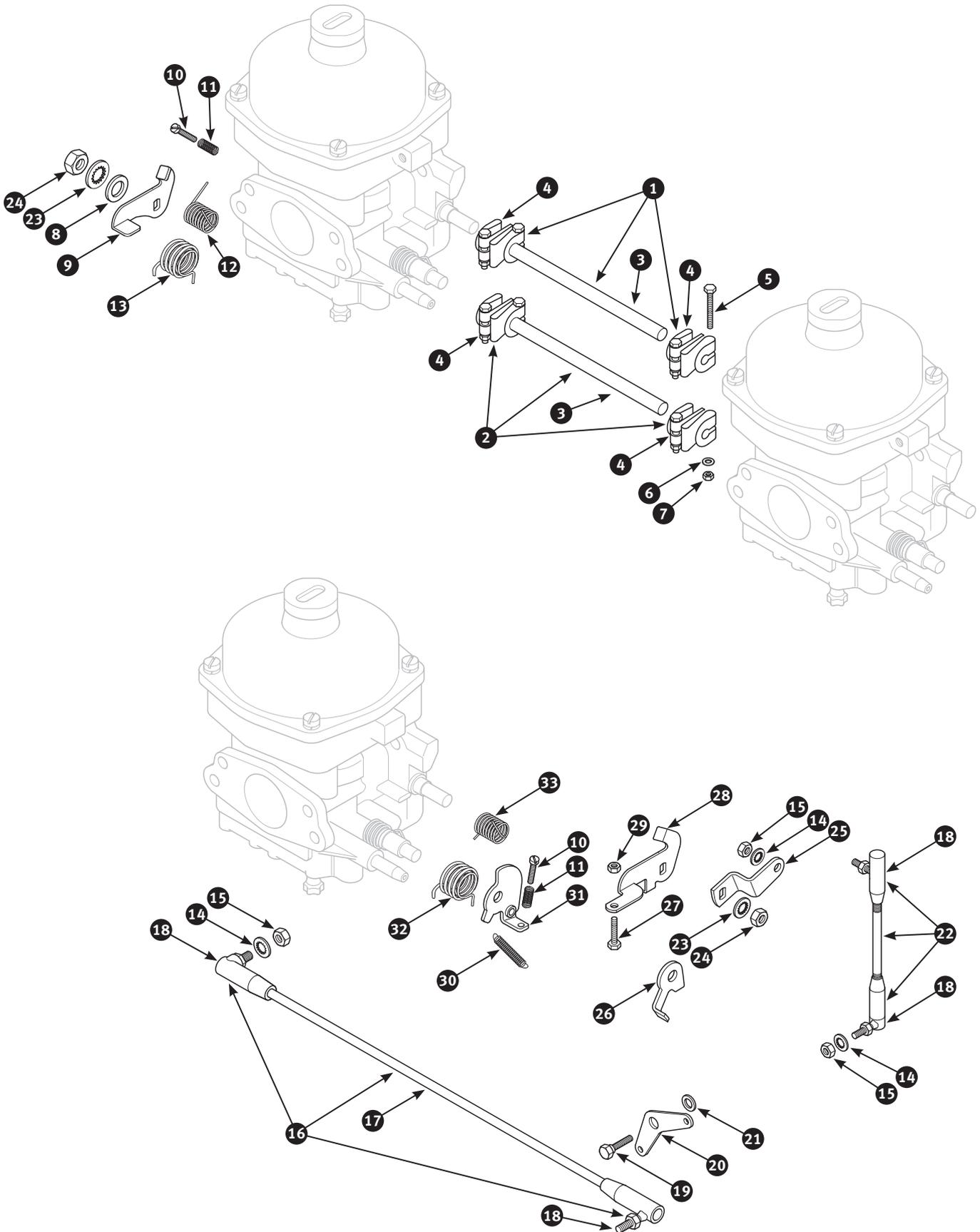

No	Part No	Description	Qty	Notes
1	300618	Connecting rod with links assembly.	1	} Coupling throttle spindles
3	6406	Connecting rod separately	1	
2	300619	Connecting rod with links assembly.	1	} Coupling starter spindles
3	6406	Connecting rod separately	1	
4	14054	Coupling link throttle spindle and starter bar	4	
5	214079	Bolt on coupling link	4	
4	19383	Plain washer	4	
7	6309	Nut	4	
8	21349	Washer with oval slot	1	
9	300617	Lever throttle stop rear carburettor	1	
10	373326	Screw throttle stop	1	
11	279760	Spring on throttle stop screw	2	
12	300612	Return spring throttle spindle - rear carburettor	1	
13	300616	Return spring starter bar - rear carburettor.	1	
14	212192	Spring washer	4	
15	7656	Nut	4	
16	9742	Connecting rod throttle linkage - with joints assembly	1	
17	11798	Connecting rod throttle linkage - without joints	1	
18	25367	Joint	4	
19	9753	Pivot bolt	1	
20	214451	Sector throttle link.	1	
21	212193	Plain washer	1	
22	337519	Throttle linkage to connecting rod.	1	
23	3542	Shakeproof washer throttle spindle and starter bar.	4	
24	3062	Nut throttle spindle and starter bar.	4	
25	300605	Lever throttle spindle.	1	
26	300606	Lever on starter bar cam	1	
27	9618	Adjusting screw fast idle	1	
28	300604	Lever throttle stop front carburettor	1	
29	19693	Locking nut	1	
30	300607	Spring fast idle	1	
31	300608	Cam starter bar - front carburettor.	1	
32	13399	Return spring starter bar - front carburettor	1	
33	300603	Return spring throttle spindle - front carburettor.	1	



And also some earlier test series models from CT16800E to CT16900E

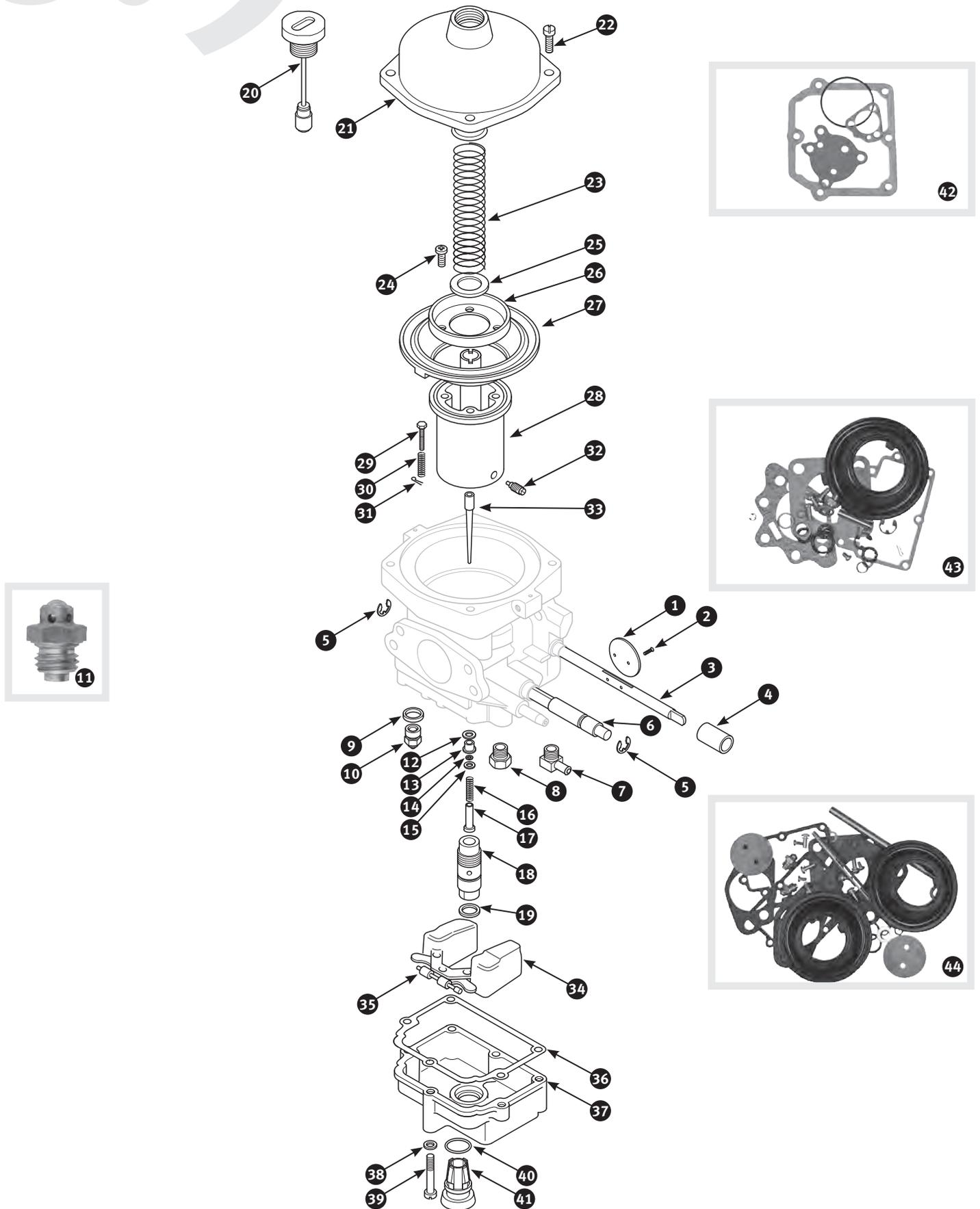

No	Part No	Description	Qty	Notes
1	10425	Throttle disc	2	
2	20049	Screw throttle disc retaining	4	
3	3108	Throttle spindle	2	
4	20105	Steel bush throttle spindle	4	} For bodies with worn cast in bushes
5	21351	Retaining clip starter shaft	4	
6	300609	Shaft starter - front carburettor	1	
6	300615	Shaft starter - rear carburettor	1	
7	21062	Connector vacuum advance - front carburettor	1	
8	300620	Blanking plug vacuum - rear carburettor	1	
9	21348	Sealing washer needle valve and seat	2	
10	290279	Needle valve and seat	2	
11	19686	Grose jet	2	} Superior replacement of needle valve and seat
12	21352	Plain washer	2	
13	21355	Bush carburettor jet	2	
14	14939	,O' ring	2	
15	13078	Plain washer	2	
16	21350	Spring carburettor jet	2	
17	11314	Jet carburettor	2	
18	13415	Adjusting nut jet carburettor	2	
19	18296	,O' ring	2	
20	210542	Dashpot damper	2	
21	302768	Cover carburettor	2	
22	10442	Panhead screw	8	
23	10550	Damper spring piston return	2	
24	18621	Panhead screw	8	
25	300611	Washer	2	
26	336360	Sealing ring diaphragm	2	
27	2459	Diaphragm	2	
28	299031	Piston carburettor	2	
29	300614	Lifting pin carburettor piston	2	
30	300613	Spring lifting pin	2	
31	21353	Clip lifting pin	2	
32	20050	Screw meeting needle fixing	2	
33	11313	Metering needle fixed - 2H	2	} TR4, carburettor reference no. C1825
33	1592	Metering needle fixed - 2E	2	} TR4A, carburettor reference no. 3043
33	14200	Metering needle fixed - 2A	2	} TR4A, carburettor reference no. 3069
34	21425	Float	2	
35	12877	Spindle float hinge	2	
36	21354	Gasket float chamber	2	
37	290200	Float chamber	2	
38	21347	Washer screw float chamber	8	
39	20085	Screw float chamber - long	10	
39	1827	Screw float chamber - short	6	
40	11365	,O' ring screw plug	2	
41	21356	Screw plug float chamber	2	
42	460220	Gasket kit services one carburettor	2	
43	447088	Service kit services one carburettor	2	
44	19017	Rebuilt kit services two carburettors	1	} Comprising service kit 447088 plus throttle discs and throttle spindles



Adjusting tool
for idle mixture screw on Zenith Stromberg carburetors
Part no. 19067

6.10

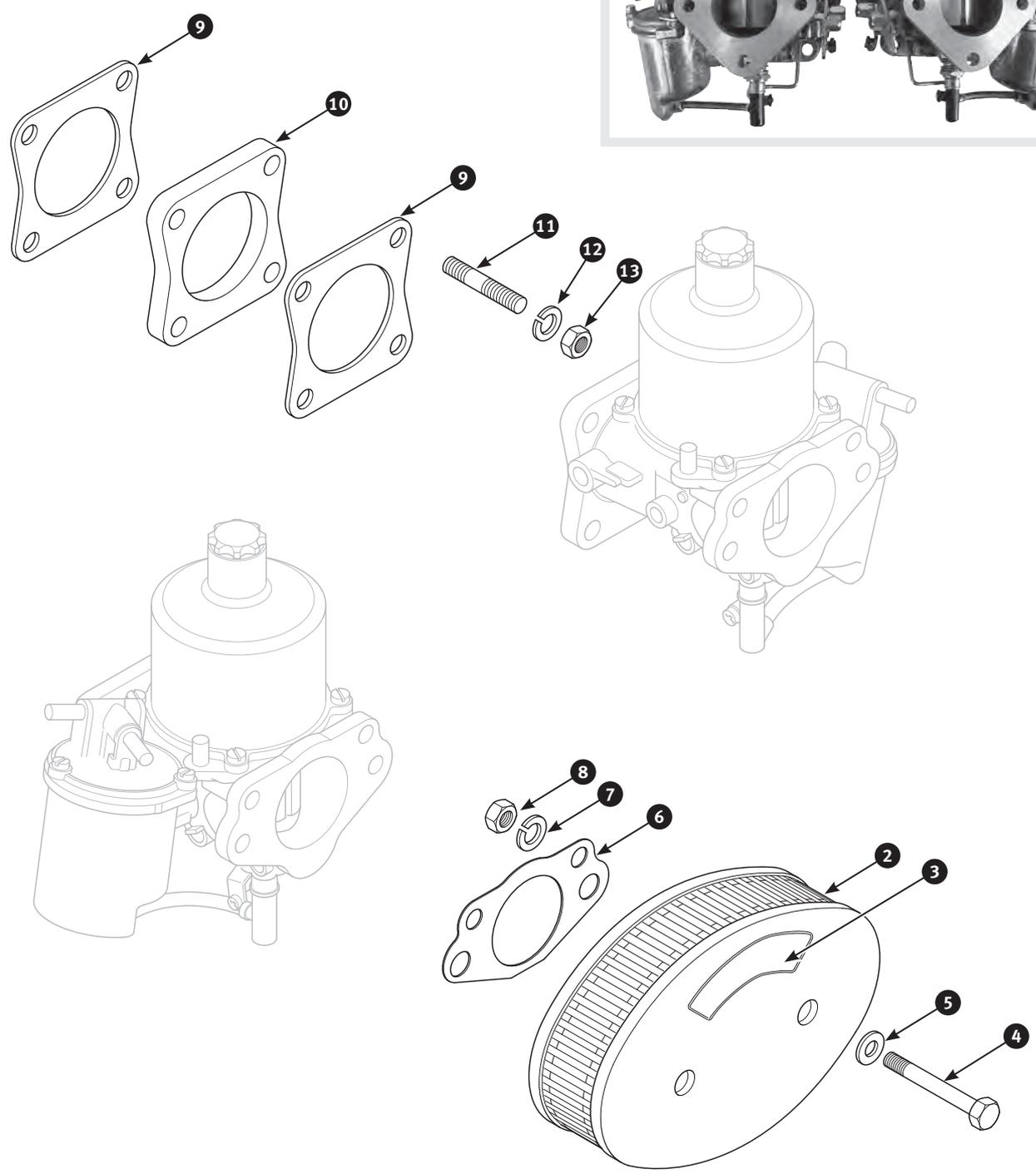
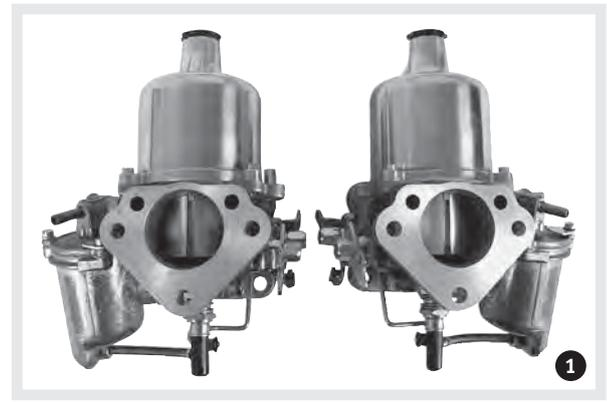

No	Part No	Description	Qty	Notes
1	213933	SU Carburetors HS6 type - new items	1	European specification vehicles - carburettor no. AUD209
1	460218	SU Carburetors HS6 type - exchange	1	
1	304370	SU Carburetors HS6 type - new items	1	USA specification vehicles - carburettor no. AUD284
1	460219	SU Carburetors HS6 type - exchange	1	
2	2424	Air filter element - oval	2	Air filter to carburettor
3	21444	Sticker on air filter.	2	
4	26515	Bolt	4	
5	212193	Plain washer	4	
6	5528	Gasket	2	
7	212194	Spring washer	4	
8	2303	Nut	4	
9	5099	Gasket	4	
10	326159	Spacer block	2	
11	7293	Stud	8	
12	212194	Spring washer	8	
13	2303	Nut	8	

Elora Jet gauge

for carburettor tuning. 0.45 to 1.5 mm diameter.
 Polished, with precision needle gauges
 Part no.205345

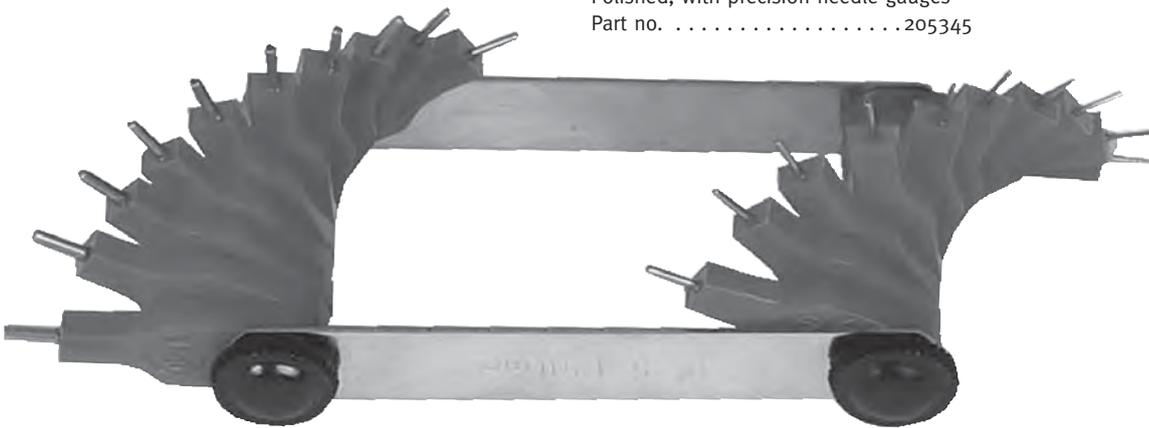

4 Catalogues, you must have:

- Oils and lubricants
- Tuning and more
- Accessories
- Tools



Order online: www.Limora.com • www.scparts.co.uk

6.11

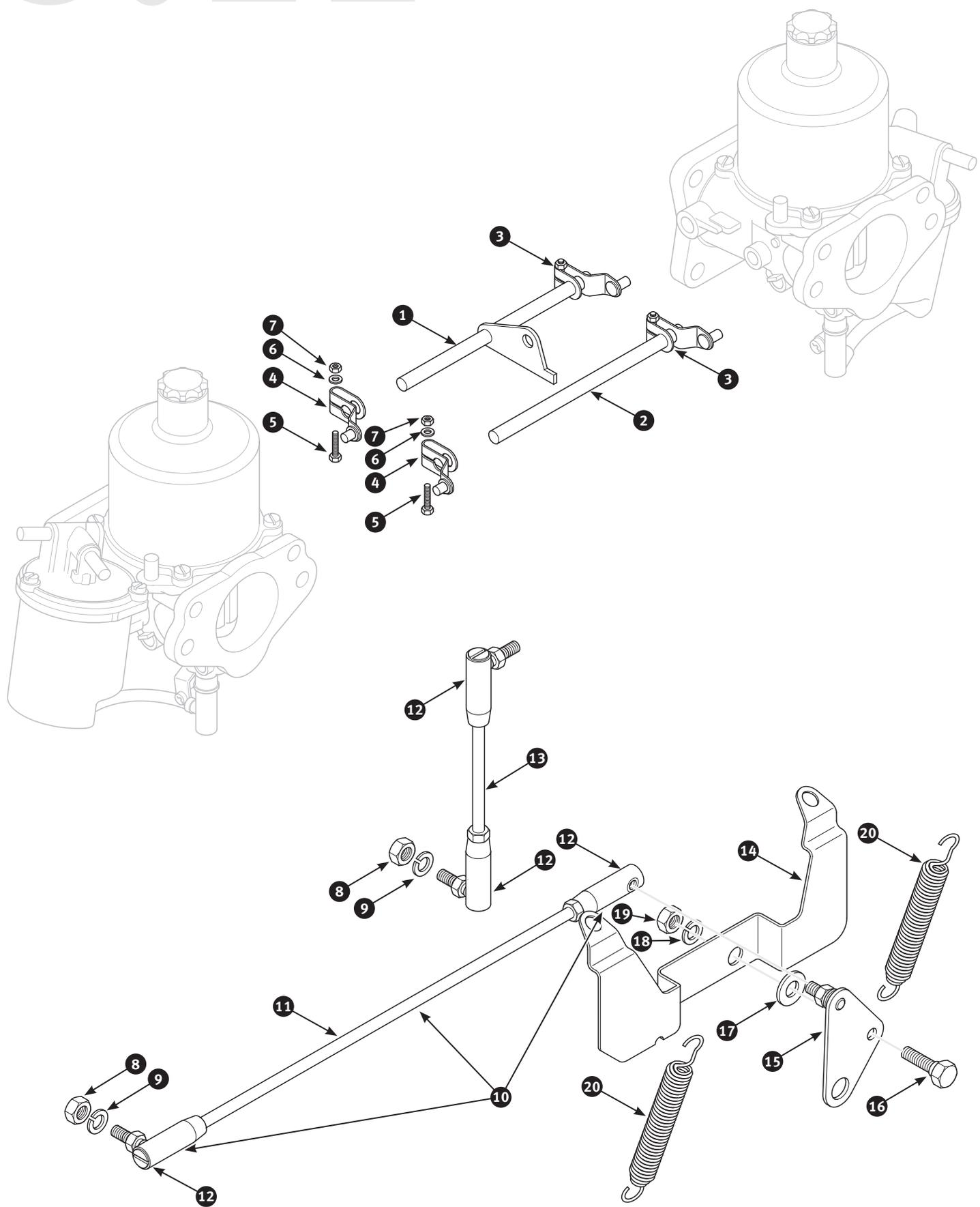

No	Part No	Description	Qty	Notes
1	300692	Coupling shaft between throttle spindles	1	
2	303915	Coupling shaft choke lever	1	
3	1477	Lost motion lever front carburettor	2	
4	1476	Lost motion lever rear carburettor	2	
5	212883	Screw	4	
6	212189	Plain washer	4	
7	6308	Nut	4	
8	7656	Nut	4	
9	212192	Spring washer	4	
10	9908	Connecting rod throttle linkage - with joints assembly	1	
11	18046	Connecting rod throttle linkage - without joints	1	
12	25367	Joint	4	
13	337519	Throttle linkage to connecting rod	1	
14	290237	Bracket throttle return spring	1	
15	9597	Sector throttle linkage	1	
16	9753	Pivot bolt	1	
17	212193	Plain washer	1	
18	212194	Spring washer	1	
19	2303	Nut	1	
20	1980	Return spring throttle linkage	2	



Gunson's Carburettor balancer
 for SU and Zenith carburettors etc.-
 plastic type
 Part no.25749

No	Part No	Description	Qty	Notes
1	21455	Sundries kit throttle linkage	2	
2	10741	Screw main jet to choke lever.	2	} Part of our sundries kit 21455 (ill. 1)
3	1795	Adjusting screw fast idle	2	
4	1789	Spring fast idle	2	
5	1449	Locking washer	2	
6	20105	Steel bush throttle spindle	4	
7	25670	Return springs rear carburettor - supplied in pairs	1	} For bodies with worn cast in bushes
7	25669	Return springs front carburettor - supplied in pairs.	1	
8	448758	Return spring throttle shaft - rear carburettor	1	} Contains throttle spindle and choke lever return springs (ill. 8 and 20)
8	18304	Return spring throttle shaft - front carburettor	1	
9	1420	Screw throttle disc retaining.	4	} Part of our sundries kit 2731 (ill. 19)
10	1119	Throttle disc	2	
10	3185	Throttle disc	2	} European specification vehicles - carburettor no. AUD209
				} USA specification vehicles - carburettor no. AUD284
11	2287	Throttle spindle standard size.	2	
11	21456	Throttle spindle 0.010" oversize	2	
12	323998	Hand reamer for 5/16" throttle spindles	1	} With standard size. Lengths: 115 mm
12	23031	Hand reamer for 5/16" throttle spindles	1	
13	20661	Tool kit for SU carburettors, including jet linkage spanner.	1	} With 0.010" oversize. Lengths: 235 mm
14	7596	Throttle return lever rear carburettor	1	
14	1778	Throttle return lever front carburettor	1	} Part of our sundries kit 2731 (ill. 19)
15	2306	Brass washer throttle spindle	2	
16	1479	Lost motion lever throttle spindle	2	
17	1794	Lock tab throttle spindle	2	
18	1498	Nut throttle spindle	2	
19	2731	Sundries kit throttle spindle	2	
20	348170	Return spring choke lever - front carburettor	1	
20	448749	Return spring choke lever - rear carburettor.	1	
21	300094	Choke lever rear carburettor	1	} Original type
21	20741	Choke lever front carburettor	1	
21	3091	Choke lever rear carburettor	1	} Replacement - these levers should be fitted only in pairs
21	3033	Choke lever front carburettor	1	
22	10741	Screw main jet to choke lever.	2	
23	1449	Locking washer	2	
24	1797	Bolt starter bar guide - complete kit with sleeve and washers	2	
25	18306	Cam rear carburettor	1	
25	18307	Cam front carburettor.	1	
26	16341	Dashpot damper	2	} European specification vehicles - carburettor no. AUD209
26	16340	Dashpot damper	2	
				} USA specification vehicles - carburettor no. AUD284
27	202111	Fibre washer	2	
28	3573	Screw dash pot cover	6	
29	17353	Suction chamber with piston	2	} European specification vehicles - carburettor no. AUD209
29	300825	Suction chamber with piston	2	
				} USA specification vehicles - carburettor no. AUD284
30	755	Dashpot spring red	2	

6.12

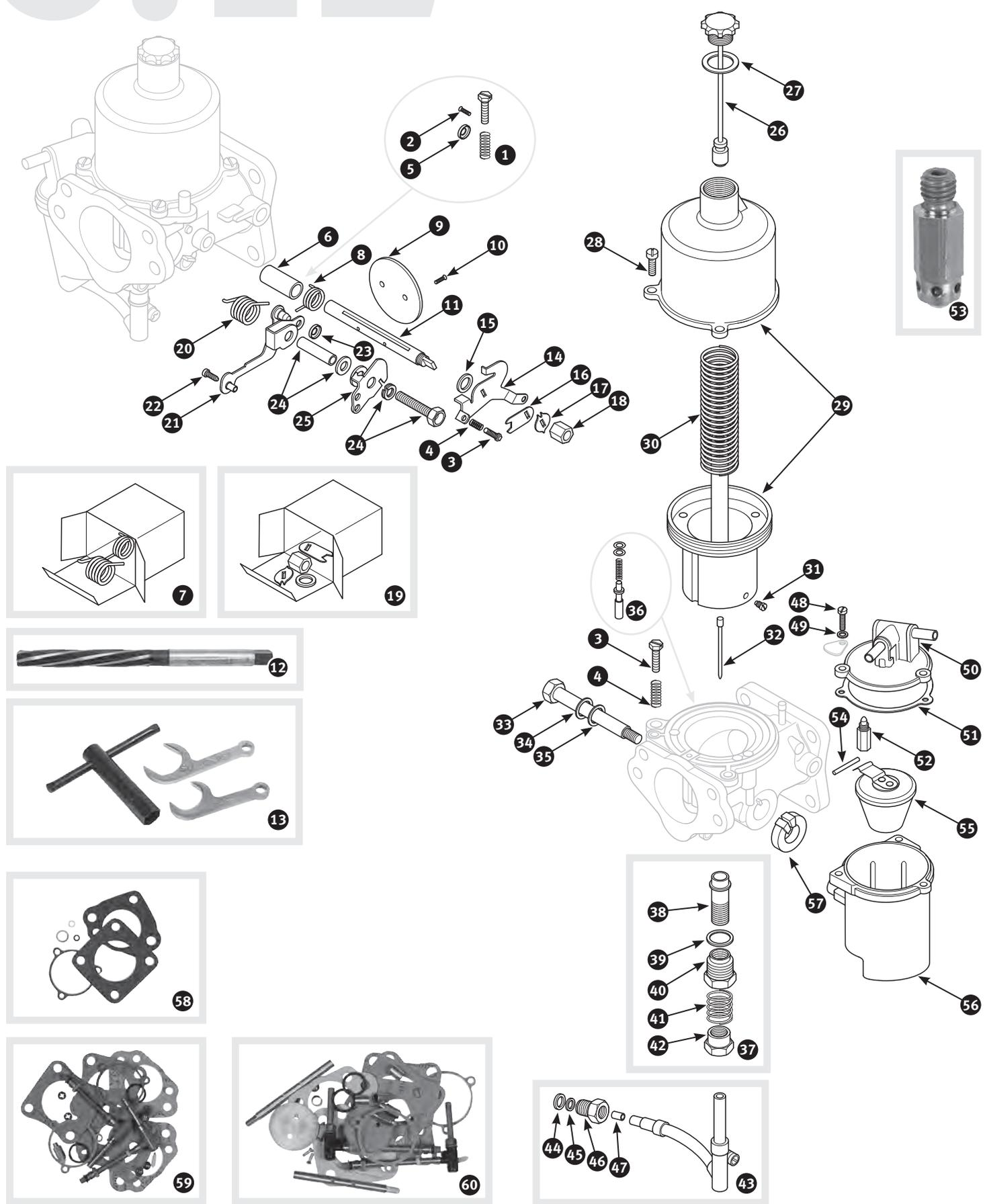

No	Part No	Description	Qty	Notes
31	6408	Locking screw metering needle	2	
32	1497	Metering needle fixed - TW - standard	2	} European specification vehicles - carburettor no. AUD209
32	3283	Metering needle fixed - QW - standard	2	
32	10787	Metering needle fixed - SW - rich	2	} USA specification vehicles - carburettor no. AUD284
32	10786	Metering needle fixed - C1W - weak	2	
33	3563	Bolt float chamber mounting	2	
34	212192	Spring washer	2	
35	212191	Plain washer	2	
36	18196	Lifting pin with spring - carburettor piston	2	} European specification vehicles - carburettor no. AUD209
36	8138	Lifting pin with spring - carburettor piston	2	
37	2735	Jet bearing kit assembly	2	} Part of our jet bearing kit 2735 (ill. 37)
38	220326	Jet bearing	2	
39	6422	Brass washer	2	
40	1478	Locking nut	2	
41	1422	Spring	2	
42	6419	Adjusting nut	2	
43	17243	Main jet rear carburettor	2	} European specification vehicles - carburettor no. AUD209
43	1504	Main jet front carburettor	2	
43	16347	Main jet rear carburettor	2	} USA specification vehicles - carburettor no. AUD284
43	16350	Main jet front carburettor	2	
44	309007	Plain washer main jet	2	} Part of our main jet 17243, 1504, 16347 and 16350 (ill. 43)
45	762	Sealing rubber main jet	2	
46	6440	Steel nut main jet	2	
47	12036	Ferrule main jet	2	
48	3573	Screw float chamber cover	6	
49	212190	Spring washer	6	
50	21443	Lid float chamber - rear carburettor	1	
50	25386	Lid float chamber - front carburettor	1	
51	16355	Gasket float chamber	2	
52	16335	Needle and seat assembly	2	
53	19687	Groser jet	2	} Superior replacement of needle valve and seat
54	1810	Pin on float	2	
55	1118	Float	2	
56	6398	Float chamber	2	
57	18195	Adaptor float chamber - rear carburettor	1	
57	17288	Adaptor float chamber - front carburettor	1	
58	18052	Gasket kit for single carburettor	2	
59	214284	Service kit for single carburettor	1	
60	200213	Rebuilt kit for two carburettors	1	} Comprising service kit 214284 plus throttle discs and throttle spindles

7.1

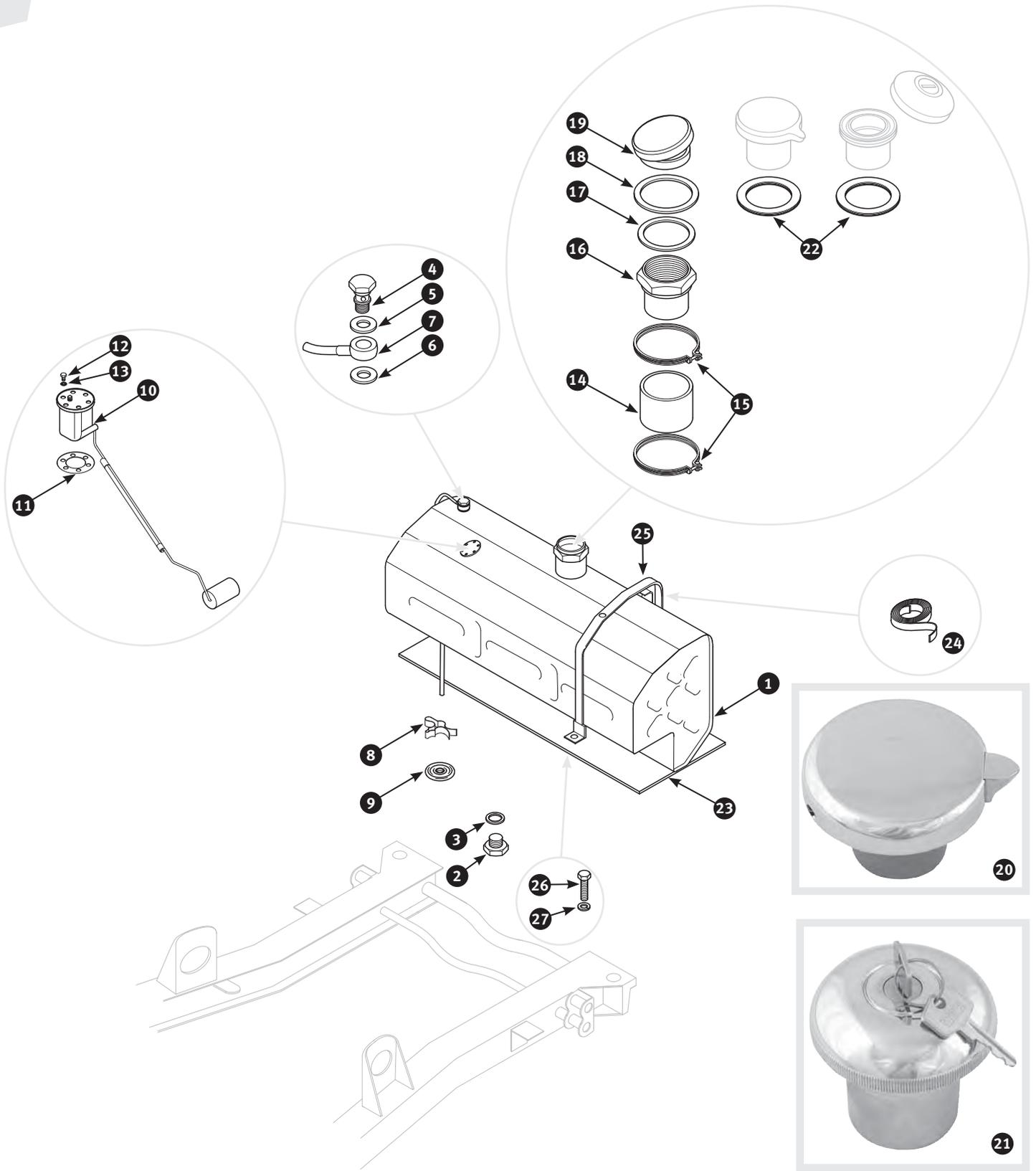

No	Part No	Description	Qty	Notes
1	205386	Fuel tank mild steel - replacement.	1	} Outlet in bottom centre. Needs modification of fuel lines when fitting to TR3A from TS60001 onwards and to TR3B
1	300847	Fuel tank aluminium - replacement	1	
1	14247	Fuel tank stainless steel - replacement	1	
2	218	Blanking plug fuel tank	1	} Original fuel tank only
3	5634	Fibre washer	1	
4	299877	Banjo bolt fuel tank vent pipe	1	
5	3053	Fibre washer - large	1	
6	3807	Fibre washer - small.	1	
7	214845	Pipe fuel tank vent	1	} TR2, TR3, TR3A to TS60000 with original fuel tank only
7	389181	Pipe fuel tank vent	1	} TR3A from TS60001 and TR3B with original fuel tank only
8	3423	Retaining clip fuel tank vent pipe	1	
9	26169	Grommet for 1/2" hole in boot floor	1	
9	22735	Grommet for 1" hole in boot floor.	1	
10	15342	Fuel sender unit	1	
11	8695	Cork seal fuel sender unit.	1	
12	13660	Panhead screw	6	
13	214403	Shakeproof washer	6	
14	9514	Hose filler to fuel tank	1	} Replacement for original hose
15	1555	Hose clip for original hose	2	
15	20318	Hose clip for replacement hose 9514.	2	
16	338171	Filler neck fuel tank - for screw type filler cap	1	
17	374179	Fibre washer	1	
18	300362	Escutcheon	1	
19	2228	Fuel filler cap original screwed type.	1	
20	4466	Fuel filler cap with tube extension - non locking.	1	} Replacement - when fitting these caps the filler neck 338171 (ill. 16) is not needed anymore
21	401	Fuel filler cap with tube extension - locking	1	
22	447	Grommet through rear deck	1	For filler caps 4466 and 401
23	20579	Felt strip tank to body	2	
24	20578	Felt strip tank strap retaining	2	
25	299874	Retaining strap fuel tank	2	} TR2
25	215851	Retaining strap fuel tank	2	
25	219424	Retaining strap fuel tank - new item	1	} TR3
25	299875	Retaining strap fuel tank - used item.	2	
25	461535	Retaining strap fuel tank - new item	2	} TR3A to TS60000
25	212467	Retaining strap fuel tank - used item.	2	
26	213886	Screw fuel tank retaining - length: 3/4"	2	} TR3A from TS60001, TR3B
26	13111	Screw fuel tank retaining - length: 2"	2	
27	2051	Spring washer	4	

Order free of charge:

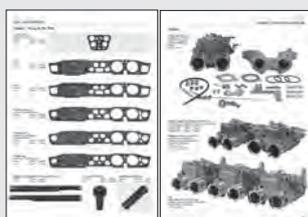

Tuning catalogue

Order free of charge:



Tools catalogue

7.2

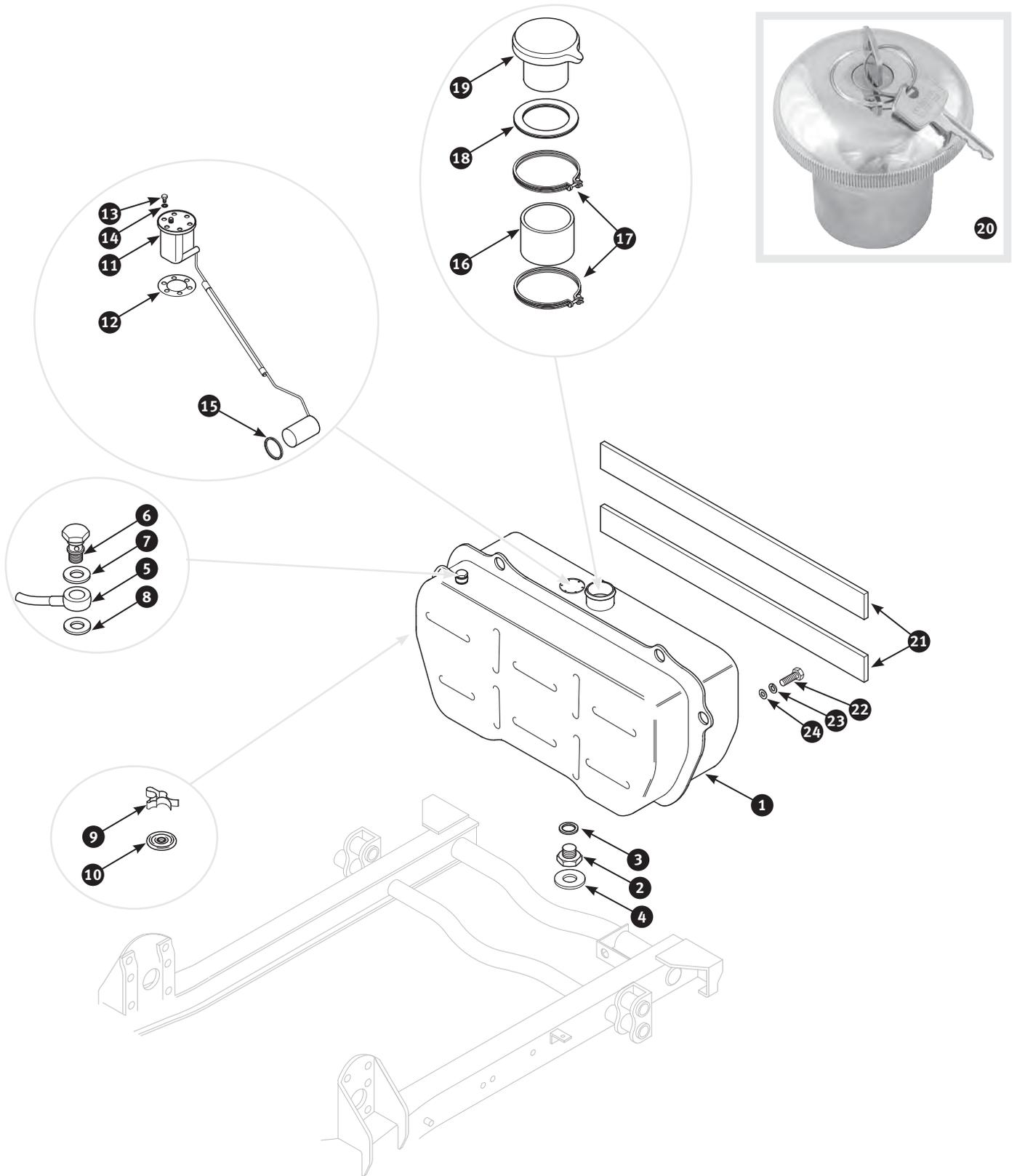

No	Part No	Description	Qty	Notes
1	298318	Fuel tank mild steel	1	
1	19261	Fuel tank aluminium	1	
2	218	Blanking plug fuel tank	1	
3	5634	Fibre washer	1	
4	3327	Pad drain plug to boot floor	1	
5	456329	Pipe fuel tank vent	1	} TR4 to CT19970 with original fuel tank
6	299877	Banjo bolt fuel tank vent pipe	1	
7	3053	Fibre washer - large	1	
8	3807	Fibre washer - small	1	} TR4 to CT19970
9	3423	Retaining clip fuel tank vent pipe	2	
10	26169	Grommet for 1/2" hole in boot floor	1	} TR4 to CT11663
10	22735	Grommet for 1" hole in boot floor	1	
11	20576	Smiths Fuel sender unit exchange - serial no. TF1002/097	1	} TR4 from CT11664 to CT19970
11	20577	Smiths Fuel sender unit exchange - serial no. TF1002/500	1	
11	467477	Fuel sender unit replacement in the original classic look	1	
11	2093	Fuel sender unit replacement	1	} May replace original Smiths fuel sender units 20576 and 20577
12	8695	Cork seal fuel sender unit	1	
13	13660	Panhead screw	6	
14	11440	Fibre washer	6	
15	20700	Rubber ring fuel sender unit	1	} TR4A
16	9514	Hose filler to fuel tank	1	
17	1555	Hose clip for original hose	2	} Replacement for original hose
17	20318	Hose clip for replacement hose 9514	2	
18	447	Grommet filler cap extension through rear deck	1	} Alternatives
19	4466	Fuel filler cap with tube extension - non locking	1	
20	401	Fuel filler cap with tube extension - locking	1	
21	20579	Felt strip tank to body	2	
22	3072	Screw fuel tank retaining	6	
23	212192	Spring washer	6	
24	2831	Plain washer	6	



Fertan fuel tank sealant ,Tapox'
 2-part epoxy fuel tank sealing,
 Tapox is the best preventive and remedial measure as spezial 2-part interior coating, which is designed specifically to be resistant to fuel and provide a corrosion free tank from steel and aluminium . Tapox is useful at bikes, cars, trucks, boats, lawnmovers, etc and is useful too as final coat for metal. After 72 hours at ca. 20° C and an humidity less 70 % the product create a strong film, resistant against fuel and extremely strong against mechanical abrasion. 500 g.
 Part no. 355707

7.3

Fuel pump and fuel tank

Fuel pipes and fuel pump - TR2, TR3, TR3A and TR3B

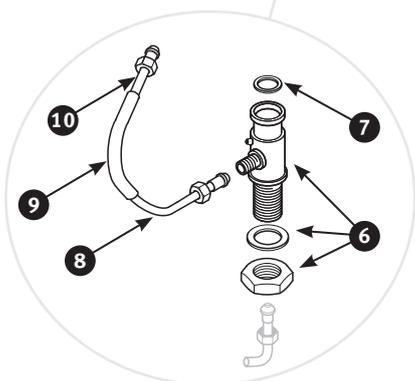
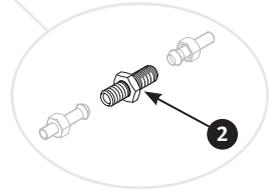
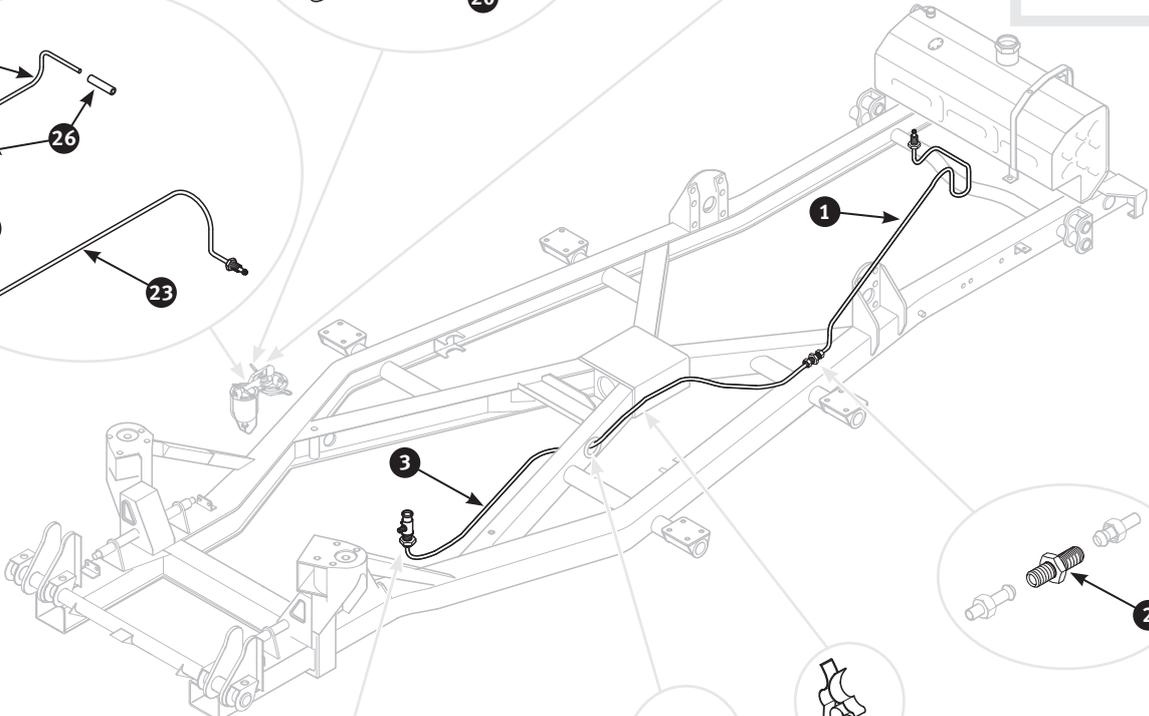
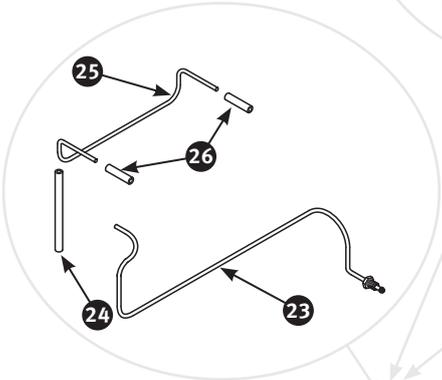
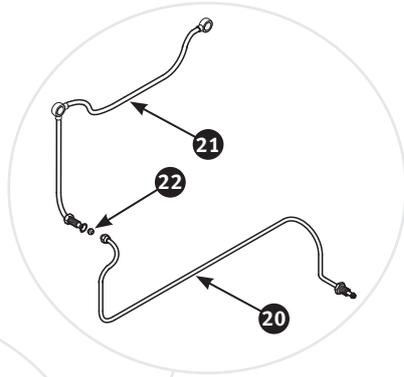
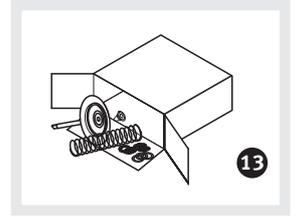
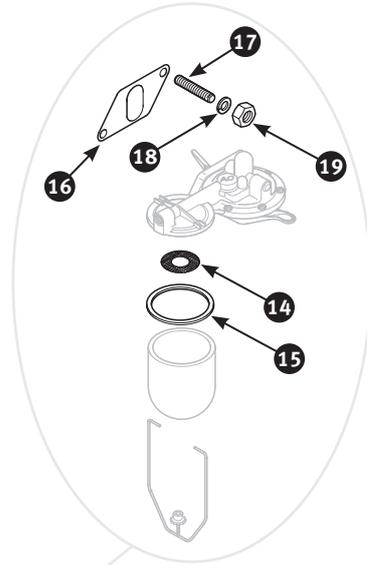

No	Part No	Description	Qty	Notes
1	20696	Fuel pipe fuel tank to union	1	
2	2336	Union adaptor fuel pipe	1	
3	20697	Fuel pipe union adaptor to fuel tap resp. fuel pump	1	
4	3423	Retaining clip fuel pipe to chassis frame	3	
5	13655	Grommet fuel pipe.	2	
6	20587	Fuel tap	1	
7	2346	Cork seal fuel tap	1	
8	21392	Fuel pipe fuel tap to hose	1	
9	5108	Stub pipe between fuel pipes	1	
10	3430	Fuel pipe to fuel pump.	1	
11	13563	Fuel hose aeroquip type - fuel tap to fuel pump.	1	} May replace fuel pipes 21392, 5108 and 3430 (ill.'s 8 to 10)
12	3107	Fuel pump	1	
13	3045	Overhaul kit fuel pump	1	
14	11003	Filter gauze fuel pump	1	
15	17478	Gasket glass bowl to pump	1	
16	9712	Gasket	1	} Fuel pump to cylinder block
17	200361	Stud	2	
18	212194	Spring washer	2	
19	2303	Nut	2	} TR3, TR3A to 1959 - identify by float lid with banjo bolt to adapt fuel pipe
20	19009	Fuel pipe from fuel pump to carburettor hose	1	
21	20266	Fuel hose with banjo bolts - to both carburettors	1	} TR3A from 1959 and TR3B - identify by float lid with push-on to adapt fuel pipe
22	202332	Olive	1	
23	19008	Fuel pipe fuel pump outlet to front carburettor hose	1	} Cars fitted with fuel tap - may replace fuel pipes 20696 and 20697 (ill.'s 1 and 3)
24	5108	Stub pipe fuel pipe to front carburettor	1	
25	20595	Fuel pipe between carburettors	1	} Cars without fuel tap
26	5256	Stub pipe fuel pipe to carburettor	2	
27	469268	Fuel pipe	1	
27	324318	Fuel pipe kit	1	



Fertan primer ,Ferpox'

1-part epoxy primer.
 Quickly drying single-component epoxy ester for metal surfaces as very abrasionproof and heat-resistant coating for surfaces subject to wear and tear. Use in construction of machinery and if besides mechanical resistance temperatur resistance up to + 250° C is also demand. Useful too for restoration of car bodys, boats and many more applications.
 Part no.16798

No	Part No	Description	Qty	Notes
1	3107	Fuel pump	1	
2	11003	Filter gauze fuel pump	1	
3	17478	Gasket glass bowl to pump	1	
4	9712	Gasket	1	} Fuel pump to cylinder block
5	200361	Stud	2	
6	212194	Spring washer	2	
7	2303	Nut	2	
8	3045	Overhaul kit fuel pump	1	
9	21408	Fuel pipe to fuel tank outlet.	1	
10	5108	Stub pipe between fuel pipes.	2	
11	20697	Fuel pipe intermediate	1	
12	3430	Fuel pipe to fuel pump.	1	
13	19008	Fuel pipe fuel pump outlet to hose	1	} Identify by 5/16" inner diameter
14	5108	Stub pipe fuel pipe to carburettor.	1	
13	300003	Fuel pipe fuel pump outlet to hose	1	} Identify by 1/4" inner diameter
14	12746	Fuel hose fuel pipe to carburettor.	1	
15	20704	Retaining clip fuel pipe to thermostat housing	1	
16	20705	Insulator	1	
17	9748	Retaining clip fuel pipe to hose bracket.	1	
18	3423	Retaining clip fuel pipe to chassis frame	4	
19	13655	Grommet fuel pipe.	2	
20	20595	Fuel pipe between carburettors.	1	} TR4 with SU-H6 carburettors
21	5256	Stub pipe fuel pipe to carburettor.	2	
22	294504	Fuel pipe between carburettors.	1	} TR4 with Zenith Stromberg 175CD carburettors
23	5108	Stub pipe fuel pipe to carburettors	2	
24	12555	Fuel pipe kit	1	} TR4 with SU-H6 carburettors
24	324320	Fuel pipe kit	1	

Rust converter
fuel tank, 250 ml
Part no. 356098



Fuel tank sealant 500 ml
Part no. 14198



No	Part No	Description	Qty	Notes
1	3107	Fuel pump	1	
2	11003	Filter gauze fuel pump	1	
3	17478	Gasket glass bowl to pump	1	
4	9712	Gasket	1	} Fuel pump to cylinder block
5	200361	Stud	2	
6	212194	Spring washer	2	
7	2303	Nut	2	
8	3045	Overhaul kit fuel pump	1	
9	300707	Fuel pipe to fuel tank outlet	1	} Early models
10	463535	Fuel pipe intermediate	1	
9	300691	Fuel pipe to fuel tank outlet	1	} Late models
10	21271	Fuel pipe intermediate	1	
11	3430	Fuel pipe to fuel pump - length: 7.7/8"	1	
12	5108	Stub pipe between fuel pipes	3	
13	19008	Fuel pipe fuel pump outlet to hose	1	} Identify by 5/16" inner diameter
14	5108	Stub pipe fuel pipe to carburettor	1	
13	300003	Fuel pipe fuel pump outlet to hose	1	} Identify by 1/4" inner diameter
14	12746	Fuel hose fuel pipe to carburettor	1	
15	20704	Retaining clip fuel pipe to thermostat housing	1	
16	20705	Insulator	1	
17	9748	Retaining clip fuel pipe to hose bracket	1	
18	13655	Grommet fuel pipe	3	
19	3423	Retaining clip fuel pipe to chassis frame	4	
20	2745	Retaining clip fuel pipe	1	
20	13619	Retaining clip fuel pipe	1	} alternative
21	294504	Fuel pipe between carburettors	1	} TR4A with Zenith Stromberg 175CD carburettors
22	5108	Stub pipe fuel pipe to carburettors	2	
23	20698	Fuel pipe between carburettors	1	} TR4A with SU-HS6 carburettors
24	5256	Stub pipe fuel pipe to carburettor	2	
25	324320	Fuel pipe kit	1	} TR4A with Zenith Stromberg 175CD carburettors
25	324319	Fuel pipe kit	1	} TR4A with SU-HS6 carburettors



Fertan Rust converter ,Fedox'
 Fedox is specially developed to remove all rust layers from steel, e.g. fuel tanks, bolts, screws etc. It uncovers the bare metal from all layers of oxide. 1000 ml.
 Part no.245639

8.1

Front suspension

Shock absorber and coil spring - TR2 to TR4

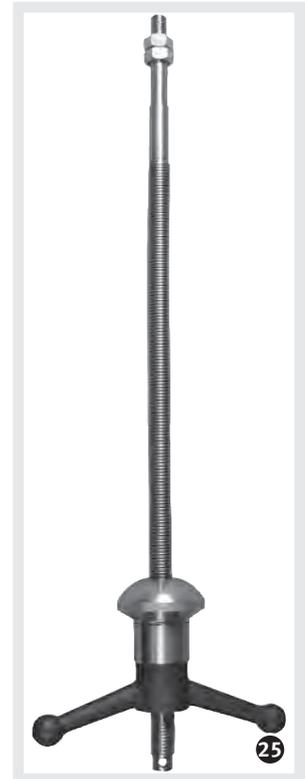
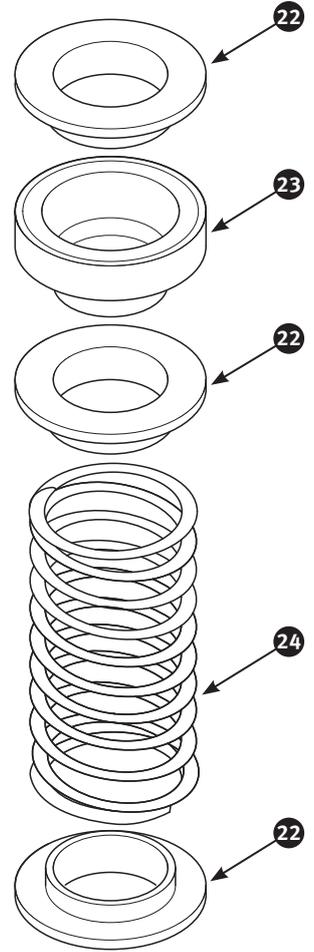
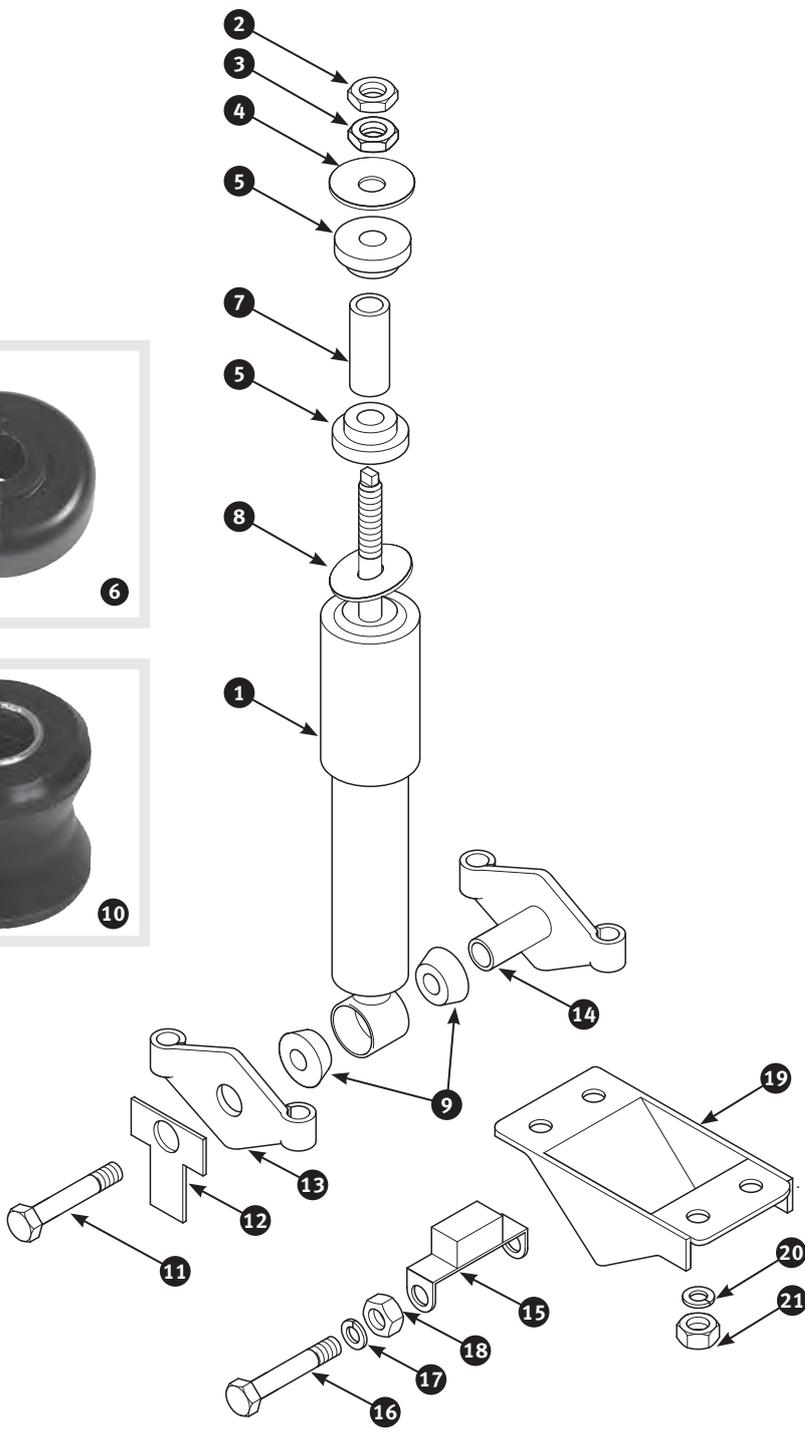

No	Part No	Description	Qty	Notes
1	4746	Shock absorber	2	} Please find Koni and Gaz shock absorber in chapter 21.15
2	7741	Nut	2	
3	3073	Nut	2	
4	21255	Cup washer	2	
5	12361	Rubber bush shock absorber upper mounting	4	} Alternatives
6	317093	Polyurethane bush shock absorber upper mounting	4	
7	448735	Distance tube	2	
8	21255	Cup washer	2	
9	203492	Rubber bush shock absorber lower mounting	4	} Alternatives
10	325767	Polyurethane bush shock absorber lower mounting	2	
11	7903	Screw shock absorber retaining	2	
12	20739	Lock plate	2	
13	2961	Bracket shock absorber	2	
14	19321	Bracket shock absorber - variant with pin	2	
15	208	Rebound buffer front suspension	2	
16	7893	Screw rebound buffer retaining	4	
17	212194	Spring washer	4	
18	2303	Nut	4	
19	26158	Bracket rebound buffer	2	} TR3A, TR3B and TR4
20	2051	Spring washer	8	
21	3073	Nut	8	
22	192	Rubber pad coil spring	6	} TR2 to TR3B, TR4 to CT29983
22	192	Rubber pad coil spring	4	
23	19115	Spacer coil spring	2	} TR2 to TR3B, TR4 to CT29983
24	101	Coil spring - free length: 11"	2	
24	21404	Coil spring - free length 9.3/4"	2	} TR2 to TR3B, TR4 to CT29983
24	101	Coil spring - free length: 11"	2	} TR4 from CT29984
25	339126	Coil spring compressor	1	

Ball joint separator
 for swivel pins, track rod ends and more
 Part no. 336182



8.2

Front suspension

Wishbone and anti roll bar - TR2 to TR4

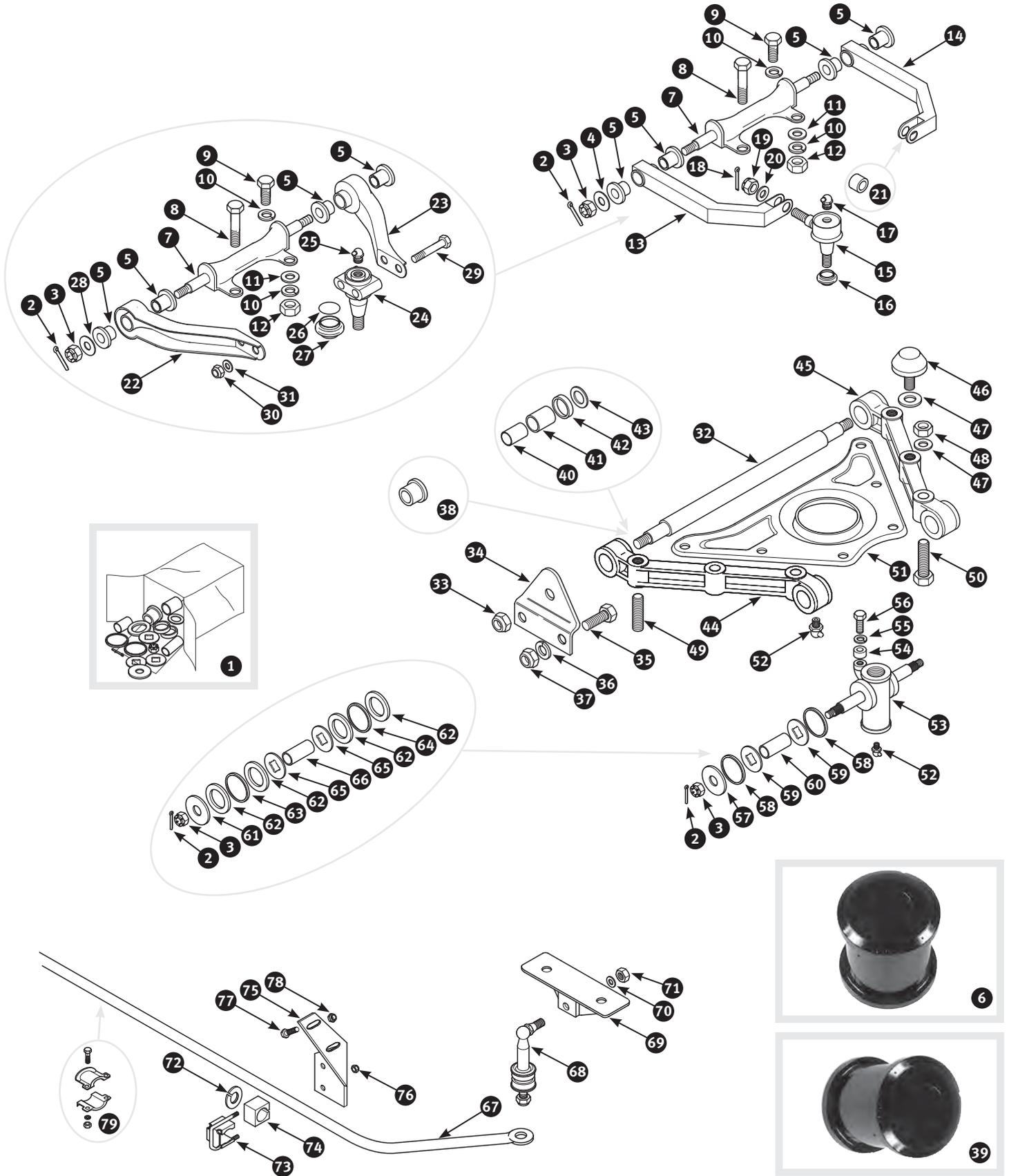

No	Part No	Description	Qty	Notes	
1	19587	Rebuilt kit front suspension - 80 piece	1	} Variant with rubber bushes	
1	326297	Rebuilt kit front suspension - 76 piece	1		
2	10477	Split pin	8	} Variant with polyurethane bushes	
3	4834	Slotted nut	8		
3	2049	Nyloc nut	8	} May replace original slotted nut and split pin	
4	7797	Plain washer	4		
5	201047	Rubber bush upper wishbone	8	} Alternatives	
6	25794	Polyurethane bush upper wishbone	4		
7	315237	Fulcrum pin wishbone	2	} Fulcrum pin retaining	
8	213889	Bolt	4		
9	3800	Screw	4		
10	2051	Spring washer	8		
11	212195	Plain washer	4		
12	3073	Nut	4		
13	296970	Wishbone front	2		
14	300709	Wishbone rear	2		
15	201081	Ball joint	2		
16	16313	Rubber gaiter ball joint	2		} TR2 to TR3B, TR4 with wire wheels to CT6343, TR4 with disc wheels to CT6390
17	5469	Grease nipple ball joint	2		
18	7466	Split pin	2		
19	207919	Slotted nut	2		
20	20036	Plain washer	2		
21	2340	Bush ball joint	2		
22	1673	Wishbone front	2		
23	270	Wishbone rear	2		
24	325502	Ball joint original style	2		
24	1059	Ball joint replacement	2	} TR4 with wire wheels from CT6344, TR4 with disc wheels from CT6391	
25	10938	Grease nipple ball joint	2		
26	215138	Locking ring	2		
27	201003	Gaiter ball joint	2		
28	7797	Plain washer	4		
29	9802	Bolt ball joint retaining	4		
30	2829	Nyloc nut	4		
31	212195	Plain washer	4		
32	2349	Fulcrum pin lower wishbone	2		
33	2303	Nut fulcrum pin to bracket	8		
34	325451	Bracket fulcrum pin	4	} TR2, TR3 to TS9120 - alternatives	
35	212162	Screw bracket to chassis frame	8		
36	212194	Spring washer	8		
37	2049	Nyloc nut	8		
38	201047	Rubber bush lower wishbone	8		
39	25794	Polyurethane bush lower wishbone	4		
40	201056	Steel bush lower wishbone	4		} TR3 from TS9121, TR3A, TR3B und TR4
41	240	Nylon bush lower wishbone	4		
42	201061	Sealing ring lower wishbone	8		
43	201057	Nylon washer lower wishbone	8		} Spring seat to lower wishbone
44	325092	Wishbone front	2		
45	318408	Wishbone rear	2		
46	231	Rebound buffer front suspension	2		
47	10844	Plain washer	12		
48	212110	Nyloc nut	12		
49	9764	Stud	4		
50	213890	Bolt	8		

8.2

Front suspension

Wishbone and anti roll bar - TR2 to TR4

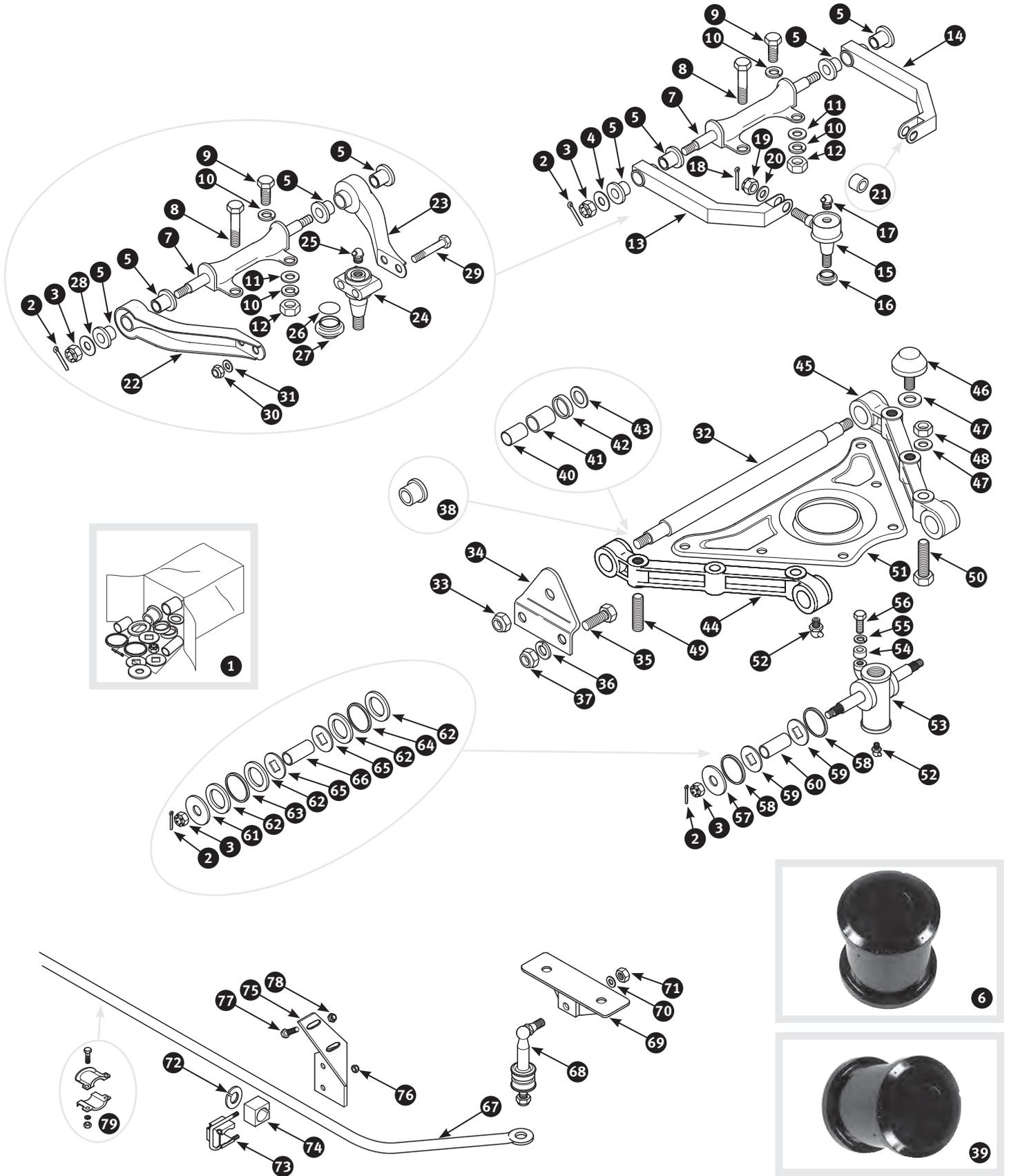

No	Part No	Description	Qty	Notes
51	325452	Spring seat	2	
52	5469	Grease nipple	4	
53	9555	Suspension link trunnion RH and LH - 0° castor	2	} TR2 to TR3B, TR4 with wire wheels to CT6343, TR4 with disc wheels to CT6390
53	1783	Suspension link trunnion RH - 3° castor.	1	
53	1784	Suspension link trunnion LH - 3° castor.	1	} TR4 with wire wheels from CT6344, TR4 with disc wheels from CT6391
54	2057	Stop steering lock	2	
55	212194	Spring washer	2	
56	7893	Screw steering lock stop	2	
57	201060	Plain washer trunnion to wishbone	4	} TR2 to TR3B, TR4 to CT7218
58	201061	Sealing ring trunnion to wishbone.	8	
59	1285	Thrust washer trunnion to wishbone	8	
60	201046	Bush trunnion to wishbone	4	
61	15586	Washer trunnion to wishbone	4	
62	15588	Shim trunnion to wishbone	16	} TR4 from CT7219
63	201061	Sealing ring trunnion to wishbone - outer	4	
64	20788	Sealing ring trunnion to wishbone - inner	4	
65	1285	Thrust washer trunnion to wishbone	8	
66	201046	Bush trunnion to wishbone	4	} Factory option for TR4
67	13163	Anti roll bar - 9/16"	1	
68	17170	Anti roll bar link	2	
69	17169	Bracket anti roll bar link to chassis frame	2	
70	212196	Plain washer	2	
71	2869	Nut	2	
72	17167	Locating washer	2	
73	17166	Mounting strap anti roll bar bush	2	
74	17165	Rubber bush anti roll bar	2	
75	17164	Bracket anti roll bar - LH	1	
75	17163	Bracket anti roll bar - RH	1	
76	7455	Nyloc nut mounting strap to anti roll bar	4	
77	213887	Screw bracket to bumper bracket	4	
78	2829	Nyloc nut	4	
79	6158	Fitting kit anti roll bar	1	

Coil spring compressor
 original Sykes Pickavant
 Part no. 339126

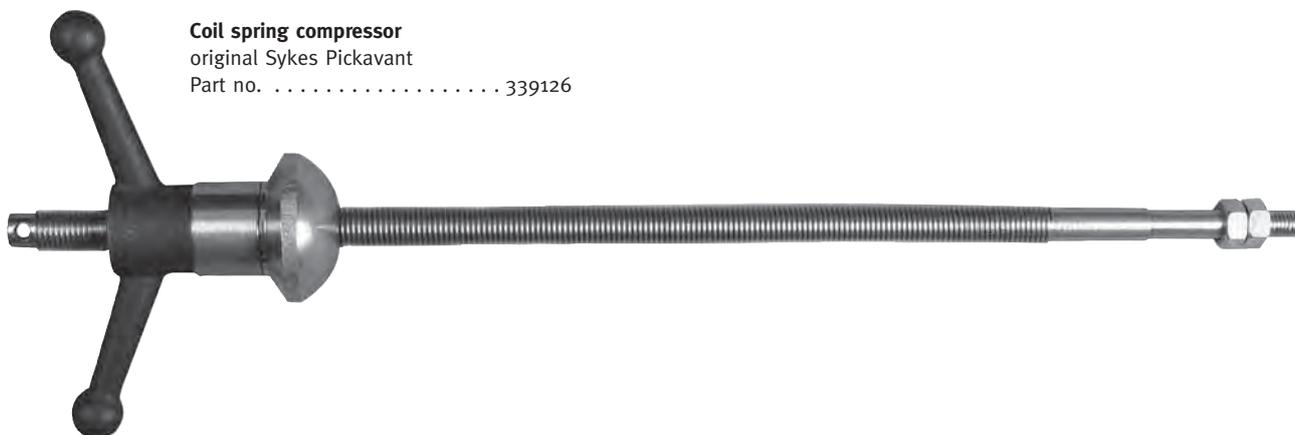

8.3

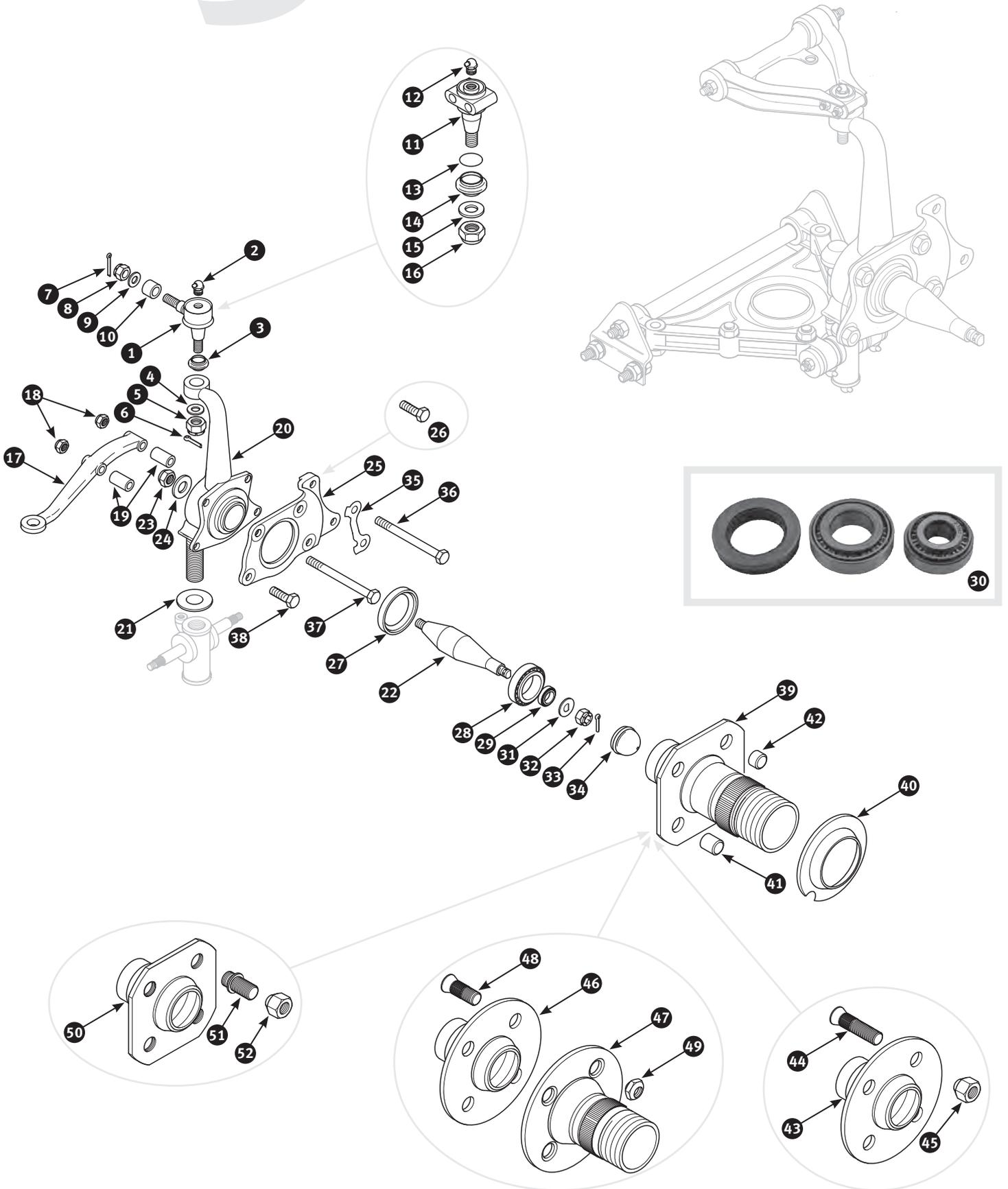



No	Part No	Description	Qty	Notes
1	201081	Ball joint	2	} TR2 to TR3B, TR4 with wire wheels to CT6343, TR4 with disc wheels to CT6390
2	10938	Grease nipple ball joint	2	
3	16313	Rubber gaiter ball joint	2	
4	10483	Plain washer	2	
5	1998	Slotted nut	2	
6	10477	Split pin	2	
7	7466	Split pin	2	
8	207919	Slotted nut	2	
9	20036	Plain washer	2	
10	2340	Bush ball joint	2	
11	325502	Ball joint original style	2	} TR4 with wire wheels from CT6344, TR4 with disc wheels from CT6391
11	1059	Ball joint replacement	2	
12	5469	Grease nipple ball joint	2	
13	215138	Locking ring	2	
14	201003	Gaiter ball joint	2	
15	10483	Plain washer	2	
16	3784	Nyloc nut	2	
17	300633	Steering lever RH.	1	
17	300632	Steering lever LH.	1	
17	300666	Steering lever RH.	1	
17	300667	Steering lever LH.	1	} TR2 to TR3B
17	300673	Steering lever RH.	1	} TR4 with wire wheels to CT6343, TR4 with disc wheels to CT6390
17	300674	Steering lever LH.	1	
17	300681	Steering lever RH.	1	} TR4 with wire wheels from CT6344 to CT16462, TR4 with disc wheels from CT6390 to CT16349
17	300680	Steering lever LH.	1	
18	2829	Nyloc nut steering lever	4	} TR4 with wire wheels from CT16463, TR4 with disc wheels from CT16350
19	5082	Distance tube steering lever	4	
20	336908	Vertical link original style	2	
20	303501	Vertical link for negative camber	2	
21	294084	Seal vertical link to trunnion - original type	2	
21	9727	Seal vertical link to trunnion - improved type	2	
22	9781	Stub axle	2	
23	212113	Nyloc nut stub axle to vertical link	2	
24	10483	Plain washer stub axle to vertical link	2	
25	213745	Backing plate RH brake caliper	1	} TR3 from TS13046, TR3A, TR3B, TR4 with wire wheels to CT4689, TR4 with disc wheels to CT4389
25	300655	Backing plate LH brake caliper	1	
25	2392	Backing plate RH brake caliper	1	} TR4 with wire wheels from CT4690, TR4 with disc wheels CT4388
25	2393	Backing plate LH brake caliper	1	
26	213886	Screw caliper to backing plate - length: 3/4"	2	} TR3 from TS13046, TR3A, TR3B and TR4
26	9849	Bolt caliper to backing plate - length: 1.3/8"	2	
27	1026	Oil seal wheel bearing	2	
28	1016	Wheel bearing inner.	2	
29	1015	Wheel bearing outer	2	
30	16537	Wheel bearing kit	2	} Contains ill.'s 27, 28 and 29

8.3

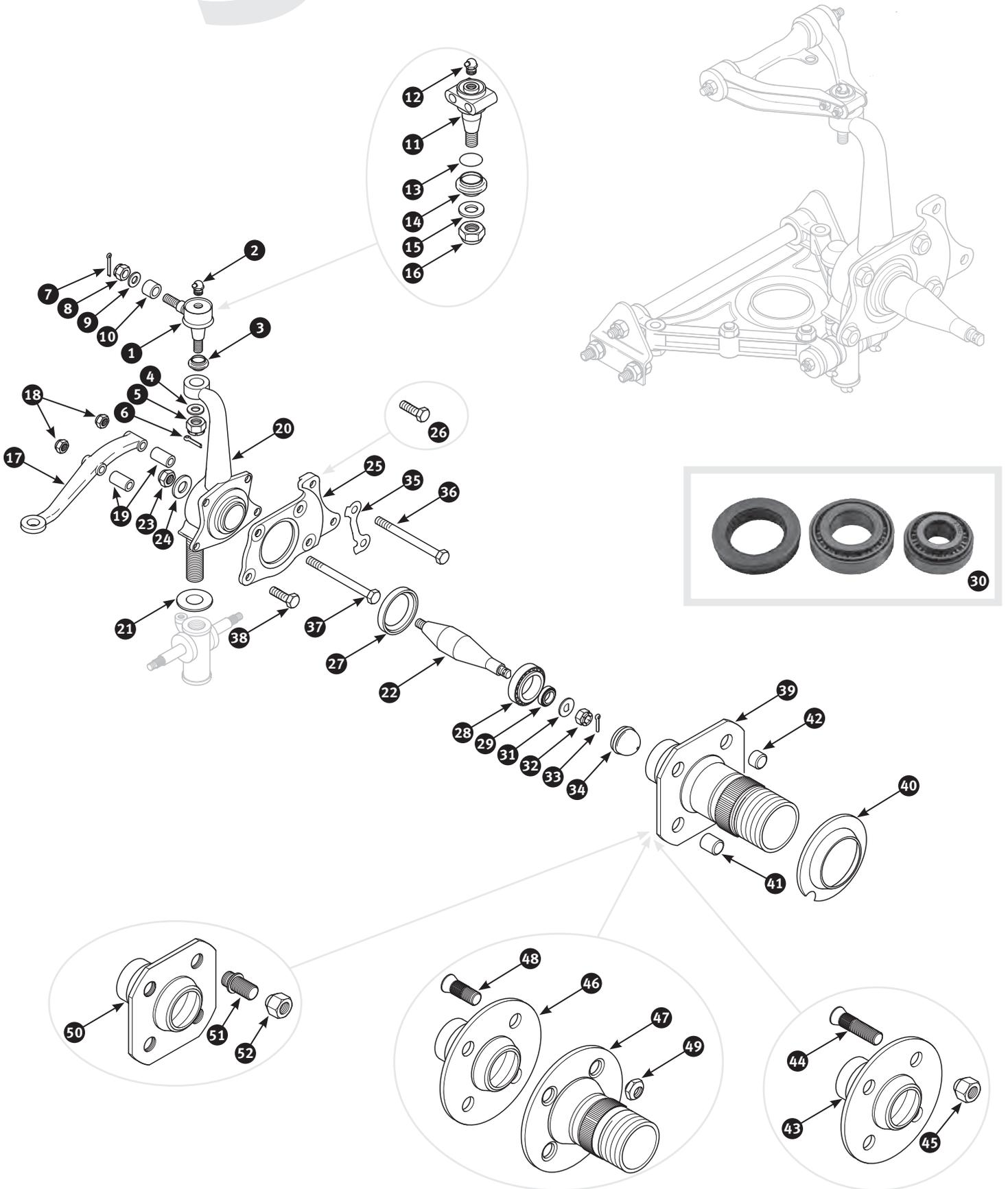

No	Part No	Description	Qty	Notes
31	5042	Washer wheel bearing - ,D' shaped	2	
32	1998	Slotted nut	2	
33	7466	Split pin	2	
34	5041	Grease cap wheel bearing.	2	
35	11285	Lock tab caliper backing plate	4	
36	9802	Bolt steering lever to vertical link - length: 2.3/4"	2	
37	6540	Bolt steering lever to vertical link - length: 3.1/4"	2	} TR2, TR3 to TS13045
37	205324	Bolt steering lever to vertical link - length: 3.1/2"	2	
38	7898	Screw brake drum backing plate to vertical link - length: 5/8"	4	} TR2, TR3 to TS13045
39	20640	Wire wheel hub RH	1	} TR2, TR3 to TS13045 - cars fitted with wire wheels
39	20641	Wire wheel hub LH	1	
40	2003	Distance collar	2	
41	300649	Dowel for collar.	2	
42	290196	Peg brake drum to hub	6	} TR2, TR3 to TS13045 - cars fitted with disc wheels
43	213872	Hub	2	
44	193	Wheel stud	8	} TR2, TR3 to TS13045 - cars fitted with disc wheels
45	4983	Wheel nut	8	
46	250	Hub	2	} TR3 from TS130046, TR3A, TR3B and TR4 - cars fitted with wire wheels
47	342	Wire wheel hub RH	1	
47	343	Wire wheel hub LH	1	
48	1238	Wheel stud	8	
49	1254	Steel nut	8	} TR3 from TS130046, TR3A, TR3B and TR4 - cars fitted with disc wheels
50	250	Hub	2	
51	196	Wheel stud	8	
52	4983	Wheel nut	8	

Order free of charge:



Tools catalogue

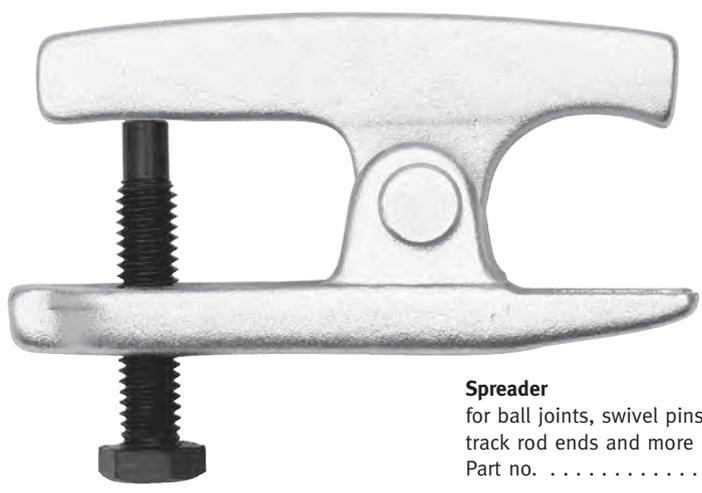

Spreader
for ball joints, swivel pins,
track rod ends and more
Part no. 306854

8.4

Front suspension

Shock absorber and coil spring - TR4A

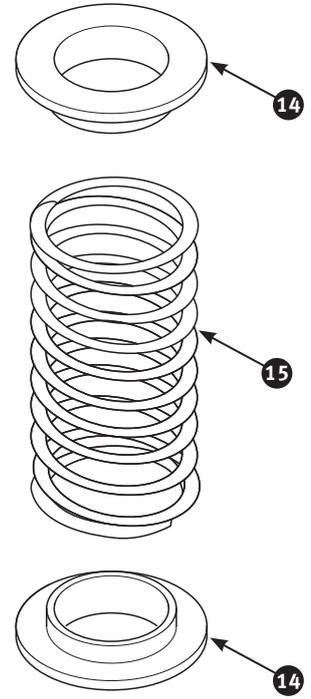
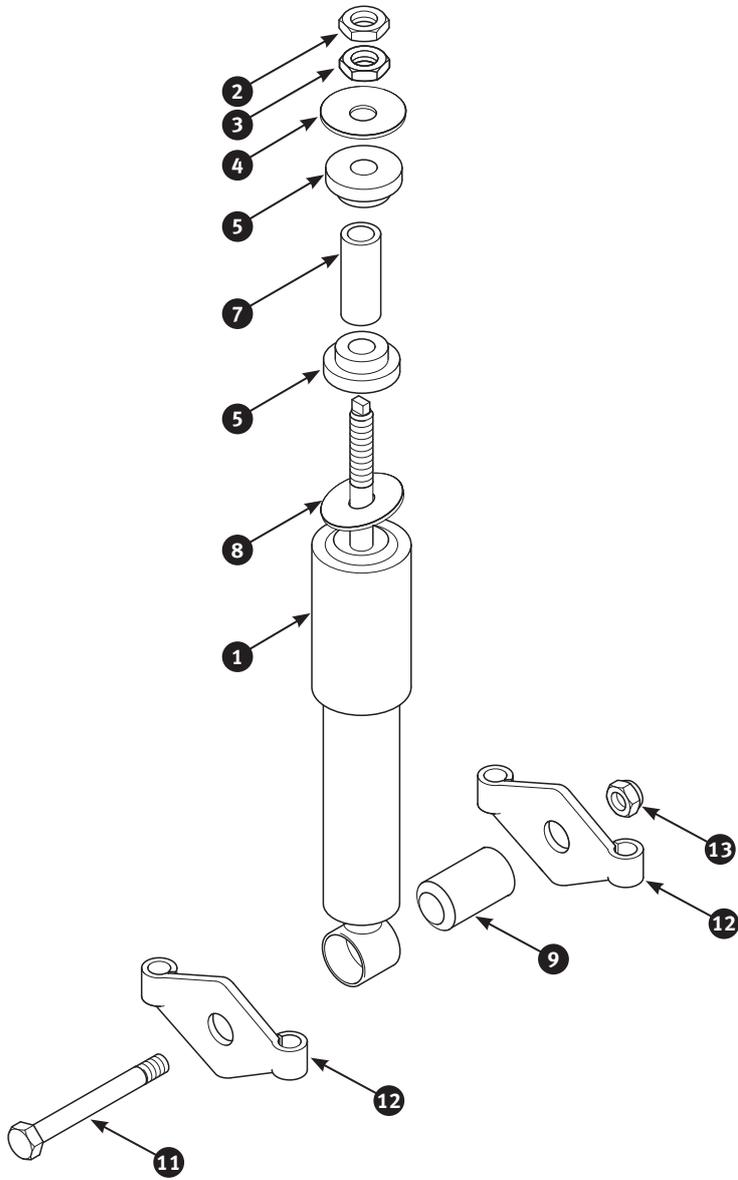

No	Part No	Description	Qty	Notes
1	2891	Shock absorber	2	} Please find Koni and Gaz shock absorber in chapter 21.15
2	7741	Nut	2	
3	3073	Nut	2	
4	9857	Plain washer	2	
5	12361	Rubber bush shock absorber upper mounting	4	} Alternatives
6	317093	Polyurethane bush shock absorber upper mounting	4	
7	448735	Distance tube	2	
8	9857	Plain washer	2	
9	198	Rubber bush shock absorber lower mounting	2	} Alternatives
10	25798	Polyurethane bush shock absorber lower mounting	2	
11	213883	Bolt shock absorber retaining	2	
12	2961	Bracket shock absorber	4	
13	2049	Nyloc nut	2	
14	192	Rubber pad coil spring	4	
15	206	Coil spring	2	
16	311484	Coil spring compressor - supplied in pairs	1	

Order free of charge:

Oils and lubricants catalogue



Penrite Grease
 500 gr, high melt bearing grease
 Part no. 212127



8.5

Front suspension

Wishbone and anti roll bar - TR4A

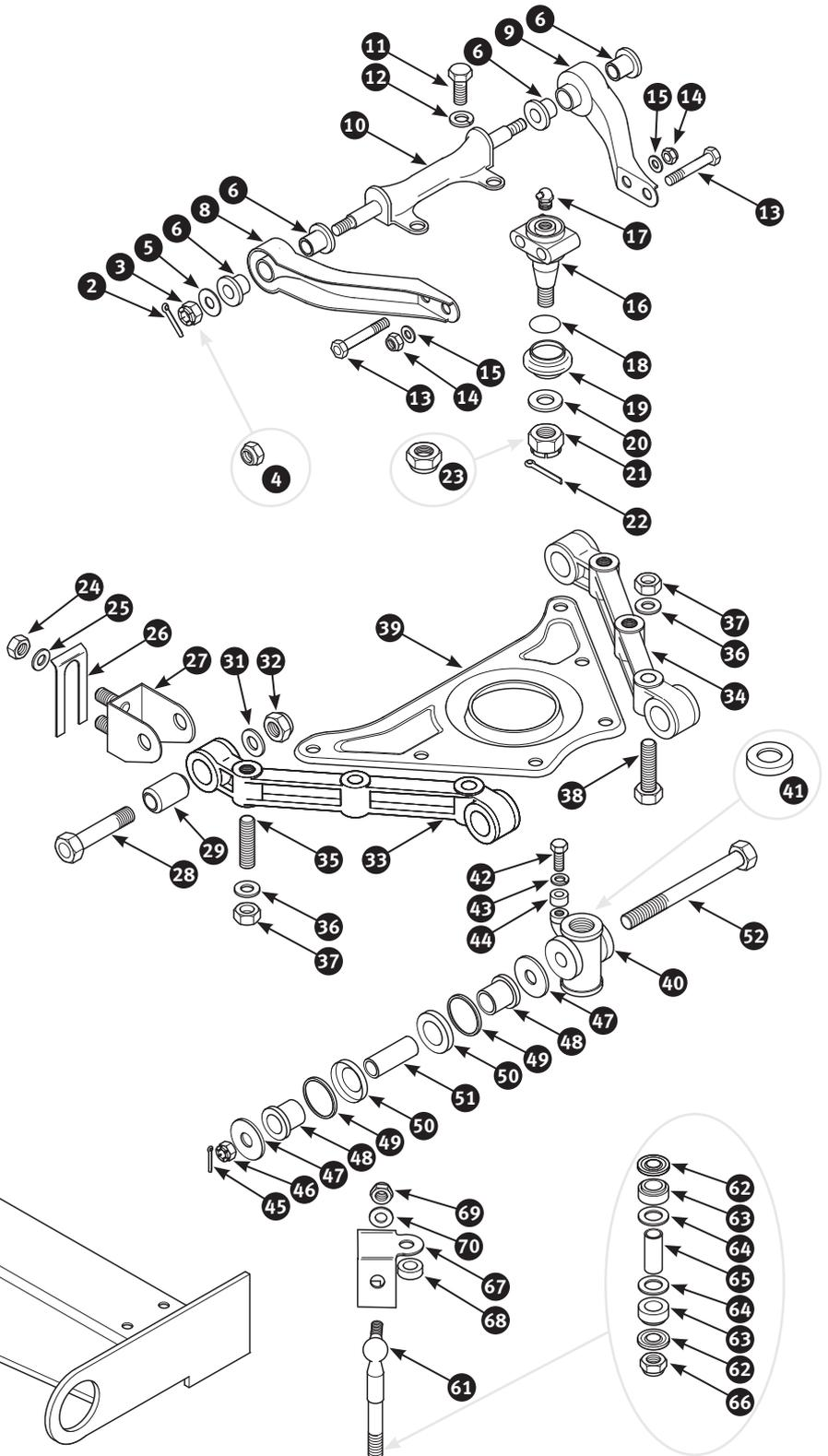
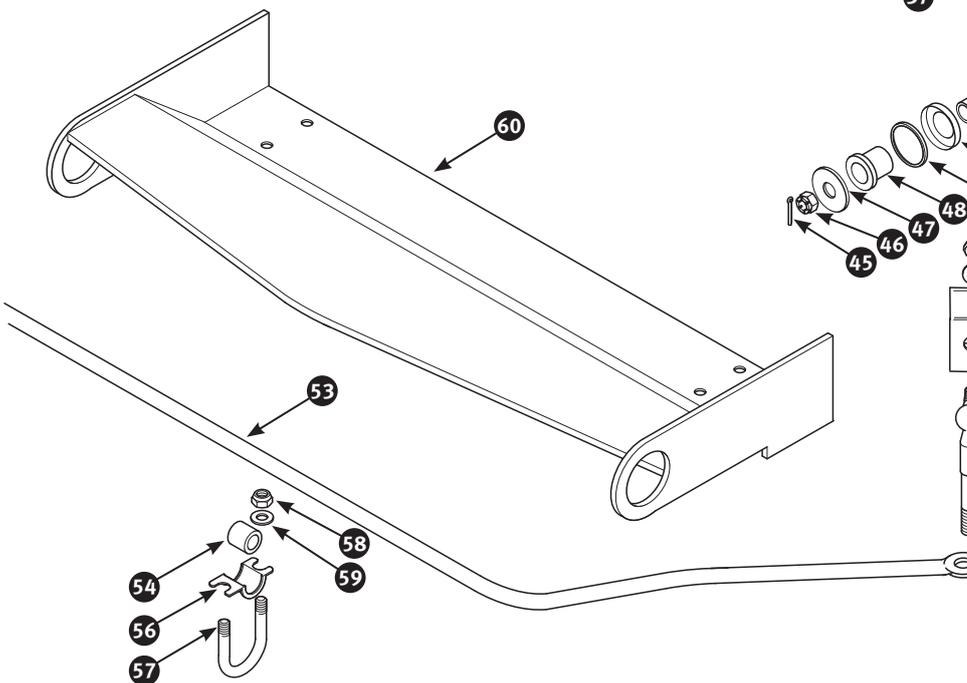
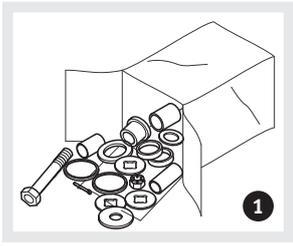



No	Part No	Description	Qty	Notes
1	19586	Rebuilt kit front suspension - variant with rubber bushes	1	
1	339127	Rebuilt kit front suspension - variant with polyurethane bushes.	1	
2	10477	Split pin	4	
3	4834	Slotted nut	4	
4	2049	Nyloc nut	4	} May replace original slotted nut and split pin (ill. 2 and 3)
5	7797	Plain washer	4	
6	201047	Rubber bush upper wishbone	8	} Alternatives
7	25794	Polyurethane bush upper wishbone.	4	
8	1673	Wishbone front	2	
9	270	Wishbone rear.	2	
10	315237	Fulcrum pin wishbone	2	
11	3800	Screw upper fulcrum pin retaining.	4	
12	2051	Spring washer	4	
13	9802	Bolt	4	} Ball joint retaining
14	2829	Nyloc nut	4	
15	212195	Plain washer	4	} Alternatives
16	325502	Ball joint original style.	2	
15	1059	Ball joint replacement	2	
17	10938	Grease nipple	2	
18	215138	Locking ring	2	
19	201003	Gaiter ball joint	2	
20	10483	Plain washer	2	
21	1998	Slotted nut	2	
22	10477	Split pin	2	
23	3784	Nyloc nut	2	} May replace original slotted nut and split pin (ill. 21 and 22)
24	2829	Nyloc nut	8	
25	9671	Plain washer	8	
26	9794	Shim front suspension camber - 0.059"	0	} Quantity as required
27	201078	Bracket wishbone to chassis frame	4	
28	10734	Bolt wishbone to bracket	4	
29	1260	Rubber bush lower wishbone	4	} Alternatives
30	25795	Polyurethane bush lower wishbone	4	
31	212197	Plain washer	4	
32	3784	Nyloc nut	4	
33	9793	Wishbone front	2	
34	9792	Wishbone rear.	2	
35	9764	Stud spring seat to lower wishbone	4	
36	10844	Plain washer	12	
37	2829	Nyloc nut	12	
38	213890	Bolt spring seat to lower wishbone	8	} Cars without anti roll bar
38	213890	Bolt spring seat to lower wishbone - length: 2"	6	
38	9802	Bolt spring seat to lower wishbone - length: 2.3/4"	2	} Cars with anti roll bar
39	293248	Spring seat	2	
40	285	Suspension link trunnion LH - castor: 2° 40 min.	1	
40	284	Suspension link trunnion RH - castor: 2° 40 min	1	
41	9727	Seal vertical link to trunnion.	2	
42	7897	Screw steering lock stop	2	
43	212194	Spring washer	2	
44	10418	Stop steering lock	2	
45	7466	Split pin	2	} Trunnion to wishbone
46	207919	Slotted nut	2	
47	1262	Washer	8	
48	201015	Nylon bush	8	
49	1261	,O' ring	8	
50	2118	Cup washer	8	
51	201069	Steel bush	4	
52	1357	Bolt	2	

8.5

Front suspension

Wishbone and anti roll bar - TR4A

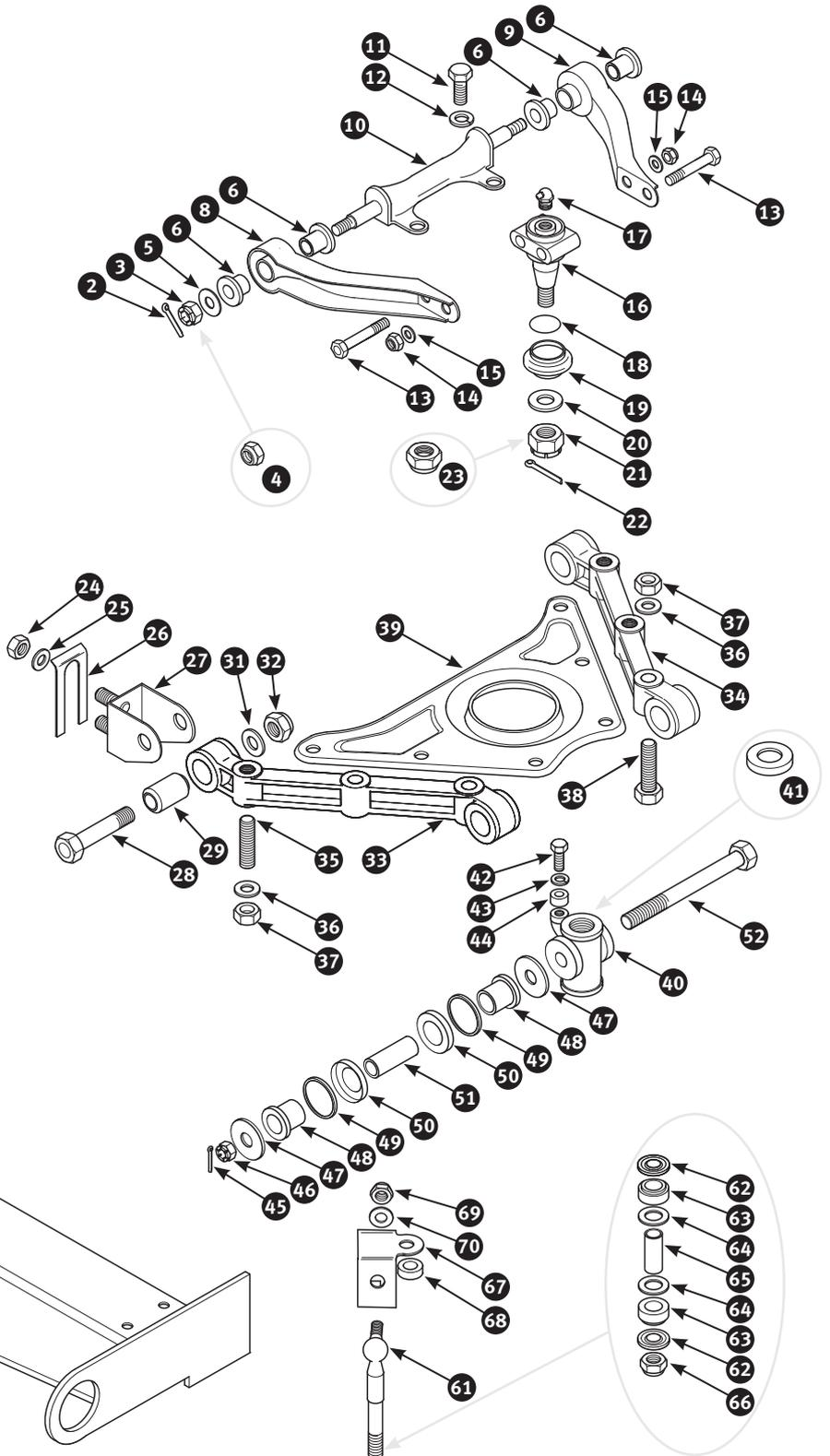
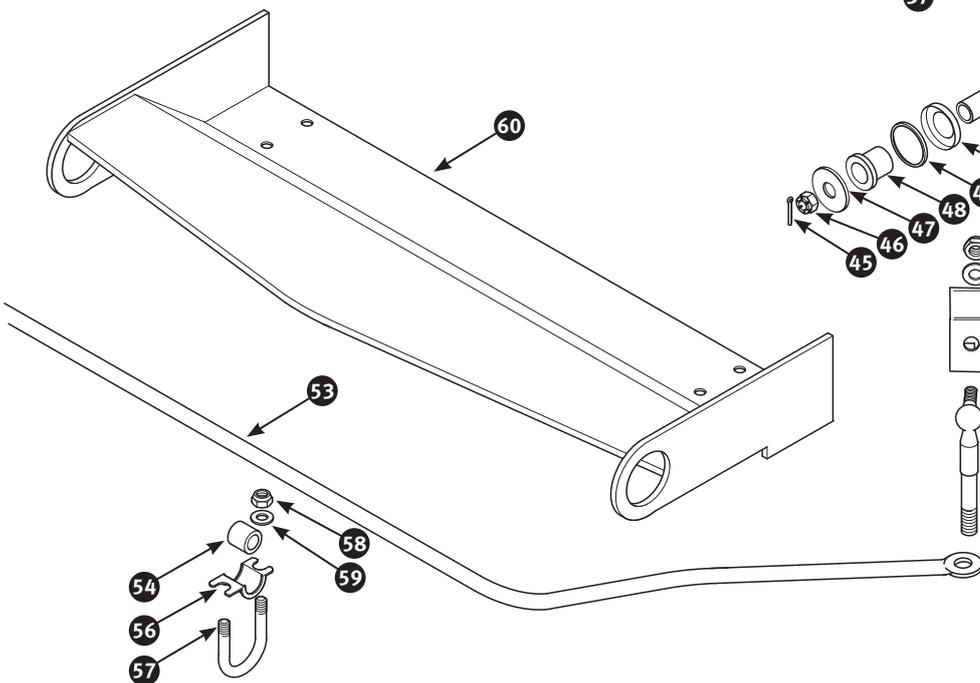
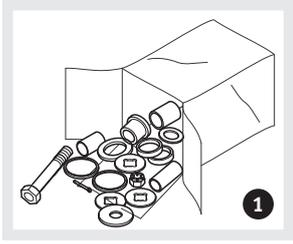

No	Part No	Description	Qty	Notes
53	341	Anti roll bar	1	} The TR6 anti roll bar will fit a TR4A with minimal modification
54	4889	Rubber bush anti roll bar	2	
55	313334	Polyurethane bush anti roll bar	2	
56	9786	Mounting bracket anti roll bar bush.	2	
57	2307	,U' bolt	2	
58	7455	Nyloc nut	4	
59	212193	Plain washer	4	
60	3019	Radiator guard	1	
61	16205	Anti roll bar link assembly	2	
62	1675	Washer anti roll bar link - separately.	2	
63	26702	Rubber bush anti roll bar link - separately.	4	} May replace original rubber bush 26702 (ill. 63)
64	1364	Cup washer anti roll bar link - separately.	4	
65	2973	Distance tube anti roll bar link - separately	2	
66	2829	Nyloc nut anti roll bar link - separately	2	
67	9956	Mounting bracket anti roll bar to chassis frame	2	
68	1212	Spacer mounting bracket	2	
69	7456	Nyloc nut anti roll bar link	2	
70	212196	Plain washer	2	
71	317871	Polyurethane bush anti roll bar link.	4	



Impact wrench
heavy duty quality, max. torque: 280 lb-ft,
operating pressure: 6,2 bar, air consumption: 114 l/min
Part no.343295

8.6

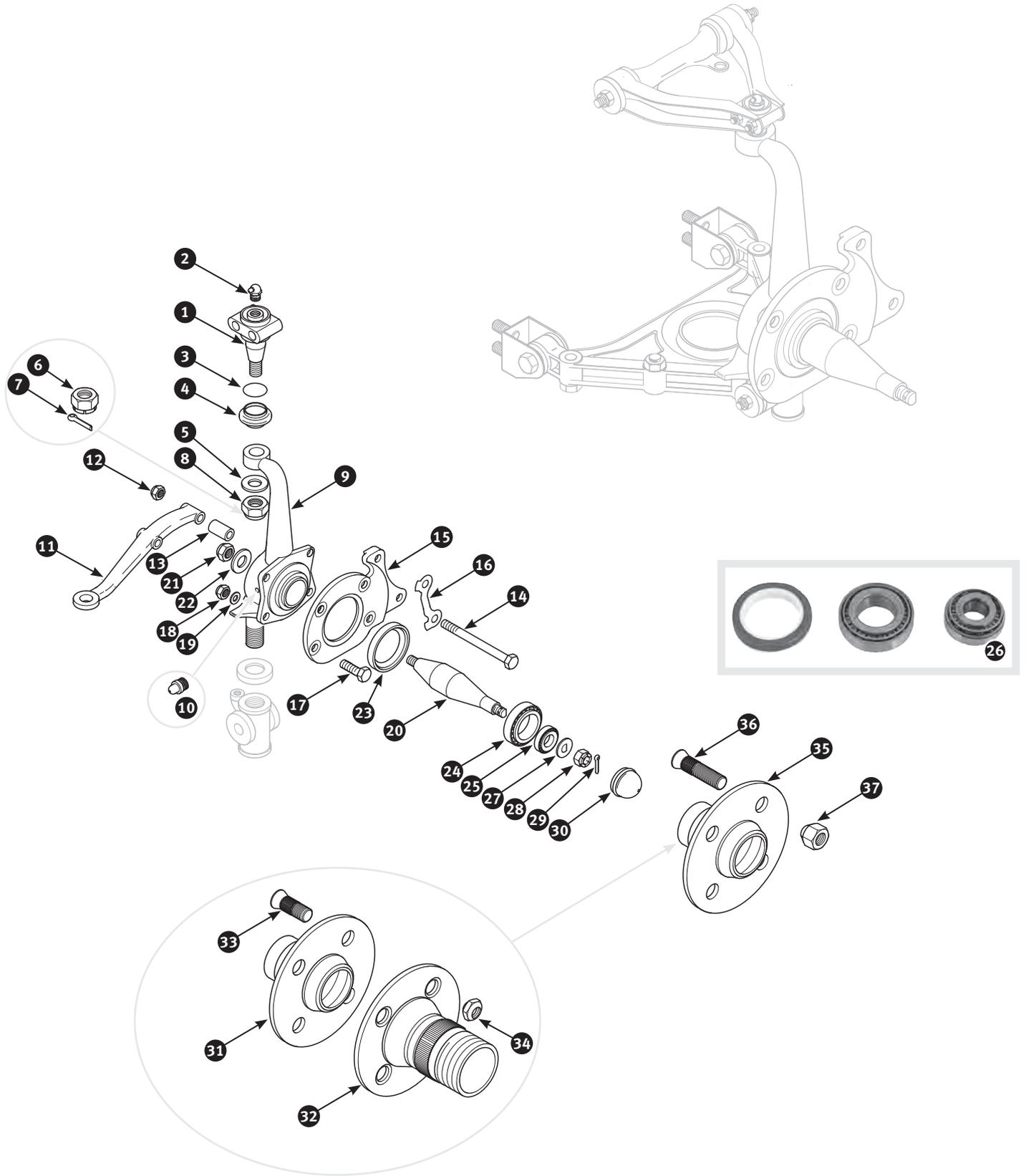

No	Part No	Description	Qty	Notes
1	325502	Ball joint original style	2	} Alternatives
1	1059	Ball joint replacement	2	
2	10938	Grease nipple ball joint	2	
3	215138	Locking ring	2	
4	201003	Gaiter ball joint	2	
5	10483	Plain washer	2	
6	1998	Slotted nut	2	
7	10477	Split pin	2	
8	3784	Nyloc nut	2	} May replace original slotted nut and split pin (ill. 6 and 7)
9	2992	Vertical link RH	1	} Steering lever to vertical link
9	4898	Vertical link LH	1	
10	5469	Grease nipple vertical link	2	
11	9790	Steering lever RH.	1	
11	9791	Steering lever LH.	1	
12	2829	Nyloc nut steering lever	4	
13	5082	Distance tube steering lever	4	
14	213892	Bolt - length: 3"	2	
14	205324	Bolt - length: 3.5"	2	
15	2392	Backing plate RH brake caliper	1	
15	2393	Backing plate LH brake caliper	1	
16	11285	Lock tab caliper backing plate	4	
17	213886	Screw - length: 3/4"	2	
17	6535	Bolt - length: 1.3/8"	2	
18	2829	Nyloc nut	4	
19	10483	Plain washer	4	
20	9781	Stub axle	2	} Stub axle to vertical link
21	212113	Nyloc nut	2	
22	10483	Plain washer	2	
23	1026	Oil seal wheel bearing	2	} Contains ill.'s 23, 24 and 25
24	1016	Wheel bearing inner.	2	
25	1015	Wheel bearing outer	2	
26	1407	Wheel bearing kit	2	
27	5042	Washer ,D' shaped.	2	
28	1998	Slotted nut	2	} Cars fitted with wire wheels
29	7466	Split pin	2	
30	5041	Grease cap wheel bearing.	2	
31	250	Hub	2	
32	342	Wire wheel hub RH	1	
32	343	Wire wheel hub LH	1	
33	1238	Wheel stud	8	
34	1254	Steel nut	8	
35	250	Hub	2	
36	196	Wheel stud	8	
37	4983	Wheel nut	8	} Cars fitted with disc wheels

9.1

Manifold and exhaust

Inlet and exhaust manifold

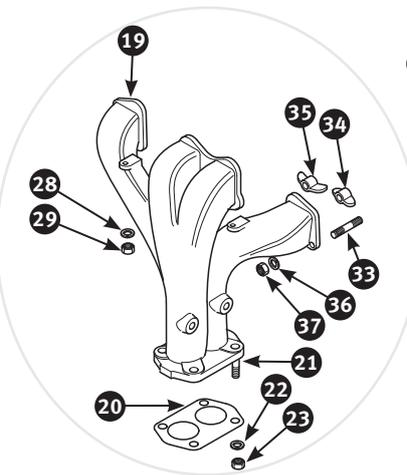
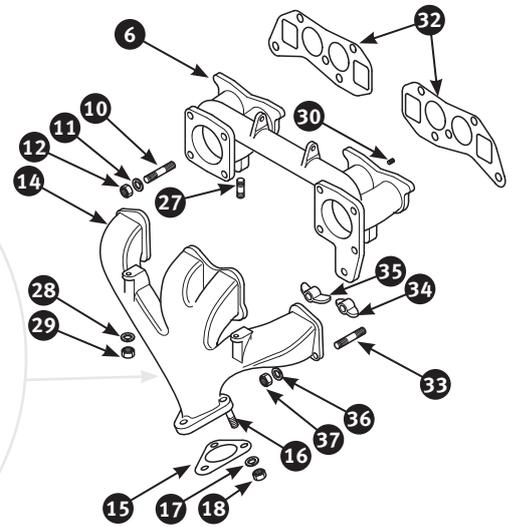
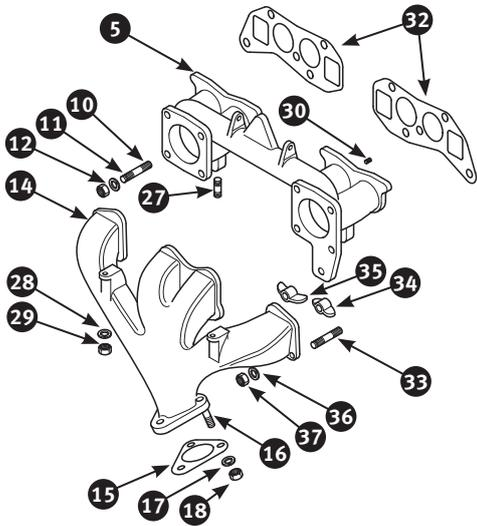
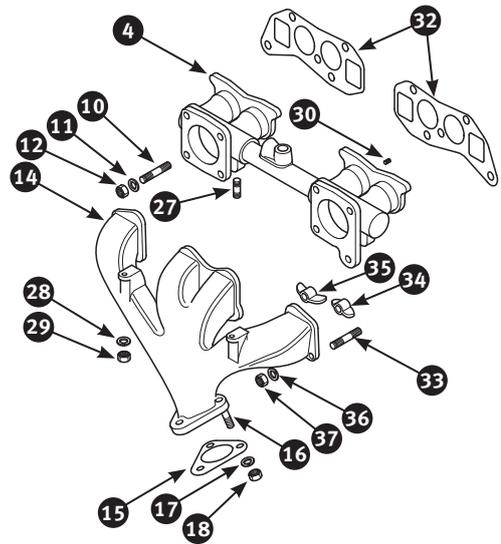
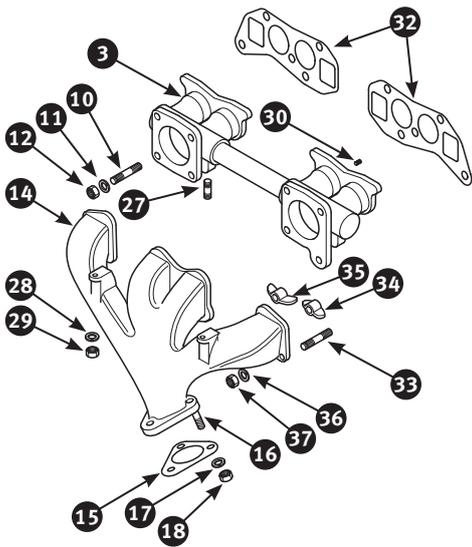
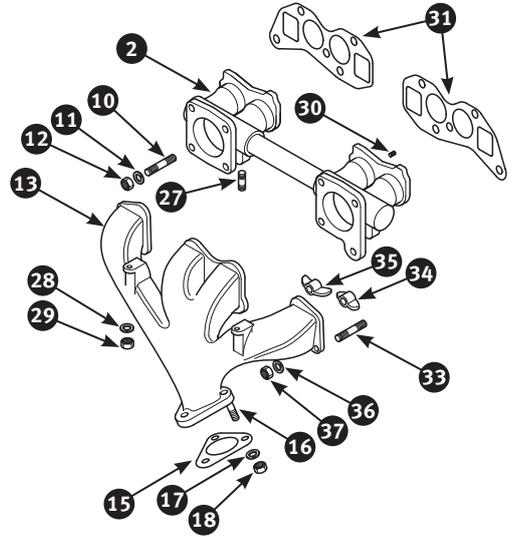
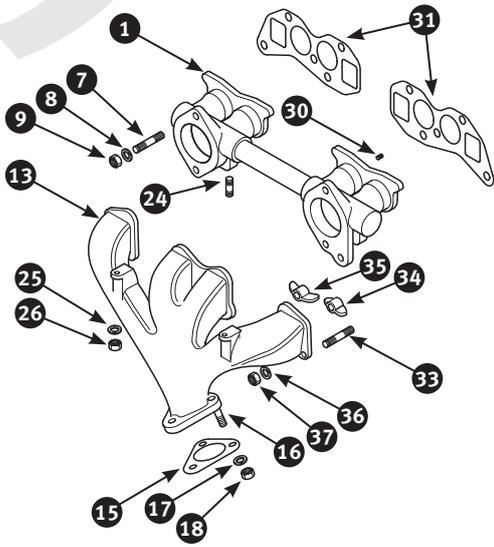

No	Part No	Description	Qty	Notes
1	214521	Inlet manifold for low port cylinder head with SU-H4 carburettors	1	} TR2, TR3 to engine no. TS8996 - identify by 301145 cast on underside of balance tube
2	214522	Inlet manifold for low port cylinder head with SU-H6 carburettors	1	
3	446809	Inlet manifold for high port cylinder head with SU-H6 carburettors - new item	1	} TR3 from engine no. TS13052, TR3A - identify by 302119 cast on underside of balance tube
3	214523	Inlet manifold for high port cylinder head with SU-H6 carburettors - used item	1	
4	214524	Inlet manifold for high port cylinder head with SU-H6 carburettors	1	
5	214525	Inlet manifold for high port cylinder head with SU-HS6 or Zenith Stromberg 175CD carburettors	1	} TR4 from engine no. CT16801 to CT16900 only, and from CT21471 - identify by 305744 cast on underside of balance tube
6	446810	Inlet manifold for high port cylinder head with SU-HS6 or Zenith Stromberg 175CD carburettors	1	
7	2332	Stud carburettor to inlet manifold	4	} TR2, TR3 to engine no. TS8996
8	2051	Spring washer	4	
9	3952	Nut	4	
10	7293	Stud carburettor to inlet manifold	8	} TR3 from engine no. TS8997, TR3A to TR4A
11	212194	Spring washer	8	
12	2303	Nut	8	
13	446812	Exhaust manifold for low port cylinder head - new item	1	} TR2, TR3 to engine no. TS13051
13	214527	Exhaust manifold for low port cylinder head - used item	1	
14	446813	Exhaust manifold for high port cylinder head - new item	1	} TR3 from engine no. TS13052, TR3A and TR4
14	203246	Exhaust manifold for high port cylinder head - used item	1	
15	976	Gasket exhaust manifold to down pipe	1	
16	5040	Stud	3	} TR2 to TR4
17	2051	Spring washer	3	
18	201055	Brass nut	3	
19	214528	Exhaust manifold for high port cylinder head	1	} TR4A
20	977	Gasket exhaust manifold to down pipe	1	
21	2375	Stud	4	
22	2051	Spring washer	4	
23	201055	Brass nut	4	
24	7999	Stud inlet to exhaust manifold	2	} TR2, TR3 to engine no. TS8996
25	212194	Spring washer	2	
26	2303	Nut	2	
27	7293	Stud inlet to exhaust manifold	2	} TR3 from engine no. TS8997, TR3A to TR4A
28	212194	Spring washer	2	
29	2303	Nut	2	
30	4910	Pin inlet manifold to cylinder head	2	} TR2, TR3 to engine no. TS13051
31	2354	Manifold gasket for low port cylinder head	2	
32	201058	Manifold gasket for high port cylinder head	2	} TR3 from engine no. TS13052, TR3A to TR4A
33	2344	Stud length 2.1/16"	4	
33	2357	Stud length 2.3/8"	2	
33	2331	Stud length 1.11/16"	1	
33	2332	Stud length 1.15/16" - cars with lifting eye	1	
33	2331	Stud length 1.11/16" - cars without lifting eye	1	
34	5032	Clamp small	1	
35	5029	Clamp large	2	
36	2051	Spring washer	8	
37	201055	Brass nut	8	

9.2

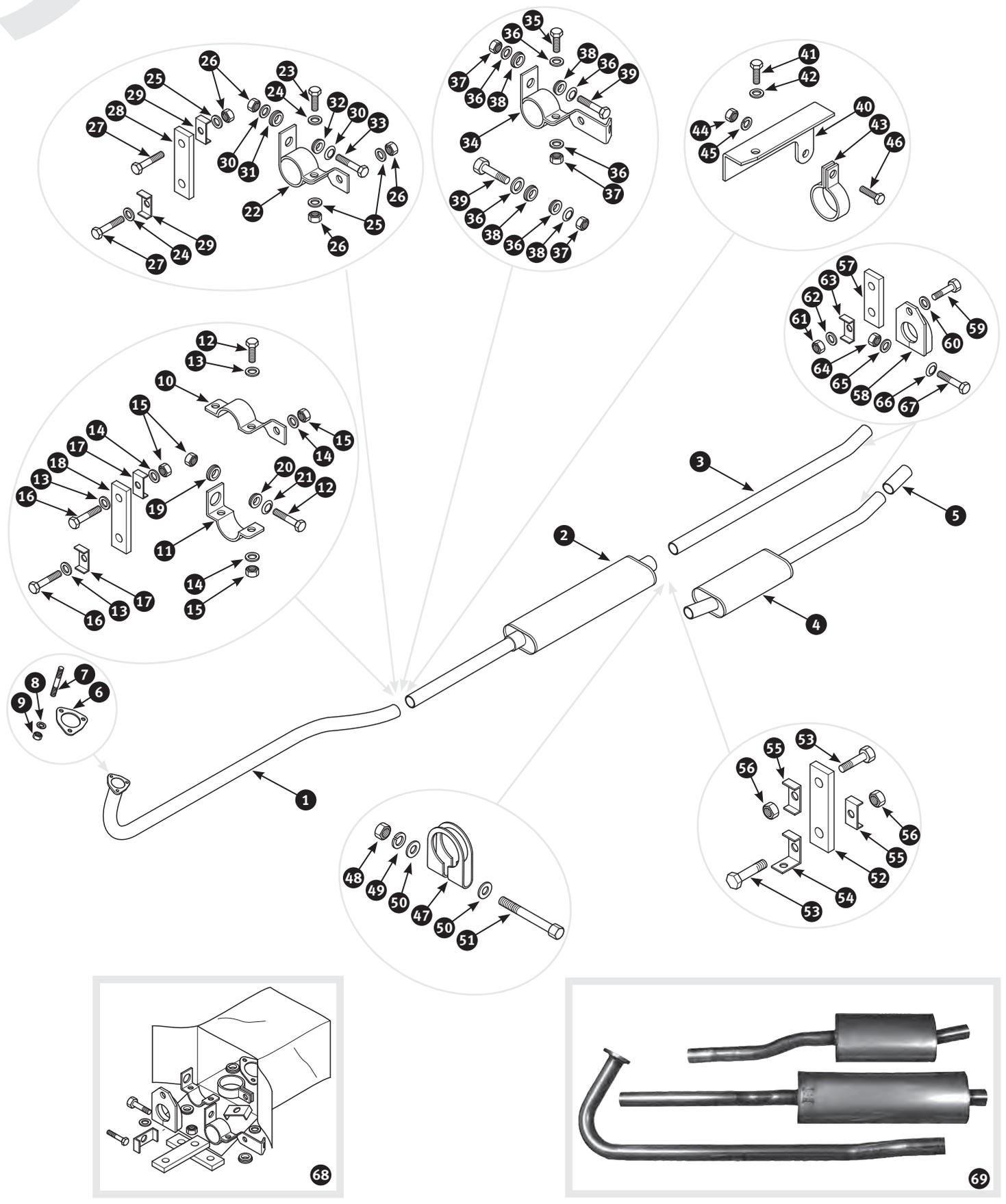



No	Part No	Description	Qty	Notes
1	14073	Down pipe mild steel	1	
1	2629	Down pipe stainless steel	1	
2	1547	Centre silencer mild steel	1	} Length: 24". May replace original 18" silencer used on TR2 to TS2532
2	2630	Centre silencer stainless steel	1	
3	16364	Tail pipe mild steel	1	} TR2, TR3 to TS11716
3	337601	Tail pipe stainless steel	1	
4	1474	Rear silencer mild steel	1	} TR3 from TS11717, TR3A, TR3B and TR4
4	2631	Rear silencer stainless steel	1	
5	15979	Chrome finisher tail pipe	1	
6	976	Gasket exhaust manifold to down pipe	1	
7	5040	Stud exhaust manifold to down pipe	3	
8	2051	Spring washer	3	
9	201055	Brass nut	3	
10	299657	Clamp front exhaust mounting - upper half	1	} TR2 to TS4309. If not available use clamp 13835 (ill. 34)
11	299656	Clamp front exhaust mounting - lower half	1	
12	2826	Screw	3	} TR2 to TS4309 - front exhaust mounting
13	212193	Plain washer	4	
14	212194	Spring washer	5	
15	2303	Nut	5	
16	7895	Screw	2	
17	1004	Clamping plate on rubber strap	2	
18	2649	Rubber strap	1	
19	995	Rubber bush	1	
20	996	Rubber washer	1	
21	10487	Plain washer	1	
22	295843	Clamp front exhaust mounting	1	
23	2826	Screw	1	
24	212193	Plain washer	3	} TR2 from TS4310, TR3 to TS11716 - front exhaust mounting
25	212194	Spring washer	3	
26	2303	Nut	4	
27	7895	Screw	2	
28	2649	Rubber strap	1	
29	1004	Clamping plate on rubber strap	2	
30	10487	Plain washer	2	
31	995	Rubber bush	2	
32	996	Rubber washer	1	
33	213876	Bolt	1	
34	13835	Clamp	1	
35	2826	Screw	1	
36	10487	Plain washer	6	
37	329880	Steel nut	3	
38	995	Rubber bush	4	
39	213876	Bolt	2	
40	16456	Exhaust bracket	1	} TR4 - front exhaust mounting
41	13927	Screw	1	
42	7461	Spring washer	1	
43	12512	Ring clamp exhaust to bracket	1	
44	2303	Nut	1	
45	212194	Spring washer	1	
46	2826	Screw	1	
47	1691	Exhaust clamp	1	
48	2303	Nut	1	
49	212194	Spring washer	1	
50	212193	Plain washer	2	
51	213915	Bolt	1	

9.2

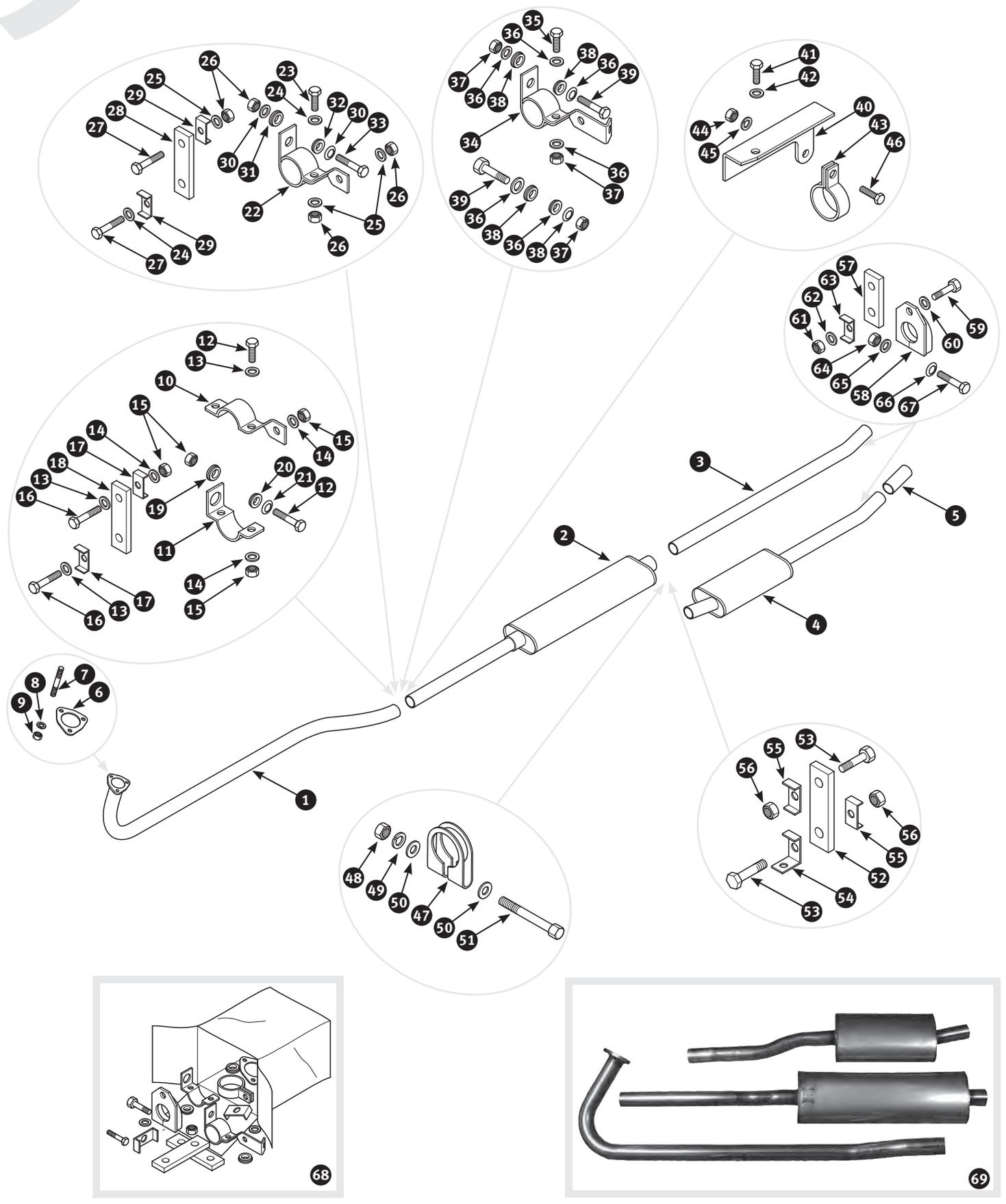

No	Part No	Description	Qty	Notes
52	2649	Rubber strap	1	TR4 from CT114544 - middle exhaust mounting
53	2826	Screw	2	
54	4281	Bracket rubber strap to exhaust clamp	1	
55	1004	Clamping plate on rubber strap	2	
56	7455	Nyloc nut	1	
57	2649	Rubber strap	1	Rear exhaust mounting
58	13836	Exhaust mounting clamp	1	
59	2826	Screw	2	
60	212193	Plain washer	2	
61	2303	Nut	2	
62	212194	Spring washer	2	
63	1004	Clamping plate on rubber strap	2	
64	2303	Nut	1	
65	212194	Spring washer	1	
66	212193	Plain washer	1	
67	213881	Bolt	1	TR3 from TS11717, TR3A and TR3B. Must be modified when using on earlier models
68	20760	Exhaust mounting kit	1	
68	20761	Exhaust mounting kit	1	TR4 Please find further exhaust systems in chapter 21.10
69	928	Exhaust system stainless steel	1	

Exhaust jointing compound

this paste has excellent lubrication properties and provides carbon monoxide proof joints on all exhaust systems, from manifold to tail pipe. Withstand extreme temperatures up to 1150°C. 100 g tube.
Part no.304320



Exhaust pipe cutter

for clean and easy cutting of up to 2 mm thick pipes, diameterrange from 35 to 64 mm
Part no.464591

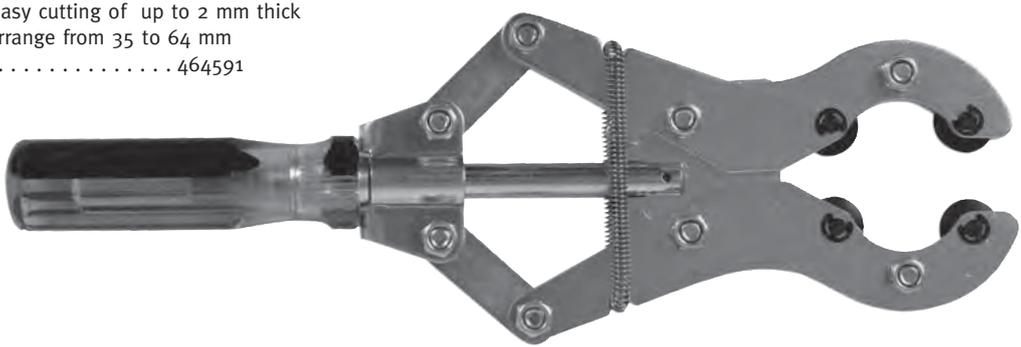

9.3

Identiy by twin box silencer system

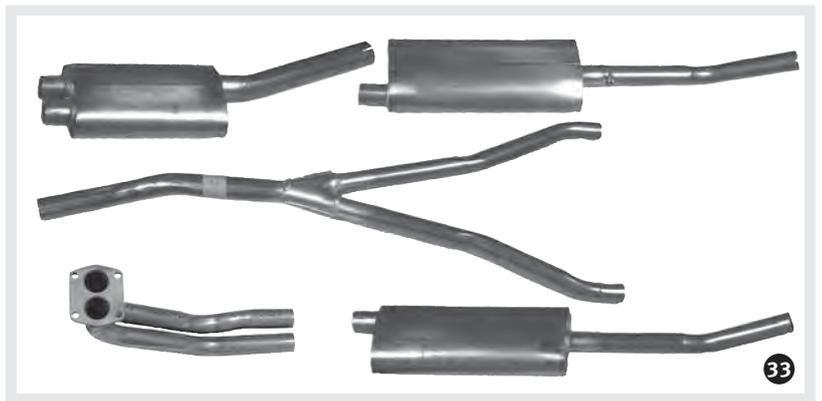
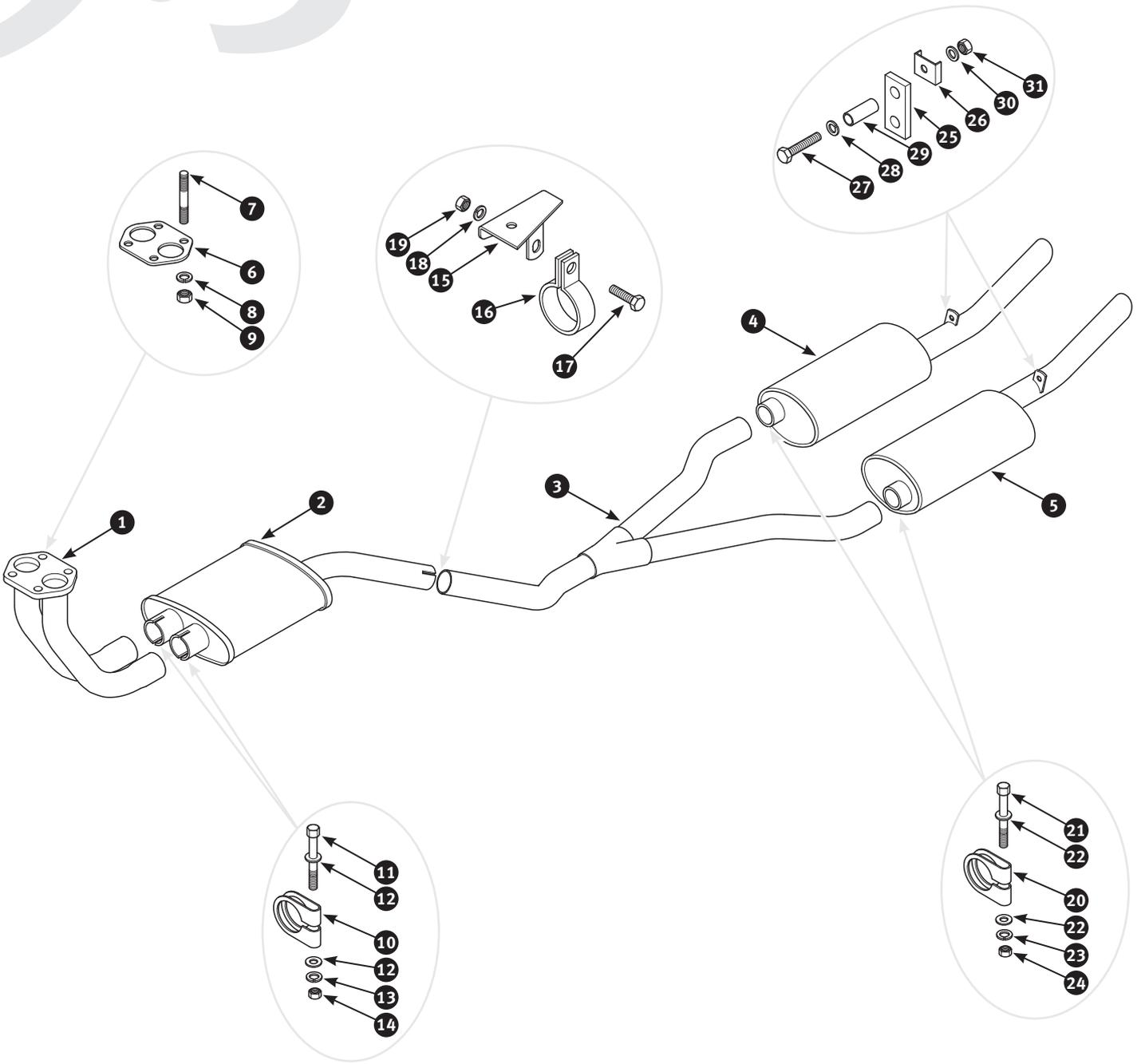

No	Part No	Description	Qty	Notes
1	978	Down pipe mild steel.	1	
1	2268	Down pipe stainless steel.	1	
2	1246	Front silencer mild steel.	1	
2	2632	Front silencer stainless steel.	1	
3	1247	,Y' exhaust pipe mild steel.	1	
3	2635	,Y' exhaust pipe stainless steel.	1	
4	1249	Rear silencer RH - mild steel.	1	
4	2634	Rear silencer RH - stainless steel.	1	
5	1248	Rear silencer LH - mild steel.	1	
5	2633	Rear silencer LH - stainless steel.	1	
6	977	Gasket exhaust manifold to down pipe	1	
7	2375	Stud exhaust manifold to down pipe.	4	
8	2051	Spring washer	4	
9	201055	Brass nut	4	
10	485472	Exhaust clamp down pipe to front silencer.	2	
11	213881	Bolt	2	
12	212193	Plain washer	4	
13	212194	Spring washer	2	
14	2303	Nut	2	
15	2402	Bracket exhaust system to RH gearbox mounting	1	} Front exhaust mounting
16	12512	Ring clamp exhaust system to bracket.	1	
17	2826	Screw	1	
18	212194	Spring washer	1	
19	2303	Nut	1	
20	485472	Exhaust clamp ,Y' exhaust pipe to rear silencer	2	
21	213881	Bolt	2	
22	212193	Plain washer	4	
23	212194	Spring washer	4	
24	2303	Nut	2	
25	997	Rubber strap rear silencer to chassis.	2	} Rear exhaust mounting
26	1004	Clamping plate on rubber strap.	4	
27	2826	Screw	4	
28	212193	Plain washer	4	
29	3356	Sleeve	4	
30	212194	Spring washer	4	
31	2303	Nut	4	
32	20762	Exhaust mounting kit	1	
33	1916	Exhaust system stainless steel	1	} Please find further exhaust systems in chapter 21.10

Spreader

for exhaust pipes. Enables the smooth widening of pipes and makes the installation and the making of exhaust system a lot easier. Eight segments are pushed apart by the internal cone that can be driven with your regular tools.

29 - 44 mm
Part no. 218998

38 - 64 mm
Part no. 241776

54 - 87 mm
Part no. 245511

Spreader set

supplied in a set of 3 different sizes for expanding exhaust pipes. Diameter: 29 mm - 87 mm
Part no. 291767



9.4

Manifold and exhaust Exhaust system - TR4A from approx. CTC70001

Identify by cross box silencer system

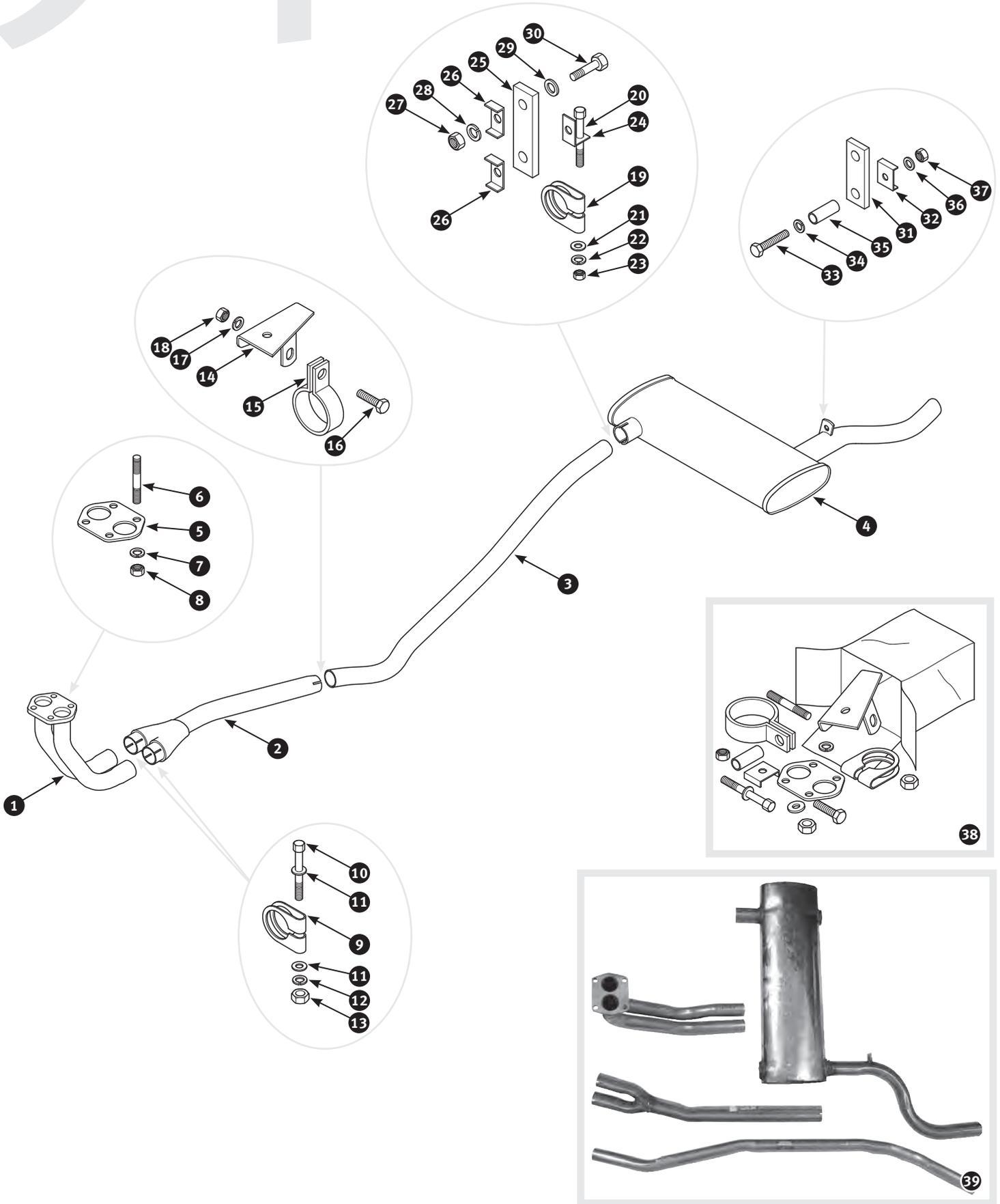

No	Part No	Description	Qty	Notes
1	978	Down pipe mild steel	1	
1	2268	Down pipe stainless steel	1	
2	1544	,Y' exhaust pipe mild steel	1	
2	2637	,Y' exhaust pipe stainless steel	1	
3	1951	Exhaust pipe mild steel	1	
3	2636	Exhaust pipe stainless steel	1	
4	11640	Rear silencer mild steel	1	
4	2638	Rear silencer stainless steel	1	
5	977	Gasket exhaust manifold to down pipe	1	
6	2375	Stud exhaust manifold to down pipe	4	
7	2051	Spring washer	4	
8	201055	Brass nut	4	
9	485472	Exhaust clamp down pipe to ,Y' pipe	2	
10	213881	Bolt	2	
11	212193	Plain washer	4	
12	212194	Spring washer	2	
13	2303	Nut	2	
14	2402	Bracket exhaust system to RH gearbox mounting	1	Front exhaust mounting
15	12512	Ring clamp exhaust system to bracket	1	
16	2826	Screw	1	
17	212194	Spring washer	1	Middle exhaust mounting
18	2303	Nut	1	
19	1691	Exhaust clamp	1	
20	213881	Bolt	1	
21	212193	Plain washer	2	
22	212194	Spring washer	1	Rear exhaust mounting
23	2303	Nut	1	
24	4281	Bracket rubber strap to exhaust clamp	1	
25	998	Rubber strap	1	
26	1004	Clamping plate on rubber strap	4	
27	2303	Nut rubber strap to rear exhaust and chassis	4	
28	212194	Spring washer rubber strap to rear exhaust and chassis	4	
29	212193	Plain washer rubber strap to rear exhaust and chassis	4	Please find further exhaust systems in chapter 21.10
30	2826	Screw rubber strap to rear exhaust and chassis	4	
31	997	Rubber strap	1	
32	1004	Clamping plate	2	
33	2826	Screw	2	
34	212193	Plain washer	2	
35	3356	Sleeve	2	
37	212194	Spring washer	2	
38	20763	Exhaust mounting kit	1	
39	1917	Exhaust system stainless steel	1	

Copper paste

100 g tube

Part no. 329423



10.1

Steering

Steering box and steering wheel - TR2, TR3, TR3A and TR3B

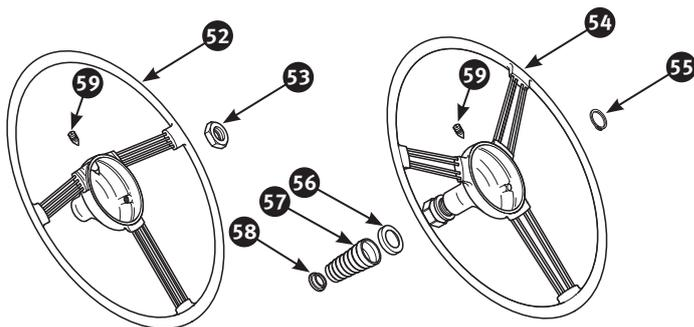
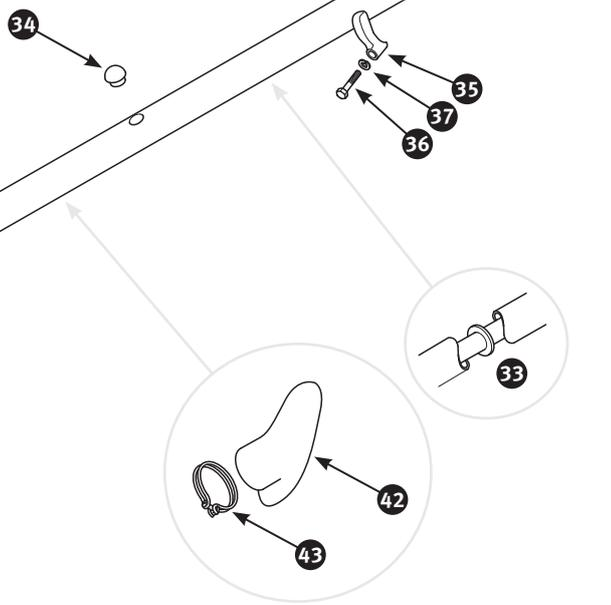
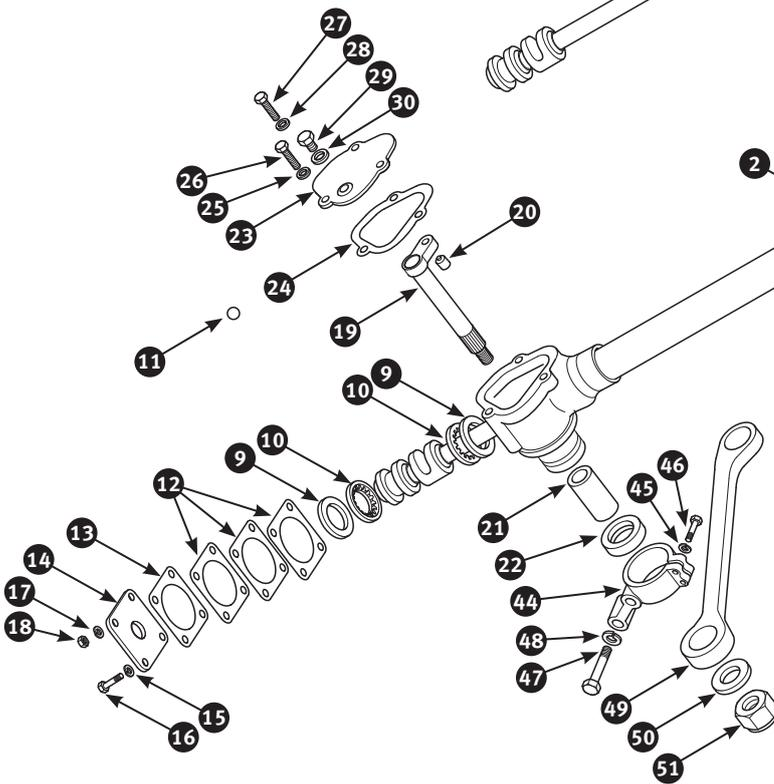
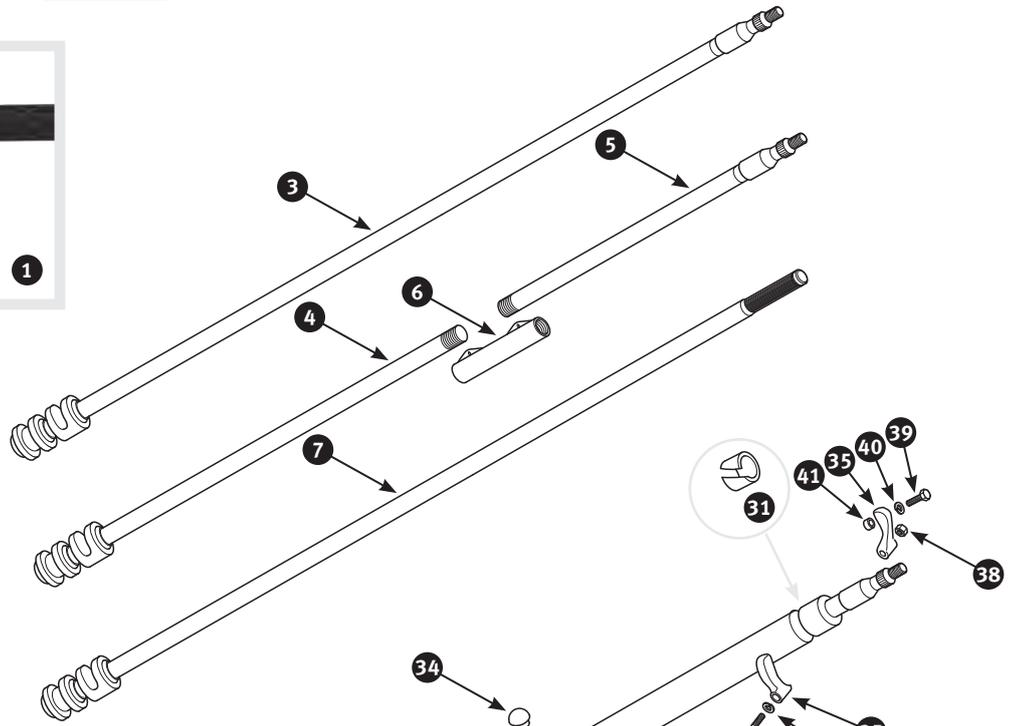
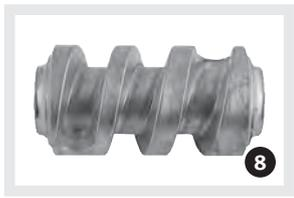

No	Part No	Description	Qty	Notes
1	469232	Steering box exchange - rigid column type.	1	} RHD
1	200524	Steering box exchange - split column type.	1	
1	297159	Steering box exchange - adjustable type	1	} LHD
1	324656	Steering box exchange - rigid column type.	1	
1	213017	Steering box exchange - split column type.	1	
1	214854	Steering box exchange - adjustable type	1	} Cars with rigid type column
2	18981	Housing steering box - RHD	1	
2	469251	Housing steering box - LHD	1	} Cars with split type column
2	18983	Housing steering box, lower section - RHD.	1	
2	313948	Housing steering box, lower section - LHD.	1	} Cars with rigid type column
2	337467	Housing steering column, upper section	1	
3	19129	Steering column with worm - RHD.	1	} Cars with split type column
3	214629	Steering column with worm - LHD.	1	
4	455732	Steering column lower, with worm - RHD	1	} Cars with split type column
4	203654	Steering column lower, with worm - LHD	1	
5	320310	Steering column upper - split type	1	
6	299717	Adaptor lower to upper column	1	
7	19130	Steering column adjustable type.	1	} RHD
7	19128	Steering column adjustable type.	1	
8	19126	Worm steering box	1	} RHD
8	19127	Worm steering box	1	
9	3437	Ball cup steering worm	2	
10	3436	Ball bearing steering worm.	2	
11	6906	Steel ball ball bearing - separately	0	} Quantity as required
12	2723	Shim 0.0025"	0	
12	201802	Shim 0.0050"	0	
12	203843	Shim 0.0100"	0	
13	205321	Gasket cover plate.	1	
14	205294	Cover plate steering box	1	
15	212194	Spring washer	4	
16	212162	Screw cover plate to steering box.	4	
17	201832	Olive on stator tube.	1	
18	4053	Brass nut	1	
19	4553	Rocker shaft with peg	1	
20	16265	Peg for rocker shaft	1	
21	201823	Bush rocker shaft in steering box	1	
22	360	Oil seal rocker shaft.	1	
23	299720	Cover steering box, upper - RHD	1	} With adjusting bolt, spring and nut assembly
23	468144	Cover steering box, upper - LHD	1	
24	361	Gasket cover to steering box	1	
25	212194	Spring washer	3	
26	212162	Screw cover to steering box.	3	
27	203737	Adjusting screw rocker shaft.	1	
28	20498	Nut for adjusting screw	1	
29	299721	Screw plug	1	
30	3807	Fibre washer	1	
31	3394	Felt bush steering column	1	} Cars with rigid type column
32	100	Bush steering column - original type.	2	
32	343863	Bush steering column - uprated type.	2	} Cars with split type column
33	3439	,O' ring anti-rattle, on inner column.	2	
34	4110	Blanking plug - outer tube	1	
35	337446	Clamp steering column to fascia.	2	
36	6526	Bolt clamp to steering column	1	
37	212193	Plain washer	1	
38	2303	Nut	1	
39	2826	Screw clamp to fascia	2	
40	212194	Spring washer	2	

10.1

Steering

Steering box and steering wheel - TR2, TR3, TR3A and TR3B

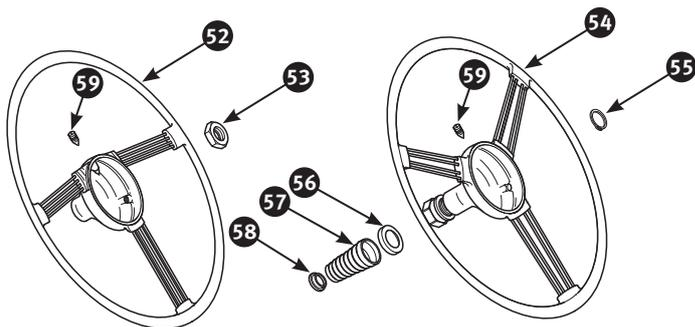
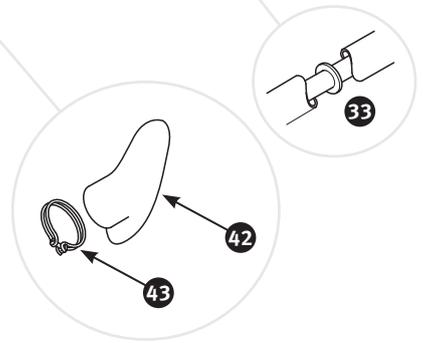
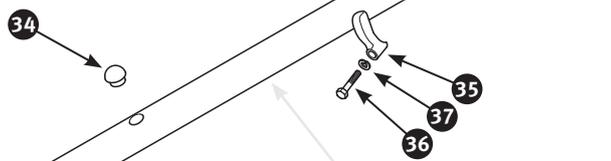
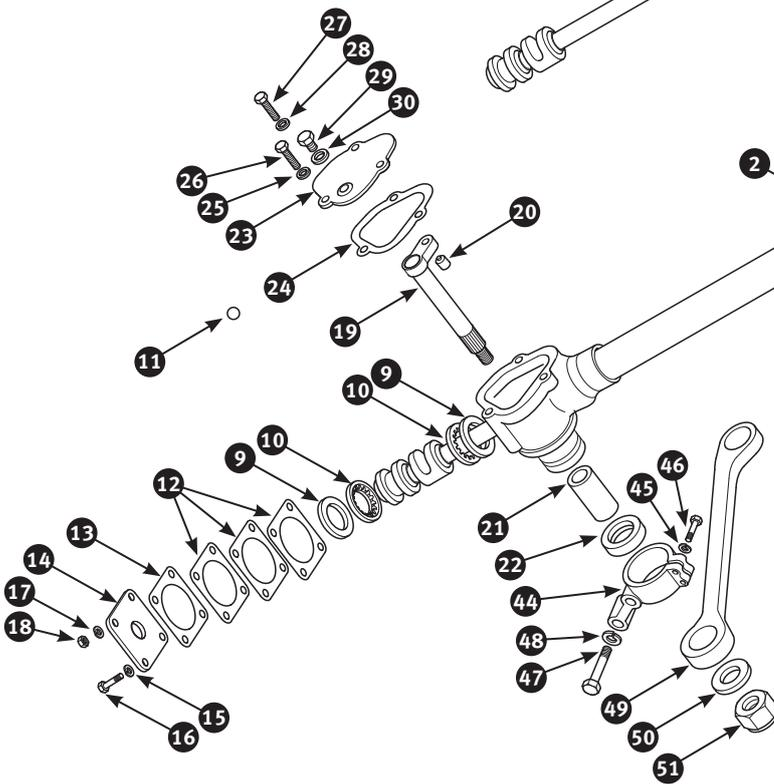
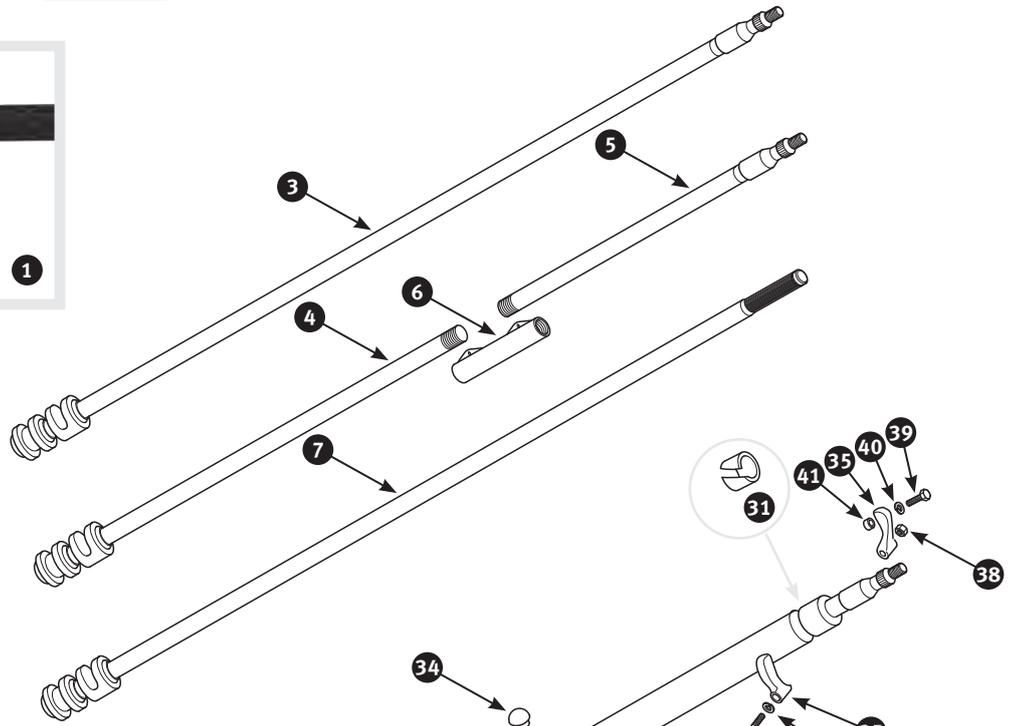

No	Part No	Description	Qty	Notes
41	2303	Nut	2	
42	2518	Gaiter steering column through bulkhead.	1	
43	10063	Hose clip gaiter to steering column.	1	
44	213018	Bracket steering	1	} RHD } LHD
44	468153	Bracket steering	1	
45	212194	Spring washer	2	
46	6524	Bolt bracket to steering unit.	2	
47	6540	Bolt bracket to body	2	
48	2051	Spring washer	2	
49	299723	Steering lever	1	} RHD } LHD
49	213019	Steering lever	1	
50	2448	Locking washer	1	
51	16051	Nut	1	
52	10596	Steering wheel - non adjustable type.	1	} Cars fitted with non adjustable steering wheel
53	2337	Nut	1	
54	16498	Steering wheel - adjustable type.	1	} Cars fitted with adjustable steering wheel
55	298575	Retaining clip	1	
56	19284	Cap spiral to steering wheel.	1	
57	215193	Spiral steering column - chromed	1	
58	299714	Cap spiral to steering box	1	
59	3412	Grub screw horn push to steering wheel	3	
60	20735	Unipart Gearbox oil Hypoid EP90 for steering boxes, 0.5 litre bottle.	1	} Please find further oils and lubricants in chapter 21.31

Control head

for adjustable wheel
Part no.20853

for fixed steering wheel
Part no.19245



Wire brush

for battery terminal maintenance.
Metal case.
Part no.479851

for battery terminal maintenance.
Metal case, nickel plated
Part no.479850



10.2

Steering

Steering rods and steering idler - TR2, TR3, TR3A and TR3B

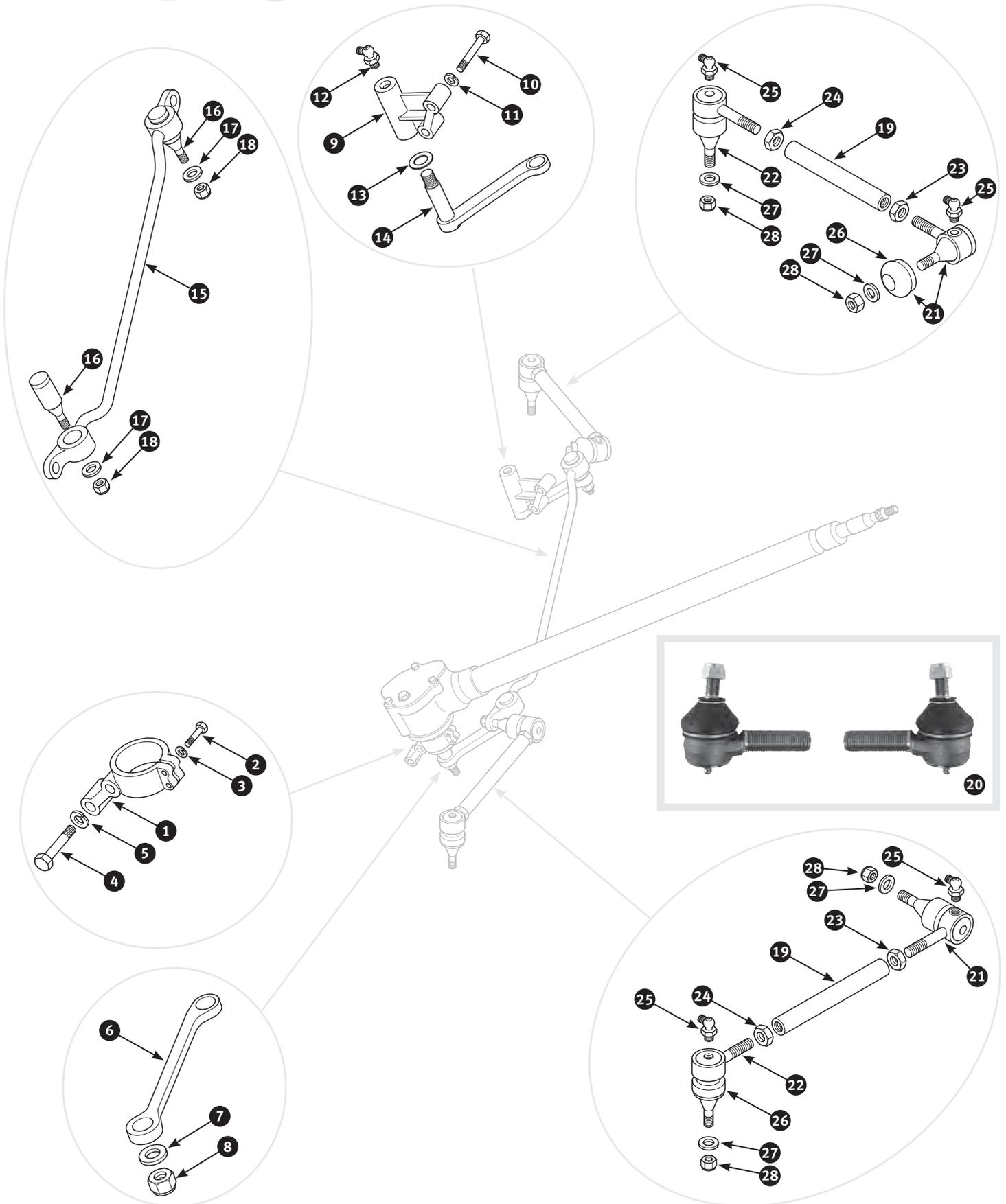

No	Part No	Description	Qty	Notes
1	213018	Bracket steering	1	} RHD
1	468153	Bracket steering	1	
2	6524	Bolt bracket to steering	2	
3	212194	Spring washer	2	
4	6540	Bolt bracket to body	2	
5	2051	Spring washer	2	
6	299723	Steering lever	1	} RHD
6	213019	Steering lever	1	
7	2448	Locking washer	1	
8	16051	Nut steering lever to rocker shaft	1	
9	364	Idler box	1	
10	6540	Bolt idler box to chassis.	2	
11	2051	Spring washer	2	
12	16633	Grease nipple idler lever.	1	
13	3404	Seal idler lever to idler box	1	
14	18030	Idler lever	1	
15	470769	Steering rod centre - new item	1	
15	213094	Steering rod centre - used item.	1	
16	201048	Bush and pin - steering rod	2	
17	212195	Plain washer	2	
18	212110	Nyloc nut	2	
19	3758	Steering rod outer.	2	
20	16618	Tie rod ends for one side of car	2	} Supplied in pairs
21	298340	Tie rod end inner - with right hand thread	2	
22	298341	Tie rod end outer - with left hand thread	2	
23	3759	Nut for inner tie rod end	2	
24	3760	Nut for outer tie rod end	2	
25	3345	Grease nipple for original type tie rod end only	4	
26	5170	Gaiter tie rod end	4	
27	212195	Plain washer	4	
28	212110	Nyloc nut tie rod end.	4	

4 Catalogues, you must have:

- Oils and lubricants
- Tuning and more
- Accessories
- Tools



Order online: www.Limora.com • www.scparts.co.uk



Spreader

for tie rod ends from 19 to 22 mm.
Adjustable heavy duty type

Part no. 302057

10.3

Steering

Steering rack - TR4 and TR4A

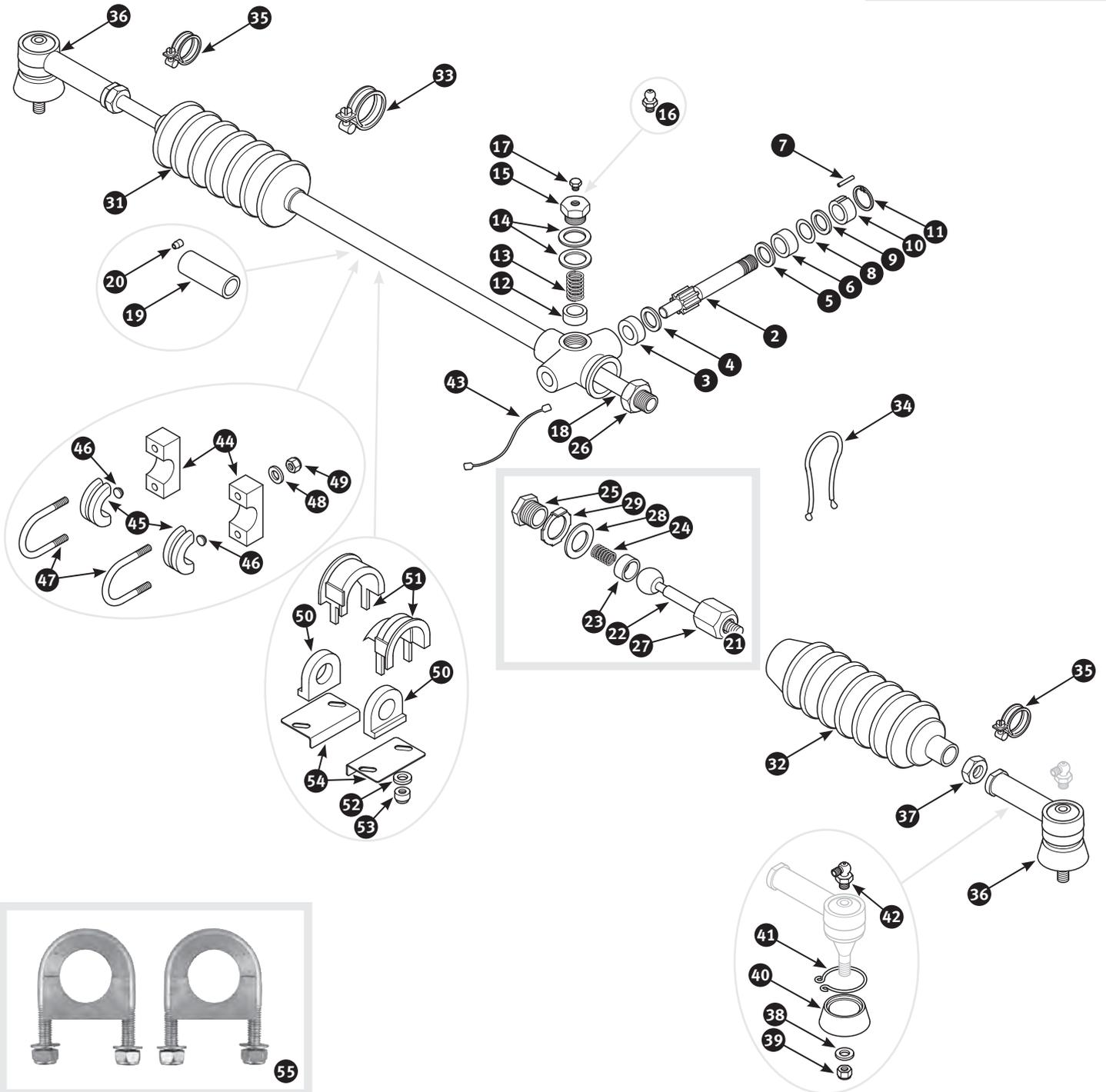

No	Part No	Description	Qty	Notes
1	214654	Steering rack new - length: 1023 mm	1	} TR4 RHD to CT20265. Mounted with aluminium blocks to chassis
1	11392	Steering rack exchange - length: 1023 mm	1	
1	214653	Steering rack new - length: 1023 mm	1	} TR4 LHD to CT20063. Mounted with aluminium blocks to chassis
1	11393	Steering rack exchange - length: 1023 mm	1	
1	214656	Steering rack new - length: 1023 mm	1	} TR4 RHD from CT20266. Mounted with rubber bushes to chassis
1	16187	Steering rack exchange - length: 1023 mm	1	
1	467517	Steering rack new - length: 1023 mm	1	} TR4 LHD from CT20064. Mounted with rubber bushes to chassis
1	20746	Steering rack exchange - length: 1023 mm	1	
1	10398	Steering rack new - length: 1003 mm	1	} TR4A RHD. Mounted with rubber bushes to chassis
1	10399	Steering rack exchange - length: 1003 mm	1	
1	104	Steering rack new - length: 1003 mm	1	} TR4A LHD. Mounted with rubber bushes to chassis
1	2429	Steering rack exchange - length: 1003 mm	1	
1	314954	Steering rack high ratio type.	1	} TR4 RHD from CT20266, TR4A RHD
1	314953	Steering rack high ratio type.	1	
2	214648	Pinion steering rack.	1	} RHD
2	214647	Pinion steering rack.	1	
3	291250	Bush pinion lower	1	} LHD
4	291359	Thrust washer pinion lower	1	
5	298663	Thrust washer pinion upper	1	
6	9803	Bush pinion upper.	1	
7	291360	Locating peg	1	
8	3259	,O' ring pinion.	1	
9	298661	Shim pinion - 0.005"	0	} Quantity as required
9	298662	Shim pinion - 0.010"	0	
10	9782	Collar pinion	1	
11	5552	Retaining clip	1	
12	291355	Plunger steering rack bar	1	
13	291357	Spring plunger	1	
14	291310	Shim plunger - 0.002"	0	} Quantity as required
14	5258	Shim plunger - 0.004"	0	
14	289798	Shim plunger - 0.010"	0	
15	13279	Blanking plug	1	
16	316197	Grease nipple	1	} Alternatives
17	11445	Screw plug	1	
18	2967	Rack bar steering	1	
19	9564	Bush steering rack bar	1	} On passenger side of rack tube
20	5516	Plug for buffering	1	
21	291061	Steering rod with ball joint assembly.	2	} TR4. Length: 200 mm
22	16162	Steering rod separately	1	
21	2088	Steering rod complete with ball joint assembly.	2	} TR4A. Length: 190 mm
22	16163	Steering rod separately	2	
23	293178	Pan steering rod ball	2	
24	5492	Spring	2	
25	293739	Adaptor steering rod to rack bar.	2	
26	296140	Nut locking adaptor to rack bar	2	
27	298660	Ball housing steering rod	2	
28	5342	Shim 0.002"	0	} Quantity as required
28	9587	Shim 0.010"	0	
29	5259	Lock tab ball housing	2	
30	16620	Steering rack gaiters - supplied in pairs.	1	

10.3

Steering

Steering rack - TR4 and TR4A

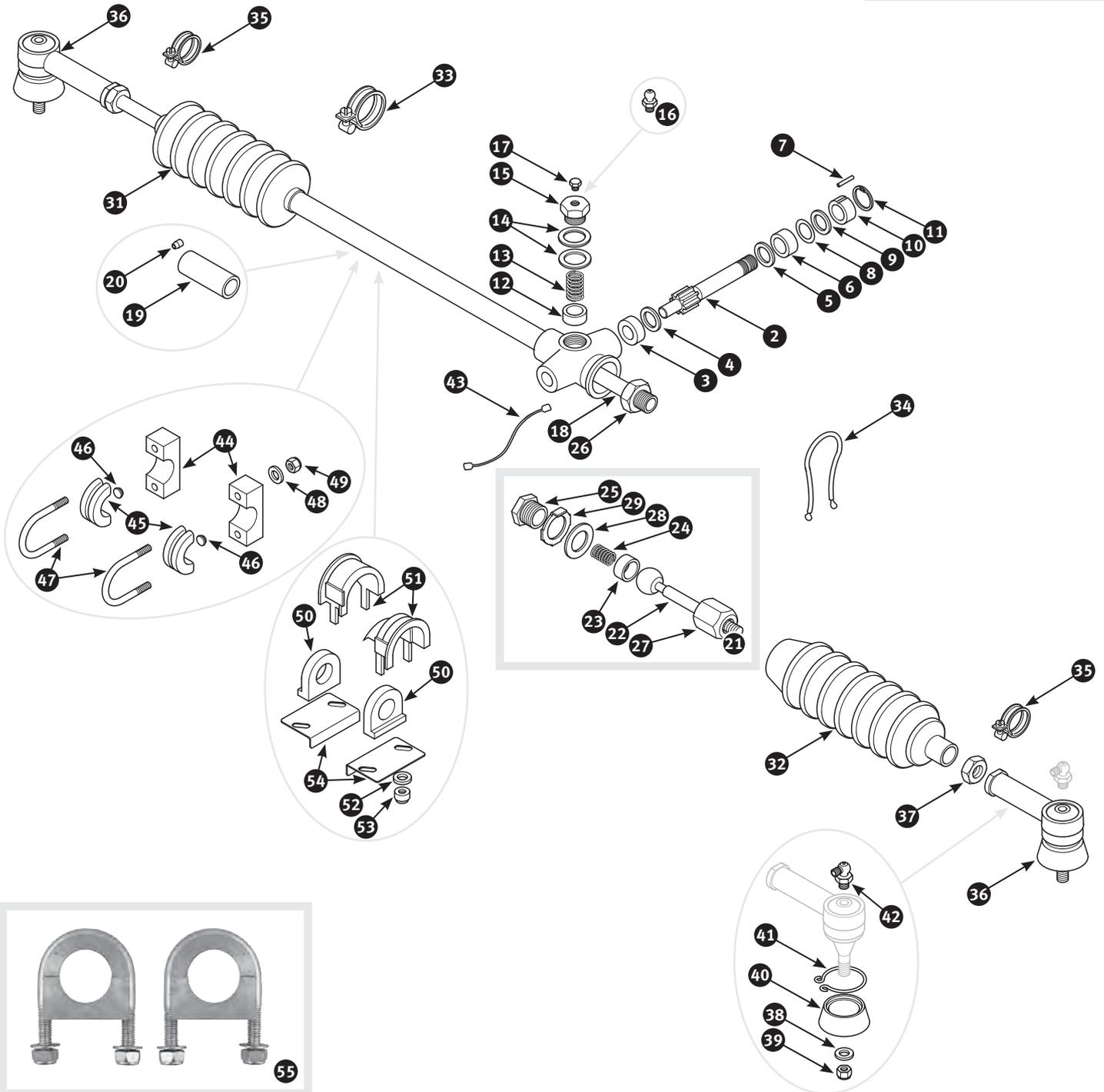

No	Part No	Description	Qty	Notes
31	16296	Steering rack gaiter passenger side	1	
32	16297	Steering rack gaiter driver side	1	
33	1552	Hose clip gaiter to rack - passenger side	1	
34	4869	Lock wire gaiter to rack - driver side	1	
35	7147	Hose clip gaiter to steering rod	2	
36	201034	Tie rod end standard type	2	
36	347706	Tie rod end reinforced type	2	
37	3201	Nut locking tie rod end	2	
38	212197	Plain washer	2	
39	7456	Nyloc nut tie rod end to vertical link	2	
40	202248	Gaiter track rod end	2	
41	215138	Locking ring gaiter	2	
42	3345	Grease nipple on genuine tie rod end	2	
43	17942	Earth cable steering rack to chassis	1	
44	20757	Mounting block steering rack - Aluminium	2	TR4 RHD to CT20265, TR4 LHD to CT20063
45	5317	Clamp steering rack	2	
46	300663	Dowel	2	
47	10933	,U' bolt steering rack	2	
48	212195	Plain washer	4	TR4 RHD from CT20266, TR4 LHD from CT20064, TR4A
49	7455	Nyloc nut	4	
50	3995	Rubber bush steering rack mounting	2	
50	25799	Polyurethane bush steering rack mounting - uprated version	2	
51	9565	Clamp steering rack	2	TR4 RHD from CT20266, TR4 LHD from CT20064, TR4A
52	212193	Plain washer	4	
53	7455	Nyloc nut	4	
54	10340	Fixing bracket steering rack	2	
55	17053	Fitting kit steering rack - uprated aluminium version	1	TR4 RHD from CT20266, TR4 LHD from CT20064, TR4A. Replacement for rubber mountings

Moto-Lita Mark 4 leather rim steering wheel
 with 3 polished spokes with holes, 14" flat
 Part no.4626

Available in two variants. First selection black cowhide, handsewn over rubber handgrip. Heavy gauge aluminium alloy spokes. Black anodised or polished.



4 Catalogues, you must have:
f.o.c.

- Accessories
- Tuning and more

Tools •
 Oils and lubricants •

Order online: www.Limora.com • www.scparts.co.uk

10.4

Steering

Steering column and steering wheel - TR4 and TR4A

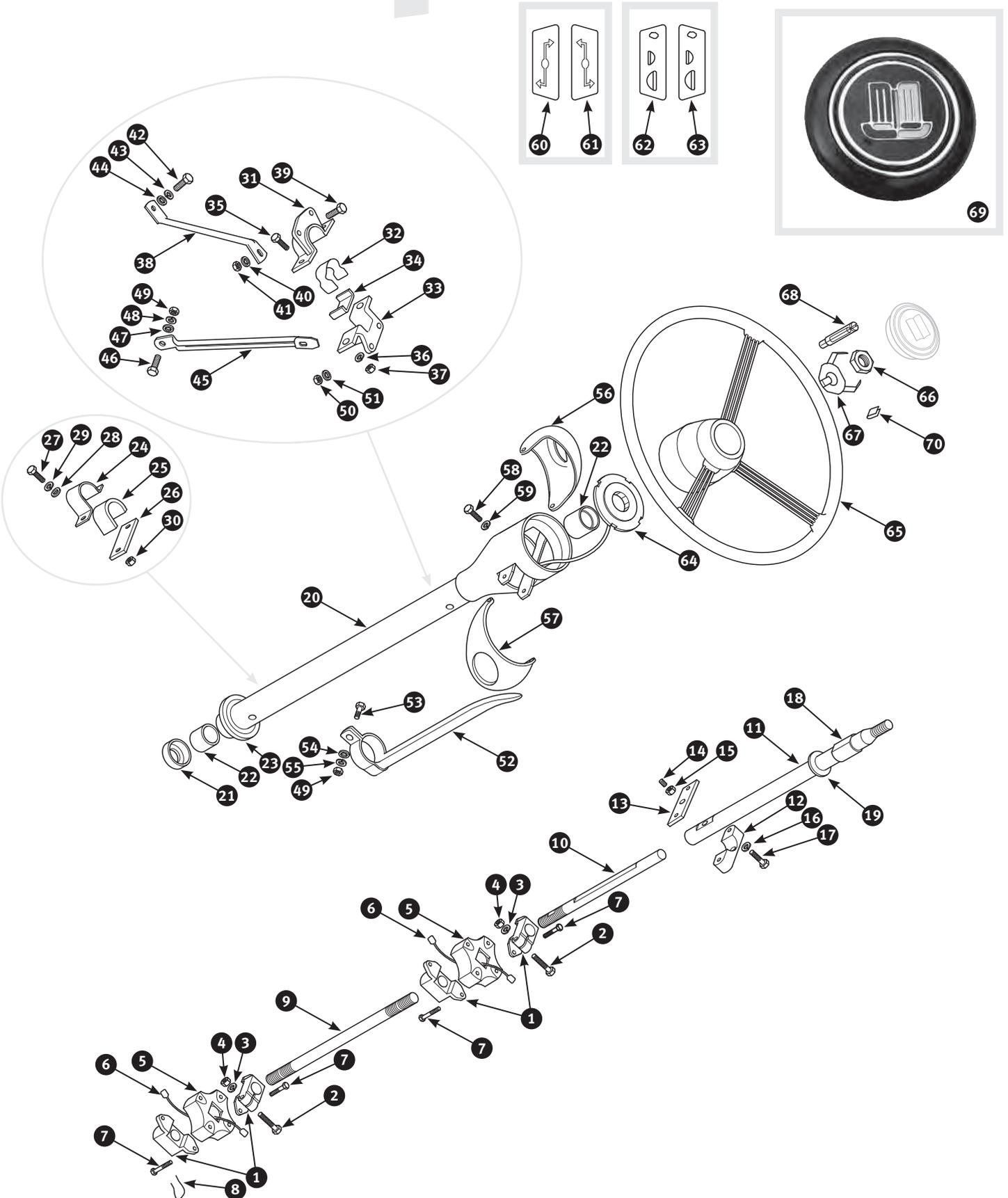

No	Part No	Description	Qty	Notes
1	11799	Adaptor flexible coupling	4	
2	5088	Screw adaptor to steering column	4	
3	212191	Plain washer	4	} Fits to adaptors with 1/4" thread
4	3786	Steel nut	4	
2	6524	Bolt adaptor to steering column	4	} Fits to adaptors with 5/16" thread
3	212193	Plain washer	4	
4	329880	Steel nut	4	} Characteristic: no counterbores
5	297630	Flexible coupling steering column - early type	2	
5	207967	Flexible coupling steering column - late type	2	} Characteristic: 2 holes with 3/8" counterbores
6	1672	Earth cable flexible coupling on steering column	2	
7	9585	Bolt flexible coupling to adaptor	8	} With hole for lock wire - alternatives
7	9558	Allen screw flexible coupling to adaptor	8	
8	215280	Lock wire - supplied per metre	1	
9	13450	Steering column lower section - new item	1	
9	213111	Steering column lower section - used item	1	
10	13451	Steering column upper inner section - new item	1	
10	213109	Steering column upper inner section - used item	1	
11	10608	Sleeve yoke steering column	1	
12	471670	Clamp steering column sleeve - new item	1	
12	213996	Clamp steering column sleeve - used item	1	
13	314789	Fixing plate steering column sleeve - new item	1	
13	10940	Fixing plate steering column sleeve - used item	1	
14	10939	Locating screw steering column sleeve	1	
15	7742	Nut locking locating screw	1	
16	212192	Spring washer	2	
17	6514	Bolt clamp to fixing plate	2	
18	10553	Actuator for indicator switch	1	
19	19389	Nylon washer steering column	1	
20	11611	Outer tube steering column	1	
21	10663	End cap	1	
22	100	Bush steering column - original type	2	} Alternatives
22	343863	Bush steering column - uprated type	2	
23	2212	Grommet outer tube through bulkhead	1	
24	26635	Clamp outer tube - lower	1	
25	9630	Felt strip clamp to steering column - long	1	
26	10444	Felt strip clamp to steering column - short	1	
27	1912	Screw	2	
28	12821	Plain washer	2	
29	212192	Spring washer	2	
30	2828	Nut	2	
31	479157	Clamp steering column, upper - new item	1	
31	26071	Clamp steering column, upper - used item	1	
32	9632	Retaining spring	1	
33	373508	Clamp steering column, lower - new item	1	
33	11222	Clamp steering column, lower - used item	1	
34	1346	Felt strip steering column clamp	1	
35	2826	Screw	2	
36	212194	Spring washer	2	
37	2303	Nut	2	
38	300111	Steady rod upper steering tube clamp to dash	1	
39	1912	Screw steady rod to clamp	1	
40	212192	Spring washer	1	
41	2828	Nut	1	
42	3295	Screw steady rod to dash	1	
43	212192	Spring washer	1	
44	212191	Plain washer	1	

10.4

Steering

Steering column and steering wheel - TR4 and TR4A

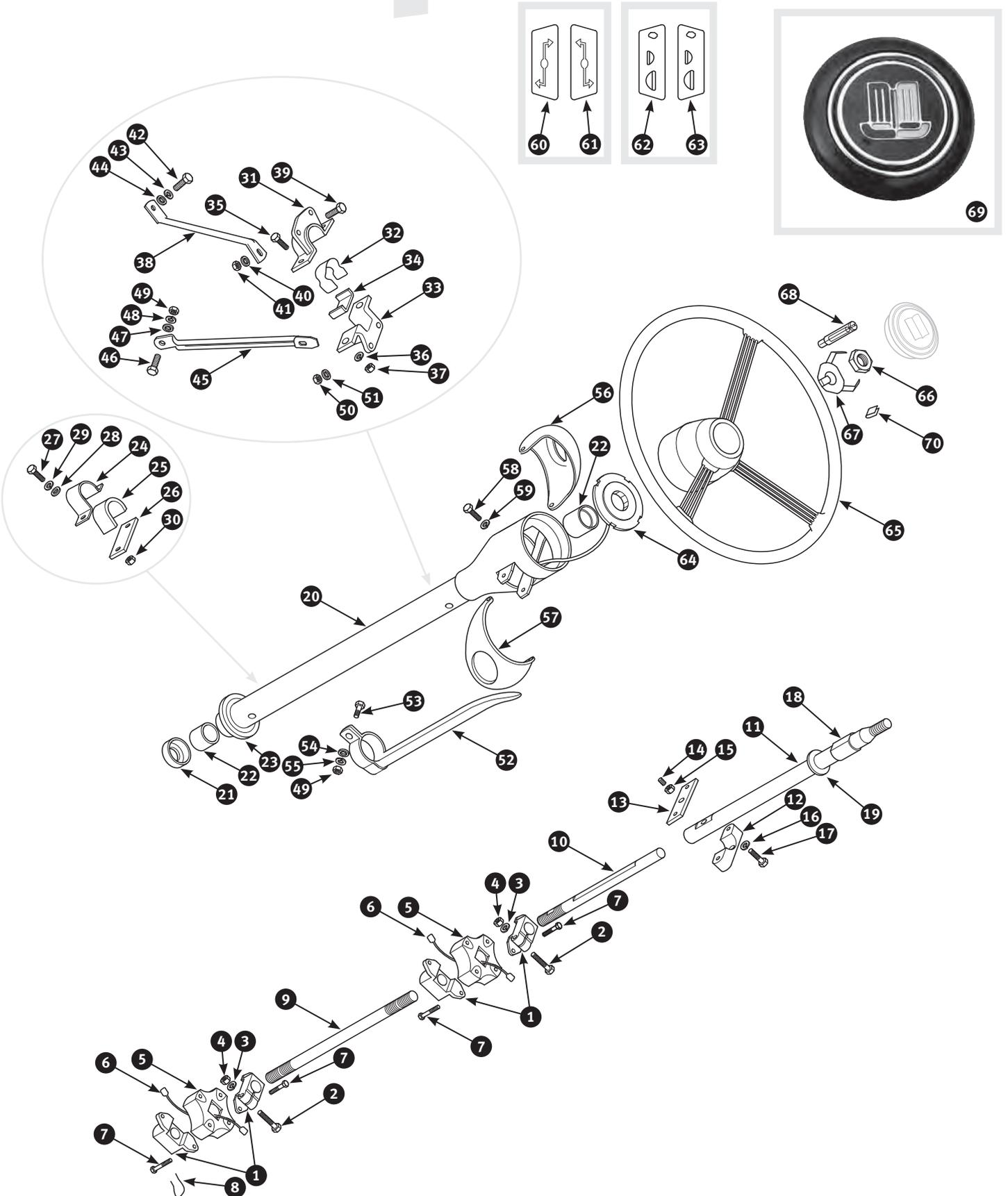

11.1

Rear suspension

Suspension and shock absorber - TR2, TR3, TR3A, TR3B, TR4 to CT23382 with solid axle

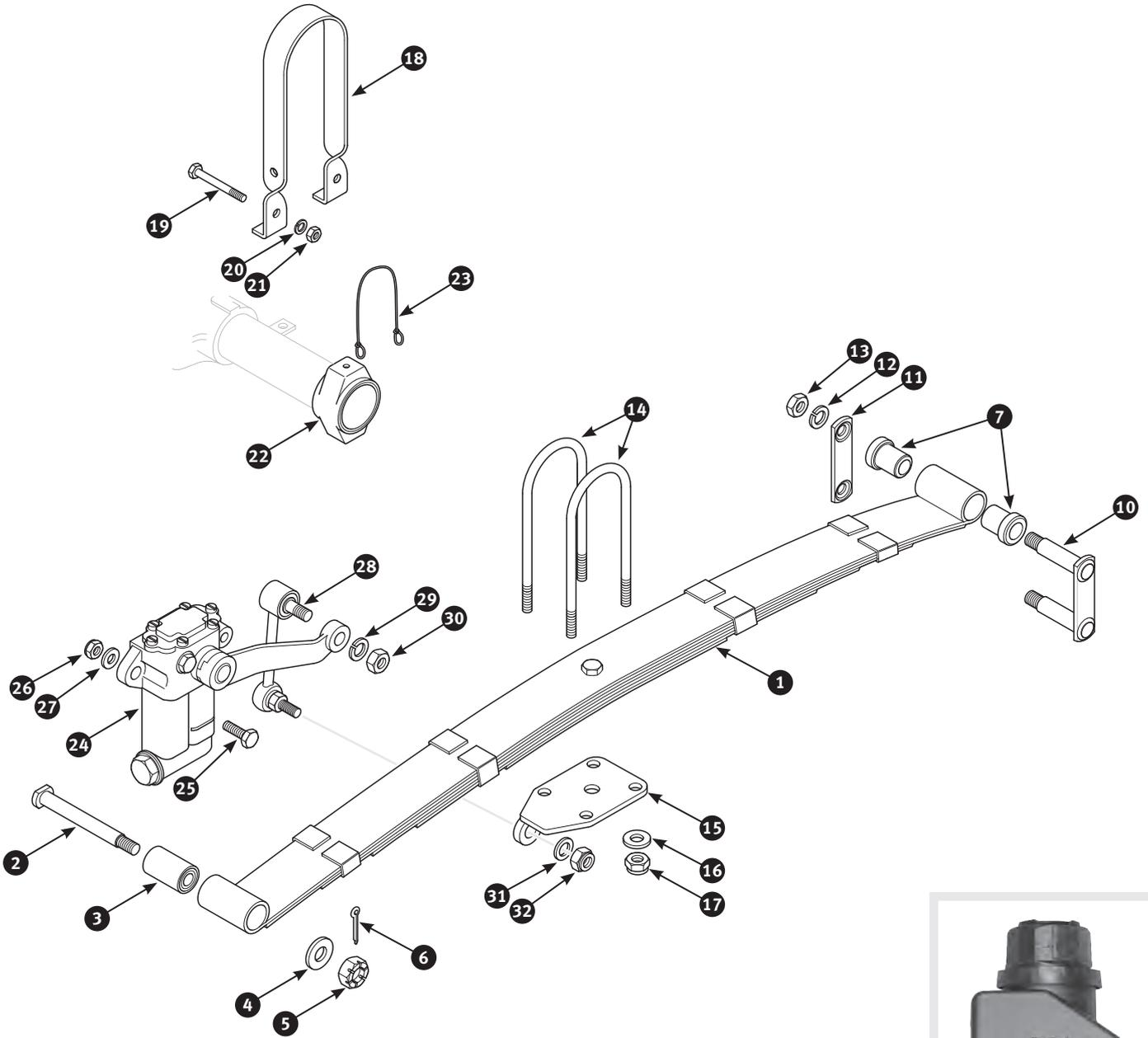

No	Part No	Description	Qty	Notes
1	1314	Leaf spring	2	
2	9556	Bolt leaf spring, front attachment	2	} Alternatives
2	320267	Bolt leaf spring, front attachment - stainless steel	2	
3	201054	Bush leaf spring, front eye	2	
4	5042	Washer ,D' shaped.	2	
5	1998	Slotted nut	2	
6	10477	Split pin	2	
7	245	Rubber bush leaf spring, rear shackle	8	} Alternatives
8	313452	Polyurethane bush leaf spring, rear shackle	8	
9	13034	Nylatron bush leaf spring, rear shackle	8	
10	4759	Shackle leaf spring, rear attachment	2	
11	11319	Shackle plate	2	
12	2051	Spring washer	4	
13	3073	Nut	4	
14	11401	,U' bolt leaf spring.	4	} TR2, TR3 to TS13045 (Lockheed axle) TR3 from TS13046, TR3A, TR3B and TR4 (Girling axle)
14	246	,U' bolt leaf spring.	4	
15	298718	Mounting plate LH leaf spring - new item	1	} TR2, TR3 to TS13045 (Lockheed axle)
15	200348	Mounting plate LH leaf spring - used item	1	
15	360250	Mounting plate RH leaf spring - new item	1	
15	200349	Mounting plate RH leaf spring - used item	1	
15	200352	Mounting plate LH leaf spring - new item	1	} TR3 from TS13046, TR3A, TR3B and TR4 (Girling axle)
15	327742	Mounting plate LH leaf spring - used item	1	
15	200353	Mounting plate RH leaf spring - new item	1	
15	327743	Mounting plate RH leaf spring - used item	1	
16	212195	Plain washer	8	
17	2829	Nyloc nut	8	
18	324911	Check strap metal - new item	2	
18	214792	Check strap metal - used item	2	
19	9917	Anchor bolt check strap	4	} Welded to frame May replace original anchor bolt 9917
19	212779	Bolt check strap to frame	4	
20	2051	Spring washer	4	
21	7741	Nut	4	
22	201059	Rebound buffer rear axle	2	} May be used for earlier models (TR2, TR3 to TS13045) by sectioning to fit the smaller diameter axle tube and wiring in place as originally fastened
23	4869	Lock wire bump stop rubber.	4	
24	2893	Shock absorber RH - new item	1	} For telescopic shock absorber conversion see chapter 21.16
24	2894	Shock absorber RH - exchange	1	
24	2892	Shock absorber LH - new item	1	
24	10817	Shock absorber LH - exchange	1	
25	213888	Screw shock absorber to frame	4	
26	2829	Nyloc nut	4	
27	10844	Plain washer	4	
28	201052	Connection link shock absorber	2	
29	2051	Spring washer	2	
30	3073	Nut	2	
31	10484	Washer	2	
32	2049	Nyloc nut	2	
33	200318	Castrol Damper oil SAE 20W - 500 ml bottle	1	} Please find further oils and lubricants in chapter 21.31

11.2

Rear suspension

Suspension and shock absorber - TR4 from CT23383 with solid axle

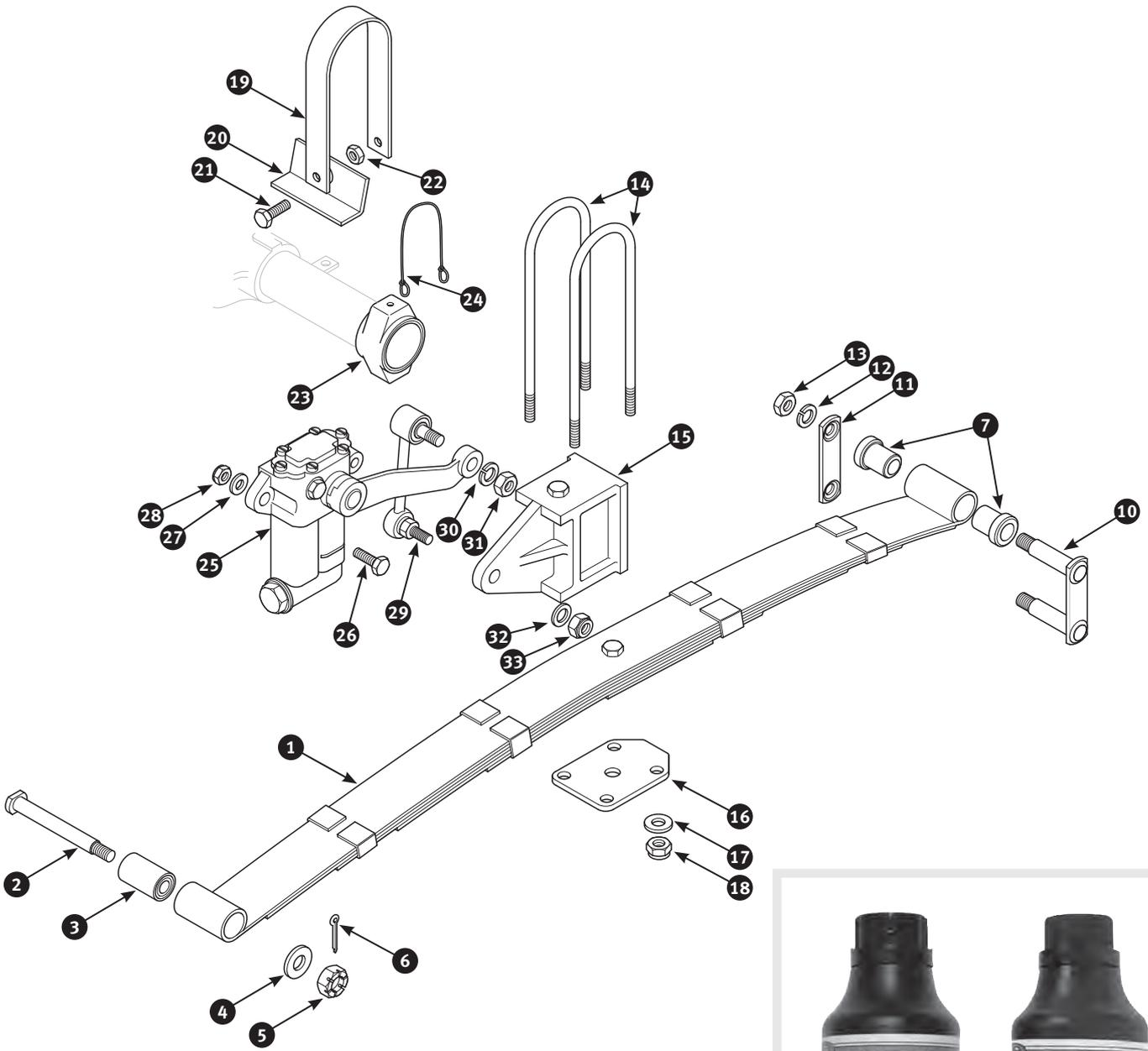

No	Part No	Description	Qty	Notes
1	15724	Leaf spring	2	
2	9556	Bolt leaf spring, front attachment	2	} Alternatives
2	320267	Bolt leaf spring, front attachment - stainless steel	2	
3	201054	Bush leaf spring, front eye	2	
4	5042	Washer ,D' shaped.	2	
5	1998	Slotted nut	2	
6	10477	Split pin	2	
7	245	Rubber bush leaf spring, rear shackle	8	} Alternatives
8	313452	Polyurethane bush leaf spring, rear shackle	8	
9	13034	Nylatron bush leaf spring, rear shackle	8	
10	4759	Shackle leaf spring, rear attachment	2	
11	11319	Shackle plate	2	
12	2051	Spring washer	4	
13	3073	Nut	4	
14	2396	,U' bolt leaf spring.	4	
15	484479	Spacer block LH leaf spring - new item	1	
15	204090	Spacer block LH leaf spring - used item	1	
15	484480	Spacer block RH leaf spring - new item	1	
15	204091	Spacer block RH leaf spring - used item	1	
16	338802	Mounting plate leaf spring - new item	2	
16	200351	Mounting plate leaf spring - used item	2	
17	212195	Plain washer	8	
18	2829	Nyloc nut	8	
19	21401	Check strap metal	2	
20	20849	Bracket check strap	2	
21	2826	Screw check strap to bracket	4	
22	2829	Nyloc nut	4	
23	201059	Rebound buffer rear axle	2	
24	4869	Lock wire bump stop rubber.	4	
25	2893	Shock absorber RH - new item	1	} For telescopic shock absorber conversion see chapter 21.16
25	2894	Shock absorber RH - exchange	1	
25	2892	Shock absorber LH - new item	1	
25	10817	Shock absorber LH - exchange	1	
26	213888	Screw shock absorber to frame.	4	
27	10844	Plain washer	4	
28	2829	Nyloc nut	4	
29	201052	Connection link shock absorber	2	
30	2051	Spring washer	2	
31	3073	Nut link to shock absorber arm.	2	
32	10484	Washer	2	
33	2049	Nyloc nut link to spacer block.	2	
34	373933	Penrite Damper oil no.1, replaces following oil: SAE 20W - 500 ml bottle	1	} Please find further oils and lubricants in chapter 21.31
34	305185	Penrite Damper oil no.2, replaces following oil: SAE 20W - 500 ml bottle	1	

11.3

Rear suspension

Suspension and shock absorber - TR4A with solid axle

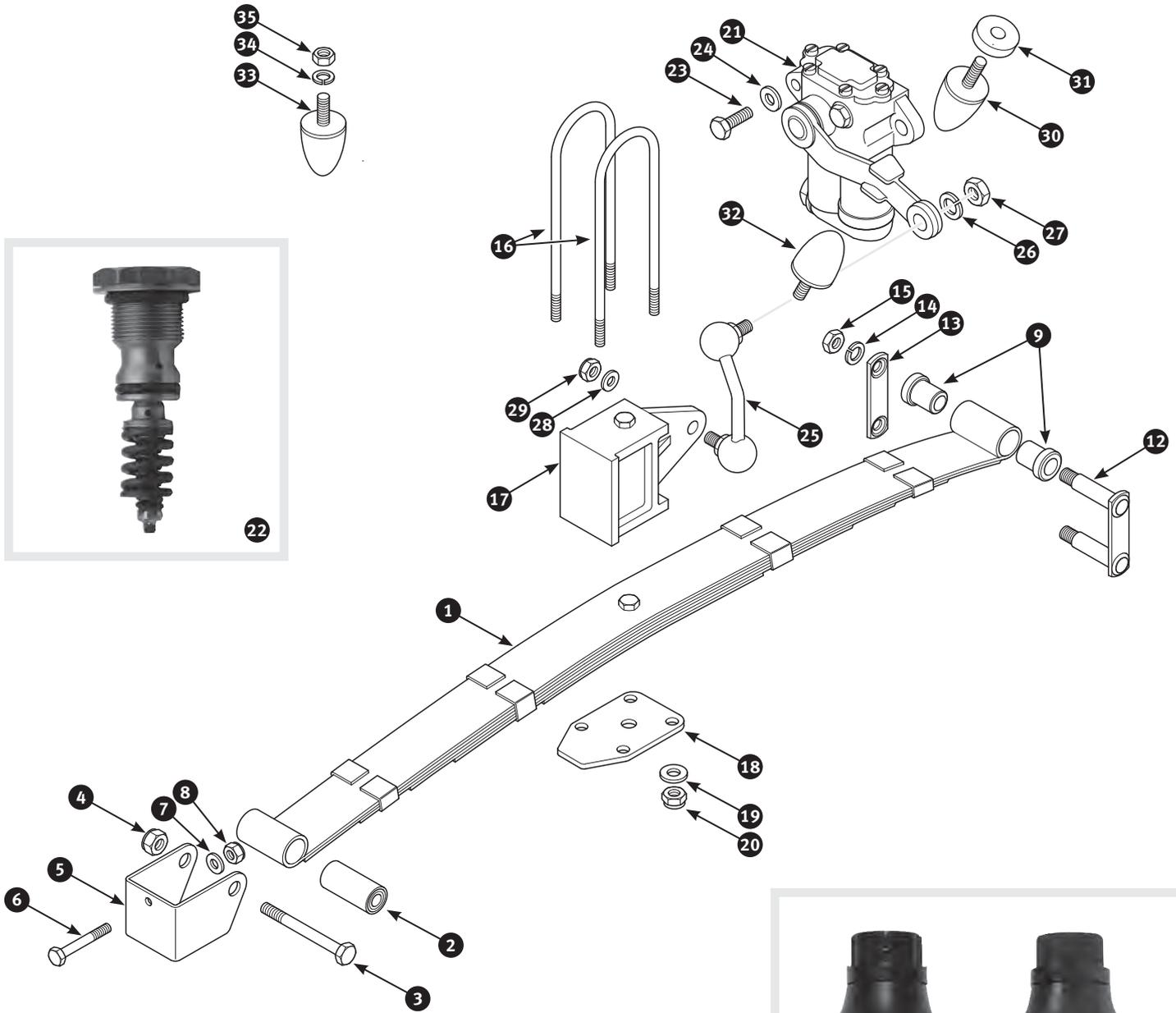

No	Part No	Description	Qty	Notes
1	15345	Leaf spring	2	
2	201054	Bush leaf spring, front eye	4	
3	19393	Bolt bush front eye spring	2	
4	3785	Nyloc nut	2	
5	484482	Bracket RH leaf spring, front eye - new item	1	
5	200268	Bracket RH leaf spring, front eye - used item	1	
5	484481	Bracket LH leaf spring, front eye - new item.	1	
5	200269	Bracket LH leaf spring, front eye - used item	1	
6	213892	Bolt leaf spring bracket to frame.	4	
7	9671	Plain washer	4	
8	2829	Nyloc nut	4	
9	245	Rubber bush leaf spring, rear shackle	8	} Alternatives
10	313452	Polyurethane bush leaf spring, rear shackle	8	
11	13034	Nylatron bush leaf spring, rear shackle	8	
12	11925	Shackle leaf spring, rear attachment	2	
13	17202	Shackle plate	2	
14	2051	Spring washer	4	
15	3073	Nut	4	
16	2396	,U' bolt leaf spring.	4	
17	15457	Spacer block leaf spring - new item.	2	
17	204089	Spacer block leaf spring - used item	2	
18	338802	Mounting plate leaf spring - new item	2	
18	200351	Mounting plate leaf spring - used item	2	
19	212195	Plain washer	8	
20	2829	Nyloc nut	8	
21	15730	Shock absorber RH - new item	1	} For telescopic shock absorber conversion see chapter 21.16
21	15729	Shock absorber LH - new item	1	
21	315345	Shock absorber RH - exchange	1	
21	315344	Shock absorber LH - exchange	1	
21	326288	Shock absorber RH - new item. 25% uprated version	1	
21	326287	Shock absorber LH - new item. 25% uprated version	1	
21	20858	Shock absorber RH - exchange. 25% uprated version	1	
21	20857	Shock absorber LH - exchange. 25% uprated version	1	
22	15826	Shock absorber valve 25% uprated - to fit to your own unit	2	
23	10753	Screw shock absorber to frame.	4	
24	9668	Plain washer	4	
25	11674	Connection link RH shock absorber.	1	
25	9888	Connection link LH shock absorber	1	
26	2215	Spring washer	2	
27	2869	Nut link to shock absorber.	2	
28	212195	Plain washer	2	
29	212113	Nyloc nut link to spacer block.	2	
30	1259	Bump stop rubber on body	2	
31	300690	Distance piece bump stop rubber	2	
32	1259	Bump stop rubber on chassis	2	
33	201068	Bump stop rubber on axle tube	2	
34	2051	Spring washer	2	
35	3073	Nut	2	
36	373933	Penrite Damper oil no.1, replaces following oil: SAE 20W - 500 ml bottle	1	} Please find further oils and lubricants in chapter 21.31
36	305185	Penrite Damper oil no.2,, replaces following oil: SAE 20W - 500 ml bottle	1	

11.4

Rear suspension

Suspension and shock absorber - TR4A IRS

Cars with independent rear suspension

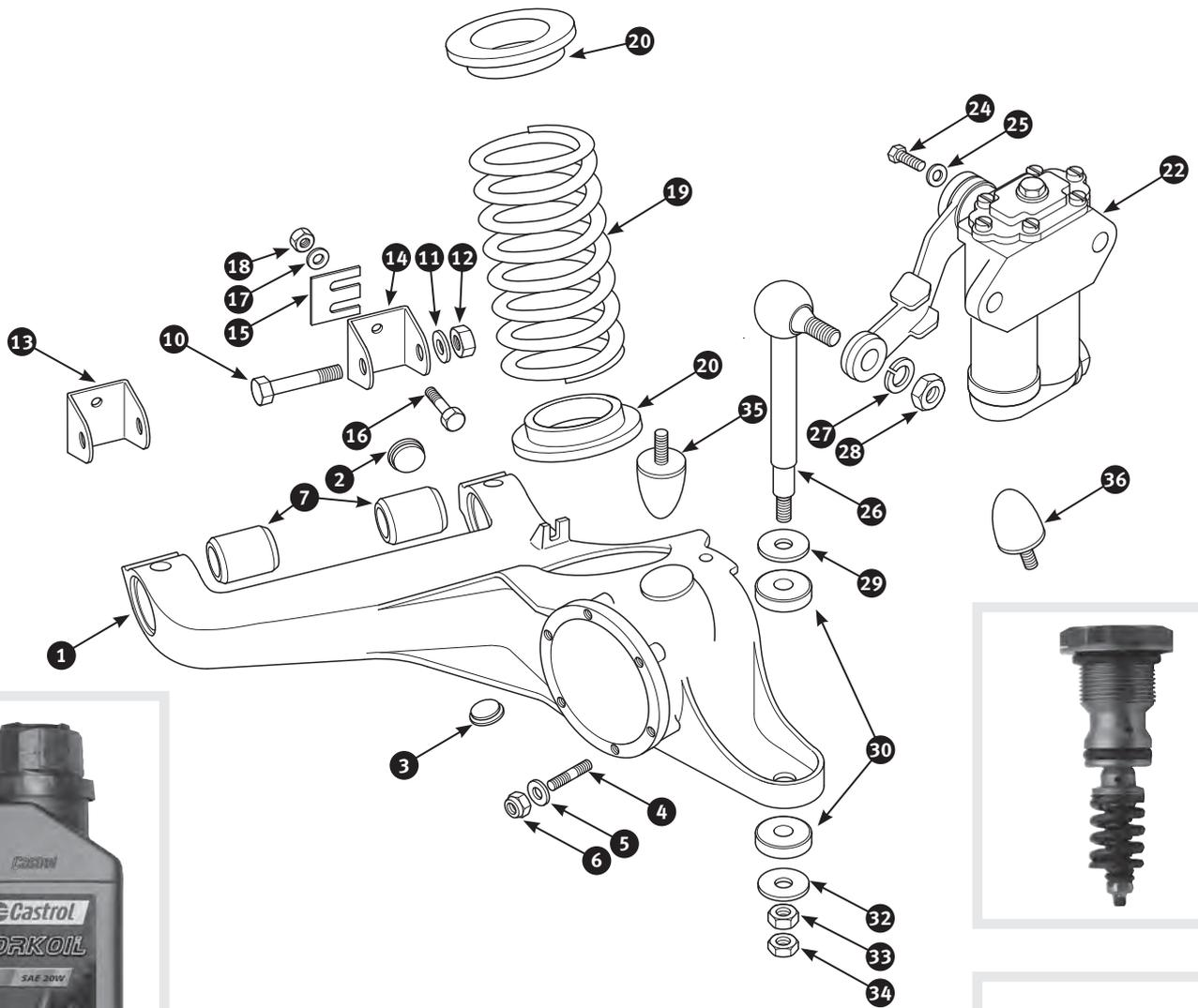

No	Part No	Description	Qty	Notes
1	316296	Trailing arm RH, new item	1	
1	316293	Trailing arm RH, used item	1	
1	316297	Trailing arm LH, new item.	1	
1	316294	Trailing arm LH, used item	1	
2	1327	Rubber plug trailing arm - diameter 1.1/8"	4	
3	19424	Rubber plug trailing arm - diameter: 7/8"	4	
4	5340	Stud hub unit to trailing arm	12	
5	212193	Plain washer hub unit to trailing arm.	12	
6	2049	Nyloc nut hub unit to trailing arm	12	
7	1256	Rubber bush trailing arm	4	} Alternatives
8	25796	Polyurethane bush trailing ram	4	
9	12814	Nylatron bush trailing arm	4	
10	7549	Bolt trailing arm to bracket.	4	
11	212195	Plain washer	4	
12	2049	Nyloc nut	4	
13	9724	Bracket trailing arm outer.	2	} Identification: 2 notches
14	9725	Bracket trailing arm inner.	2	
15	9758	Packing plate bracket to frame	0	} Quantity as required
16	6540	Bolt bracket to frame.	4	
17	10739	Plain washer	4	
18	2049	Nyloc nut	4	
19	19043	Coil spring - standard height, spring rate: 320 lbs/in.	2	} For further coil springs see chapter 21.16
19	2765	Coil spring - standard height, spring rate: 420 lbs/in.	2	
20	200	Mounting plate spring insulator	4	} Alternatives
21	317895	Polyurethane pad spring insulator.	4	
22	15730	Shock absorber RH - new item	1	} For telescopic shock absorber conversion see chapter 21.16
22	15729	Shock absorber LH - new item	1	
22	315345	Shock absorber RH - exchange	1	
22	315344	Shock absorber LH - exchange	1	
22	326288	Shock absorber RH - new item. 25% uprated version	1	
22	326287	Shock absorber LH - new item. 25% uprated version	1	
22	20858	Shock absorber RH - exchange. 25% uprated version	1	
22	20857	Shock absorber LH - exchange. 25% uprated version	1	
23	15826	Shock absorber valve 25% uprated - to fit to your own unit	2	
24	10753	Screw shock absorber to frame.	4	
25	9668	Plain washer	4	
26	16206	Connection link shock absorber	2	
27	2215	Spring washer	2	
28	2869	Nut link to shock absorber.	2	
29	9760	Plain washer - upper	2	
30	12361	Rubber bush link to trailing arm	4	} Alternatives
31	317093	Polyurethane bush link to trailing arm	4	
32	9857	Plain washer - lower	2	
33	3073	Nut link to trailing arm.	2	
34	7739	Nut locking.	2	
35	1259	Bump stop rubber on wheel arch	2	
36	201068	Bump stop rubber on chassis.	2	
37	200318	Castrol Damper oil SAE 20W - 500 ml bottle	1	} Please find further oils and lubricants in chapter 21.31

11.5

Rear suspension

Solid axle Lockheed type - TR2, TR3 to TS13045

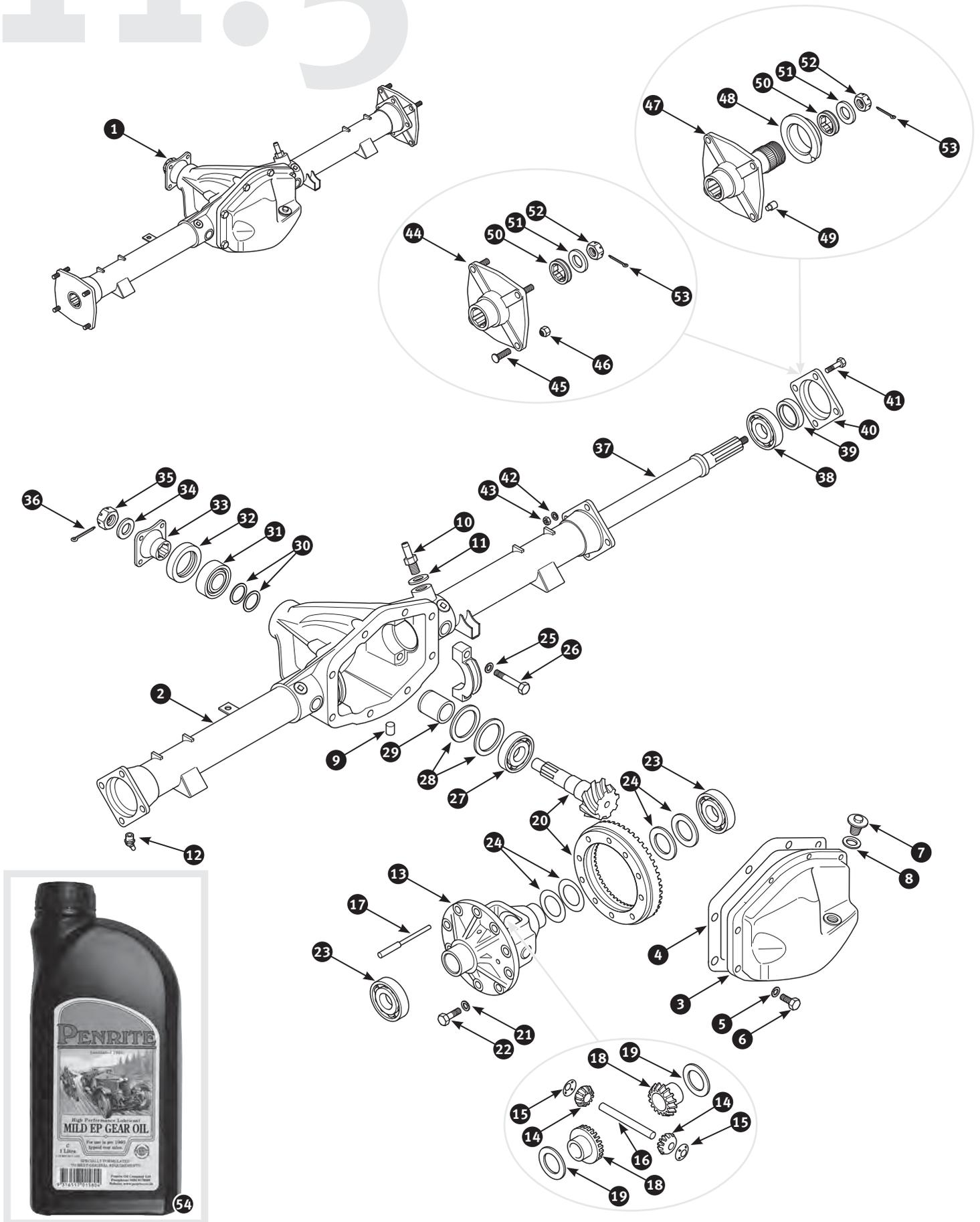

No	Part No	Description	Qty	Notes
1	319439	Rear axle exchange ratio: 3.7:1	1	
2	300630	Axle casing	1	
3	300696	Cover	1	
4	4735	Gasket rear axle cover	1	
5	212194	Spring washer	8	
6	212162	Screw cover to axle	8	
7	300626	Filler plug rear cover	1	
8	11507	Fibre washer	1	
9	300623	Oil drain plug	1	
10	450187	Breather axle casing	1	
11	11442	Fibre washer	1	
12	5469	Grease nipple	2	
13	300250	Differential carrier	1	
14	293883	Planet gear differential	2	
15	5015	Thrust washer 0.051" - 0.053"	0	} Quantity as required
15	5017	Thrust washer 0.055" - 0.057"	0	
15	9591	Thrust washer 0.059" - 0.061"	0	
15	9592	Thrust washer 0.063" - 0.065"	0	
15	2092	Thrust washer 0.065" - 0.067"	0	
15	9593	Thrust washer 0.067" - 0.069"	0	
15	5014	Thrust washer 0.071" - 0.073"	0	
16	214	Shaft planet gears	1	
17	5095	Locating pin shaft to differential carrier	1	
18	217	Sun gear differential	2	
19	5043	Thrust washer sun gear	2	} Always replace in pairs
20	365	Crown wheel and pinion with 3.70:1 ratio	1	
20	289873	Crown wheel and pinion with 4.10:1 ratio	1	
21	2051	Spring washer	10	
22	5092	Bolt crown wheel to differential carrier	10	
23	239	Ball bearing differential carrier	2	
24	15191	Shim 0.003"	0	} Quantity as required
24	5036	Shim 0.005"	0	
24	214088	Shim 0.010"	0	
25	2051	Spring washer	4	
26	215	Bolt bearing cap to axle casing	4	
27	3036	Ball bearing pinion, rear	1	
28	5038	Shim 0.003"	0	} Quantity as required
28	5039	Shim 0.005"	0	
28	2040	Shim 0.010"	0	
29	9736	Distance tube between pinion bearings	1	



11.5

Rear suspension

Solid axle Lockheed type - TR2, TR3 to TS13045

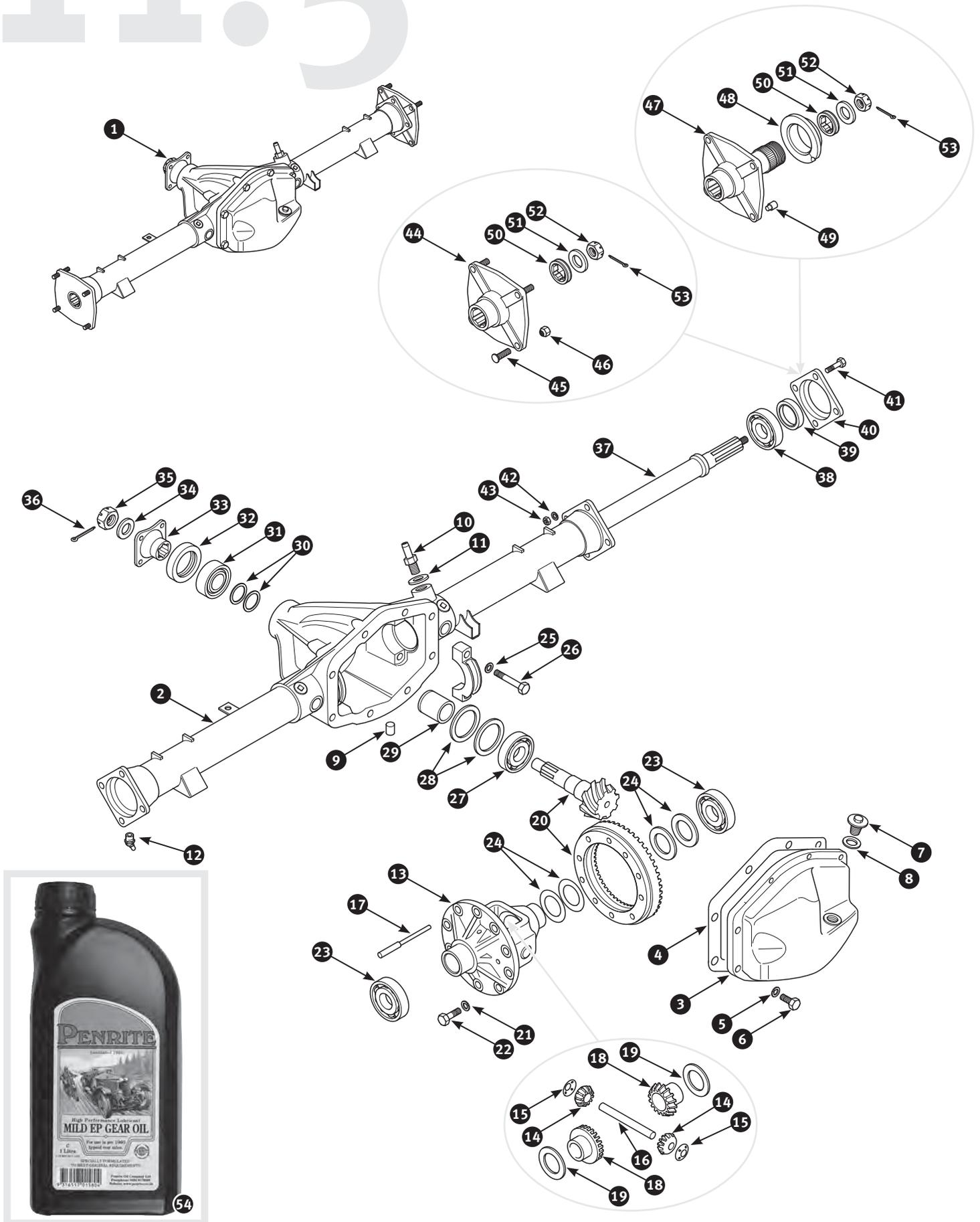

No	Part No	Description	Qty	Notes
30	9761	Shim 0.003"	0	} Quantity as required
30	9720	Shim 0.005"	0	
30	9719	Shim 0.010"	0	
31	209	Ball bearing pinion, front	1	
32	194	Oil seal differential pinion	1	
33	290249	Flange propshaft - square type	1	} Original type } May replace original flange but need some modification
33	291028	Flange propshaft	1	
34	9762	Plain washer	1	
35	11450	Slotted nut flange to pinion	1	} Alternatives
35	315371	Nyloc nut flange to pinion	1	
36	7464	Split pin on slotted nut	1	
37	2004	Half shaft	2	
38	3935	Ball bearing rear hub	2	
39	1847	Oil seal rear hub	2	} TR2 to TS5555 } TR2 from TS5556, TR3
39	1689	Oil seal rear hub	2	
40	300695	Housing wheel bearing	2	
41	4893	Bolt housing to axle casing	8	
42	212195	Plain washer	8	
43	2829	Nyloc nut	8	
44	300652	Hub	2	} Vehicles fitted with disc wheels
45	193	Wheel stud	8	
46	4983	Wheel nut	8	
47	300650	Wire wheel hub LH	1	} Vehicles fitted with wire wheels
47	300651	Wire wheel hub RH	1	
48	2003	Distance collar	2	
49	290196	Peg brake drum to hub - short	6	
49	300649	Dowel brake drum to hub - long	2	
50	300647	Collar rear hub - internally splined	2	
51	212198	Plain washer	2	
52	9675	Slotted nut rear hub to half shaft	2	
53	3269	Split pin on slotted nut	2	
54	212132	Penrite Gear oil Mild EP - 1 litre bottle	1	} Please find further oils and lubricants in chapter 21.31



Limited slip differential

A direct replacement for the standard differential, the limited slip differential transforms your car's performance. Unlike a conventional plate-style limited slip differential, this differential relies on gears rather than clutch plates for its operation. That means it is much smoother in operation. This differential type never locks harshly with a set pre-load of wheel slip across the driven axle, like a conventional LSD. Rather, the differential automatically biases the torque away from the spinning wheel across the axle, to a constantly varying degree, and never locks.

Part no. 17683

11.6

Rear suspension

Solid axle Girling type - TR3 from TS13046, TR3A, TR3B, TR4 and TR4A

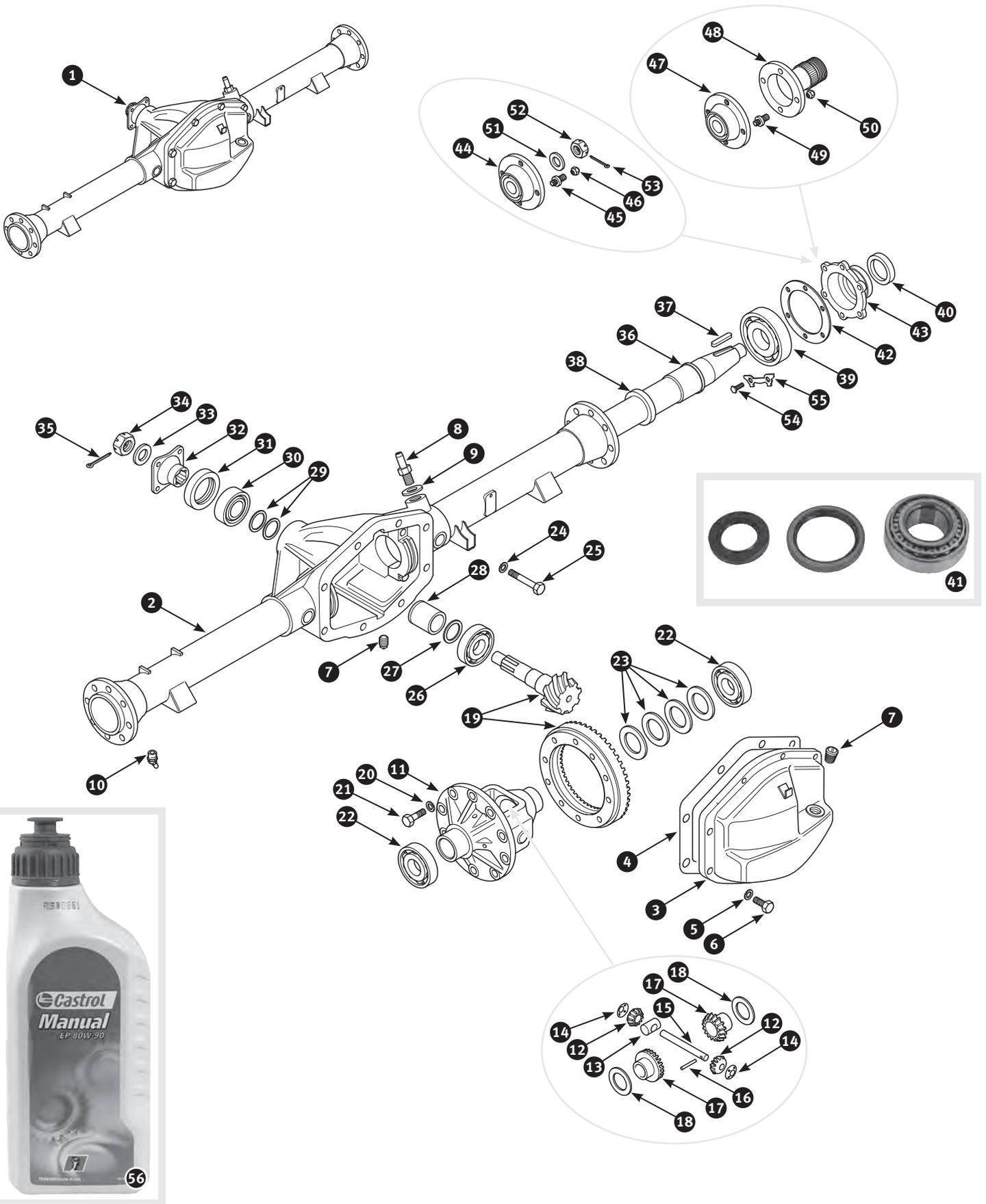

No	Part No	Description	Qty	Notes
1	319438	Rear axle exchange	1	} TR3, TR3A and TR3B - axle ratio: 3.7:1
1	478639	Rear axle with new crown wheel and pinion - exchange	1	
1	304856	Rear axle exchange	1	} TR4 - axle ratio: 3.7:1
1	478643	Rear axle with new crown wheel and pinion - exchange	1	
1	319440	Rear axle exchange	1	} TR4 - axle ratio: 4.1:1
1	290741	Rear axle with new crown wheel and pinion - exchange	1	
1	214922	Rear axle exchange	1	} TR4A - axle ratio: 3.7:1
1	394514	Rear axle with new crown wheel and pinion - exchange	1	
1	214924	Rear axle exchange	1	} TR4A - axle ratio: 4.1:1
1	336729	Rear axle with new crown wheel and pinion - exchange	1	
2	300721	Axle casing	1	
3	297750	Cover rear axle - original type.	1	
3	324535	Cover rear axle - aluminium	1	} May replace original cover 297750
4	4735	Gasket rear axle cover	1	
5	212194	Spring washer	8	
6	212162	Screw cover to axle	8	
7	14245	Blanking plug oil drain and oil filler	2	
8	450187	Breather axle casing.	1	
9	11442	Fibre washer	1	
10	5139	Grease nipple	2	
11	14937	Differential carrier	1	
12	308	Planet gear differential - 10 teeth	2	
13	5090	Thrust block planet gears.	1	
14	5015	Thrust washer 0.051" - 0.053"	2	
14	5017	Thrust washer 0.055" - 0.057"	2	
14	9591	Thrust washer 0.059" - 0.061"	2	
14	9592	Thrust washer 0.063" - 0.065"	2	
14	2092	Thrust washer 0.065" - 0.067"	2	
14	9593	Thrust washer 0.067" - 0.069"	2	
14	5014	Thrust washer 0.071" - 0.073"	2	
15	214	Shaft planet gears.	1	
16	5095	Locating pin shaft to differential carrier	1	
17	11638	Sun gear differential - 16 teeth	2	
18	5043	Thrust washer sun gear	2	} Always replace in pairs
19	365	Crown wheel and pinion with 3.70:1 ratio	1	
19	289873	Crown wheel and pinion with 4.10:1 ratio.	1	
20	2051	Spring washer	10	
21	5092	Bolt crown wheel to differential carrier	10	
22	239	Ball bearing differential carrier	2	
23	15191	Shim 0.003"	0	} Quantity as required
23	5036	Shim 0.005"	0	
23	214088	Shim 0.010"	0	
24	2051	Spring washer	4	
25	215	Bolt bearing cap to axle casing.	4	
26	3036	Ball bearing pinion, rear.	1	
27	5038	Shim 0.003"	0	} Quantity as required
27	5039	Shim 0.005"	0	
27	2040	Shim 0.010"	0	
28	9736	Distance tube between pinion bearings	1	
29	316581	Shim 0.003"	0	} Quantity as required
29	316582	Shim 0.005"	0	
29	316583	Shim 0.010"	0	

11.6

Rear suspension

Solid axle Girling type - TR3 from TS13046, TR3A, TR3B, TR4 and TR4A

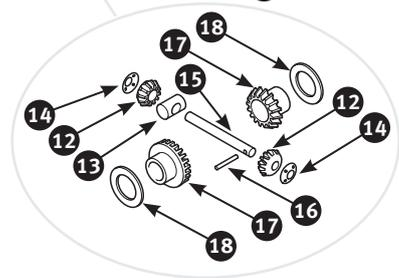
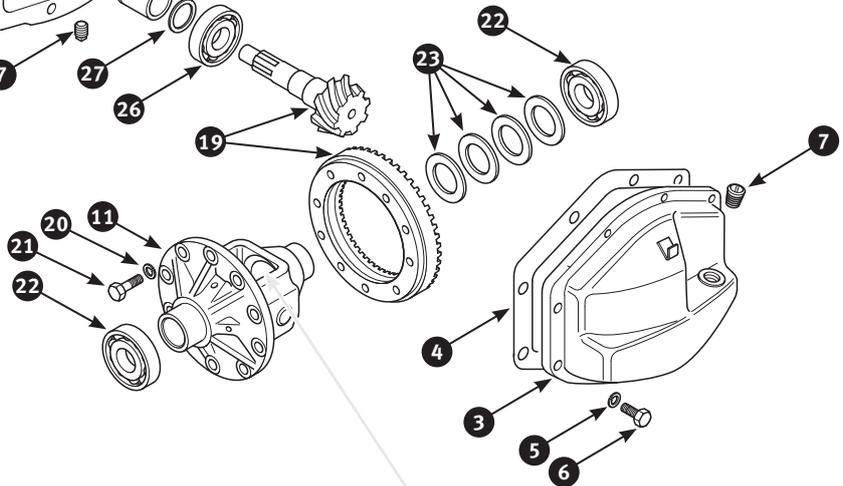
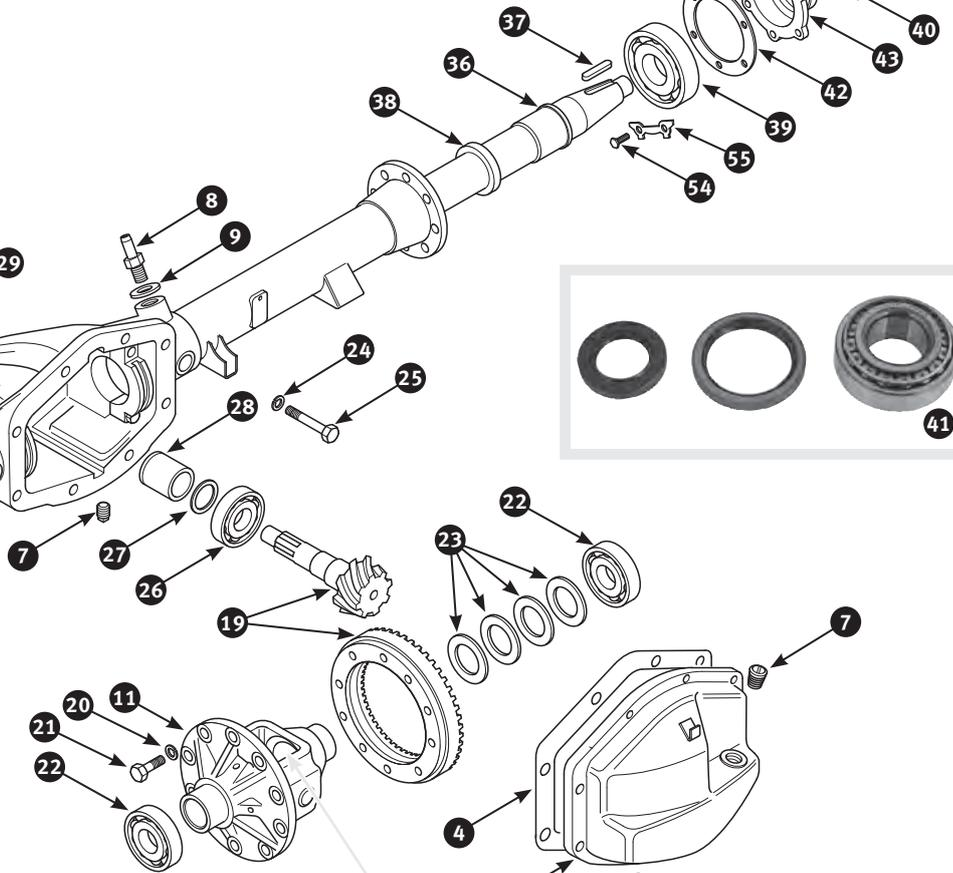
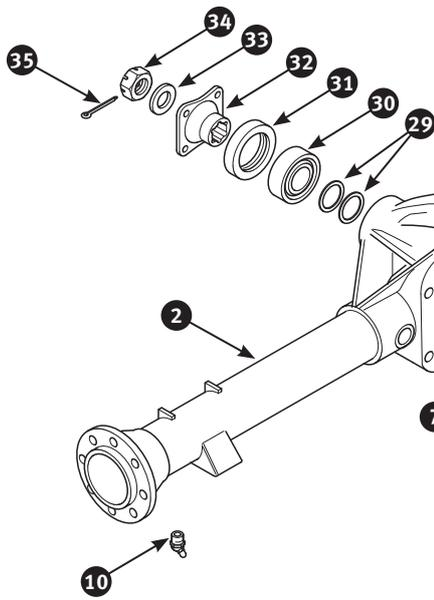
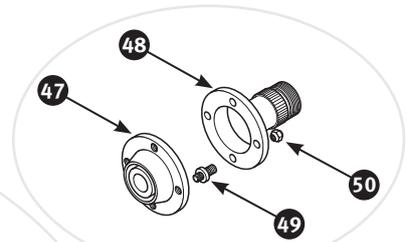
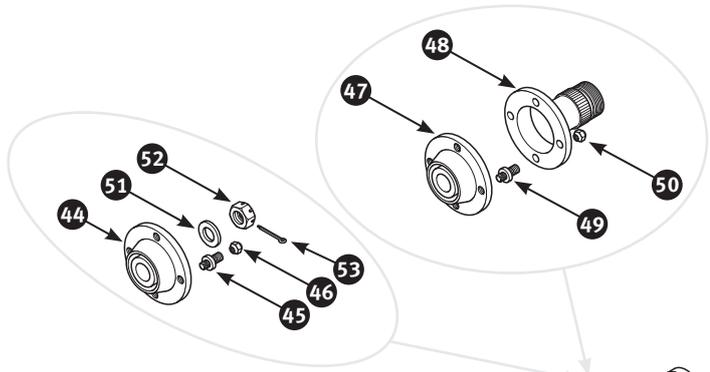
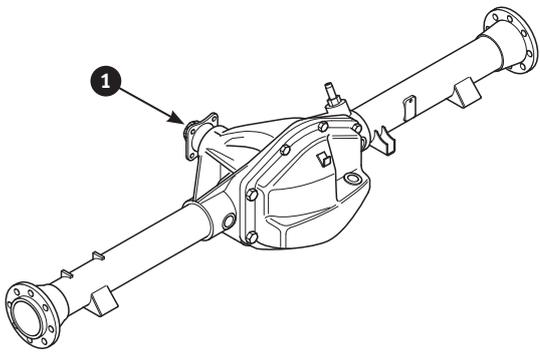

No	Part No	Description	Qty	Notes
30	209	Ball bearing pinion, front	1	
31	194	Oil seal differential pinion	1	} TR3, TR3A, TR3B and TR4
31	282	Oil seal differential pinion	1	
32	290249	Flange propshaft - square type	1	} TR3, TR3A, TR3B and TR4
32	300889	Flange propshaft - round type.	1	
32	291028	Flange propshaft - round type.	1	} May replace original flange but need some modification
33	9762	Plain washer	1	
34	9675	Slotted nut securing flange on pinion	1	
35	7464	Split pin on slotted nut	1	
36	347155	Half shaft	2	} TR3, TR3A and TR3B
36	204004	Half shaft	2	
37	9589	Woodruff key securing rear hub	2	
38	1035	Oil seal axle housing	2	
39	1018	Tapered roller bearing hub	2	
40	1031	Oil seal hub	2	
41	1024	Wheel bearing kit	2	
42	3331	Shim 0.006"	0	} Quantity as required
42	3333	Shim 0.008"	0	
42	3314	Shim 0.015"	0	
42	3313	Shim 0.030"	0	
43	339124	Housing wheel bearing.	2	
44	316550	Hub	2	} Vehicles fitted with disc wheels
45	193	Wheel stud	8	
46	4983	Wheel nut	8	
47	316550	Hub	2	} Vehicles fitted with wire wheels
48	342	Wire wheel hub RH	1	
48	343	Wire wheel hub LH	1	
49	1253	Wheel stud	8	
50	1254	Steel nut	8	
51	212198	Plain washer	2	
52	3405	Slotted nut rear hub to half shaft	2	
53	7466	Split pin on slotted nut	2	
54	5098	Bolt bearing housing to axle casing.	12	
55	9843	Lock tab	6	
56	290203	Castrol Gearbox oil for rear axle, EP90 - 1 litre bottle	1	} Please find further oils and lubricants in chapter 21.31



Grease tape
to seal body parts and frame connections
or wrap around leaf springs. Roll with 10
meters, 50 mm wide
Part no. 342655

11.7

Rear suspension

IRS axle - TR4A

Cars with independent rear suspension

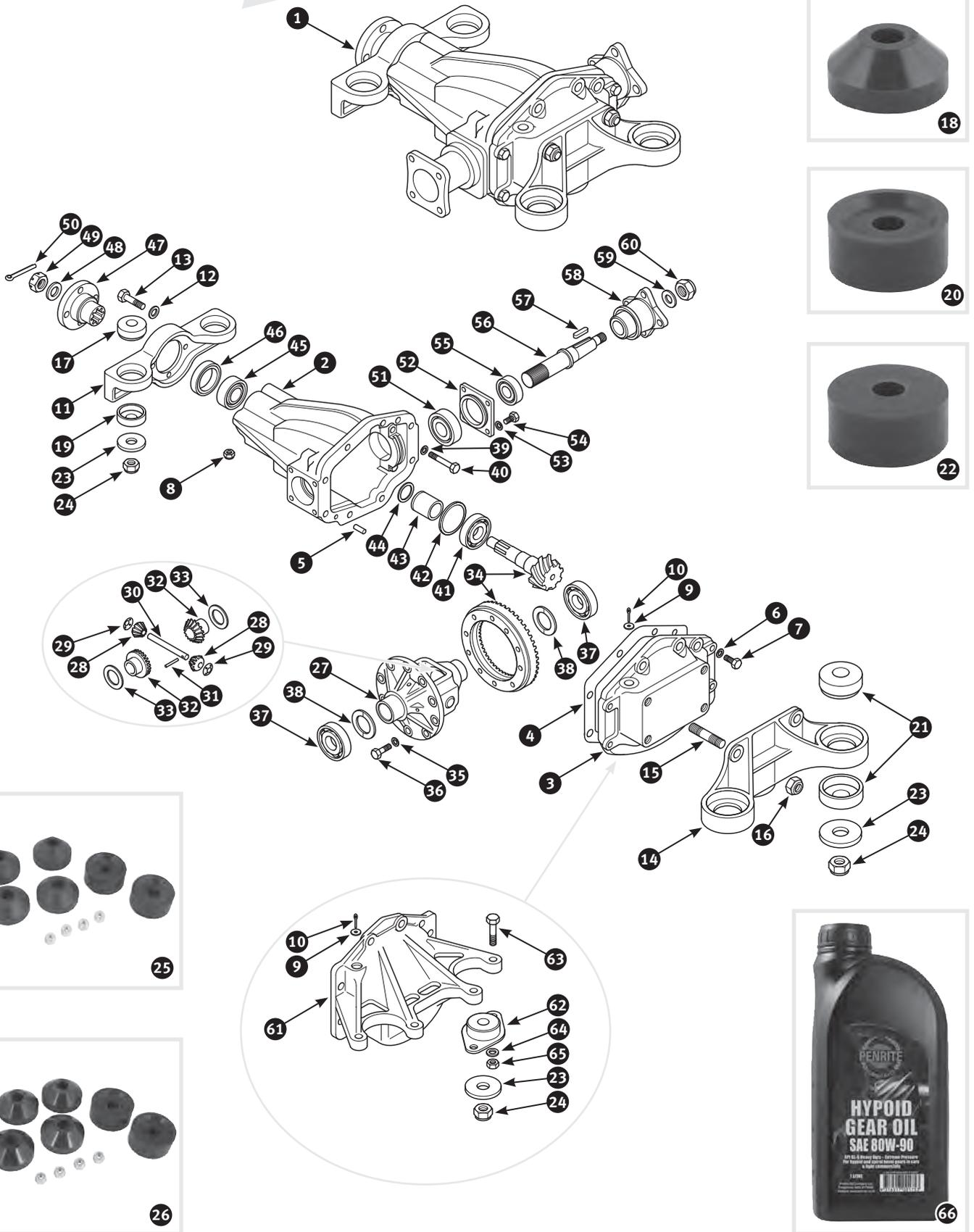



No	Part No	Description	Qty	Notes
1	327453	Differential exchange	1	Ratio: 3.7:1
1	321095	Differential with new crown wheel and pinion - exchange	1	
1	448877	Differential exchange	1	Ratio: 4.1:1
1	448878	Differential with new crown wheel and pinion - exchange	1	
2	300706	Housing differential	1	
3	302962	Cover differential - new item	1	
3	212627	Cover differential - used item	3	
4	9692	Gasket differential cover	1	
5	4910	Pin differential cover	2	
6	212194	Spring washer	8	
7	2826	Screw cover to differential housing	8	
8	14245	Blanking plug oil filler	1	
9	14280	Plug differential breather	1	An 1/8" breather hole must be drilled into the plug
10	3269	Split pin for differential breather plug	1	
11	202141	Bracket differential, front mounting	1	
12	209117	Shakeproof washer	4	
13	11590	Screw bracket to differential housing	4	
14	319363	Bracket differential, rear mounting - new item	1	
14	212626	Bracket differential, rear mounting - used item	1	
15	9764	Stud bracket to differential cover	4	
16	2829	Nyloc nut	4	
17	201067	Rubber bush front upper differential mount	2	Alternatives
18	25792	Polyurethane bush front upper differential mount	2	
19	199	Rubber bush front lower differential mount	2	Alternatives
20	25793	Polyurethane bush front lower differential mount	2	
21	201067	Rubber bush rear differential mount	4	Alternatives
22	25792	Polyurethane bush rear differential mount	4	
23	272	Packing washer differential mount	4	
24	2829	Nyloc nut differential mount	4	
25	294285	Bush kit differential mounting - rubber	1	
26	294286	Polyurethane bush kit differential mounting	1	
27	14937	Differential carrier	1	
28	308	Planet gear differential - 10 teeth	2	
29	5015	Thrust washer 0.051" - 0.053"	0	Quantity as required
29	5017	Thrust washer 0.055" - 0.057"	0	
29	9591	Thrust washer 0.059" - 0.061"	0	
29	9592	Thrust washer 0.063" - 0.065"	0	
29	2092	Thrust washer 0.065" - 0.067"	0	
29	9593	Thrust washer 0.067" - 0.069"	0	
29	5014	Thrust washer 0.071" - 0.073"	0	
30	214	Shaft planet gears	1	
31	5095	Locating pin differential pinion shaft	1	
32	11638	Sun gear differential - 16 teeth	2	
33	5043	Thrust washer sun gear	2	Always replace in pairs
34	289873	Crown wheel and pinion with 4.10:1 ratio	1	
34	365	Crown wheel and pinion with 3.70:1 ratio	1	Alternatives
34	2463	Crown wheel and pinion with 3.45:1 ratio	1	
35	2051	Spring washer	10	
36	5092	Bolt crown wheel to differential carrier	10	
37	239	Ball bearing differential carrier	2	
38	15191	Shim 0.003"	0	Quantity as required
38	5036	Shim 0.005"	0	
38	214088	Shim 0.010"	0	
39	2051	Spring washer	4	
40	215	Bolt bearing cap to differential casing	4	
41	3036	Ball bearing pinion, rear	1	
42	5038	Shim 0.003"	0	Quantity as required
42	5039	Shim 0.005"	0	
42	2040	Shim 0.010"	0	

11.7

Rear suspension

IRS axle - TR4A

Cars with independent rear suspension

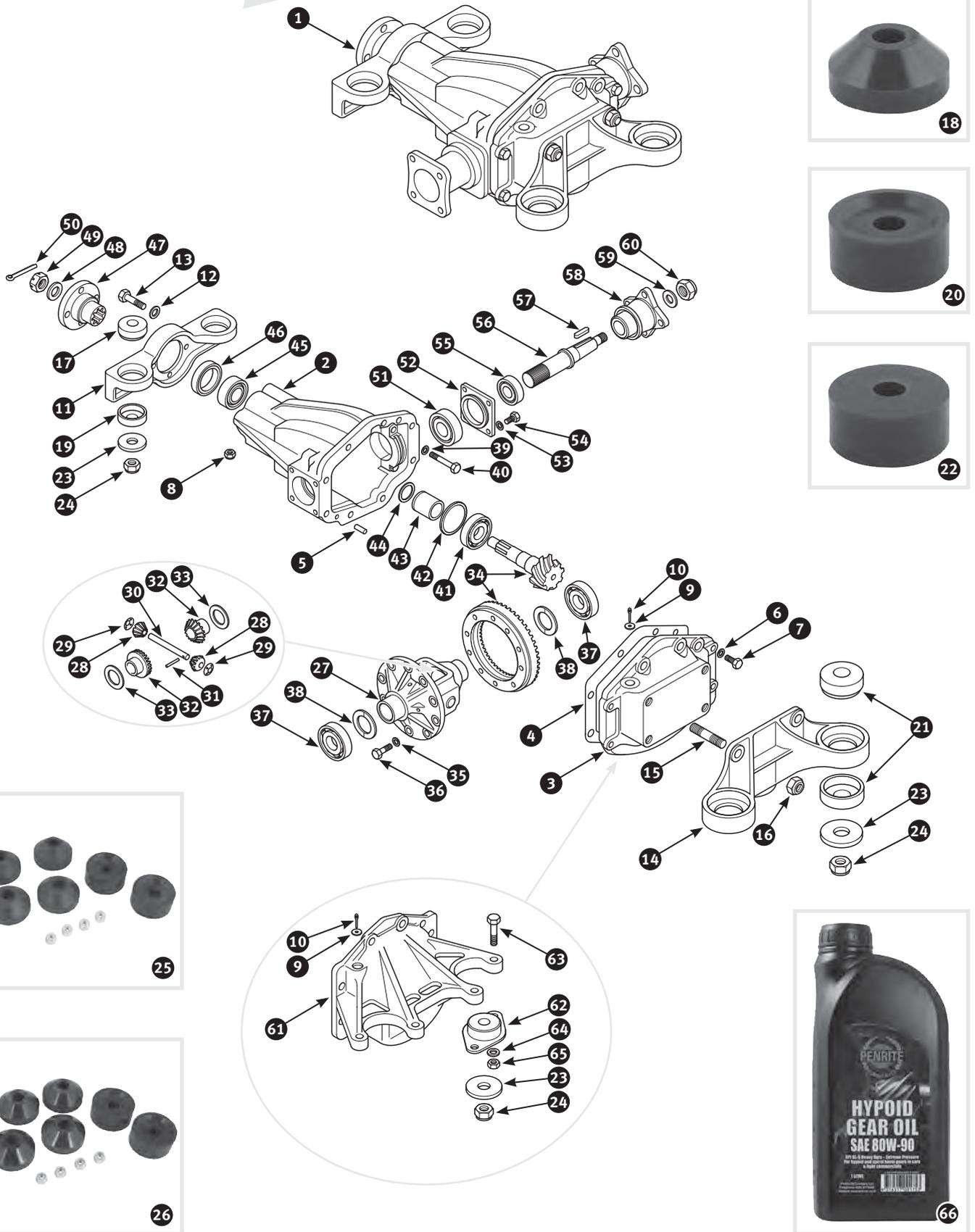

No	Part No	Description	Qty	Notes
43	9736	Distance tube between pinion bearings	1	
44	316581	Shim 0.003"	0	Quantity as required
44	316582	Shim 0.005"	0	
44	316583	Shim 0.010"	0	
45	209	Ball bearing pinion, front	1	
46	282	Oil seal differential pinion	1	
47	300889	Flange propshaft - original type	1	May replace original flange but need some modification
47	291028	Flange propshaft	1	
48	9762	Plain washer	1	
49	9675	Slotted nut securing flange on pinion	1	
50	18488	Split pin on slotted nut	1	
51	273	Ball bearing half shaft	2	
52	14503	Bearing housing	2	
53	212194	Spring washer	8	
54	7893	Screw bearing housing to differential casing.	8	
55	276	Oil seal half shaft	2	
56	290226	Half shaft RH.	1	
56	300679	Half shaft LH.	1	
57	300684	Woodruff key securing half shaft flange	2	
58	300685	Flange half shaft	2	
59	9762	Plain washer output flange.	2	
60	9701	Nyloc nut output flange	2	
61	14056	Cover differential - used item	1	TR6 variant - may replace original cover and bracket
61	324536	Cover differential - made from aluminium.	1	
61	337533	Cover differential - made from magnesium.	2	
62	201077	Mounting differential rear.	2	
63	6522	Bolt differential mounting to cover	4	
64	212193	Plain washer	4	
65	2829	Nyloc nut	4	
66	485836	Penrite Gear oil Hypoid 80W/90 - 1 litre bottle	2	Please find further oils and lubricants in chapter 21.31

Drive shaft
 complete with wheel hub - improved
 version with constant velocity joints and
 ball bearing sliding shafts
 Part no. 323905



11.8

Rear suspension

Drive shaft - TR4A IRS

Cars with independent rear suspension

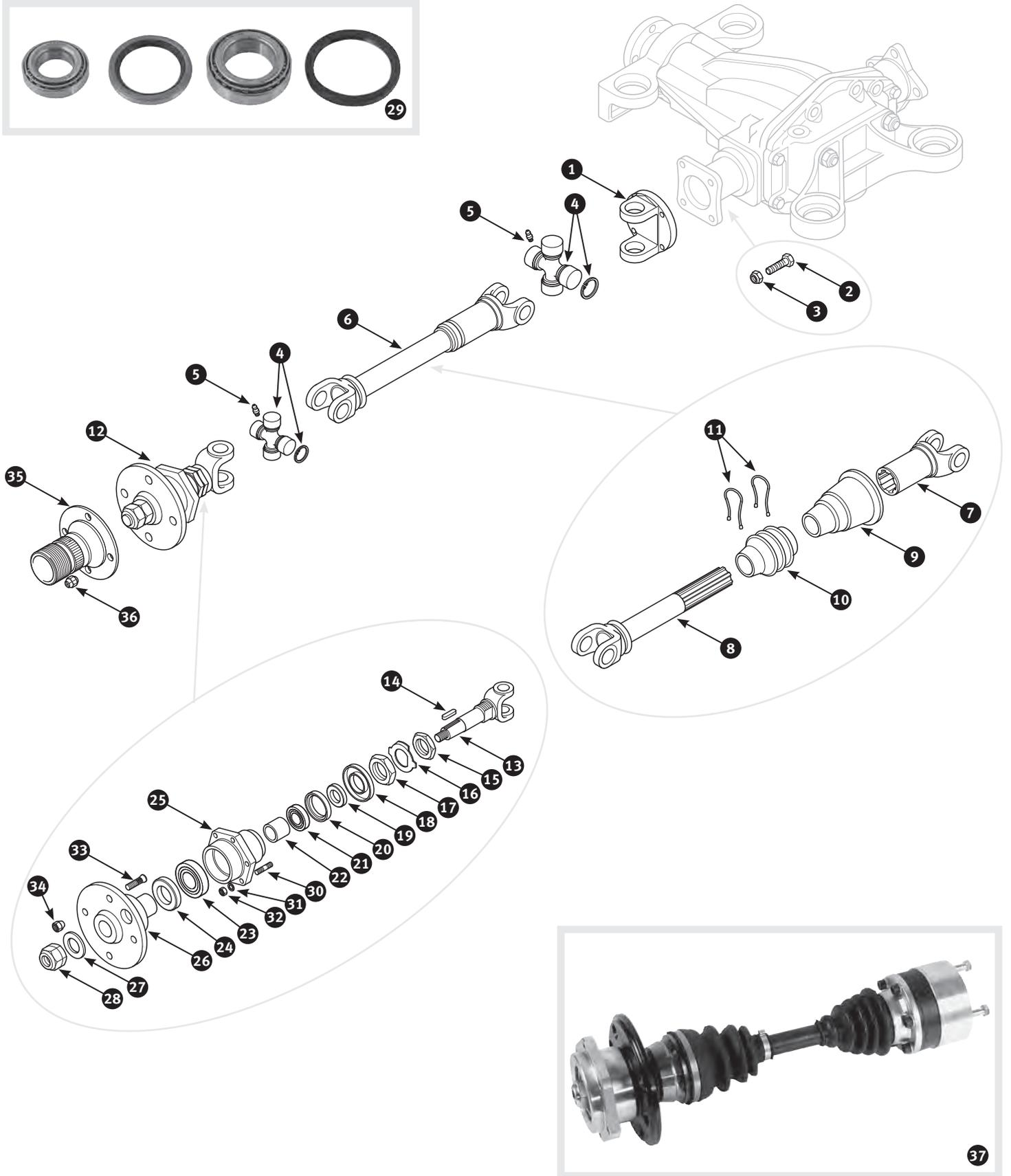

No	Part No	Description	Qty	Notes
1	205237	Flange drive shaft	2	
2	4893	Bolt drive shaft to differential	8	
3	2829	Nyloc nut	8	
4	7528	Universal joint - non greaseable	4	} Alternatives
4	1868	Universal joint - greaseable	4	
5	202302	Grease nipple for greaseable universal joints	4	
6	1548	Drive shaft regular version	2	} Alternatives
6	479611	Drive shaft uprated version	2	
7	9718	Slip joint drive shaft - inner	2	
8	479588	Sliding shaft drive shaft - outer	2	
9	4054	Gaiter inner joint	2	
10	207714	Rubber gaiter drive shaft	2	
11	4869	Lock wire on rubber gaiter	4	
12	348186	Hub unit assembly - new item	2	} Alternatives
12	2442	Hub unit assembly - exchange	2	
13	10117	Shaft hub unit	2	
14	9589	Woodruff key	2	
15	9752	Nut locking	2	
16	9713	Lock tab	2	
17	9711	Adjusting nut wheel bearing	2	
18	9695	Stoneguard	2	
19	10163	Distance collar	2	
20	1490	Oil seal rear hub - inner	2	
21	1014	Ball bearing rear hub - inner	2	
22	9698	Distance tube between wheel bearings	2	
23	1020	Ball bearing rear hub - outer	2	
24	1028	Oil seal rear hub - outer	2	
25	200257	Housing rear hub	2	
26	339238	Hub	2	} Vehicles fitted with wire wheels } Vehicles fitted with disc wheels
26	102	Hub	2	
27	9672	Plain washer	2	
28	9701	Nyloc nut hub to shaft	2	
29	1944	Wheel bearing kit	2	} Comprising illustration no.'s 20 to 24
30	5340	Stud hub unit to trailing arm	12	
31	212193	Plain washer	12	
32	7455	Nyloc nut	12	
33	1265	Wheel stud	8	} Vehicles fitted with wire wheels
33	9688	Wheel stud	8	
34	4983	Wheel nut	8	} Vehicles fitted with disc wheels
35	342	Wire wheel hub RH	1	
35	343	Wire wheel hub LH	1	} Vehicles fitted with wire wheels
36	1254	Steel nut	8	
37	323905	Drive shaft complete with hub unit - improved version with constant velocity joints and ball bearing sliding shafts	2	} For further information see chapter 21.16

Order free of charge:

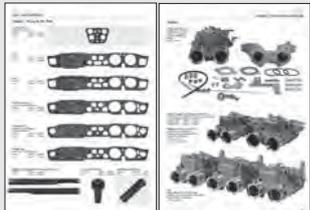

Tuning catalogue

Order free of charge:



Accessories catalogue

11.9

Rear suspension Propshaft

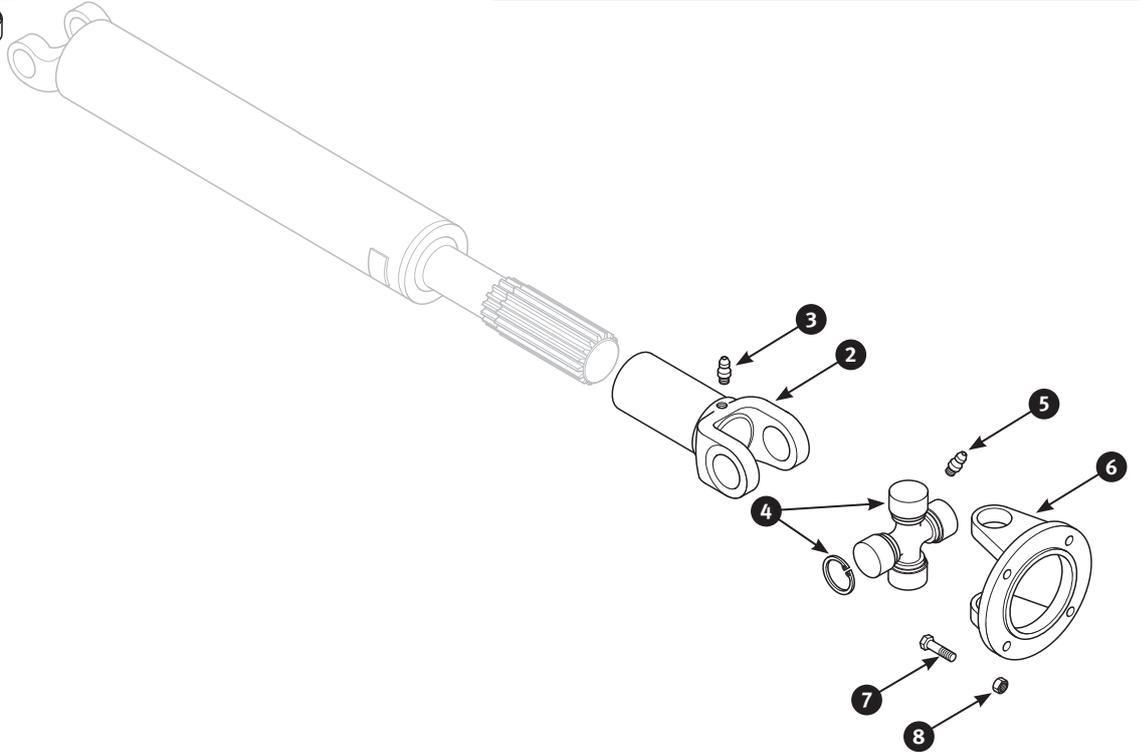
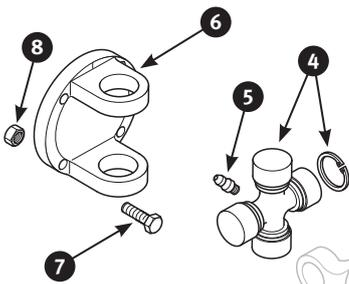

No	Part No	Description	Qty	Notes
1	9541	Propshaft new	1	
2	21194	Sleeve yoke propshaft	1	
3	10938	Grease nipple propshaft yoke	1	
4	1868	Universal joint - greaseable	2	} Alternatives
4	7528	Universal joint - non greaseable	2	
5	202302	Grease nipple for greaseable universal joints	2	
6	205237	Flange propshaft	2	
7	4893	Bolt propshaft to gearbox and to differential	8	
8	212110	Nyloc nut	8	} Alternatives
8	3788	Steel nut self locking	8	
9	339353	Universal joint kit for propshaft and both drive shafts	1	TR4A IRS
10	296178	Grease gun for 400g. standard grease cartridges	1	



Joint cleaning tool
 saves grease joints, renovates King Pins.
 Quality 1144 steel construction with
 extension. Lifetime warranty.
 Part no.245095

LRZ 2 Grease

LRZ 2 longlife greases are new greases for roller and friction bearings, that are made from high quality basic oils by using lithium soaps as thickening agents. It shows an extraordinary oxidation resistance. LZR 2 greases are water resistant, adhesive, can be loaded with pressure and is protective against corrosion. These properties, in connection with high work resistance, very good abrasion rating and particularly strong adhesiveness, characterise this lubricant as particularly appropriate for lubrication under difficult operating conditions and at highly loaded roller and friction bearings. Practical advantages: LZR 2 can be used universally as long-term greases. They are recommended for lubrication of vehicles, industrial machinery and for all machines and devices in the field of construction, stone and earth. Temperature range: -30° to +120°C

400g cartridge for use with universal grease guns
 Part no.7682

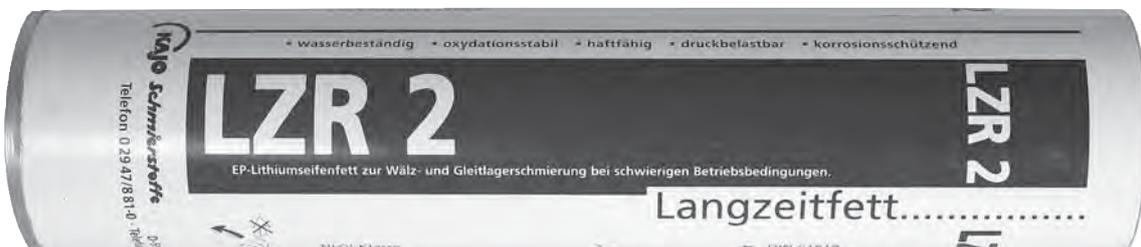

12.1

Cars fitted with Lockheed system

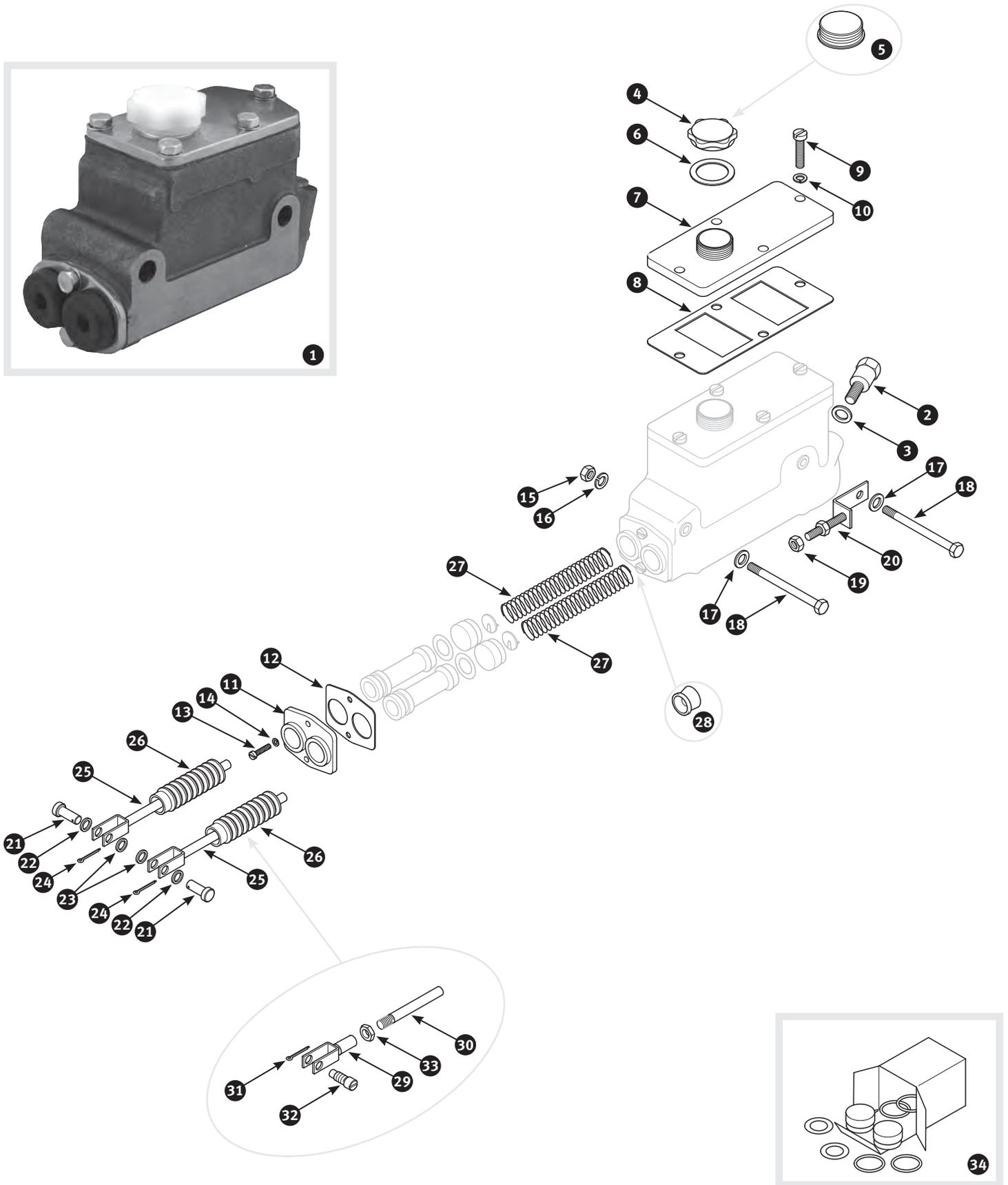

No	Part No	Description	Qty	Notes
1	299758	Brake and clutch master cylinder original type	1	
1	11268	Brake and clutch master cylinder replacement	1	
2	8749	Adaptor brake pipe	1	Use on replacement master cylinder
3	12064	Copper washer on adaptor	1	
4	8536	Filler cap - metal	1	Alternatives
5	4992	Filler cap - plastic	1	
6	21765	Gasket for metal filler cap	1	
7	300710	Cover	1	Use on original master cylinder
8	21422	Gasket	1	
9	5645	Screw	4	
10	209089	Shakeproof washer	4	
11	300711	Plate - front	1	
12	5644	Gasket	1	
13	5645	Screw	2	
14	209089	Shakeproof washer	2	
15	3073	Nut	2	
16	2051	Spring washer	2	
17	212195	Plain washer	4	
18	26515	Bolt	2	
19	7656	Nut	4	
20	300642	Locator bracket master cylinder	1	
21	14064	Clevis pin fork to pedal	2	
22	6307	Double coil washer	2	
23	212193	Plain washer	2	
24	10846	Split pin	2	
25	295688	Push rod original type	2	May replace original push rod 295688 (ill. 25)
26	13071	Gaiter push rod	2	
27	6311	Spring	2	
28	9288	Foot valve fitted on brake side only	1	
29	3348	Fork push rod	2	
30	13742	Push rod replacement	2	
31	3269	Split pin	2	
32	3349	Tapper screw	2	
33	7739	Nut push rod.	2	
34	3540	Seal kit clutch and brake master cylinder.	1	



AP Lockheed Brake fluid
 DOT4 - 1 litre
 Part no. 319587

12.2

Brake hydraulics

Brake hydraulics - TR3 from TS13046, TR3A, TR3B, TR4 and TR4A

Cars fitted with Girling system

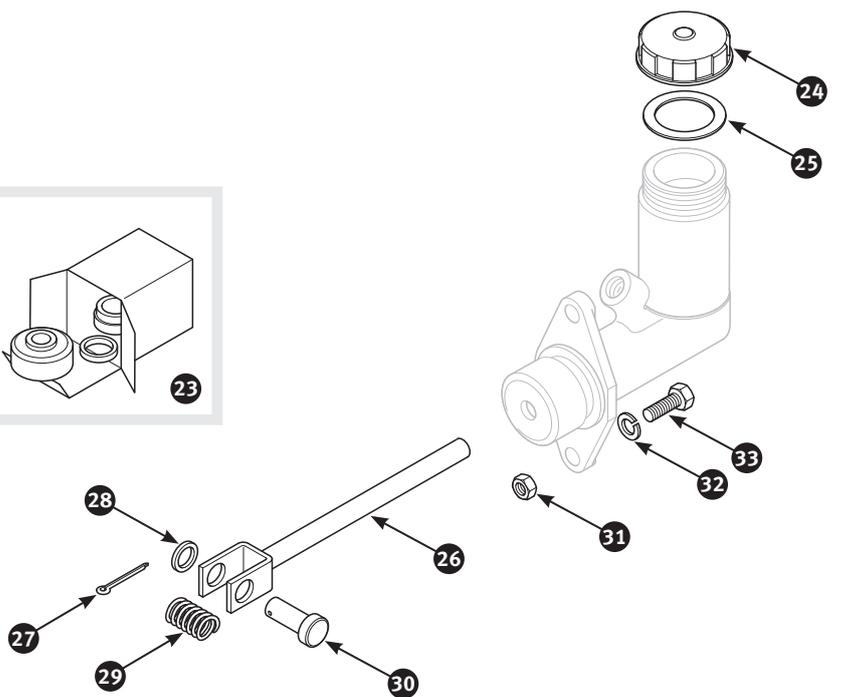
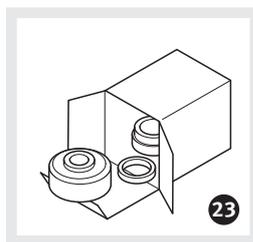
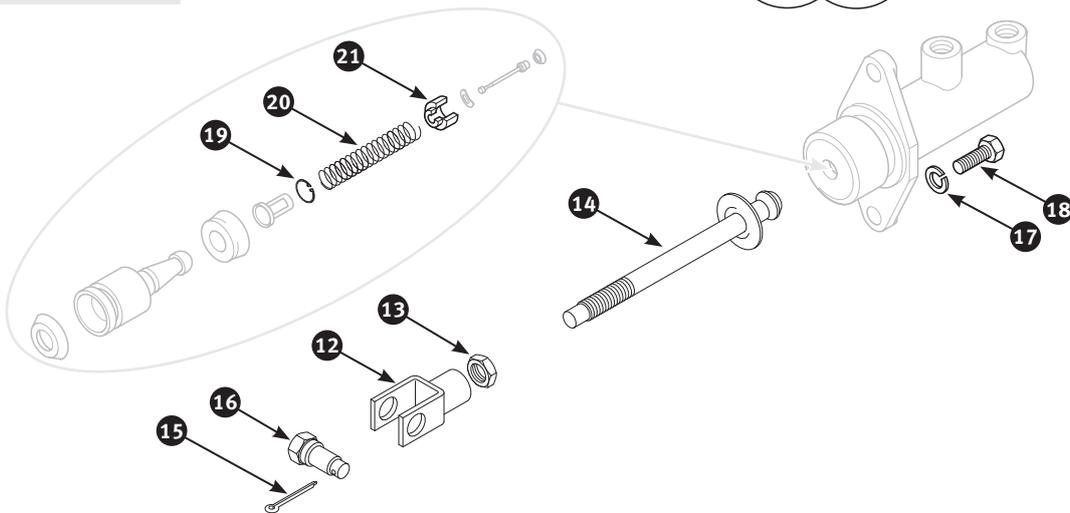
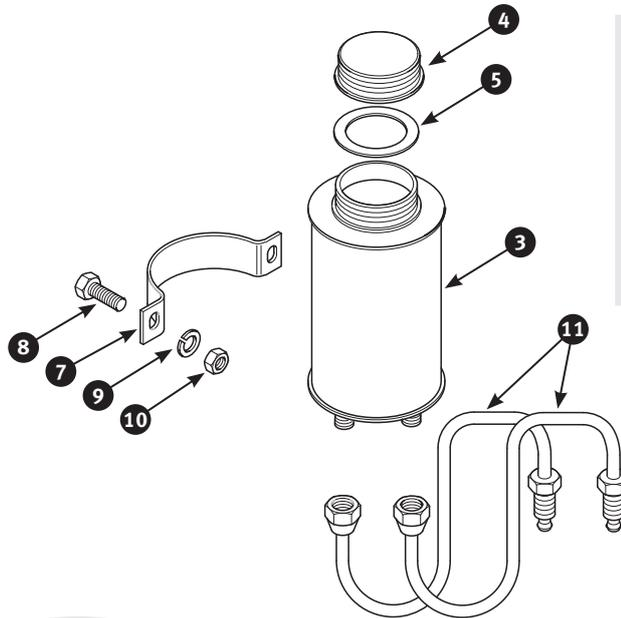
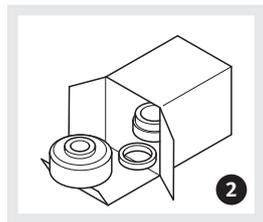

No	Part No	Description	Qty	Notes	
1	1455	Brake and clutch master cylinder less pushrod	1		
2	14463	Seal kit brake master cylinder.	1		
3	3516	Supply tank dual supply.	1		
4	17931	Filler cap supply tank.	1		
5	21320	Sealing ring filler cap.	1		
6	14561	Sticker ,Girling' - for supply tank.	1		
7	300657	Fixing strap supply tank.	1		
8	1912	Screw	2		
9	212192	Spring washer	2		
10	2828	Nut	2		
11	11637	Pipe supply tank to master cylinder	2		TR3 and TR3A
12	3348	Fork push rod	1		
13	7739	Nut	1		
14	15333	Push rod brake master cylinder.	1		
15	3269	Split pin	1		
16	3349	Tapper screw fork to brake pedal	1		
17	212194	Spring washer	2		
18	7894	Screw brake master cylinder retaining	2		
19	302306	Circlip push rod.	1		
20	304596	Return spring plunger	1		
21	21357	Spacer plunger spring	1		
22	15560	Brake master cylinder	1	TR4 to CT5783. Please note: the bore size of 0.75" is cast onto the outside of the cylinder	
23	14463	Seal kit brake master cylinder.	1		
22	1454	Brake master cylinder	1	TR4 from CT5784 and TR4A. Please note: the bore size of 0.70" is cast onto the outside of the cylinder	
23	14796	Seal kit brake master cylinder.	1		
24	5553	Filler cap brake master cylinder.	1	TR4 and TR4A	
25	17967	Sealing ring	1		
26	300723	Push rod brake master cylinder.	1		
27	7465	Split pin	1		
28	212193	Plain washer	1		
29	294502	Spring	1		
30	14064	Clevis pin fork to brake pedal.	1		
31	2303	Nut	1		
32	212194	Spring washer	2		
33	2826	Screw brake master cylinder retaining	2		



Brake servo
with fitting kit. Brake pressure: 1.90:1,
bore size: 5/8"
Part no. 281649

12.3

Brake hydraulics

Brake pedal and pedal box

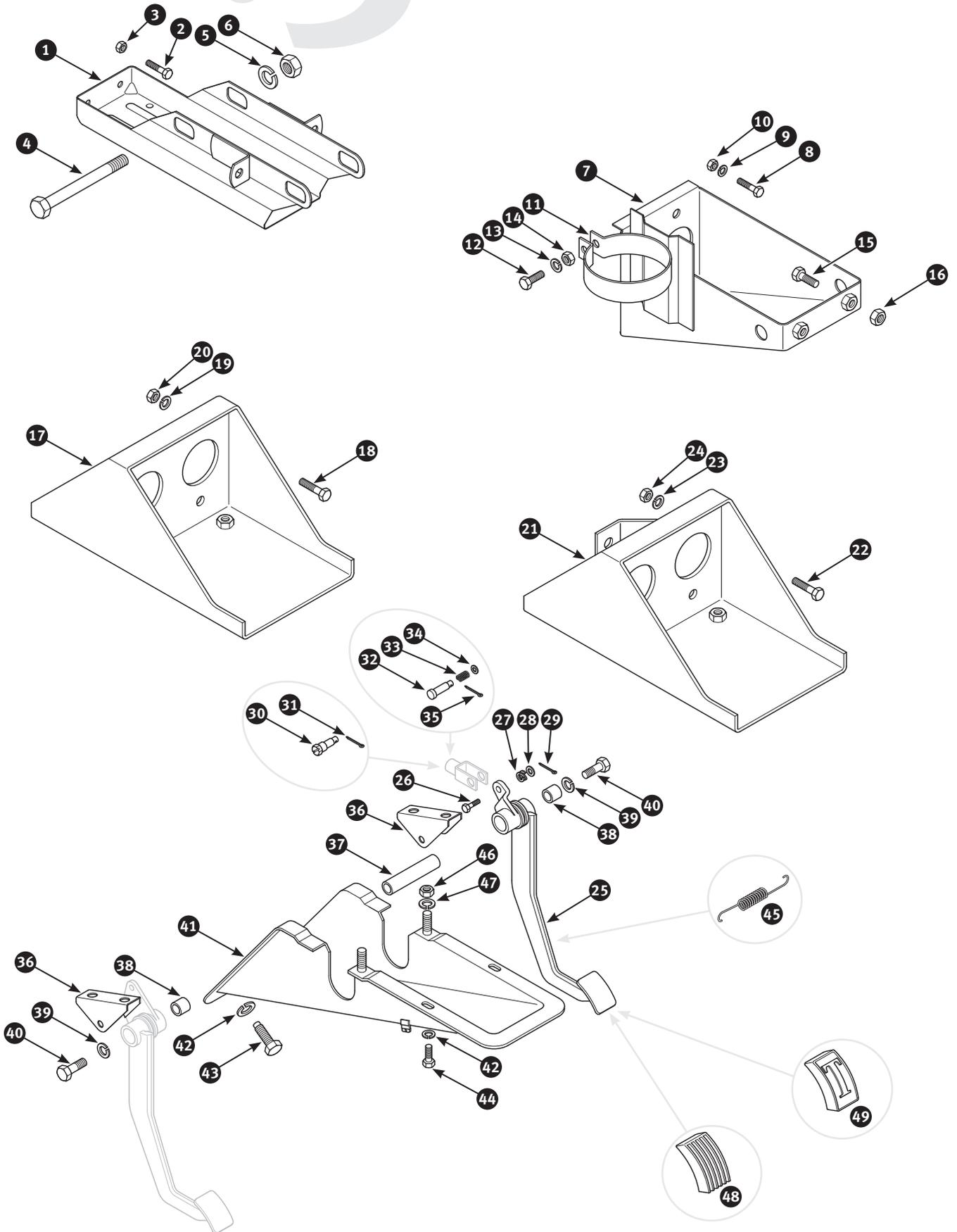

No	Part No	Description	Qty	Notes
1	468204	Bracket clutch and brake master cylinder	1	TR2, TR3 to TS13045. Cars fitted with Lockheed brake hydraulics
2	7886	Screw pedal stop	2	
3	7656	Nut	2	
4	26515	Bolt master cylinder to bracket	2	
5	212194	Spring washer	2	
6	2303	Nut	2	
7	300697	Bracket clutch and brake master cylinder	1	TR3 from TS13046 to TR3A. Cars fitted with Girling brake hydraulics
8	7894	Screw brake master cylinder to bracket	2	
9	212194	Spring washer	2	
10	2303	Nut	2	
11	300657	Fixing strap supply tank	1	
12	1912	Screw supply tank to bracket	1	
13	212192	Spring washer	1	TR4 to CT26929. Identify by hydraulic brake light switch
14	2828	Nut	1	
15	7886	Screw pedal stop	2	
16	7656	Nut	2	
17	324643	Bracket clutch and brake master cylinder	1	
18	7894	Screw brake master cylinder to bracket	2	
19	212194	Spring washer	2	TR4 from CT26930, TR4A. Identify by mechanical brake light switch
20	2303	Nut	2	
21	300686	Bracket clutch and brake master cylinder	1	
22	7894	Screw brake master cylinder to bracket	2	
23	212192	Spring washer	2	TR2, TR3 to TS13045. Cars fitted with Lockheed brake hydraulics
24	2303	Nut	2	
25	300640	Brake pedal LHD	1	
25	300636	Brake pedal RHD	1	
25	298167	Brake pedal LHD	1	TR3 from TS13046 to TR3A. Cars fitted with Girling brake hydraulics
25	300656	Brake pedal RHD	1	
25	468723	Brake pedal LHD	1	TR4 and TR4A
25	300676	Brake pedal RHD	1	
26	14064	Clevis pin fork to brake pedal	1	TR2, TR3 to TS13045. Cars fitted with Lockheed brake hydraulics
27	6307	Double coil washer	1	
28	212193	Plain washer	1	
29	10846	Split pin	1	
30	3349	Tapper screw fork to brake pedal	1	TR3 from TS13046 to TR3A. Cars fitted with Girling brake hydraulics
31	3269	Split pin	1	
32	14064	Clevis pin fork to brake pedal	1	TR4 and TR4A
33	294502	Spring	1	
34	212193	Plain washer	1	
35	7465	Split pin	1	
36	300637	Bracket pedal shaft	4	
37	2361	Pedal shaft	1	
38	9677	Bush pedal shaft	4	
39	2051	Spring washer	2	
40	7898	Screw	2	
41	300634	Cover pedal shaft	1	
42	212194	Spring washer	4	
43	212162	Screw cover to bulkhead	2	
44	7893	Screw cover to bulkhead	2	
45	3401	Return spring brake pedal	1	
46	2303	Nut	4	
47	212194	Spring washer	4	TR2, TR3 to TS13045 TR3 from TS13046 to TR3A to TR4A
48	226	Pedal rubber ribbed	1	
49	201064	Pedal rubber with ,T' logo	1	

12.4

Brake hydraulics Front brakes - TR2, TR3 to TS13045

Cars fitted with Lockheed system

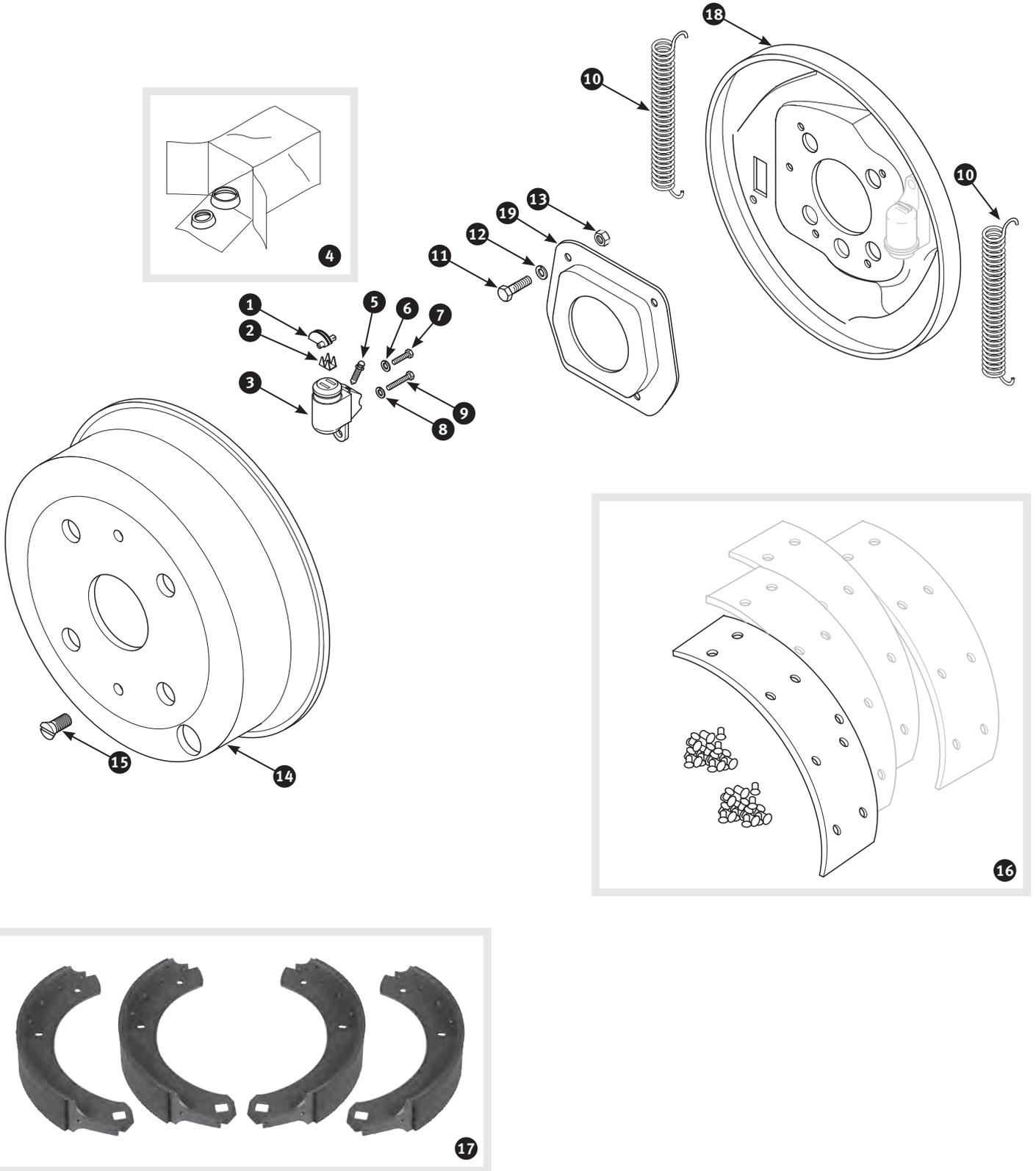

No	Part No	Description	Qty	Notes
1	9293	Brake adjuster	4	
2	9292	Bracket brake adjuster	4	
3	1064	Wheel cylinder RH	2	
3	1869	Wheel cylinder LH	2	
4	9336	Seal kit wheel cylinder	1	
5	202323	Bleed screw wheel cylinder	4	
6	212192	Spring washer	4	Wheel cylinder retaining
7	212149	Screw - length: 3/8"	4	
8	212194	Spring washer	4	
9	212162	Screw - length: 5/8"	4	
10	9295	Return spring brake shoes	4	Front hub link plate retaining
11	13660	Panhead screw	8	
12	212190	Spring washer	8	
13	215477	Nut	8	
14	26568	Brake drum	2	
15	2150	Countersunk screw brake drum	4	
16	16017	Brake shoe to reline	4	
17	10824	Brake shoes exchange	1	
18	328687	Brake anchor plate RH - used item	1	
18	328688	Brake anchor plate LH - used item	1	
19	320665	Link plate front hub	2	



Installation paste
for brake hydraulics
Part no. 17133

Order free of charge:

Tools catalogue

Order free of charge:

Tuning catalogue

Order free of charge:

Oils and lubricants catalogue

Order free of charge:

Accessories catalogue

Cars fitted with Girling system

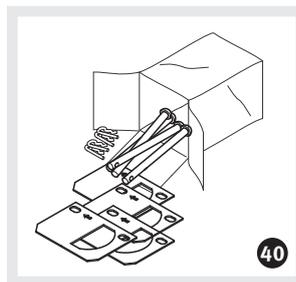
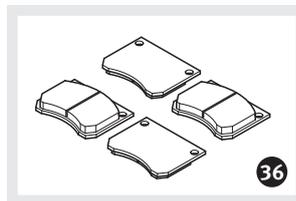
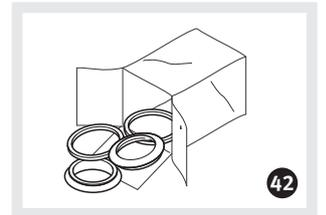
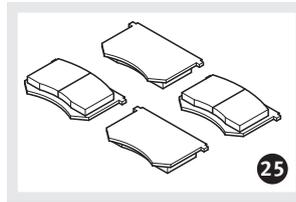
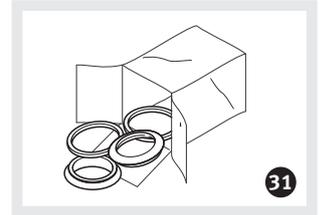
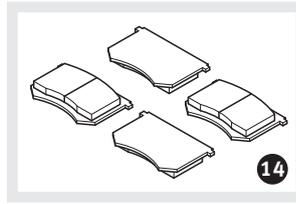
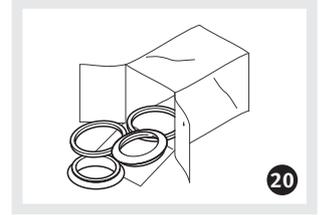
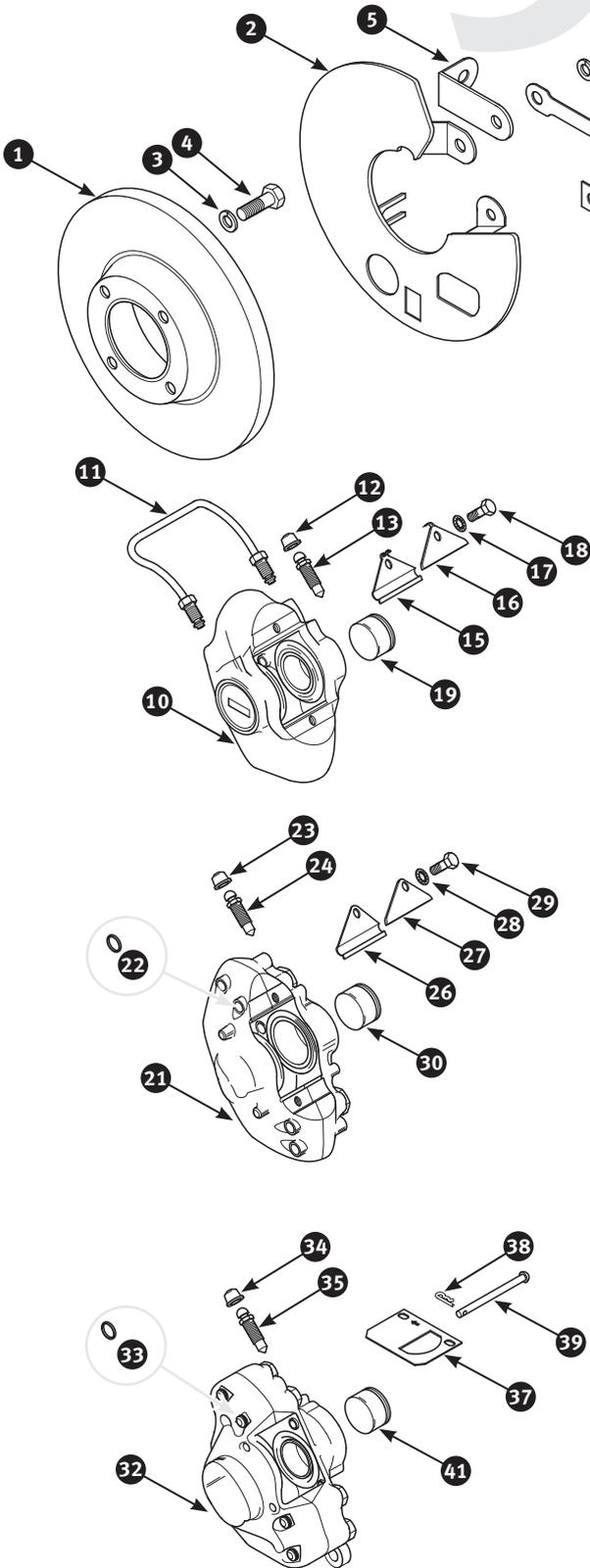

No	Part No	Description	Qty	Notes
1	1235	Brake disc - identify by 11" diameter	2	TR3, TR3A and TR3B TSF series, TR4 with wire wheels to CT4689, TR4 with disc wheels to CT4387
2	299771	Dust cover LH brake disc	1	
2	304371	Dust cover RH brake disc	1	TR3B TCF series, TR4 with wire wheels from CT4690, TR4 with disc wheels from CT4388
1	201084	Brake disc - identify by 10.13/16" diameter.	2	
2	338867	Dust cover LH brake disc	1	TR4A
2	304372	Dust cover RH brake disc	1	
1	201084	Brake disc - identify by 10.13/16" diameter.	2	Quantity as required
2	346	Dust cover LH brake disc	1	
2	345	Dust cover RH brake disc	1	
3	2051	Spring washer	8	
4	9583	Bolt brake disc to fron hub	8	
5	9594	Bracket brake hose	2	
6	2215	Spring washer	4	
7	10676	Bolt brake caliper retaining	4	
8	1813	Shim	0	
9	4962	Lock tab brake caliper	2	
10	203810	Brake caliper LH - exchange	1	
10	203809	Brake caliper RH - exchange	1	
11	2851	Brake pipe bridge between brake calipers	2	
12	11002	Dust cap bleed screw.	2	
13	205131	Bleed screw brake caliper.	2	
14	2758	Brake pads	1	TR3, TR3A with wire wheels to TS56376, TR3A with disc wheels to TS56383
15	19228	Retainer plate brake pads	4	
16	20300	Anti rattle plate brake pads retaining	4	
17	212192	Spring washer	4	
18	7884	Screw	4	
19	202456	Piston brake caliper.	4	
19	20517	Piston brake caliper - stainless steel	4	
20	3539	Seal kit brake caliper - for one caliper	2	
21	203814	Brake caliper LH - exchange	1	
21	203813	Brake caliper RH - exchange	1	
22	8564	,O' ring brake caliper bridge.	2	
23	11002	Dust cap bleed screw.	2	
24	205131	Bleed screw brake caliper.	2	TR3A with wire wheels from TS56377, TR3A with disc wheels from TS56384, TR3B TSF series, TR4 with wire wheels to CT4689, TR4 with disc wheels to CT4387
25	2758	Brake pads	1	
26	19231	Retainer plate brake pads	4	
27	19230	Anti rattle plate brake pads retaining	4	
28	212192	Spring washer	4	
29	7884	Screw	4	
30	202456	Piston brake caliper.	4	
30	20517	Piston brake caliper - stainless steel	4	
31	3539	Seal kit brake caliper - for one caliper	2	
32	12912	Brake caliper LH - exchange	1	
32	12913	Brake caliper RH - exchange	1	
33	8564	,O' ring brake caliper bridge.	2	
34	11002	Dust cap bleed screw.	2	
35	202323	Bleed screw brake caliper.	2	
36	7391	Brake pads	1	TR3B TCF series, TR4 with wire wheels from CT4690, TR4 with disc wheels from CT4388, all TR4A
37	1306	Anti squeal shims - supplied in sets of 4.	1	
38	3304	Retaining clip brake pads.	4	
39	5028	Retaining pin brake pads	4	
40	2679	Fitting kit brake pads. Contents: 4 retaining pins, 4 retaining clips, 4 anti squeal shims . . .	1	
41	202456	Piston brake caliper.	4	
41	20517	Piston brake caliper - stainless steel	4	
42	3539	Seal kit brake caliper - for one caliper	2	
43	205117	Mintex Brake pads - ,M1144' specification	1	TR3B TCF series, TR4 with wire wheels from CT4690, TR4 with disc wheels from CT4388, all TR4A. For further information see chapter 21.17
44	475036	Brake pads - Kevlar ,green stuff' specification	1	

12.6

Brake hydraulics

Rear brakes - TR2, TR3 to TS13045

Cars fitted with Lockheed system

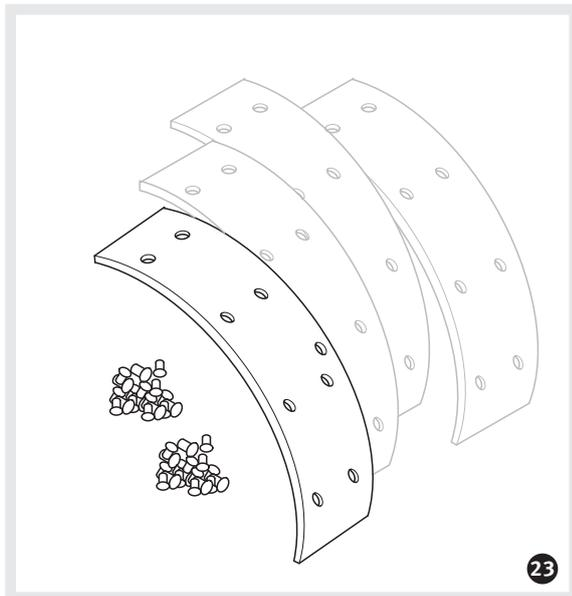
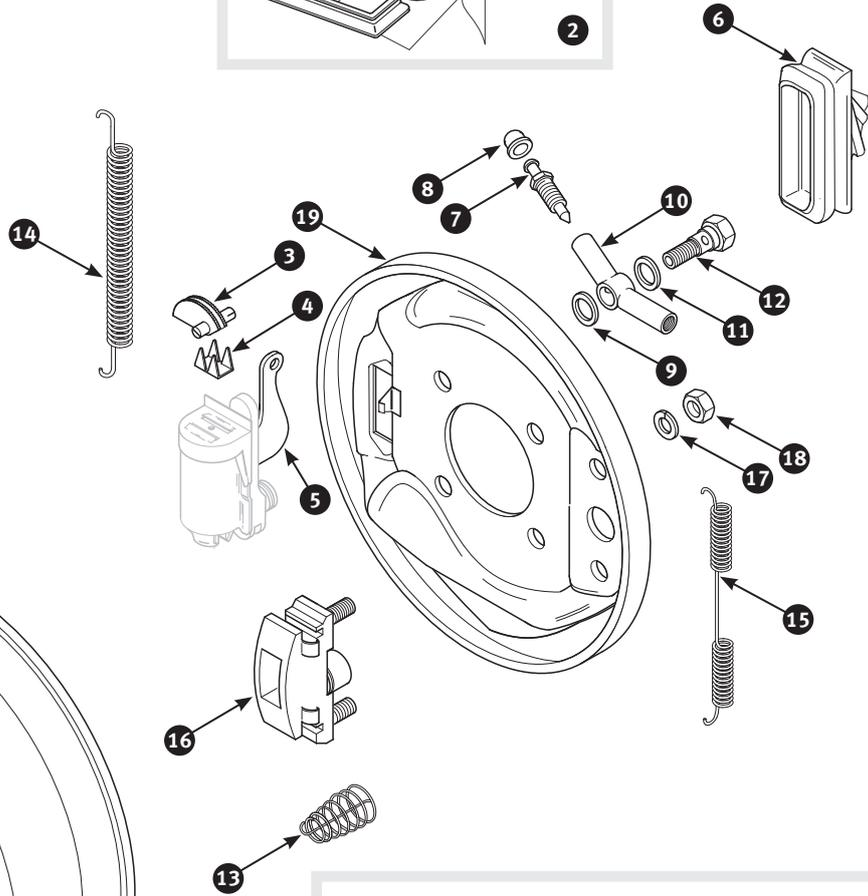
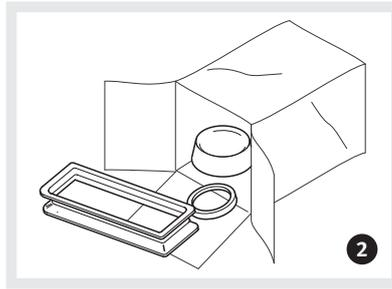

No	Part No	Description	Qty	Notes
1	3544	Wheel cylinder	2	
2	4064	Seal kit wheel cylinder	2	
3	9293	Brake adjuster	2	
4	9292	Bracket brake adjuster	2	
5	21359	Lever hand brake cable	2	
6	9299	Dust seal wheel cylinder	2	
7	2333	Bleed screw wheel cylinder	2	
8	11002	Dust cap bleed screw	2	
9	12064	Copper washer - small	2	
10	20939	Banjo union brake hose to wheel cylinder	2	
11	5465	Copper washer - large	2	
12	5328	Banjo bolt	2	
13	5643	Spring brake shoe retaining	4	TR2 from TS5443, TR3
14	9295	Return spring brake shoes - wheel cylinder end	2	
15	8558	Return spring brake shoes - mounting bracket end	2	
16	9294	Mounting bracket brake shoes	2	
17	212194	Spring washer	4	
18	19716	Nut mounting bracket retaining	4	
19	423399	Brake anchor plate LH rear - new item	1	TR2 to TS5442
19	302271	Brake anchor plate RH rear - new item	1	
19	328689	Brake anchor plate LH rear - used item	1	
19	304375	Brake anchor plate RH rear - used item	1	
19	368466	Brake anchor plate LH rear	1	TR2 from TS5443, TR3
19	368487	Brake anchor plate RH rear	1	
20	334	Brake drum - identify by 9" diameter	2	TR2 to TS5442
20	26568	Brake drum - identify by 10" diameter	2	TR2 from TS5443, TR3
21	2150	Countersunk screw brake drum	4	
22	15685	Brake shoes exchange	1	TR2 to TS5442 (identify by 9" brake drum)
22	10824	Brake shoes exchange	1	TR2 from TS5443, TR3 (identify by 10" brake drum)
23	16017	Brake shoe to reline	4	



Pin punches
 6 pc set. Contents: a 2, 3, 4, 5, 6 and 8 mm punch, 150 mm long each, 10 mm hexagon end, comes with a wooden display stand
 Part no. 246695

12.7

Brake hydraulics

Rear brakes - TR3 from TS13046, TR3A to TS56376

Cars fitted with Girling 10" system

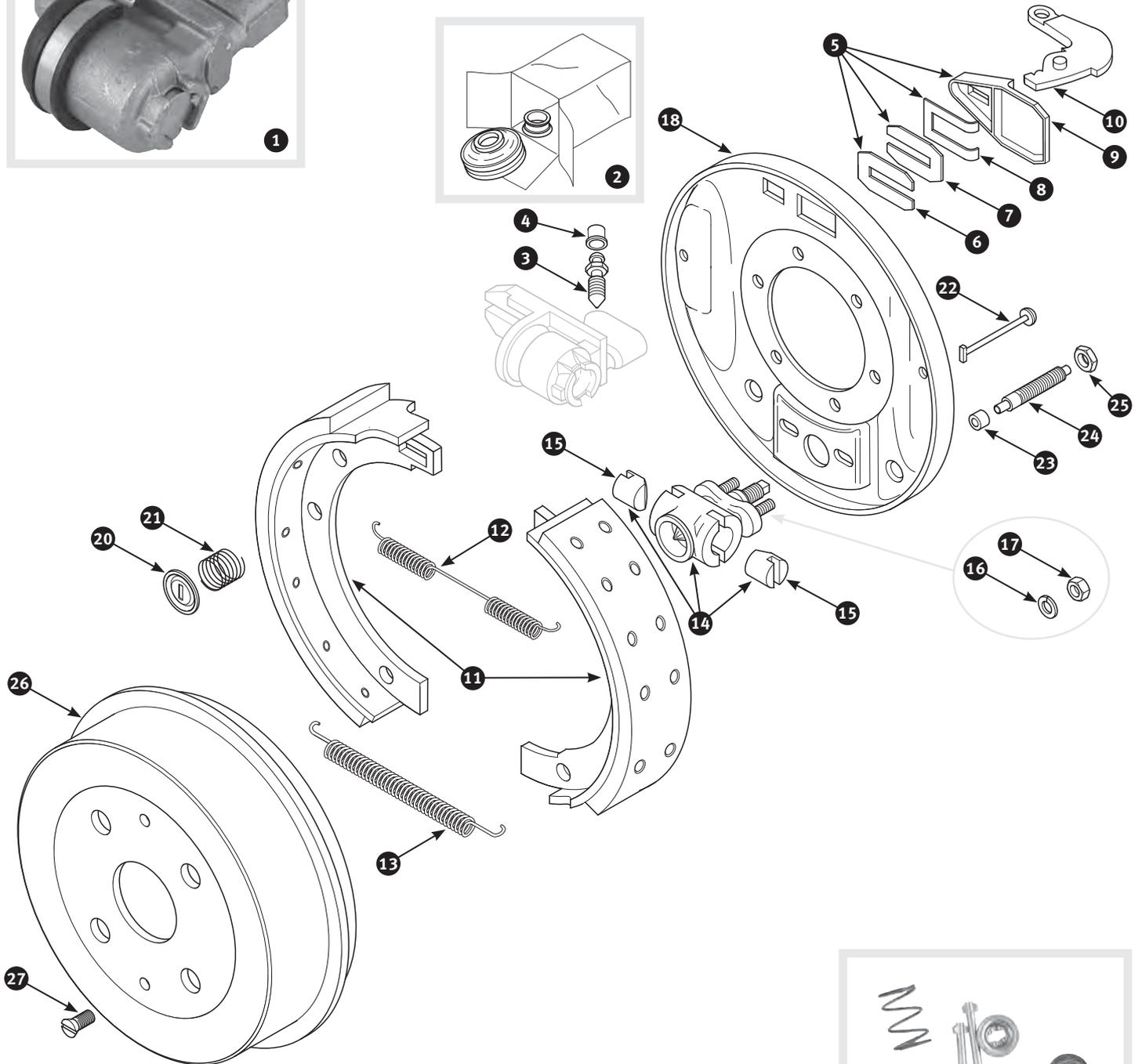

No	Part No	Description	Qty	Notes
1	15414	Wheel cylinder - identify by: 0.75" bore and flat piston	2	} TR3 to TS15331
1	7531	Wheel cylinder - identify by: 0.75" bore and slotted piston	2	
1	14013	Wheel cylinder - identify by: 0.625" bore (may replace genuine wheel cylinder)	2	} TR3A from TS34404
2	15405	Seal kit wheel cylinder with 0.75" bore - cylinder set	2	
2	1457	Seal kit wheel cylinder with 0.625" bore - axle set	1	} TR3, TR3A to TS34403
2	14718	Seal kit wheel cylinder with 0.7" bore - axle set	1	
3	202323	Bleed screw wheel cylinder	2	} TR3A from TS34404
4	11002	Dust cap bleed screw	2	
5	1307	Fitting kit wheel cylinder - axle set	1	
6	11360	Anti rattle plate - separately	2	
7	15031	Clamping plate - separately	2	
8	20510	Clamp - separately	2	
9	11361	Gaiter - separately	2	
10	205148	Lever hand brake cable	2	
11	2456	Brake shoe exchange	4	
12	1222	Return spring brake shoes	2	
13	16567	Return spring brake shoes	2	
14	16490	Brake adjuster	2	
15	326972	Wedge brake adjuster	2	
16	3542	Shakeproof washer	4	
17	2303	Nut brake adjuster to anchor plate	4	
18	321034	Brake anchor plate LH - new item	1	
18	326428	Brake anchor plate LH - used item	1	
18	319908	Brake anchor plate RH - new item	1	
18	326429	Brake anchor plate RH - used item	1	
19	20290	Fitting kit brake shoes	1	
20	4960	Washer - separately	4	
21	9870	Spring - separately	4	
22	8574	Steady pin - separately	4	
23	17836	Felt bush on steady post	4	
24	300243	Steady pin brake shoes	4	
25	227871	Nut on steady post	4	
26	26568	Brake drum	2	
27	2150	Countersunk screw brake drum	4	

Screw kit

800 pieces. Screws, washers, nuts and spring washers 1/4, 5/16 and 3/8" UNF yellow galvanised, Part no. 486713
zink plated, Part no. 336814

400 pieces, UNC
zink plated, Part no. 480661

200 pieces, BSF
zink plated, Part no. 295797



12.8

Brake hydraulics

Rear brakes - TR3A from TS56377, TR3B, TR4 and TR4A

Cars fitted with Girling 9" system

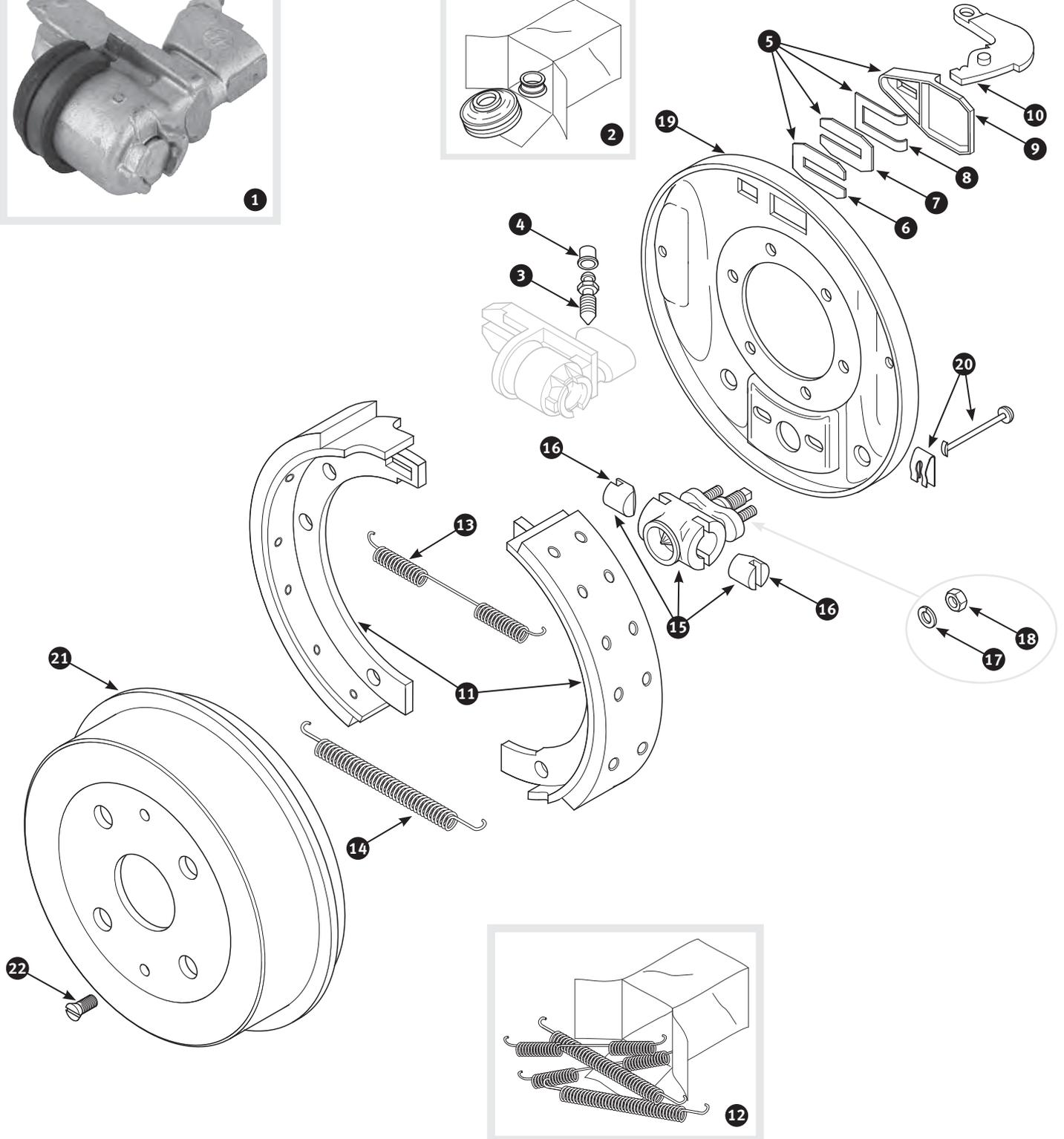

No	Part No	Description	Qty	Notes
1	15414	Wheel cylinder - identify by: 0.75" bore and flat piston	2	TR3B, TR4 with wire wheel to CT5655, TR4 with disc wheels to CT5782
2	15405	Seal kit wheel cylinder with 0.75" bore - cylinder set	2	
1	14013	Wheel cylinder - identify by: 0.70" bore	2	TR4 with wire wheels from CT5656, TR4 with disc wheels from CT5783, all TR4A
2	14718	Seal kit wheel cylinder with 0.7" bore - axle set	1	
3	202323	Bleed screw wheel cylinder	2	
4	11002	Dust cap bleed screw	2	
5	1307	Fitting kit wheel cylinder - axle set	1	
6	11360	Anti rattle plate - separately	2	
7	15031	Clamping plate - separately	2	
8	20510	Clamp - separately	2	
9	11361	Gaiter - separately	2	
10	205148	Lever hand brake cable	2	
11	15919	Brake shoes	1	
12	3070	Return springs brake shoes - supplied in sets of 4	1	
13	1222	Return spring brake shoes - separately	2	
14	1822	Return spring brake shoes - separately	2	
15	10234	Brake adjuster	2	
16	5094	Wedge brake adjuster	4	
17	209089	Shakeproof washer	4	
18	2828	Nut brake adjuster to anchor plate	4	
19	327629	Brake anchor plate LH	1	TR3A, TR3B and TR4
19	327630	Brake anchor plate RH	1	
19	10581	Brake anchor plate LH	1	TR4A
19	10582	Brake anchor plate RH	1	
20	2597	Fitting kit brake shoes	1	
21	334	Brake drum	2	
22	2150	Countersunk screw brake drum	4	



Wheel balancer

portable. Can be used for balancing alloy, steel or wire wheels with a centre hub from 1/2" to 4". Uses a spring loaded pressure plate and a bull's eye bubble level to indicate where the extra weight is needed. For professional or semi-professional use. Part no. 315726

12.9

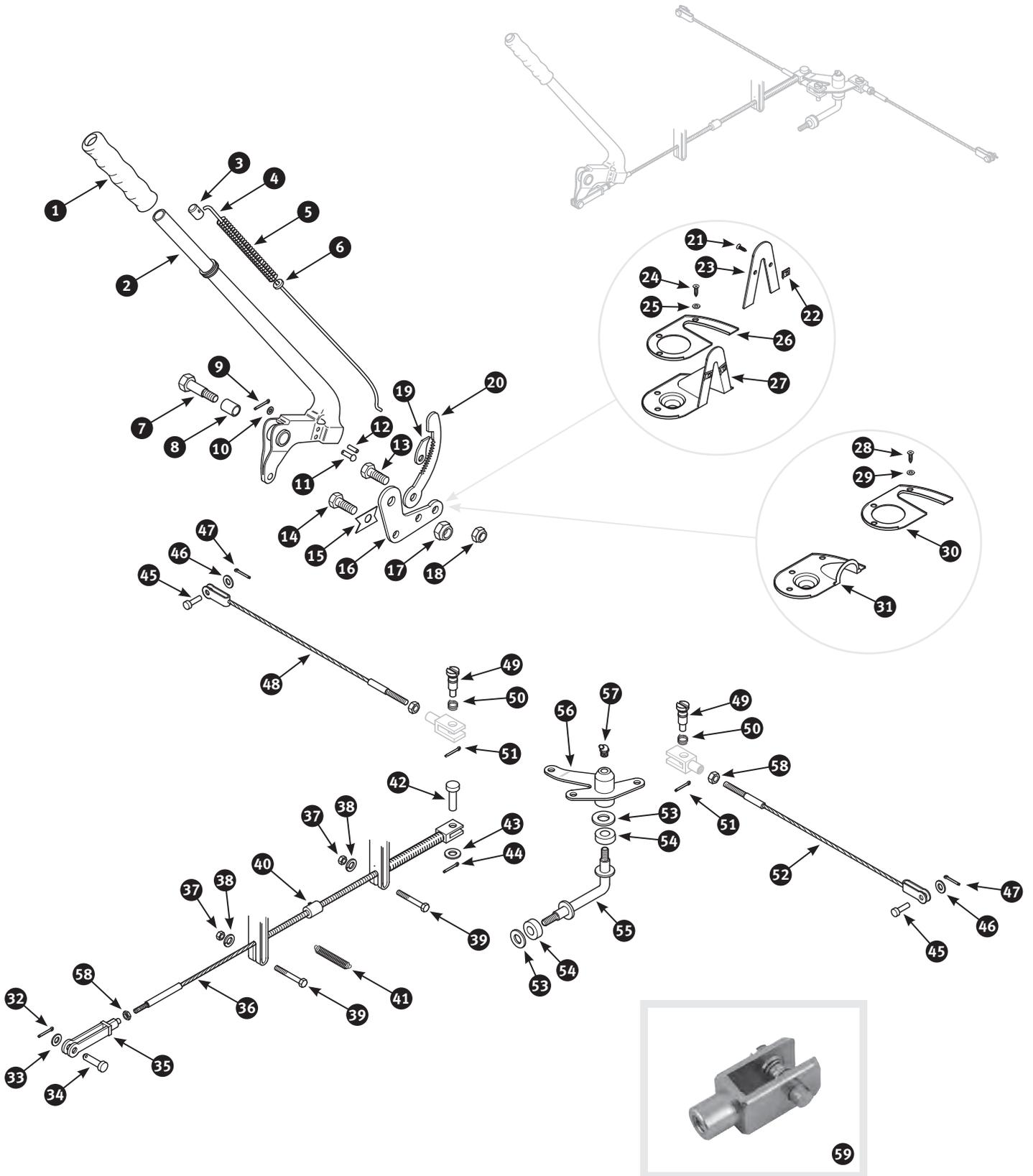

No	Part No	Description	Qty	Notes
1	14987	Handbrake grip - screw-on type	1	TR2 to TR3B
1	9563	Handbrake grip - push-on type	1	
1	9327	Handbrake grip - burr walnut replacement	1	TR4
2	287103	Handbrake lever	1	
2	287109	Handbrake lever	1	TR2 to TR3B
3	300641	Knob handbrake lever	1	
4	287176	Connecting rod knob to cawl	1	TR4
5	222	Spring	1	
6	212193	Plain washer	1	
7	21387	Pivot bolt handbrake lever	1	
8	5640	Bush	1	
9	3805	Split pin	1	
10	7793	Plain washer	1	
11	1438	Clevis pin handbrake lever pawl	1	
12	298799	Pin pawl release	1	
13	7893	Screw ratchet to locating plate	1	
14	212162	Screw locating plate to chassis	1	
15	20841	Lock tab	1	
16	287177	Locating plate handbrake lever	1	
17	212113	Nyloc nut pivot bolt	1	
18	2049	Nyloc nut	1	
19	11253	Pawl handbrake lever	1	
20	10830	Ratchet handbrake lever	1	
21	19535	Self tapping screw	2	TR2 to TR3B
22	3081	Spire nut	2	
23	200947	Retainer gaiter to gearbox tunnel	1	TR4
24	21135	Self tapping screw	3	
25	1717	Plain washer	3	
25	11270	Retainer gaiter to floor panel	1	TR2 to TR3B
27	2517	Gaiter handbrake lever	1	
28	21135	Self tapping screw	3	TR4
29	1717	Plain washer	3	
30	2223	Retainer gaiter to floor panel	1	
31	2526	Gaiter handbrake lever	1	
32	3805	Split pin	1	
33	212193	Plain washer	1	
34	14045	Clevis pin	1	
35	2341	Fork handbrake cable	1	
36	332	Handbrake cable front	1	
37	2828	Nut	2	
38	212192	Spring washer	2	
39	3938	Bolt	2	

No	Part No	Description	Qty	Notes
40	3346	Grease nipple handbrake cable	1	
41	3431	Spring handbrake cable to gearbox tunnel.	1	
42	20816	Clevis pin	1	
43	212191	Plain washer	1	
44	10846	Split pin	1	
45	9664	Clevis pin	2	
46	212193	Plain washer	2	
47	3269	Split pin	2	
48	243	Handbrake cable RH	1	Tr2 to TR3B
48	266	Handbrake cable RH	1	
49	300622	Clevis pin	2	
50	294880	Spring	2	
51	10846	Split pin	2	
52	2002	Handbrake cable LH.	1	TR2 to TS5442
52	244	Handbrake cable LH.	1	
52	265	Handbrake cable LH.	1	TR4
53	20988	Felt washer	2	
54	212196	Plain washer	2	
55	300627	Bar compensator bracket	1	
56	300628	Compensator bracket handbrake mechanism	1	
57	3345	Grease nipple compensator bracket.	1	
58	7656	Nut	1	
59	215139	Fork handbrake cable, with clevis pin assembly	2	

Eezibleed Brake bleeding set

An excellent way to take away the fuss and mess from bleeding hydraulic systems. Fed by air pressure from the spare wheel, it provides 1/4 Lb of pressure to the fluid container
 Part no. 21558



12.10

Brake hydraulics

Handbrake - TR4A

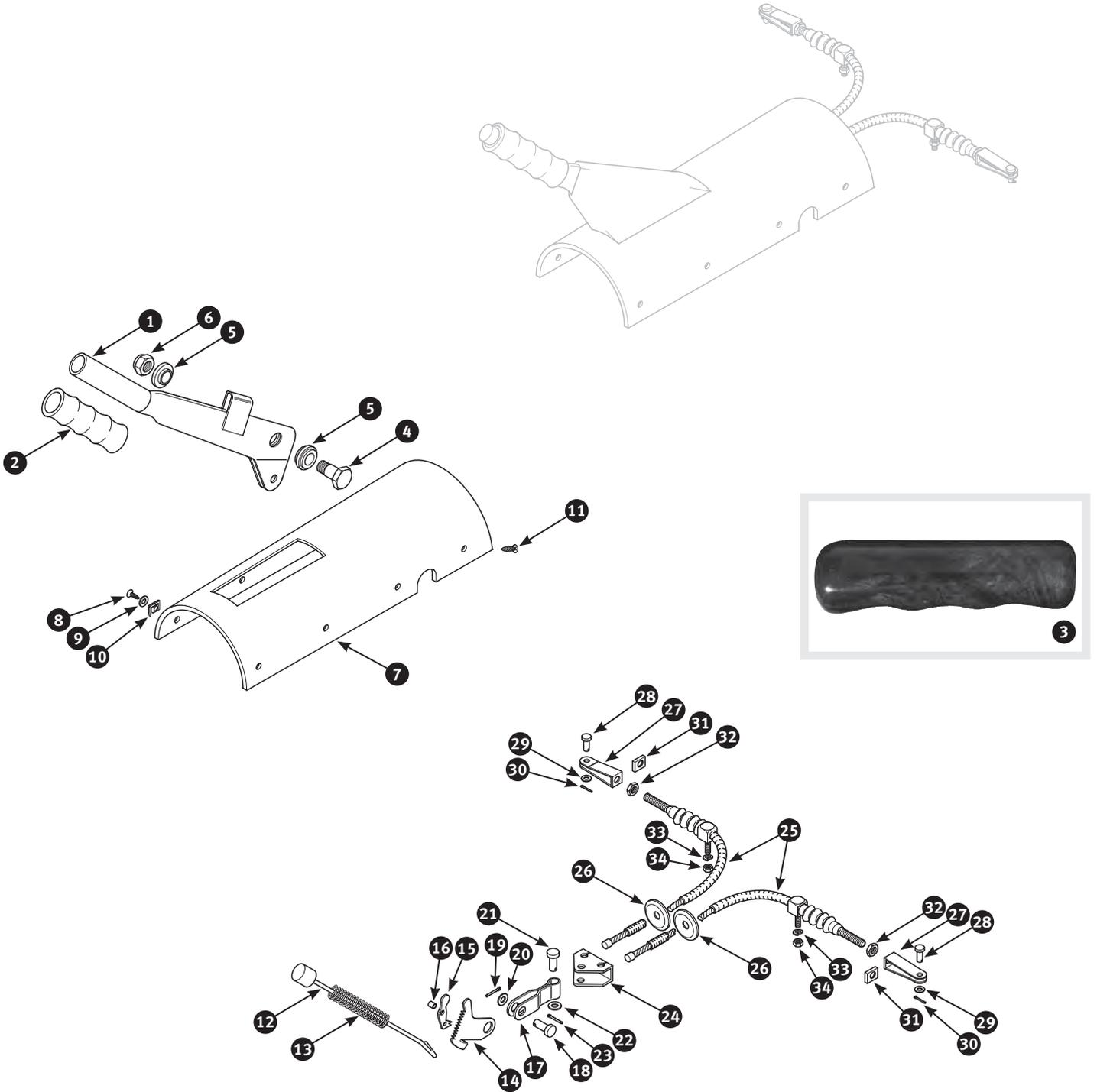

No	Part No	Description	Qty	Notes
1	227870	Handbrake lever	1	
2	9563	Handbrake grip - original style	1	} Alternatives For further information see chapter 21.24
3	9327	Handbrake grip - burr walnut replacement	1	
3	307115	Handbrake grip - elm replacement	1	
4	26341	Fulcrum pin handbrake lever	1	
5	201130	Eye bush handbrake lever	2	
6	2829	Nyloc nut	1	
7	1874	Cover handbrake cable - made from cardboard	1	} Alternatives
7	323993	Cover handbrake cable - made from GFK	1	
8	10741	Screw cover to gearbox tunnel	1	} Upper fixing
9	7793	Plain washer	1	
10	19416	Spire nut	1	
11	4163	Self tapping screw cover to gearbox tunnel	8	} Side fixing
12	293523	Operating rod pawl	1	
13	222	Spring	1	
14	18114	Ratchet handbrake lever	1	
15	220	Pawl handbrake lever - replacement	1	
16	221	Bolt pawl	1	
17	298766	Connector compensator bracket to handbrake lever	1	
18	16577	Clevis pin	1	
19	3805	Split pin	1	
20	12821	Plain washer	1	
21	7131	Clevis pin	1	
22	10740	Plain washer	1	
23	10846	Split pin	1	
24	300689	Compensator bracket handbrake cable	1	
25	9561	Handbrake cable	2	
26	22735	Grommet handbrake cable through heelboard	2	
27	1815	Fork handbrake cable	2	
28	9664	Clevis pin	2	
29	212193	Plain washer	2	
30	3269	Split pin	2	
31	10629	Square nut	2	
32	7656	Nut	2	
33	212192	Spring washer	2	
34	2828	Nut	2	



Hamper

for 2 persons, willow made with leather handle, size: 47 x 32 x 22 cm

Content: two white porcelain plates, two white porcelain cups in a willow bread basket, one 1-litre vacuum flask, 6-piece stainless steel cutlery, one opener and one rectangular shaped container

Part-no.: 331055

12.11

Brake hydraulics Brake pipes - TR2, TR3 to TS13045

Cars fitted with Lockheed system

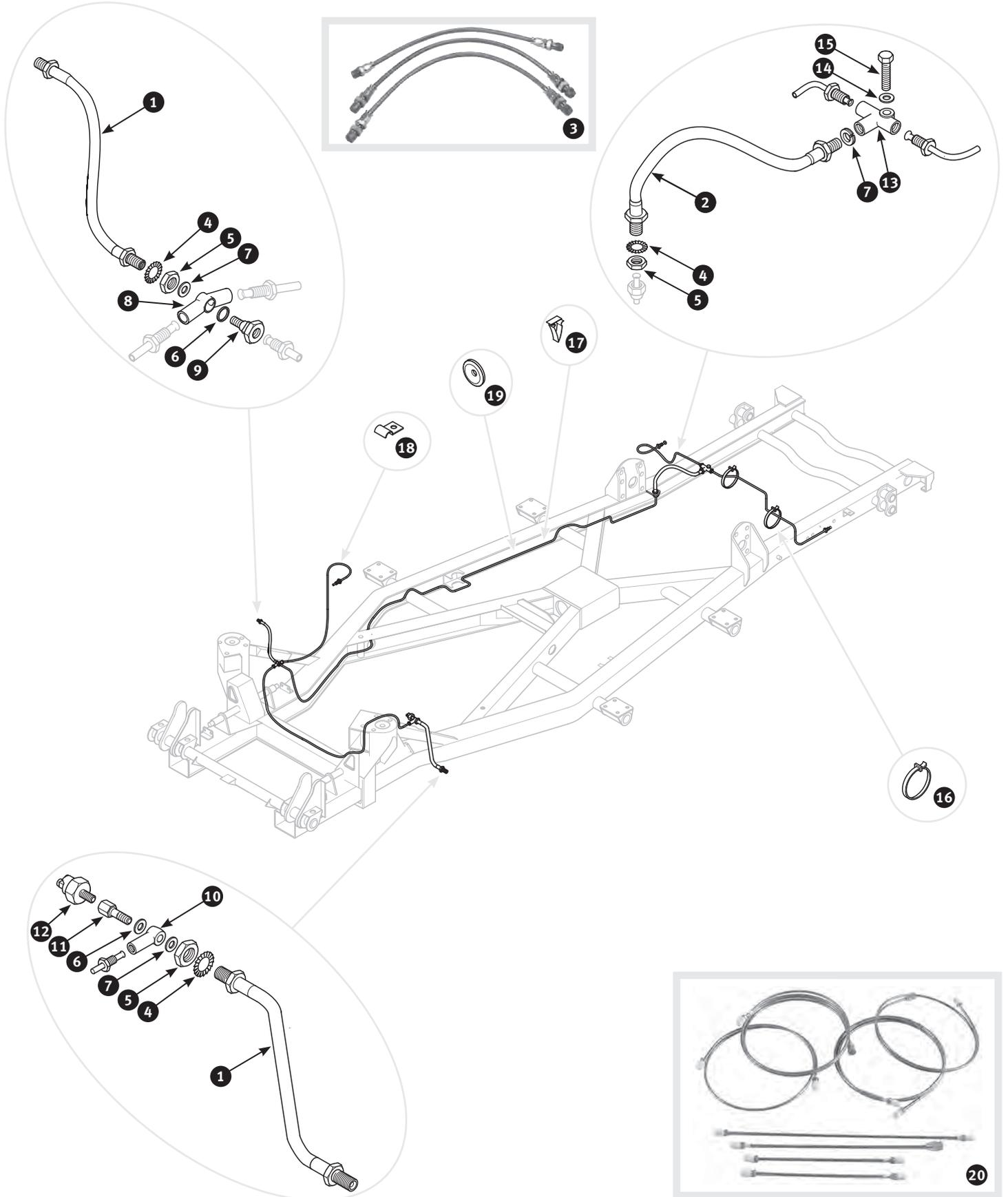

No	Part No	Description	Qty	Notes
1	11825	Brake hose front	2	
2	11826	Brake hose rear	2	
3	295770	Brake hoses aeroquip type, set with 3 lines	1	
4	300330	Shakeproof washer	3	
5	5356	Locking nut brake hose	3	
6	5465	Copper washer	2	
7	12064	Copper washer	3	
8	20939	Banjo union brake hose to wheel cylinder	1	
9	8936	Adaptor brake pipe to banjo union	1	
10	1748	Banjo union brake hose to wheel cylinder and to brake light switch	1	
11	298965	Adaptor brake pipe to banjo union	1	
12	204816	Brake light switch hydraulic, with screw-in terminals	1	} Alternatives
12	200834	Brake light switch hydraulic, with lucar terminals	1	
13	20990	3 way brake union rear	1	
14	212192	Spring washer	1	
15	7891	Screw brake union to chassis frame	1	
16	8495	Hose clip brake pipe to rear axle - metal	3	} Alternatives
16	19842	Cable strap brake pipe to rear axle - plastic	3	
17	3423	Retaining clip brake pipe to chassis	4	
18	3424	Retaining clip brake pipe to bulkhead	0	} Quantity as required
19	13655	Grommet brake pipe through chassis	2	
20	26076	Brake pipe set	1	} LHD
30	18035	Brake pipe set	1	} RHD

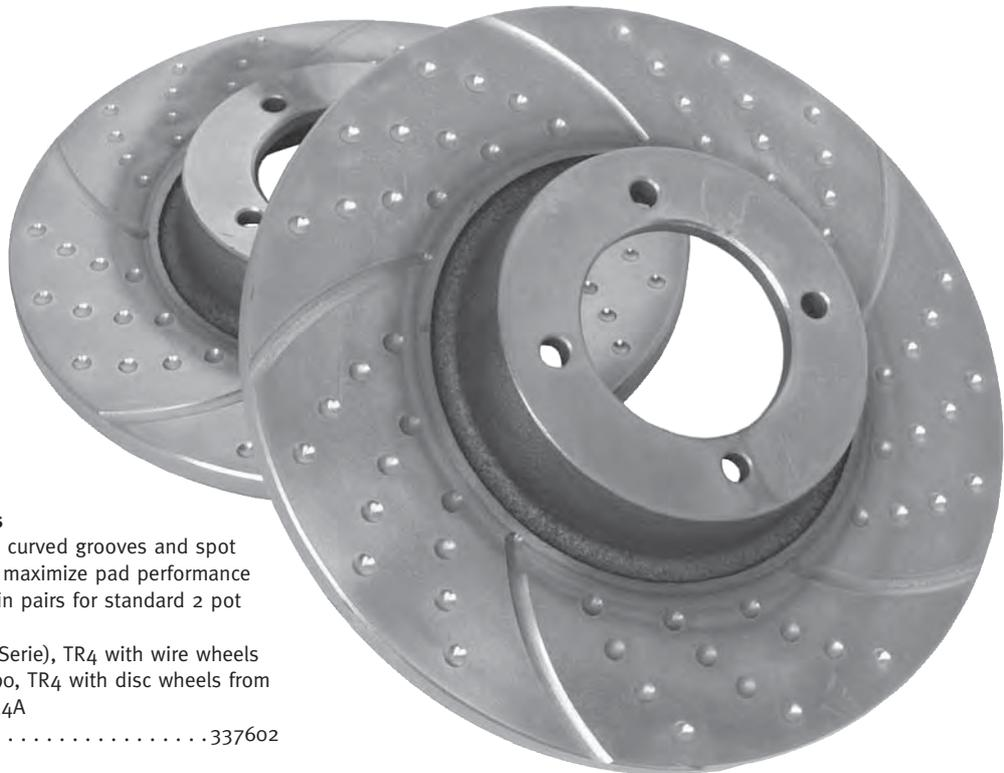

Brake discs
 front - with curved grooves and spot drillings to maximize pad performance
 - supplied in pairs for standard 2 pot calipers
 TR3B (TCF Serie), TR4 with wire wheels from CT4690, TR4 with disc wheels from CT4388, TR4A
 Part no. 337602

12.12

Brake hydraulics

Brake pipes - TR3 from TS13046, TR3A and TR4

Cars fitted with Girling system

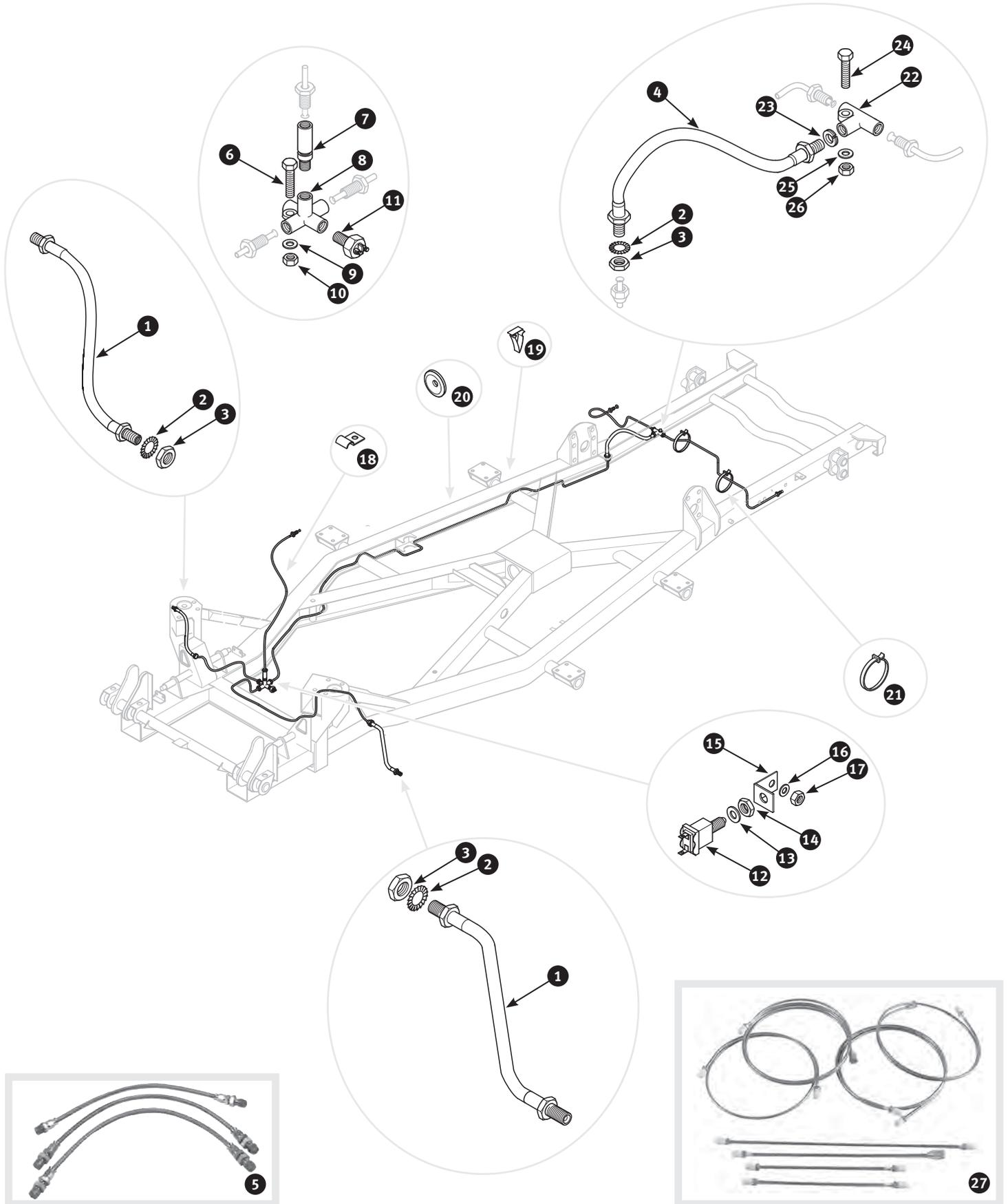

No	Part No	Description	Qty	Notes
1	955	Hydraulic hose front brakes	2	
2	209117	Shakeproof washer	3	
3	7741	Nut brake hose to bracket	3	
4	336493	Brake hose rear axle	1	
5	312461	Brake hoses aeroquip type, set with 3 lines.	1	
6	6514	Bolt brake union to chassis	1	
7	200431	Foot valve brake union	1	} Use only, when brake master cylinder has no check valve fitted
8	205123	Brake union 5 way.	1	} TR3, TR3A, TR3B, TR4 to CT26929
9	212191	Plain washer	1	
10	212451	Nyloc nut	1	
11	17711	Brake light switch hydraulic, with lucar terminals	1	} TR3, TR3A, TR3B, TR4 to CT26929
12	2395	Brake light switch mechanical.	1	} TR4 from CT26930 - fixed at pedal box
13	3813	Shakeproof washer	1	
14	3201	Nut	1	
15	9594	Bracket brake light switch	1	
16	3813	Shakeproof washer	1	} Quantity as required
17	3201	Nut	1	
18	3424	Retaining clip brake pipe to bulkhead	0	
19	3423	Retaining clip brake pipe to chassis	3	
20	13655	Grommet brake pipe through chassis.	2	
21	8495	Hose clip brake pipe to rear axle - metal	3	} Alternatives
21	19842	Cable strap brake pipe to rear axle - plastic.	3	
22	26077	Brake pipe set - LHD	1	} TR3, TR3A with wire wheel to TS56376, TR3A with disc wheel to TS56383
22	18036	Brake pipe set - RHD	1	
22	26118	Brake pipe set - LHD	1	} TR3A with wire wheels from TS56377, TR3A with disc wheels from TS56384, all TR3B and TR4
22	215077	Brake pipe set - RHD	1	

„A-Fin“ Brake drum

made of aluminium alloy with bonded iron inserts and circumferential fins. These brake drums improve heat dissipation, add to the braking capacity of your car and also reduces the fading.

Two needed per car.

TR3A from TS56377, TR3B, TR4 and TR4A (cars with 9" brakes)

Part no.3288



12.13

Brake hydraulics

Brake pipes - TR4A IRS

Cars fitted with Girling system and independent rear axle

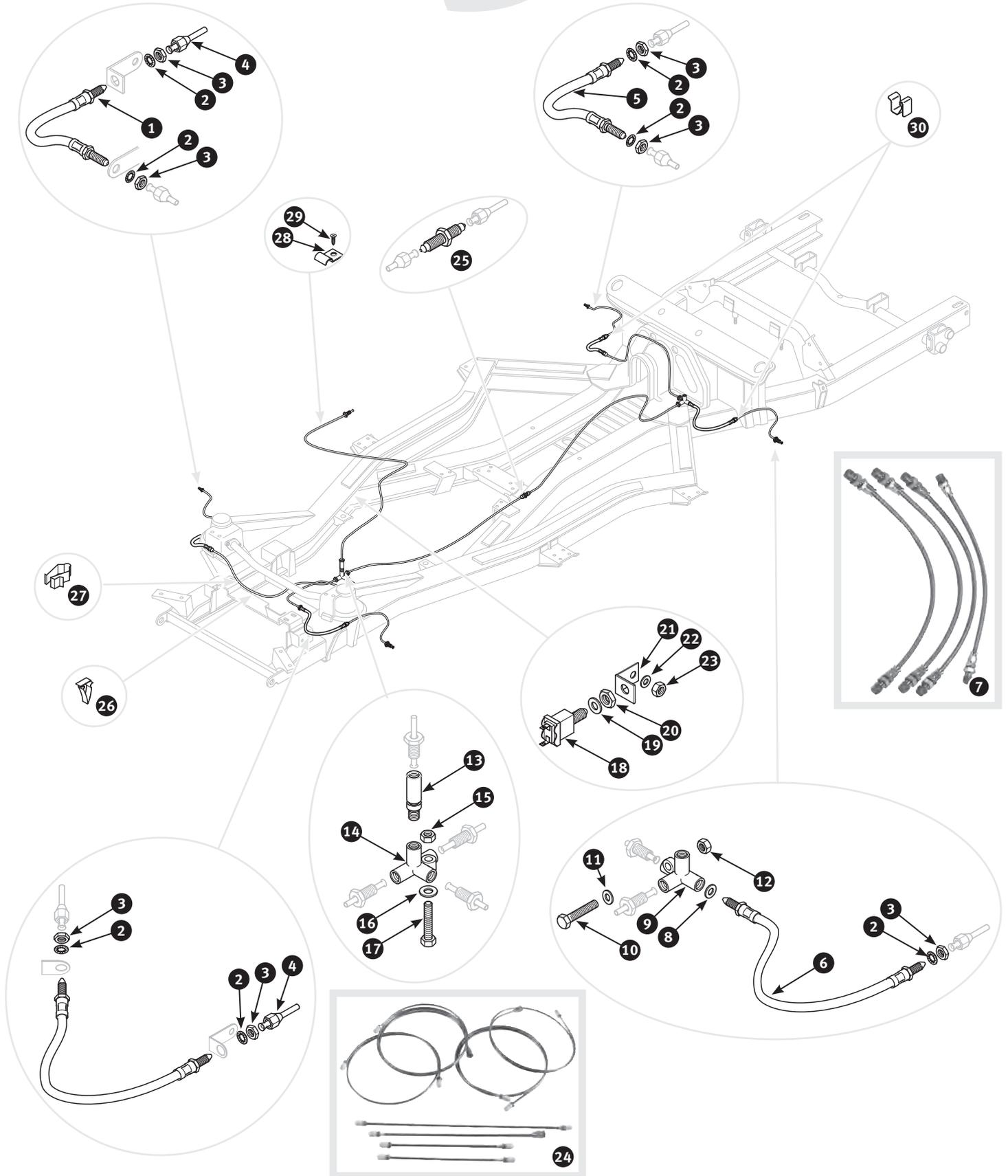

No	Part No	Description	Qty	Notes
1	11827	Brake hose front	2	
2	209117	Shakeproof washer	7	
3	7741	Nut brake hose to bracket	7	
4	10358	Brake pipe front - brake hose to caliper.	2	
5	11823	Brake hose LH rear	1	
6	11822	Brake hose RH rear	1	
7	343272	Brake hoses aeroquip type, set with 4 lines.	1	
8	12064	Copper washer	1	
9	202384	3 way brake union rear	1	
10	315904	Bolt	1	
11	212191	Plain washer	1	
12	212451	Nyloc nut	1	
13	200431	Foot valve brake union	1	} Use only, when brake master cylinder has no check valve fitted
14	11465	4 way brake union	1	
15	212451	Nyloc nut	1	
16	212191	Plain washer	1	
17	6514	Bolt brake union to chassis	1	
18	2395	Brake light switch mechanical.	1	} Fixed at pedal box
19	3813	Shakeproof washer	1	
20	3201	Nut	1	
21	9594	Bracket brake light switch	1	
22	3813	Shakeproof washer	1	
23	3201	Nut	1	
24	26119	Brake pipe set LHD	1	
24	12553	Brake pipe set RHD	1	
25	202318	Inline connector brake pipe	1	
26	3423	Retaining clip brake pipe to chassis	6	
27	293620	Clip brake pipe to RH chassis rail	1	
28	8694	Retaining clip brake pipe to bulkhead	1	
29	20031	Self tapping screw	1	
30	293468	Retaining clip brake pipe to trailing arm	2	

Flaring tool

for copper, brass and thin walled aluminium tubing, flares pipes from 3/16 to 5/8" diameter, makes male, female & double flares

Part no. 311132

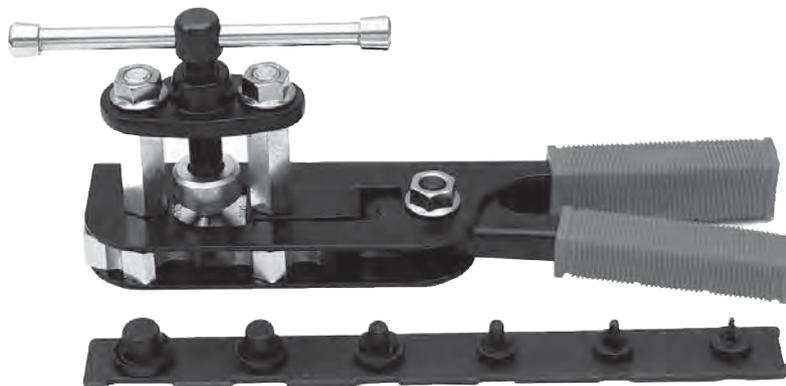

12.14

Brake hydraulics

Brake pipes - TR4A

Cars fitted with Girling system and solid rear axle

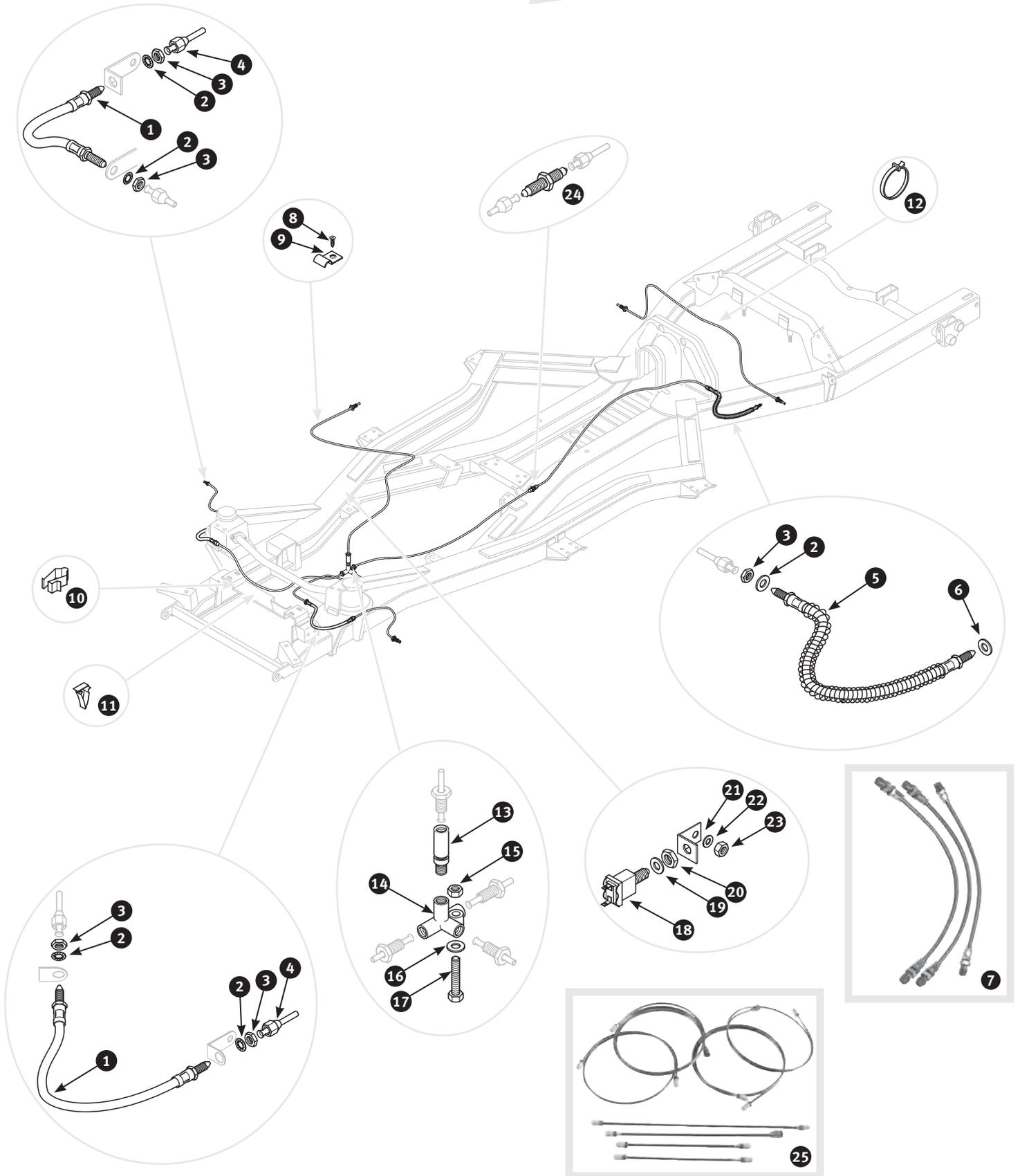

No	Part No	Description	Qty	Notes
1	11827	Brake hose front	2	
2	209117	Shakeproof washer	3	
3	7741	Nut	3	
4	10358	Brake pipe front - brake hose to caliper.	2	
5	1911	Brake hose rear.	1	
6	12064	Copper washer	1	
7	325153	Brake hoses aeroquip type, set with 3 lines.	1	
8	20031	Self tapping screw	1	
9	8694	Retaining clip brake pipe to bulkhead	1	
10	293620	Clip brake pipe to RH chassis rail	1	
11	3423	Retaining clip brake pipe to chassis	6	
12	8495	Hose clip brake pipe to rear axle - metal	2	} Alternatives
12	19842	Cable strap brake pipe to rear axle - plastic.	2	
13	200431	Foot valve brake union	1	} Use only, when brake master cylinder has no check valve fitted
14	11465	4 way brake union	1	
15	212451	Nyloc nut	1	
16	212191	Plain washer	1	
17	6514	Bolt brake union to chassis	1	
18	2395	Brake light switch mechanical.	1	} Fixed at pedal box
19	3813	Shakeproof washer	1	
20	3201	Nut	1	
21	9594	Bracket brake light switch	1	
22	3813	Shakeproof washer	1	
23	3201	Nut	1	
24	202318	Inline connector brake pipe	1	
25	26120	Brake pipe set LHD	1	



Brake fluid
Silicone DOT5

0.5 litre
Part no.12278

1 litre
Part no.12279

13.1

Road wheels

Wheels

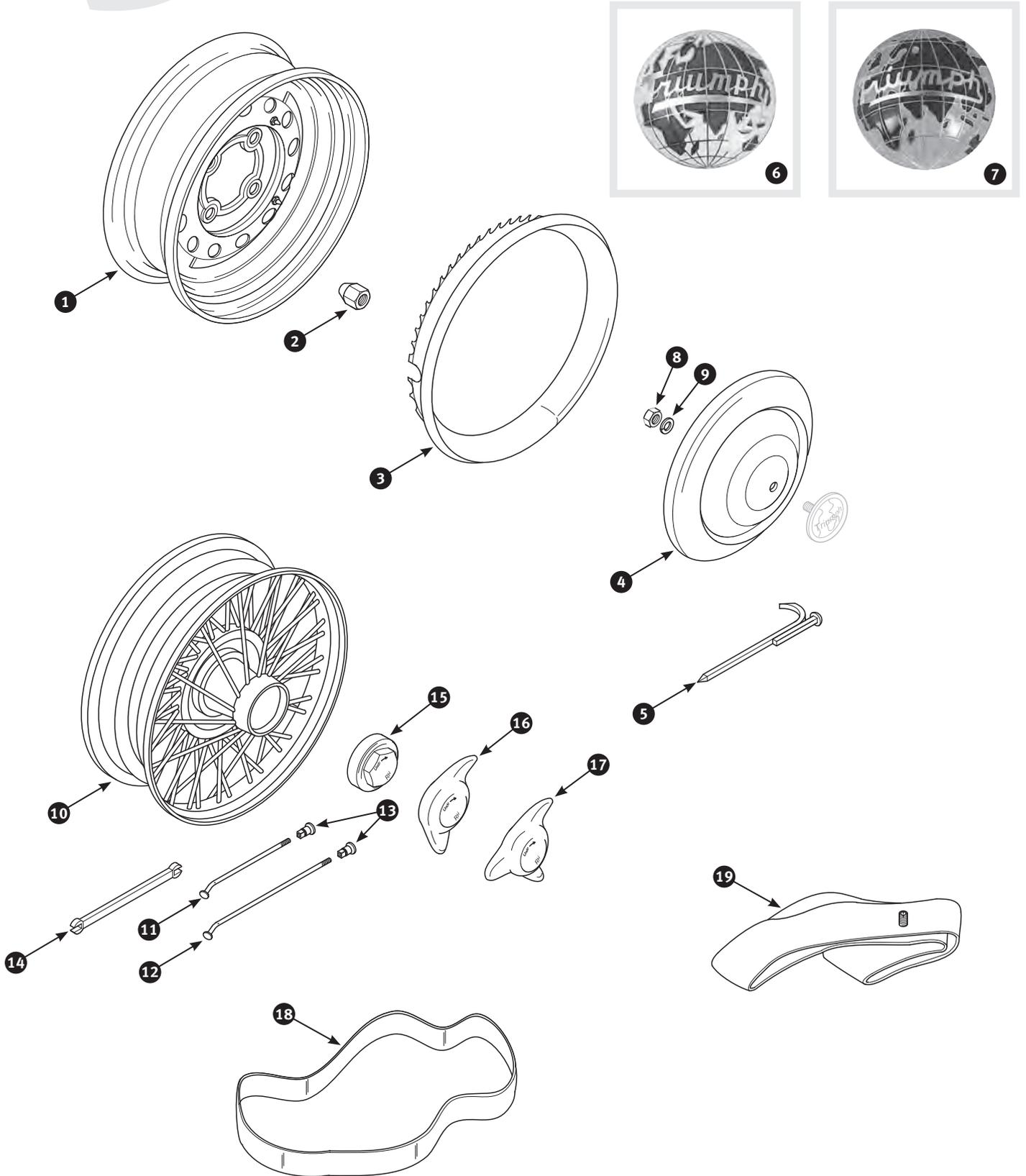

No	Part No	Description	Qty	Notes
1	203935	Disc wheel 4.0 x 15"	5	} TR2, TR3 to TS13045
1	300704	Disc wheel 4.5 x 15"	5	
2	4983	Wheel nut	16	} TR3 from TS13046, TR3A, TR3B, TR4 and TR4A
3	21095	Wheel trim ring stainless steel	4	
4	331	Hub cap chromed	4	
5	18145	Tool for hub cap removal	1	
6	11290	Medallion hub cap - enamelled	4	} TR2, TR3 to TS13045 Alternatives
7	247	Medallion hub cap - painted	4	
8	215477	Nut medallion to hub cap	4	} TR3 from TS13046, TR3A Alternatives
9	212190	Spring washer	4	
10	215191	Wire wheel chromed, rim size: 4.0J x 15", number of spokes: 48	5	} For further information see chapter 21.18
10	2726	Wire wheel painted, rim size: 4.0J x 15", number of spokes: 48	5	
10	1595	Wire wheel chromed, rim size: 4.5J x 15", number of spokes: 60	5	
10	2021	Wire wheel painted, rim size: 4.5J x 15", number of spokes: 60	5	
11	326195	Spoke stainless steel - short	0	
11	9260	Spoke unpainted - short	0	
12	326196	Spoke stainless steel - long	0	
12	19057	Spoke unpainted - long	0	
11	326193	Spoke stainless steel - short	0	
11	326185	Spoke unpainted - short	0	
12	326194	Spoke stainless steel - long	0	
12	326186	Spoke unpainted - long	0	
13	290430	Nipple stainless steel	0	} Quantity as required
13	9254	Nipple unpainted	0	
14	11321	Spoke wrench for tightening spokes	1	
15	1223	Octagonal spinner RH	2	
15	9373	Octagonal spinner LH	2	
16	614	Spinner RH, 2 eared	2	
16	615	Spinner LH, 2 eared	2	
17	9743	Spinner RH, 3 eared	2	
17	9746	Spinner LH, 3 eared	2	
18	336225	Rim band to fit 15" wheels	5	
19	205290	Inner tube 165 x 15"	5	
19	206365	Inner tube 185 x 15"	5	

**Tuning catalogue:
All wire wheels**

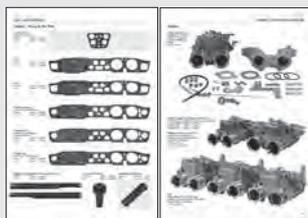

Wheel packages

chromed, 5.5J x 15" with 72 spokes.
Tyre: 185/80HR15 93H Michelin XVS-P
Part no.485487

chromed, 5.5J x 15" with 72 spokes.
Tyre: 185/80HR15 Vredestein Sprint Classic
Part no.485488

chromed, 5.5J x 15" with 72 spokes.
Tyre: 185/70HR15 Vredestein Sprint Classic
Part no.485489



13.2

Road wheels

Jack and tools

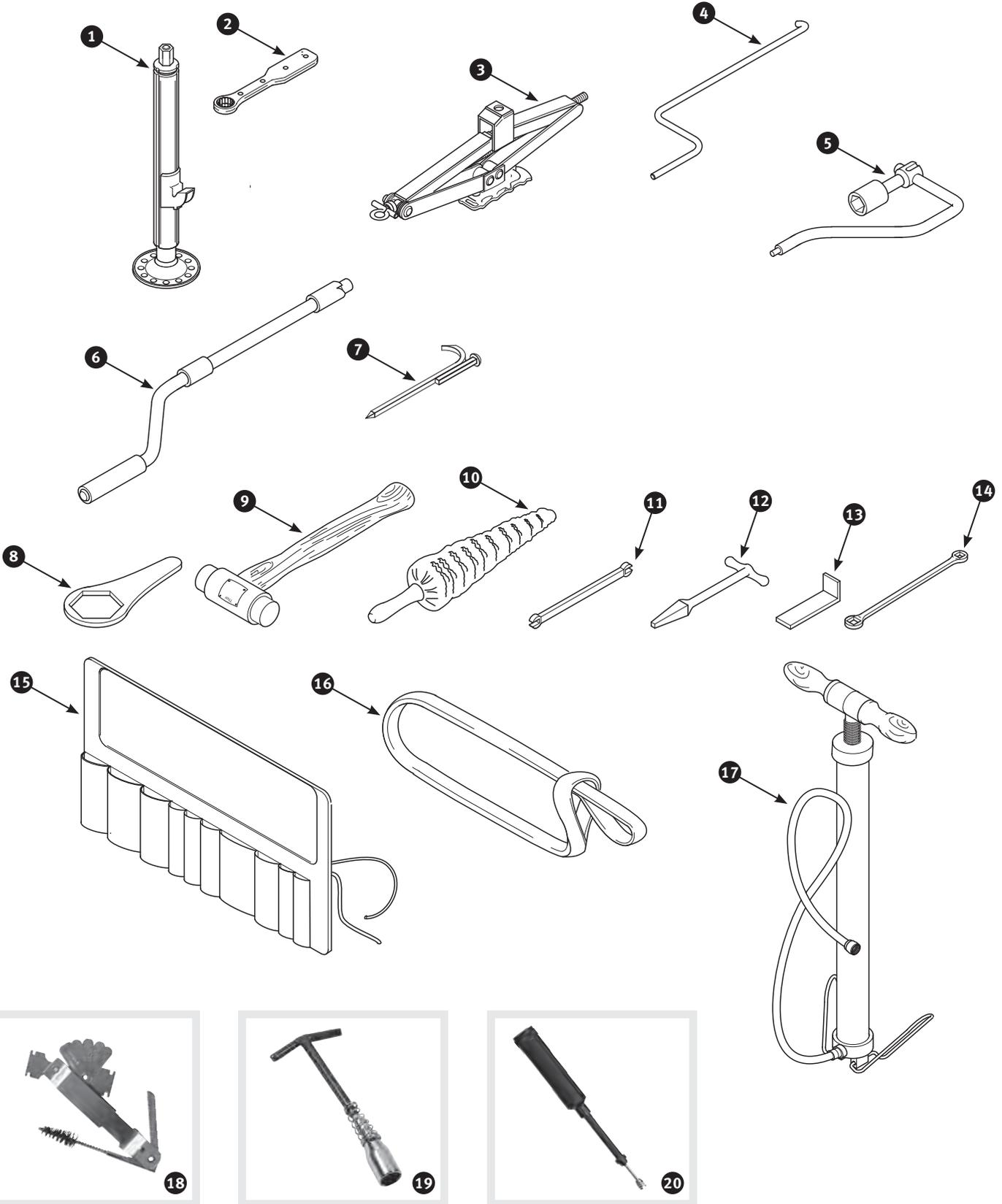

No	Part No	Description	Qty	Notes
1	300414	Jack	1	} TR2 to TS5468. May be replaced by jack 19072
1	19072	Jack	1	
2	470250	Ratchet for jack	1	} TR2 from TS5469, TR3, TR3A, TR3B and TR4
3	289983	Jack original style	1	
3	310517	Jack replacement	1	} TR4A
4	10816	Wrench for jack	1	
5	9877	Wheel brace	1	
6	11297	Starting handle	1	} TR2 and TR3
6	11298	Starting handle	1	
6	11302	Starting handle	1	} TR3A and TR3B
7	18145	Tool for hub cap removal	1	
8	671	Spanner for octagonal spinners	1	} TR4
9	878	Thor Hammer copper/hide, weight: 1000 g.	1	
9	2183	Thor Hammer lead alloy, weight: 1000 g.	1	
10	7339	Spoke brush	1	
11	11321	Spoke wrench for tightening spokes	1	
12	10280	Square key to secure wheel spats, side screens bonnets and boot lids.	1	
13	8233	Puller for headlamp rim	1	
14	7356	Brake adjust spanner square, with closed ends	1	
15	19075	Tool roll coated jute.	1	} TR2 and TR3
15	25902	Tool roll vinyl	1	
16	21123	Strap for spare wheel removal	1	} TR3A, TR3B, TR4 and TR4A
17	326151	Air pump	1	
18	319923	Ignition electrode tool 4 in 1 kit	1	} For further information see chapter 21.30
19	305567	Spark plug wrench for spark plugs with 14 mm thread	1	
20	258249	Grease gun double action tool, 100 ml	1	

On board tool kit

contents: 7 combination AF spanner, combination pliers, spark plug wrench, circuit tester, reversible screw driver and feeler gauge. Comes with a vinyl tool roll

Part no. 345595



14.1

Electrics

Dynamo

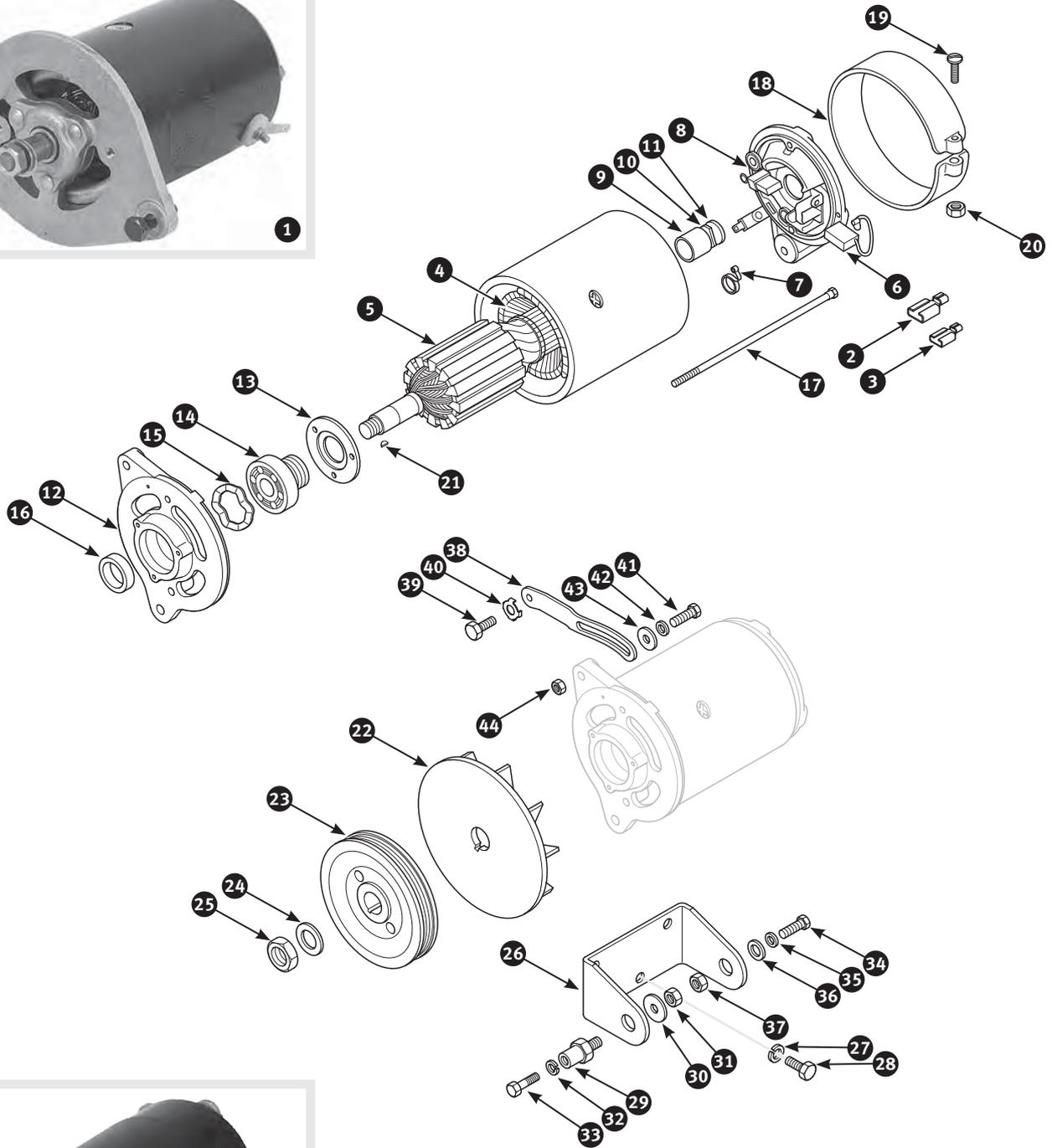

No	Part No	Description	Qty	Notes
1	297097	Dynamo with screwed terminals and cover band over brush gear - stamped: Lucas 22258D	1	} TR2, TR3 to TS9842. May be replaced by dynamo 20957
1	298921	Dynamo screwed terminals and solid case - stamped: Lucas 22258E or 22258F	1	
1	289817	Dynamo with lucar terminals and solid case - stamped: Lucas 22700 or 22704	1	} TR3 from TS9843, TR3A to TS60000. May be replaced by dynamo 20957
1	300874	Dynamo with lucar terminals and solid case - stamped: Lucas 22715	1	
1	20957	Dynamo - exchange	1	} TR3A from TS60001, TR3B and TR4. May be replaced by dynamo 20957
1	290509	Dynamo - new item	1	
2	9149	Connector 3/8"	1	} TR4A. May be replaced by dynamo 20957
3	14779	Connector 1/4"	1	
4	300323	Field coil set	1	} Replacement unit, fits all models
4	11366	Field coil set	1	
5	18533	Armature	1	} To fit replacement dynamos 20957 and 290509 to early cars with screwed terminals
6	202919	Brush set	1	
6	3179	Brush set	1	} TR2, TR3, TR3A to TS60000 with Lucas dynamo stamped: 22258
7	10716	Compression spring for brush set	2	
8	300320	Bracket commutator end	1	} TR3A from TS60001, TR3B, TR4 and TR4A
8	9148	Bracket commutator end	1	
9	9280	Bronze bush	1	} TR2, TR3, TR3A to TS60000 with Lucas dynamo stamped: 22258
10	355633	Finishing clip for oilier	1	
11	9147	Oiler	1	} TR3A from TS60001, TR3B, TR4 and TR4A
12	290350	Bracket drive end	1	
12	8937	Bracket drive end	1	} TR2, TR3, TR3A to TS60000 with Lucas dynamo stamped: 22258
13	296542	Striker plate ball bearing	1	
14	12985	Ball bearing drive end	1	} TR3A from TS60001, TR3B, TR4 and TR4A
15	287641	Wavy washer	1	
16	297916	Distance collar	1	} TR2, TR3 to TS9842 with Lucas dynamo stamped: 22258D
17	311144	Bolt between brackets	2	
18	18545	Band cover	1	} TR2, TR3 to TS9842 with Lucas dynamo stamped: 22258D
19	12789	Screw securing band cover	1	
20	215477	Nut	1	} TR2, TR3 to TS9842 with Lucas dynamo stamped: 22258D
21	8129	Woodruff key	1	
22	321242	Fan blade for dynamos with 15 mm shaft	1	} TR2, TR3 to TS9842 with Lucas dynamo stamped: 22258D
22	209298	Fan blade for dynamos with 17 mm shaft	1	
23	216198	Pulley dynamo	1	} TR2, TR3 to TS9842 with Lucas dynamo stamped: 22258D
24	2215	Spring washer	1	
25	7742	Nut pulley to dynamo	1	} TR2, TR3 to TS9842 with Lucas dynamo stamped: 22258D
26	21053	Bracket dynamo	1	
27	212194	Spring washer	3	} TR2, TR3 to TS9842 with Lucas dynamo stamped: 22258D
28	7877	Screw dynamo bracket to engine	3	
29	17287	Pedestal dynamo to bracket	1	} TR2, TR3 to TS9842 with Lucas dynamo stamped: 22258D
30	212197	Plain washer	1	

14.1

Electrics

Dynamo

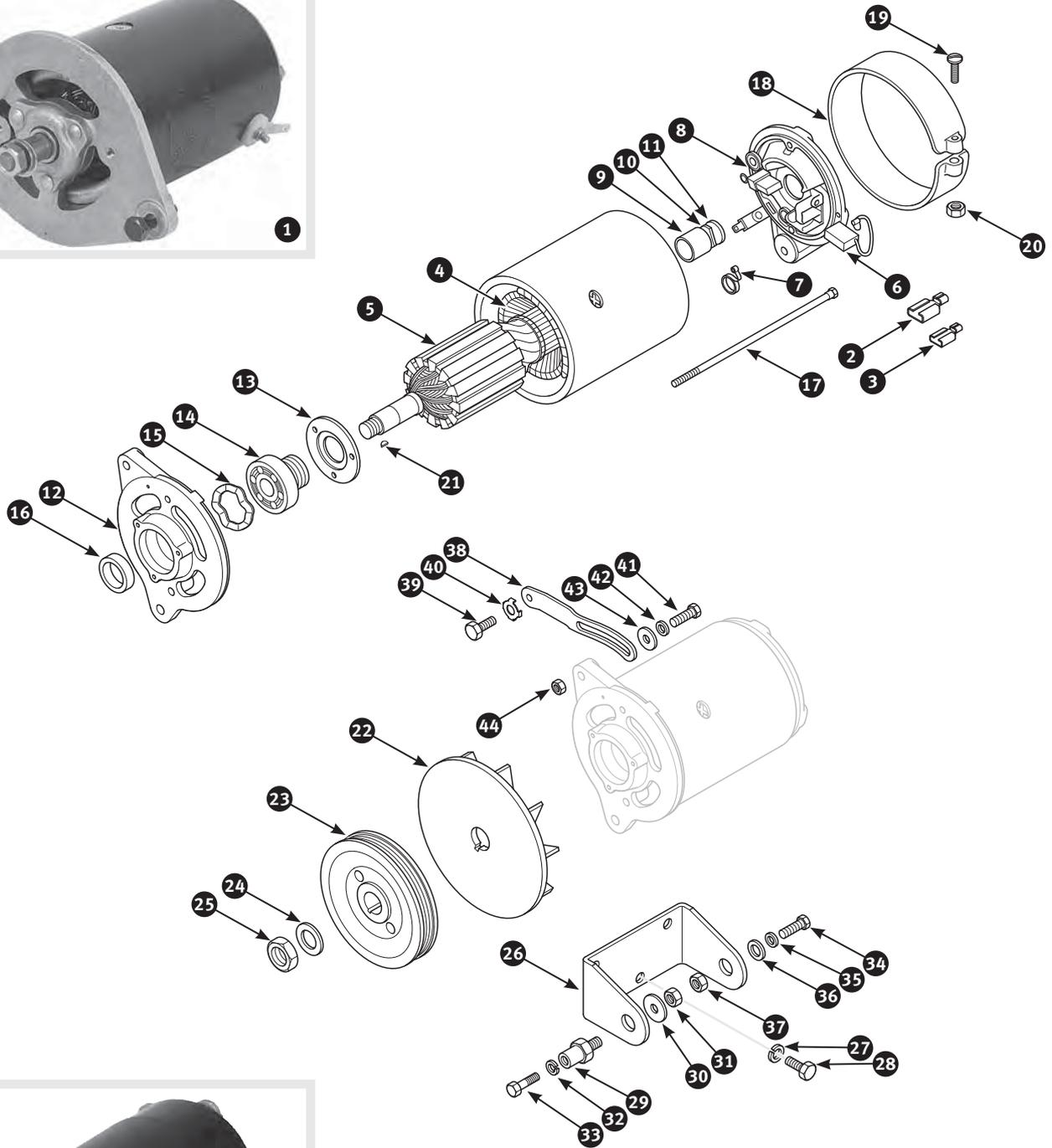

No	Part No	Description	Qty	Notes
31	212113	Nyloc nut pedestal to dynamo bracket.	1	
32	212194	Spring washer	1	
33	9179	Bolt dynamo to pedestal	1	
34	6521	Bolt dynamo to bracket	1	
35	212193	Plain washer - small	1	
36	9204	Plain washer - large.	1	
37	2049	Nyloc nut dynamo to bracket	1	
38	215608	Adjusting link dynamo	1	
39	212167	Screw adjusting link to water pump housing	1	
40	20835	Lock tab	1	
41	212169	Screw adjusting link to dynamo	1	
42	10488	Plain washer - thickness: 0.060".	1	
43	10487	Plain washer - thickness: 0.057".	1	
44	317631	Steel nut adjusting link to dynamo	1	
45	479752	Alternator conversion in the original Lucas look	1	} For further information see chapter 21.23

Conversion kit

to narrow fan belt. Containing 3 pulleys and 1 fan belt. This conversion runs with the original fan, an electric fan is not necessary

Part no. 15523

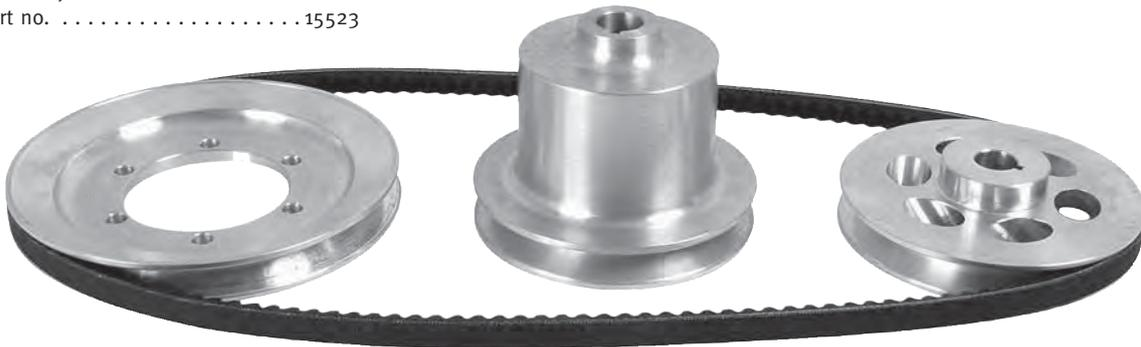

For further information see chapter 21.5

Order free of charge:

Tools catalogue

Order free of charge:

Tuning catalogue

Order free of charge:

Oils and lubricants catalogue

Order free of charge:

Accessories catalogue

14.2

Electrics

Starter motor

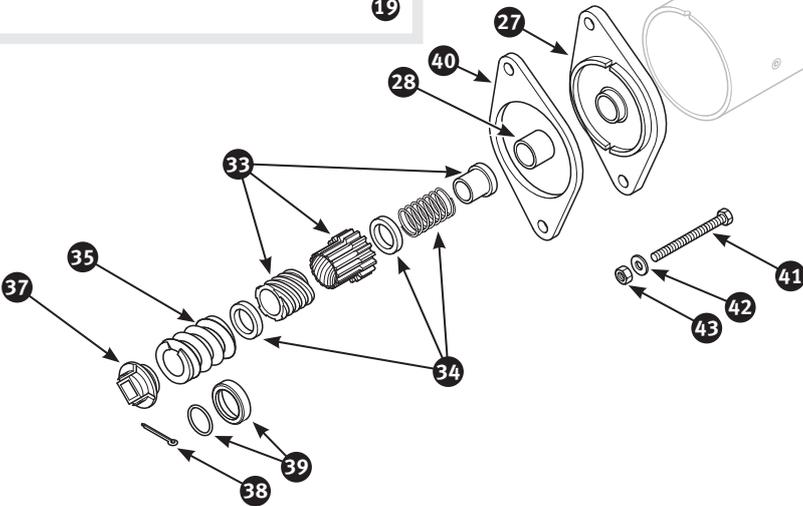
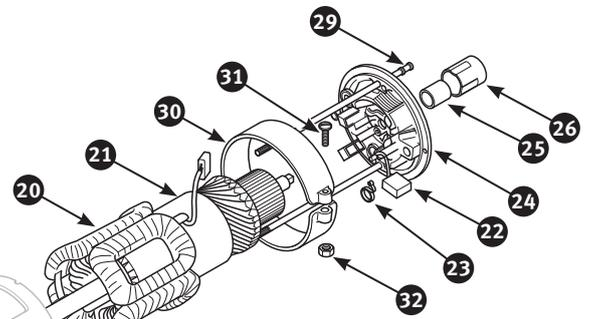
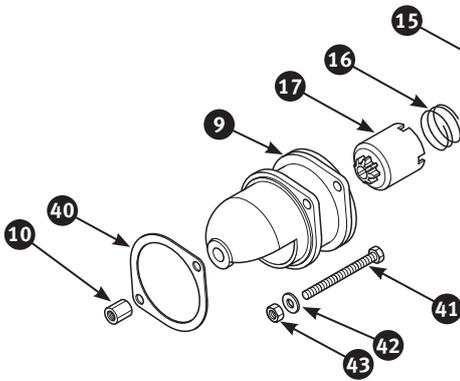
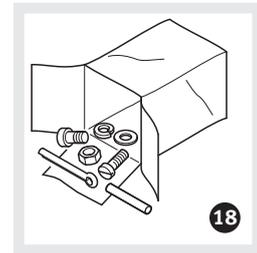
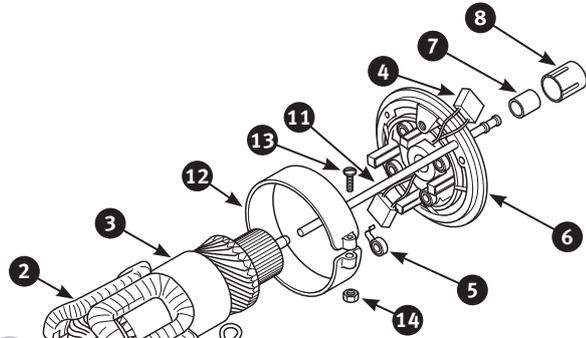

No	Part No	Description	Qty	Notes
1	11412	Starter motor ,bomb type' - exchange. Identify by a 91 tooth ring gear shrunk onto the flywheel	1	TR2, TR3, TR3A to TS50000
2	297830	Field coil set	1	
3	300345	Armature	1	
4	2682	Brush set	2	
5	4692	Spring brush tension	4	
6	213047	Bracket commutator end	1	
7	2334	Bronze bush commutator end bracket	1	
7	213090	Bronze bush commutator end bracket, oversize type for worn cast shafts	1	
8	11800	Cap armature shaft	1	
9	337448	Bracket drive end	1	
10	212937	Bronze bush drive end bracket	1	
10	213091	Bronze bush drive end bracket, oversize type for worn cast shafts .	1	
11	214338	Bolt through brackets	2	
12	18545	Band cover	1	
13	12789	Screw securing band cover	1	
14	215477	Nut	1	
15	11239	Coupling for starter pinion	1	
16	290857	Spring for starter pinion	1	
17	201907	Starter pinion with 9 teeth	1	
18	3445	Sundries kit starter motor	1	
19	14286	Starter motor ,long type' - exchange. Identify by a 90 tooth ring gear bolted to the flywheel	1	TR3A from TS50001, TR3B, TR4 and TR4A
20	297830	Field coil set	1	
21	21032	Armature for genuine M418G type starter motor	1	
22	2682	Brush set for genuine M418G type starter motor	2	
22	7516	Brush set for replacement 2M100 type starter motor	2	
23	4692	Spring brush tension	1	
24	213047	Bracket commutator end	1	
25	2334	Bronze bush commutator end bracket	1	
25	213090	Bronze bush commutator end bracket, oversize type for worn cast shafts	1	
26	11800	Cap armature shaft	1	
27	304301	Bracket drive end	1	
28	212937	Bronze bush drive end bracket	1	
28	213091	Bronze bush drive end bracket, oversize type for worn cast shafts .	1	
29	214338	Bolt through brackets	2	
30	18545	Band cover	1	
31	12789	Screw securing band cover	1	
32	215477	Nut	1	
33	10852	Starter pinion with 10 teeth	1	
34	21036	Springs for starter pinion - supplied in pairs	1	
35	11309	Main spring starter pinion	1	
36	3445	Sundries kit starter motor	1	
37	21037	Nut	1	TR3A from TS50001, TR3B, TR4 und TR4A - 2M100 starter motor armature shaft with thread
38	10477	Split pin on nut	1	
39	21038	Circlip with cup washer	1	TR3A from TS50001, TR3B, TR4 and TR4A - M418G starter motor armature shaft without thread

14.2

Electrics

Starter motor

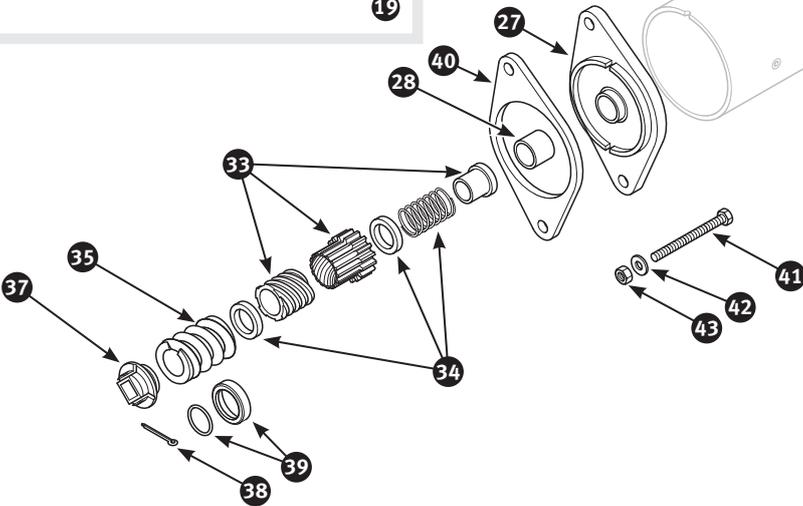
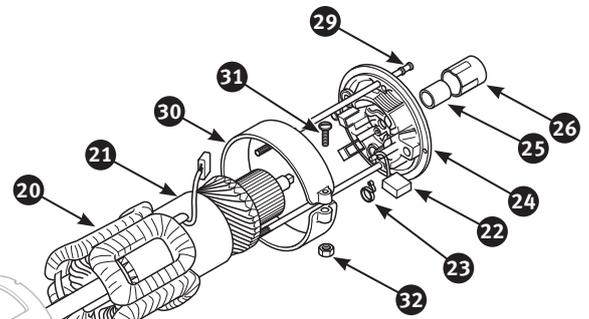
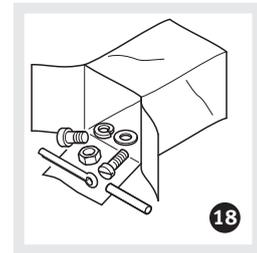
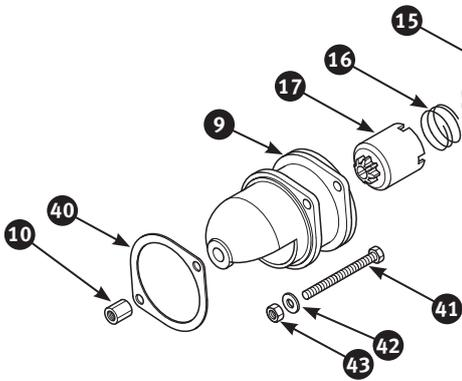
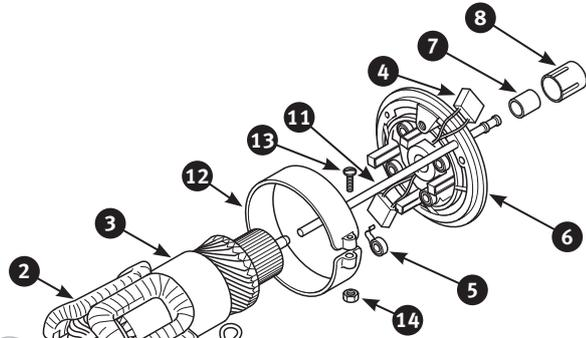

No	Part No	Description	Qty	Notes
40	21379	Spacing washer starter adjustment	0	} Quantity as required TR2, TR3, TR3A, TR3B and early TR4. Identify by 11 mm gearbox mounting flange
41	213890	Bolt starter motor to gearbox	2	
41	15514	Bolt starter motor to gearbox	2	} late TR4, TR4A. Identify by 14 mm gearbox mounting flange
42	2051	Spring washer	2	
43	3073	Nut	2	
44	317415	High performance starter motor gear diameter: 35 mm, number of teeth: 9	1	} TR2, TR3, TR3A to TS50000 TR3A from TS50001, TR3B, TR4 and TR4A
44	316558	High performance starter motor gear diameter: 39 mm, number of teeth: 10.	1	

Elora Socket set (imperial)
with 1/2" square drive, 24 pieces.

- Contents:
- 18 bi-hexagon socket, 3/8" to 1.1/4" AF
 - 1 „Elotech“ reversible ratchet
 - 2 extension bars, 125 mm and 250 mm
 - 1 sliding tee bar
 - 1 universal joint
 - 1 speed brace
- Part no. 304157

Elora Socket set (metric)
with 1/2" square drive, 24 pieces.

- Contents:
- 18 bi-hexagon socket, 10 to 32 mm
 - 1 „Elotech“ reversible ratchet
 - 2 extension bars, 125 mm and 250 mm
 - 1 sliding tee bar
 - 1 universal joint
 - 1 speed brace
- Part no. 208529

Elora Socket set (Withworth)
with 3/4" square drive, 17 pieces.

- Contents:
- 11 bi-hexagon socket, 1/8" to 11/16" Withworth
 - 1 „Elotech“ reversible ratchet
 - 2 extension bars, 125 mm and 250 mm
 - 1 sliding tee bar
 - 1 universal joint
 - 1 speed brace
- Part no. 208528

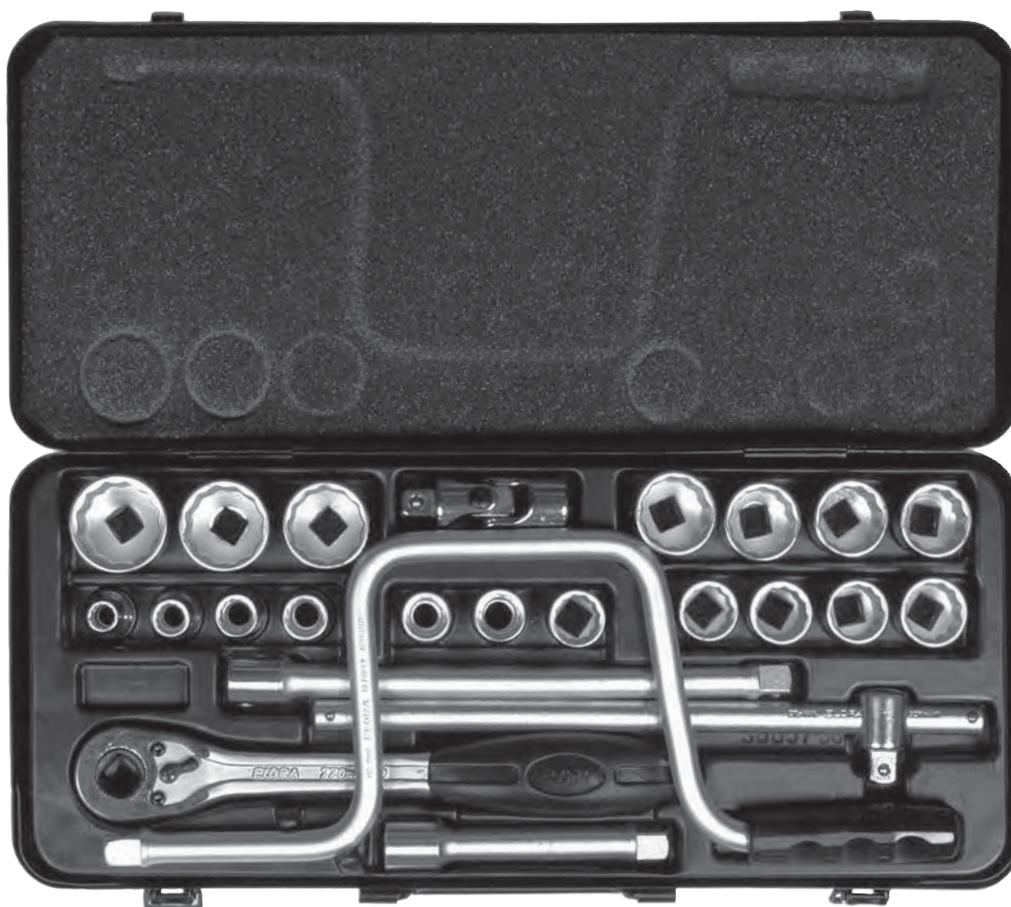

14.3

Electrics

Distributor

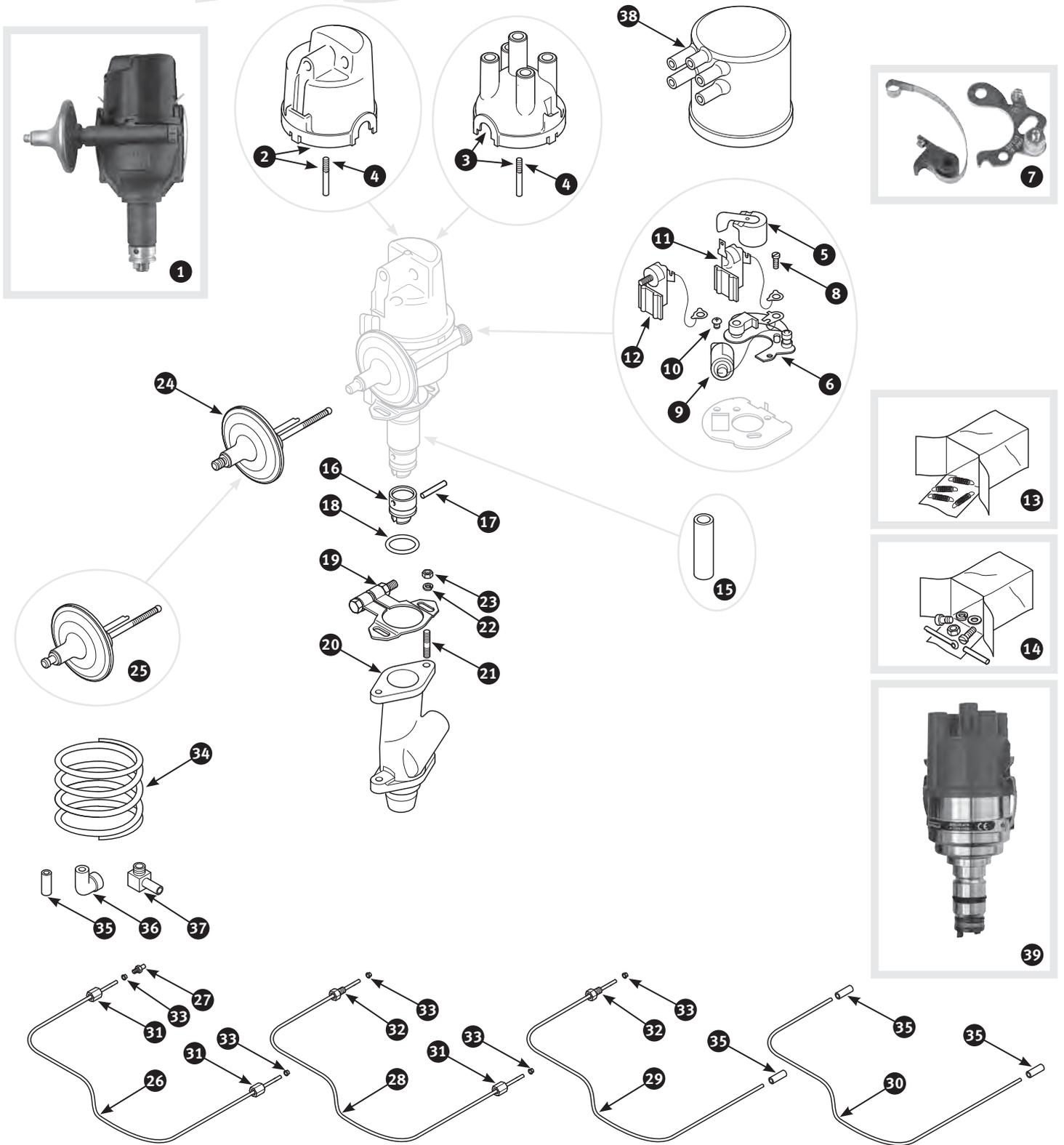

No	Part No	Description	Qty	Notes
1	21045	Lucas Distributor exchange. DM2P4 type, serial number: 40403 . . . 1	1	} TR2 to TS8212 - 83 mm engine
1	213196	Lucas Distributor exchange. DM2P4 type, serial number: 40480 . . . 1	1	
1	213198	Lucas Distributor exchange. DM2P4 type, serial number: 40698 . . . 1	1	} TR2 from TS8213, TR3 - 83 mm engine
1	21052	Lucas Distributor exchange. 25D4 type, serial number: 40850 1	1	
1	21049	Lucas Distributor exchange. 25D4 type, serial number: 40783 1	1	} TR3A, TR3B - 83 mm engine
1	213200	Lucas Distributor exchange. DM2P4 type, serial number: 40735 . . . 1	1	
1	21050	Lucas Distributor exchange. 25D4 type, serial number: 40795 1	1	} TR4 and TR4A - 83 mm engine
1	21051	Lucas Distributor exchange. 25D4 type, serial number: 40842 1	1	
2	14792	Distributor cap side entry 1	1	} Replacement for all 83 mm engines
3	3568	Distributor cap top entry 1	1	
4	11359	Contact with spring 1	1	} TR3A, TR3B, TR4 to CT17953 - 86 mm engine
5	2676	Rotor arm 1	1	
6	11569	Contact set 1	1	} TR4 from CT17954, TR4A - 86 mm engine
6	201033	Contact set 1	1	
7	3467	Contact set competition type 1	1	} TR4A - 86 mm low compression engine
8	7399	Screw retaining contact set. 1	1	
9	2683	Condenser 1	1	
10	7519	Screw retaining condenser 1	1	
11	297583	Low tension lead with screw terminal 1	1	} For distributor 40403
12	18175	Low tension lead with lucar terminal 1	1	
12	4981	Low tension lead with lucar terminal 1	1	} For all distributors except 40403
13	13522	Auto advance springs - supplied in set of 5 1	1	
14	19737	Sundries kit 1	1	
15	11249	Bush distributor drive 1	1	
16	19251	Drive dog 1	1	
17	19933	Peg drive dog to distributor shaft 1	1	
18	10426	,O' ring distributor. 1	1	
19	8987	Clamping plate distributor to housing 1	1	
20	1646	Housing - new item made from cast iron 1	1	} For DM2P4 distributor
20	215035	Housing - used item 1	1	
20	337600	Housing - new item made from aluminium. 1	1	
21	19548	Stud 2	2	} For 25D4 distributor
22	212192	Spring washer 2	2	
23	2828	Nut 2	2	
24	300359	Vacuum unit for screw on vacuum pipe 1	1	} Distributor and tachometer drive
24	300357	Vacuum unit for screw on vacuum pipe 1	1	
25	300358	Vacuum unit for push on vacuum pipe. 1	1	} For distributor 40403
25	16874	Vacuum unit for push on vacuum pipe. 1	1	
26	21058	Vacuum pipe with two female fittings 1	1	} For distributor 40480 and 40698
27	1799	Adaptor vacuum pipe to carburettor 1	1	
28	21059	Vacuum pipe with one male and one female fitting. 1	1	} For distributor 40735 and 40795
29	21060	Vacuum pipe with one male and one push on fitting. 1	1	
30	21061	Vacuum pipe with two push on fittings 1	1	} For distributor 40783, 40842 and 40850
				} Cars with SU-H4 carburettors
				} Cars with SU-H6 carburettors
				} Cars with SU-HS6 or Zenith Stromberg 175CD carburettors

14.3

Electrics

Distributor

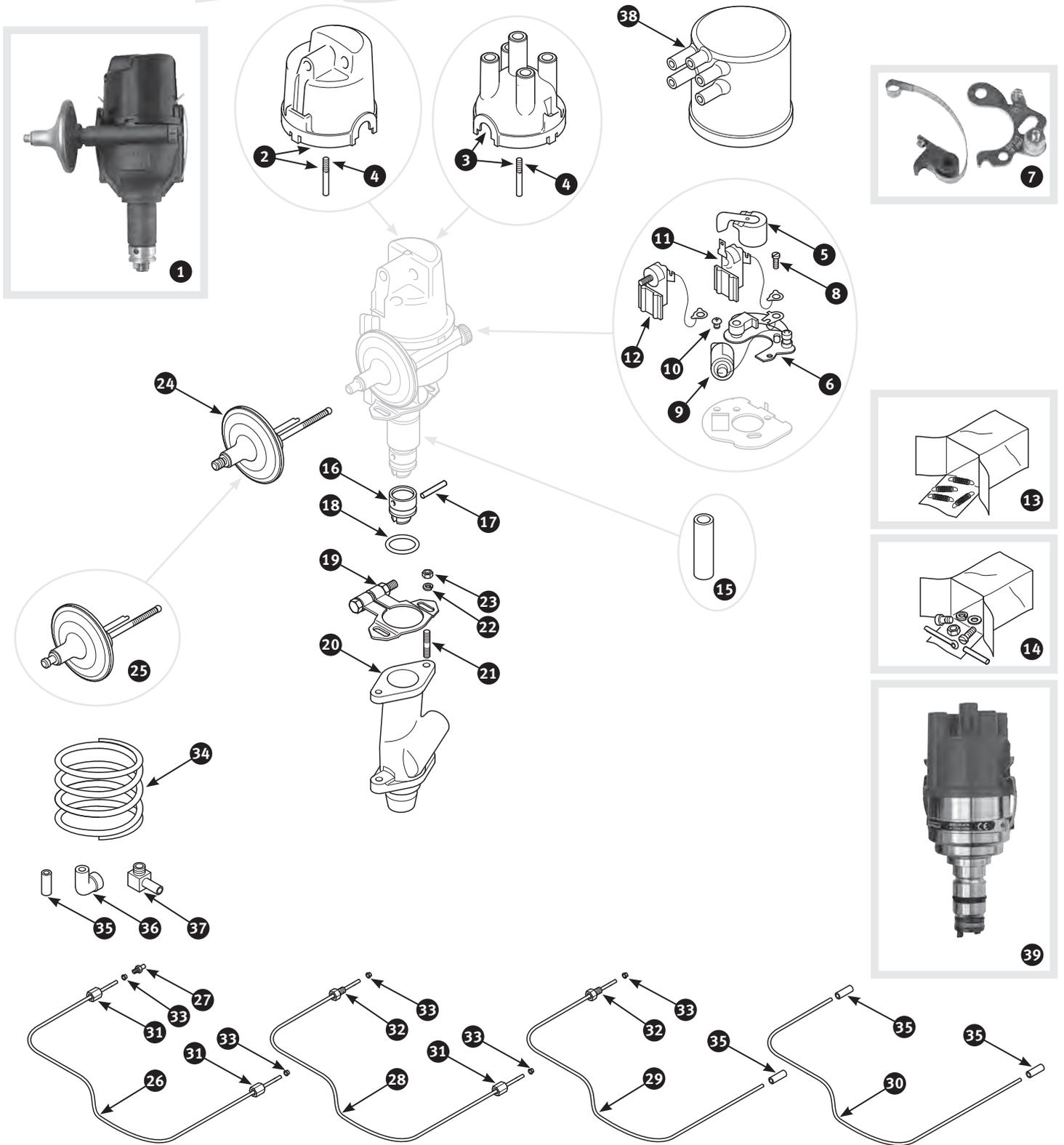

No	Part No	Description	Qty	Notes
31	315835	Female union vacuum pipe.....	0	Quantity as required
32	202315	Male union vacuum pipe.....	0	
33	202334	Olive vacuum pipe.....	0	
34	9048	Vacuum hose - pre cut to 1 metre.....	1	Alternative for all variants
35	5002	Connector vacuum hose, straight.....	0	
36	8287	Connector vacuum hose - 90° angled.....	1	Cars with SU-HS6 carburetors
37	21062	Connector vacuum hose - 90° angled.....	1	
38	9312	Rubber cover for distributor with side entry.....	1	Cars with Zenith Stromberg 175CD carburetors
39	485462	123 Ignition system top entry type.....	1	
39	295886	123 Ignition system side entry type.....	1	

That's not a distributor!

- Less emissions
- Better starting
- Maintenance-free
- Simple installation
- Variable dwell-angle
- Lower fuel consumption
- Attractive "original" look
- Stronger spark at all speeds
- Smooth engine torque curve
- Easy timing: with built-in LED
- Spark balancing: less noise & more power
- 16 user selectable electronic advance curves
- Available for 4, 6, 8 and 12 cylinder engines

Buy a 123 ignition now! Enjoy today's standards of reliability and performance. Join the rapidly growing group of trouble-free classic car owners. 123 ignition distributors are available for many engines!

Introducing the "123 ignition"

The ignition-system in a classic car is often the source of many problems. After years of use, the mechanical distributor becomes worn and increasingly inaccurate.

Although replacement of the standard points with an optical eye or magnetic ignition set-up is an improvement, it does not compensate for the wear in the advance-mechanism, the distributor shaft and bearings within the distributor itself.

The 123 ignition distributor is different. It comes in its own aluminium billet and nickel plated housing, although externally similar in its classic appearance to its mechanical counterpart, it contains high-tech electronics on the inside. While maintaining classic appearances under the bonnet, the internal technology makes your ignition system and engine perform better than ever before.

The 123 ignition is only available for negative earth cars.

**Exclusive from us:
for 8 cylinder Rover engines**

123 Ignition system

side entry type

For 4 cylinder models with Lucas distributors, negative earth and electric tachometer

Part no.295886

select one of
16 advanced
curves



14.4

Electrics

Ignition coil, ignition leads and spark plugs

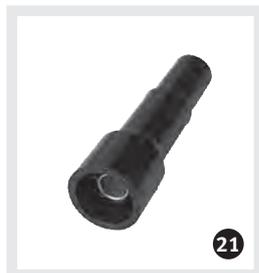
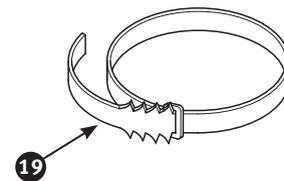
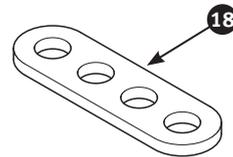
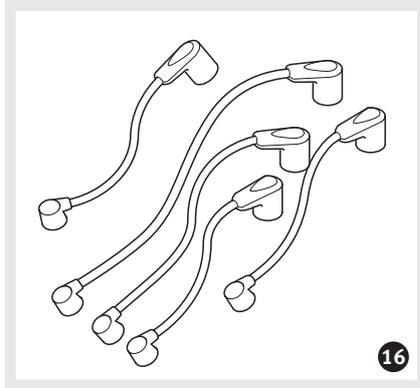
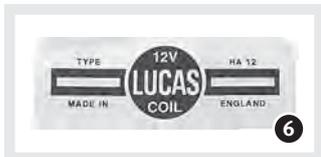
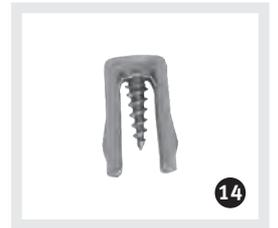
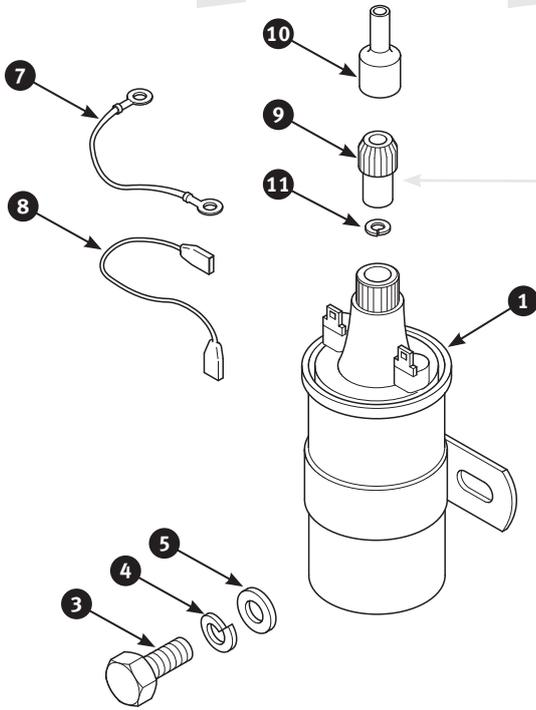

No	Part No	Description	Qty	Notes
1	258416	Ignition coil with screw-in HT lead terminal	1	
1	2646	Ignition coil with push-in HT lead terminal	1	
2	2422	Lucas High performance ignition coil with push-in HT lead terminal	1	
3	212153	Screw ignition coil to cylinder block	2	
4	212192	Spring washer	2	
5	7794	Plain washer	2	
6	14567	Sticker on ignition coil - 'Lucas'	1	
7	21063	Low tension lead with ring terminals	1	} TR2 and TR3, TR3A to TS60000
8	21064	Low tension lead with lucar terminals	1	
9	246106	Acorn nut ignition lead to coil	1	} Use on ignition coil with screw-in HT lead
10	202233	Terminal washer on acorn nut	1	
11	310887	Cover ignition lead	1	
12	290870	End kit ignition lead to coil	1	} Use on ignition coil with push-in HT lead
13	310906	Terminal ignition lead to coil	1	
14	316404	HT lead end screwed into cooper ignition lead	1	
15	8088	Ignition lead heavy duty, copper in silicone type - supplied per metre	0	} Quantity as required
16	317303	Ignition lead set standard type, for top entry cap	1	} For top entry distributor cap see chapter 14.3
16	290693	Ignition lead set high performance type, for top entry cap	1	
17	21068	Sticker on ignition lead - 'Firing order'	1	
18	8187	Guide ignition lead	1	
19	8444	Cable strap made from rubber	1	
20	480834	Champion Spark plug cap 90° angled - bakelite type	4	
20	336988	Spark plug cap 90° angled - bakelite type	4	
21	12442	Spark plug cap straight	4	
22	4793	NGK Spark plug cap 90° angled - fits directly to the spark plug	4	
23	12443	NGK Spark plug cap 45° angled - fits directly to the spark plug	4	
24	19937	Champion Spark plug	4	
25	12432	NGK Spark plug	4	

Gunson's Flash Test

simple spark plug and ignition tool.
Scale shows if spark travel is o.k.

Part no. 303508

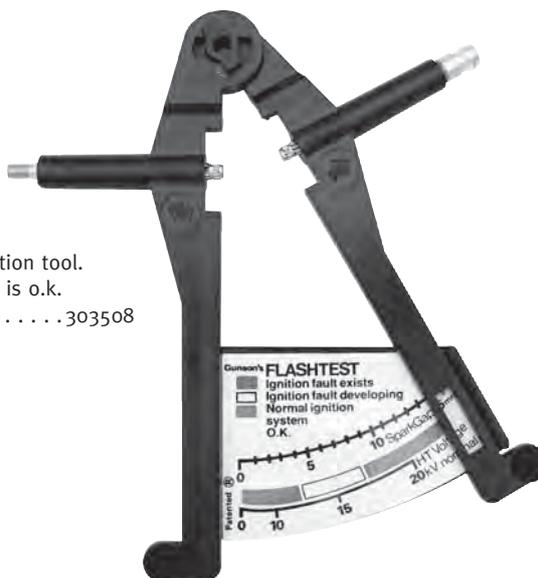

14.5

Electrics

Battery and fittings

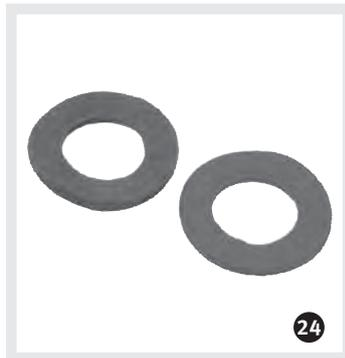
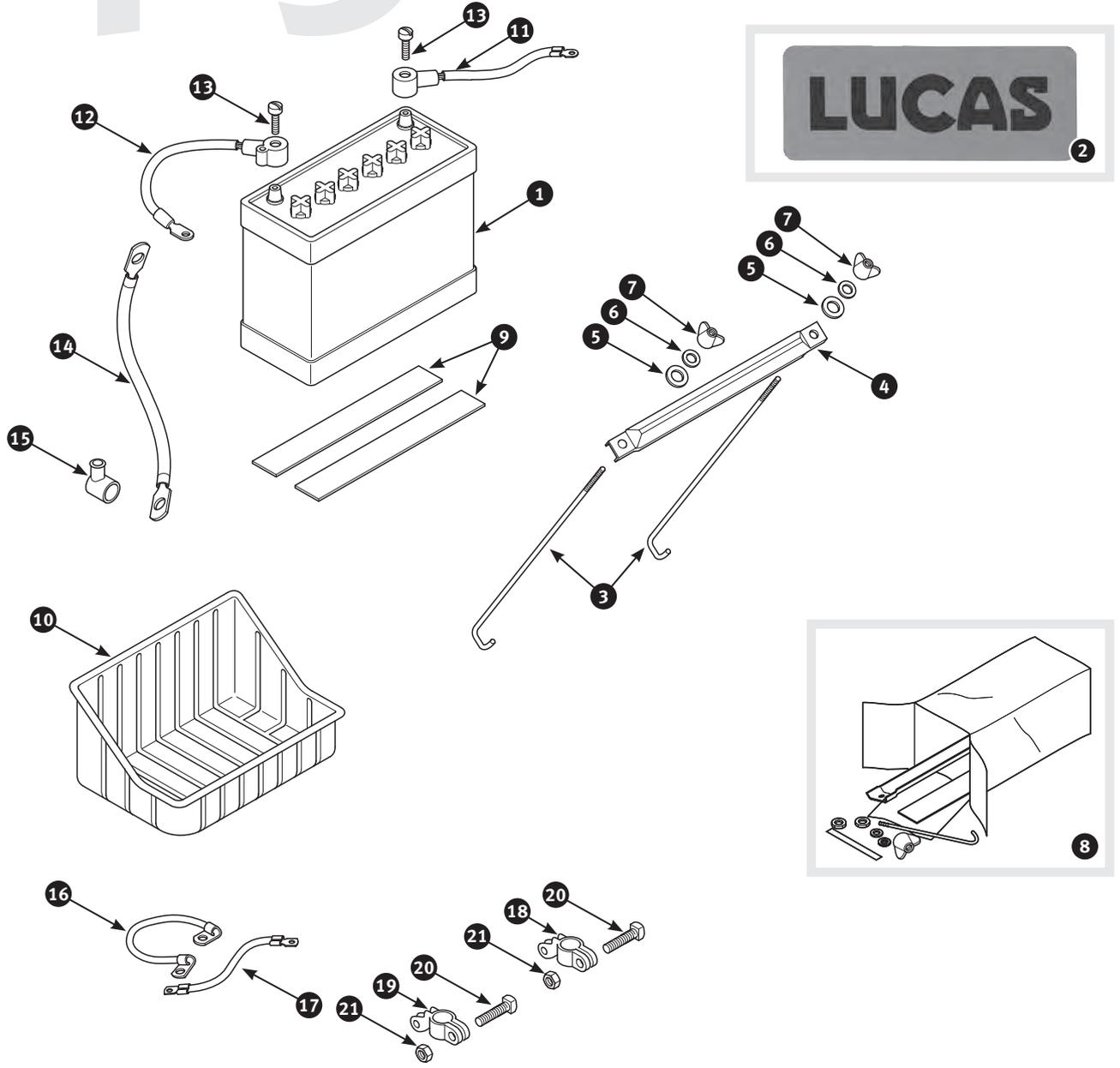

No	Part No	Description	Qty	Notes
1	19592	Battery with positive pole on LH side and negative pole on RH side.	1	12 V, 58 AH. Needed fixing bolts: 3531 (ill. 3)
1	316381	Battery with positive pole on RH side and negative pole on LH side.	1	
2	21569	Sticker on battery - ,Lucas'	1	
3	3531	,J' bolt battery hold - length: 8.25"	2	
3	2224	,J' bolt battery hold - length: 7"	2	
3	1828	,J' bolt battery hold - length: 5.75"	2	
3	405	,J' bolt battery hold - length: 4"	2	
4	15871	Retaining bar battery - hole centres: 12"	1	
4	407	Retaining bar battery - hole centres: 13"	1	
4	1330	Retaining bar battery - hole centres: 12.75"	1	} Heavy duty type
5	7794	Plain washer	2	
6	212192	Spring washer	2	
7	326451	Wing nut battery fixing.	2	
8	338028	Fitting kit battery - with 8.25" long ,J' bolts	1	
8	338029	Fitting kit battery - with 7" long ,J' bolts	1	
8	338030	Fitting kit battery - with 5.75" long ,J' bolts	1	
9	25071	Pad battery - rubber	4	} Use two stacks of two TR2, TR3, TR3A and TR3B
10	16942	Battery box plastic.	1	
10	16943	Battery box plastic.	1	} TR4 and TR4A
11	11573	Battery cable positive pole to body.	1	
12	11615	Battery cable negative pole to solenoid.	1	} Positive earth cars
11	19289	Battery cable negative pole to body	1	
12	19290	Battery cable positive pole to solenoid	1	} Negative earth cars
13	8730	Screw cap type terminal.	2	
14	16161	Cable solenoid to starter motor	1	
15	209386	Rubber cover solenoid and starter motor terminal insulating	3	
16	11616	Earth cable engine to body.	1	
17	17942	Earth cable steering rack to chassis.	1	} TR4 and TR4A
17	1672	Earth cable flexible coupling on steering column	2	
18	13728	Terminal clamp negative battery pole	1	} Cable diameter: up to 9 mm
19	13729	Terminal clamp positive battery pole	1	
20	2094	Bolt battery terminal - square head.	2	
21	3782	Nut terminal bolt.	2	
22	479870	Battery terminals supplied in pairs. Speed power type in red and blue, for a quick changing of the battery without a tool.	1	
23	216298	Grease for battery terminals 100 g tube	1	
24	479848	Terminal protector rings supplied in pairs. Comes red and green, prevents oxidation	1	
25	343415	Battery mat neutralizes battery acid and protects your vehicle against corrosion. Size: 12" x 8"	1	

**The smartest battery charger on the planet !
Fully automatic high tech charger.**

C Tek Battery charger

Multi XS 3600 - for 12 volt batteries up to 120 AH, charging current: 0.8/3.6 A

Variant with Euro plug

Part no.479840

Variant with UK plug

Part no.373249

For further information see chapter 21.22.



14.6

Electrics

Internal electrics - horn, relays and switches

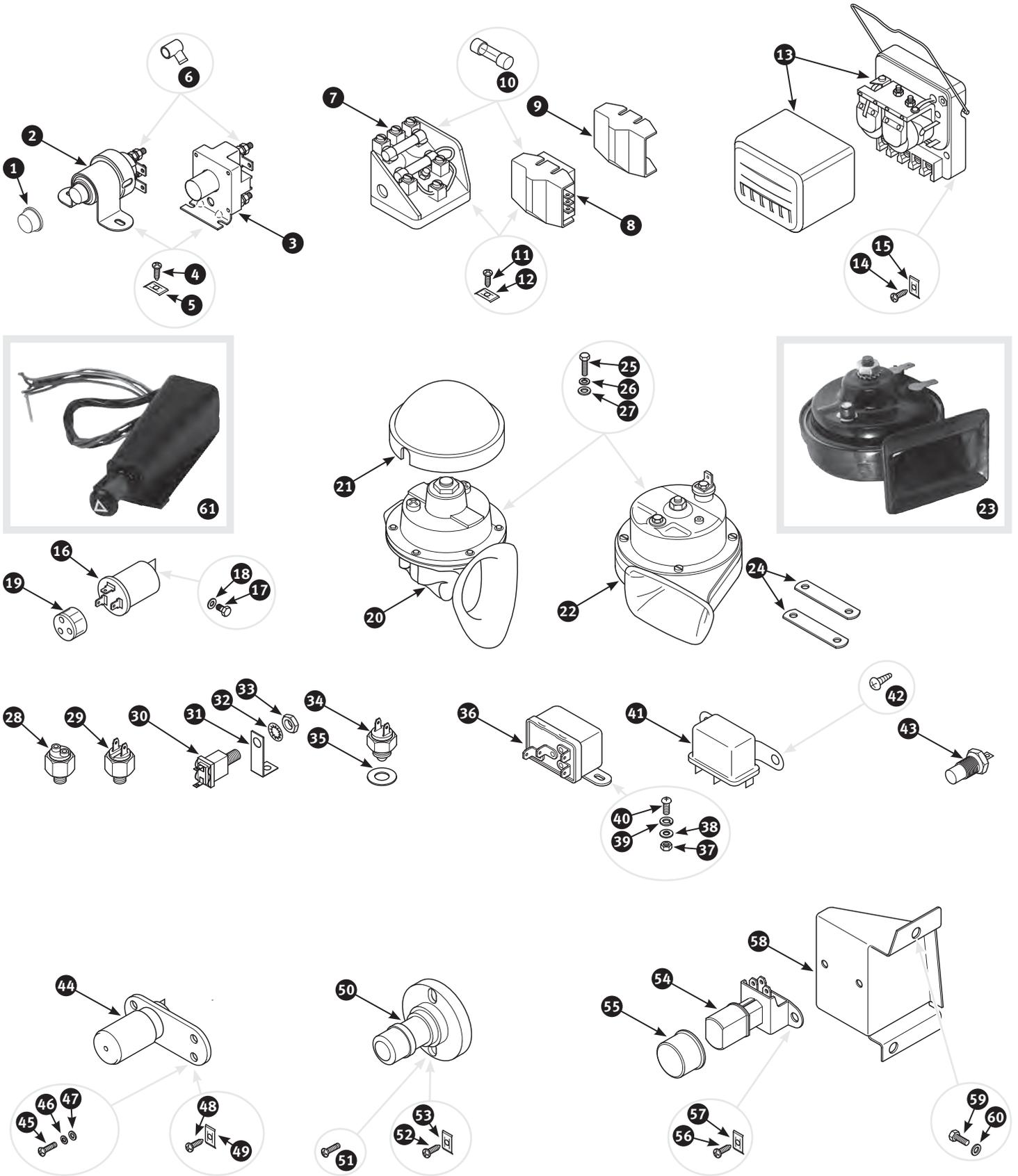

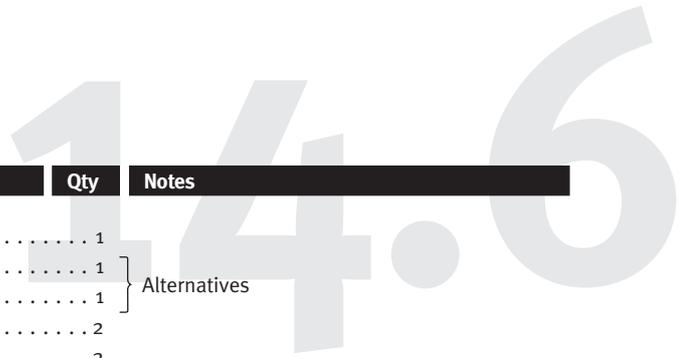

No	Part No	Description	Qty	Notes
1	18150	Rubber boot for push button solenoid.	1	
2	18149	Solenoid starter motor - push button type.	1	} Alternatives
3	5037	Solenoid starter motor - no push button	1	
4	3822	Self tapping screw solenoid to body	2	
5	3081	Spire nut	2	
6	209386	Rubber cover solenoid terminal insulating	2	
7	5382	Fuse box with screw-in terminals - type: SF6	1	} TR2 and TR3, TR3A to TS60000
8	212549	Fuse box with lucar terminals - type: 4F)	1	
9	11362	Lid fuse box - type: 4F)	1	} TR3A from TS60001, TR3B, TR4 and TR4A
10	15446	Fuse 35 ampere.	0	
10	15447	Fuse 50 ampere.	0	} Quantity as required
11	3822	Self tapping screw fuse box to body	2	
12	3081	Spire nut	2	
13	8985	Control box dynamo - with screw-in terminals, type: RB106	1	} TR2 and TR3, TR3A to TS60000
13	2825	Control box dynamo - with lucar terminals, type: RB603	1	
14	219029	Self tapping screw control box to body	2	} TR3A from TS60001, TR3B, TR4 and TR4A
15	3081	Spire nut	2	
16	204809	Flasher relay with 3 screw-in terminals	1	} Alternatives
16	3083	Flasher relay with 3 lucar terminals	1	
17	3120	Pointed screw flasher unit to body	1	
18	7794	Plain washer	1	
19	18985	Connector kit flasher unit	1	} TR4 and TR4A
20	316785	Horn low note - comes without domed cover	1	
20	8185	Horn high note - comes without domed cover	1	} TR2, TR3, TR3A and TR3B
21	325464	Cover for original horn - new item.	2	
21	203914	Cover for original horn - used item	2	
22	291203	Horn low note - type: 9H	1	} TR4 and TR4A
22	291204	Horn high note - type: 9H	1	
23	2821	Horn low note.	1	} Plastic replacement for all original horns. Require mounting bracket 21074 (ill. 24)
23	2820	Horn high note	1	
24	21074	Brackets horn - supplied in pairs	1	
24	21074	Brackets horn - supplied in pairs	1	} For replacement horns 2820 and 2821 (ill. 23)
25	3072	Screw horn to body.	4	
26	212192	Spring washer	4	
27	12821	Plain washer	4	
28	204816	Brake light switch hydraulic, with screw-in terminals.	1	} TR2, TR3 to TS13045 - cars with Lockheed brakes
29	200834	Brake light switch hydraulic, with lucar terminals	1	
29	17711	Brake light switch hydraulic, with lucar terminals	1	} TR3 from TS13045, TR3A and TR3B, TR4 to CT26929 - cars with Girling brakes
30	2395	Brake light switch mechanical.	1	
31	9594	Bracket brake light switch	1	} TR4 from CT26930, TR4A - fixed at pedal box
32	3813	Shakeproof washer	1	
33	3201	Nut	1	} If fitted
34	26256	Switch reverse light	1	
35	2449	Fibre washer on reverse light switch	2	} If fitted
34	26256	Switch overdrive isolation.	2	
35	2449	Fibre washer on overdrive switch	2	} Overdrive models only
36	204850	Relay overdrive - type: 6RA.	1	
37	10823	Panhead screw relay to body	2	
38	212190	Spring washer	1	
39	7793	Plain washer	2	
40	215477	Nut	2	

14.6

Electrics

Internal electrics - horn, relays and switches

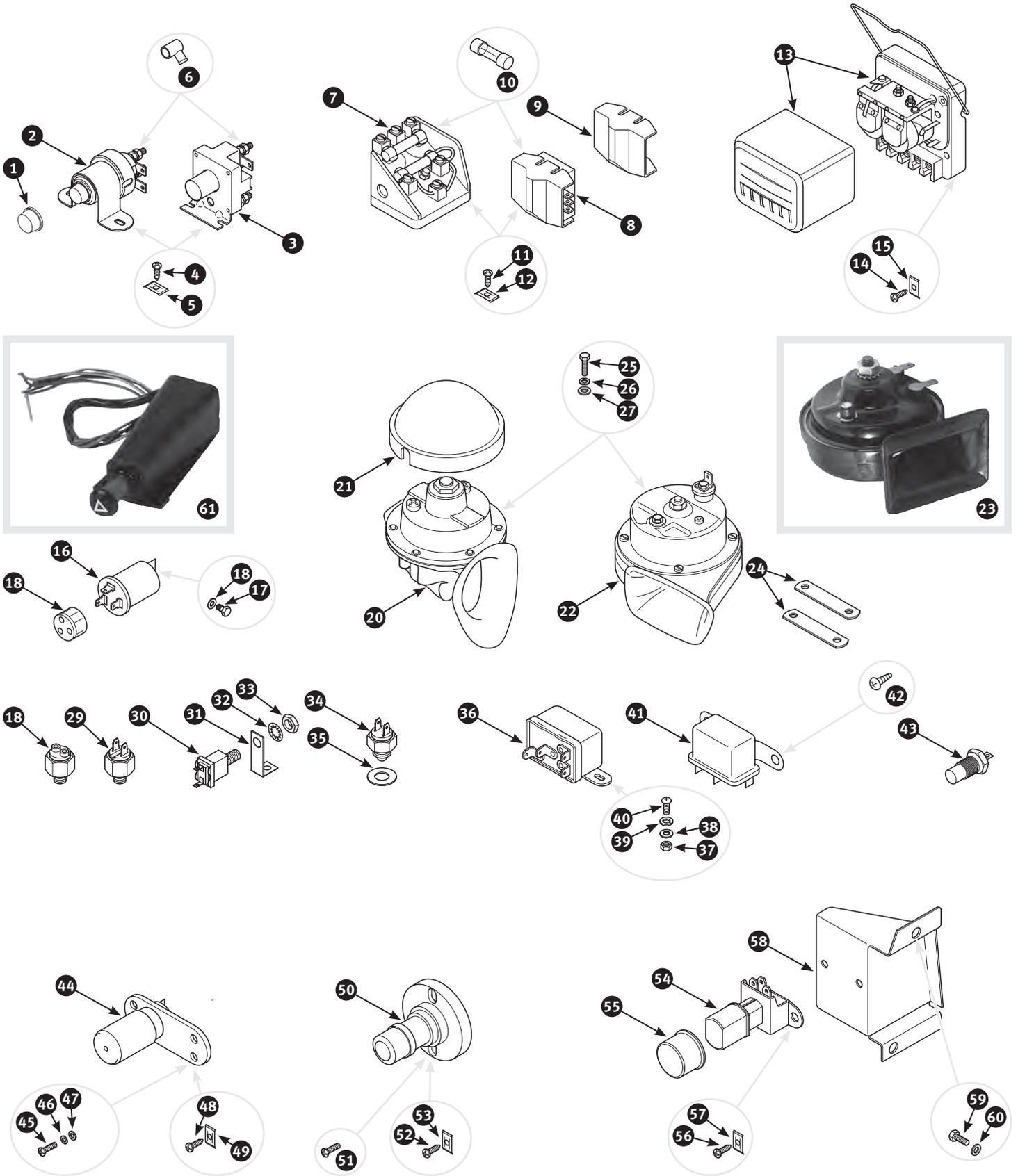

No	Part No	Description	Qty	Notes
41	204850	Relay horn - type: 6RA	1	} TR4A
42	3821	Self tapping screw relay to body	2	
43	2216	Thermal transmitter for temperature gauge - electrical	1	} TR4 and TR4A
44	8217	Foot dipper switch headlamp - type: FS22/1 with screw-in terminals	1	
45	13660	Panhead screw dip switch to bulkhead	2	} TR2 and TR3, TR3A to TS60000
46	212190	Spring washer	2	
47	7793	Plain washer	2	
48	5703	Self tapping screw dip switch to bulkhead	2	} TR2, TR3 to TS13045
49	318751	Spire nut	2	
50	9539	Foot dipper switch headlamps - round type: 21SA	1	} TR3 from TS13046, TR3A to TS60000
51	4661	Countersunk screw dip switch to bulkhead	2	
52	5703	Self tapping screw dip switch to bracket	2	} TR3A from TS60001 and TR3B and also early TR4 LHD
53	318751	Spire nut	2	
54	200671	Foot dipper switch headlamp - square type: 103SA	1	} Late TR4, TR4A
55	16034	Rubber cover dip switch	1	
56	214337	Panhead screw dip switch to bulkhead resp. to bracket	2	
57	318751	Spire nut	2	} TR4 and TR4A - LHD only
58	3020	Bracket dip switch - new item	1	
58	329603	Bracket dip switch - used item	1	} TR4 and TR4A - RHD only
59	212144	Screw bracket to bulkhead	2	
60	7793	Plain washer bracket to bulkhead	2	} TR4 and TR4A - RHD only
59	212144	Screw blanking hole	2	
60	7793	Plain washer blanking hole	2	} For further information see chapter 21.21
61	287383	Hazard warning kit for positive and negative earthed cars	1	

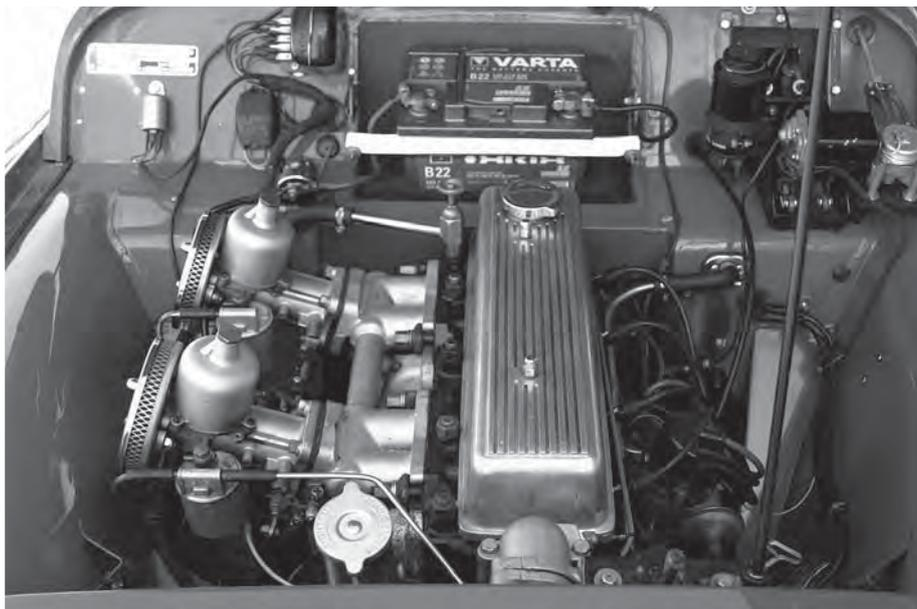

14.7

Electrics

Wiring loom

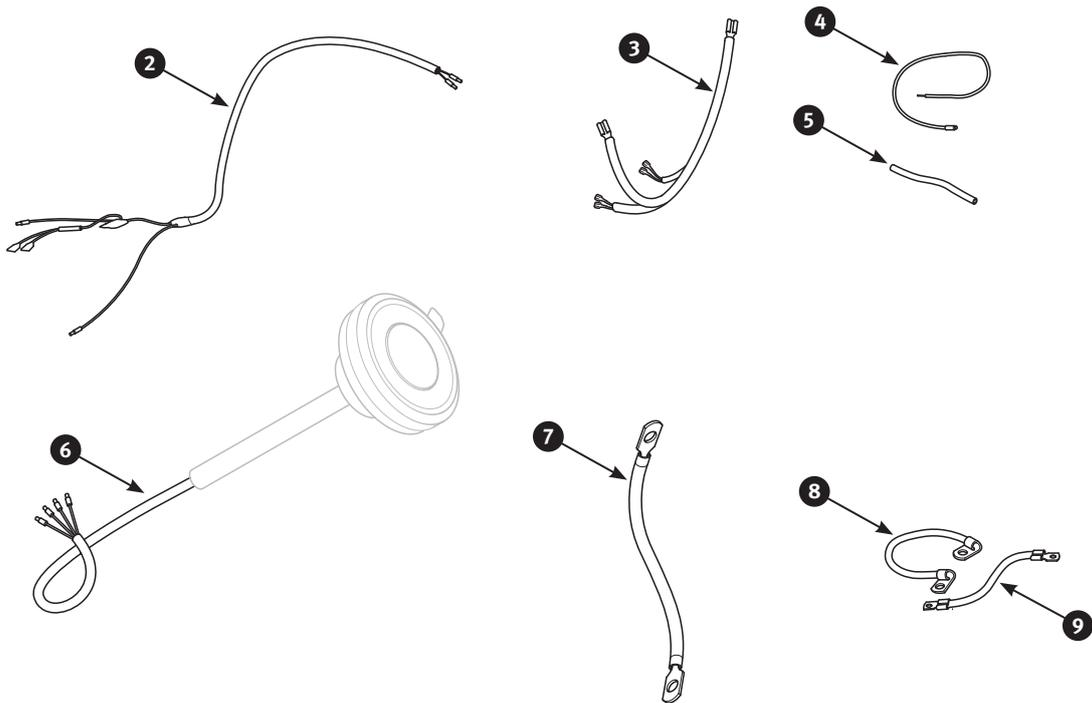
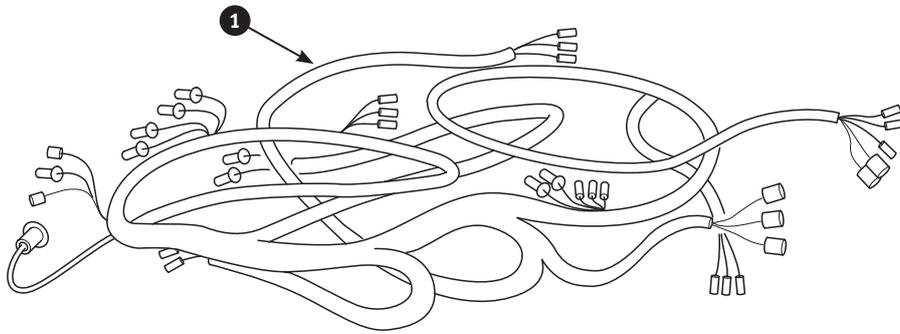

No	Part No	Description	Qty	Notes
1	20551	Wiring loom PVC cable and braided outer covering.	1	} TR2, TR3 to TS12568 - identify by non self parking wiper motor fitted on RH side of bulkhead and brake switch on LH side in engine bay
1	20552	Wiring loom PVC cable and PVC tape for outer covering	1	
1	20553	Wiring loom PVC cable and braided outer covering.	1	} TR3 from TS12569 to TS13045 - identify by self parking wiper motor fitted on LH side of bulkhead and brake switch on LH side in engine bay
1	20554	Wiring loom PVC cable and PVC tape for outer covering	1	
1	20555	Wiring loom PVC cable and braided outer covering.	1	} TR3 from TS13046 to TS18912 - identify by self parking wiper motor fitted on LH side of bulkhead and brake switch on RH side in engine bay
1	20556	Wiring loom PVC cable and PVC tape for outer covering	1	
1	20557	Wiring loom PVC cable and braided outer covering.	1	} TR3 from TS18913; TR3A to TS60000 - identify by separate rear indicator lamps
1	20558	Wiring loom PVC cable and PVC tape for outer covering	1	
1	20560	Wiring loom PVC cable and braided outer covering.	1	} TR3A from TS60001 - identify by lucar connectors on loom (instead of screwed terminals)
1	20559	Wiring loom PVC cable and PVC tape for outer covering	1	
1	21013	Wiring loom PVC cable and braided outer covering.	1	} TR4 RHD to CT14913
1	20561	Wiring loom PVC cable and PVC tape for outer covering	1	
1	21014	Wiring loom PVC cable and braided outer covering.	1	} TR4 RHD from CT14914
1	20562	Wiring loom PVC cable and PVC tape for outer covering	1	
1	216693	Wiring loom PVC cable and braided outer covering.	1	} TR4 LHD to CT9983
1	20563	Wiring loom PVC cable and PVC tape for outer covering	1	
1	21016	Wiring loom PVC cable and braided outer covering.	1	} TR4 LHD from CT9984 to CT26999
1	20564	Wiring loom PVC cable and PVC tape for outer covering	1	
1	21017	Wiring loom PVC cable and braided outer covering.	1	} TR4 LHD from CT27000
1	20565	Wiring loom PVC cable and PVC tape for outer covering	1	
1	21011	Wiring loom PVC cable and braided outer covering.	1	} TR4A RHD
1	20566	Wiring loom PVC cable and PVC tape for outer covering	1	
1	21012	Wiring loom PVC cable and braided outer covering.	1	} TR4A LHD
1	20567	Wiring loom PVC cable and PVC tape for outer covering	1	
2	201042	Harness overdrive switch to main wiring loom	1	} TR4 and TR4A fitted with overdrive
3	2388	Harness overdrive switch to relay	1	
4	300312	Cable brake light switch to main wiring loom.	1	} TR4 LHD from CT27000
4	20975	Cable side light to main loom - colour: red	0	
4	20976	Cable indicator to main loom - colour: green	0	} Quantity as required
4	20977	Cable lamp unit to chassis earth - colour: black	0	
4	21085	Cable horn to main loom	0	
5	20978	PVC sleeve for wires - inner diameter: 8 mm, length: 1 metre	0	
6	20477	Harness in steering column - for control head	1	} TR2, TR3, TR3A and TR3B
7	16161	Cable solenoid to starter motor	1	
8	11616	Earth cable engine to body.	1	} TR4 and TR4A
9	17942	Earth cable steering rack to chassis.	1	
9	1672	Earth cable flexible coupling on steering column	2	

Pliers
to connect bullet type terminals
Part no. 283873



14.8

Electrics

Instruments - TR2, TR3, TR3A and TR3B

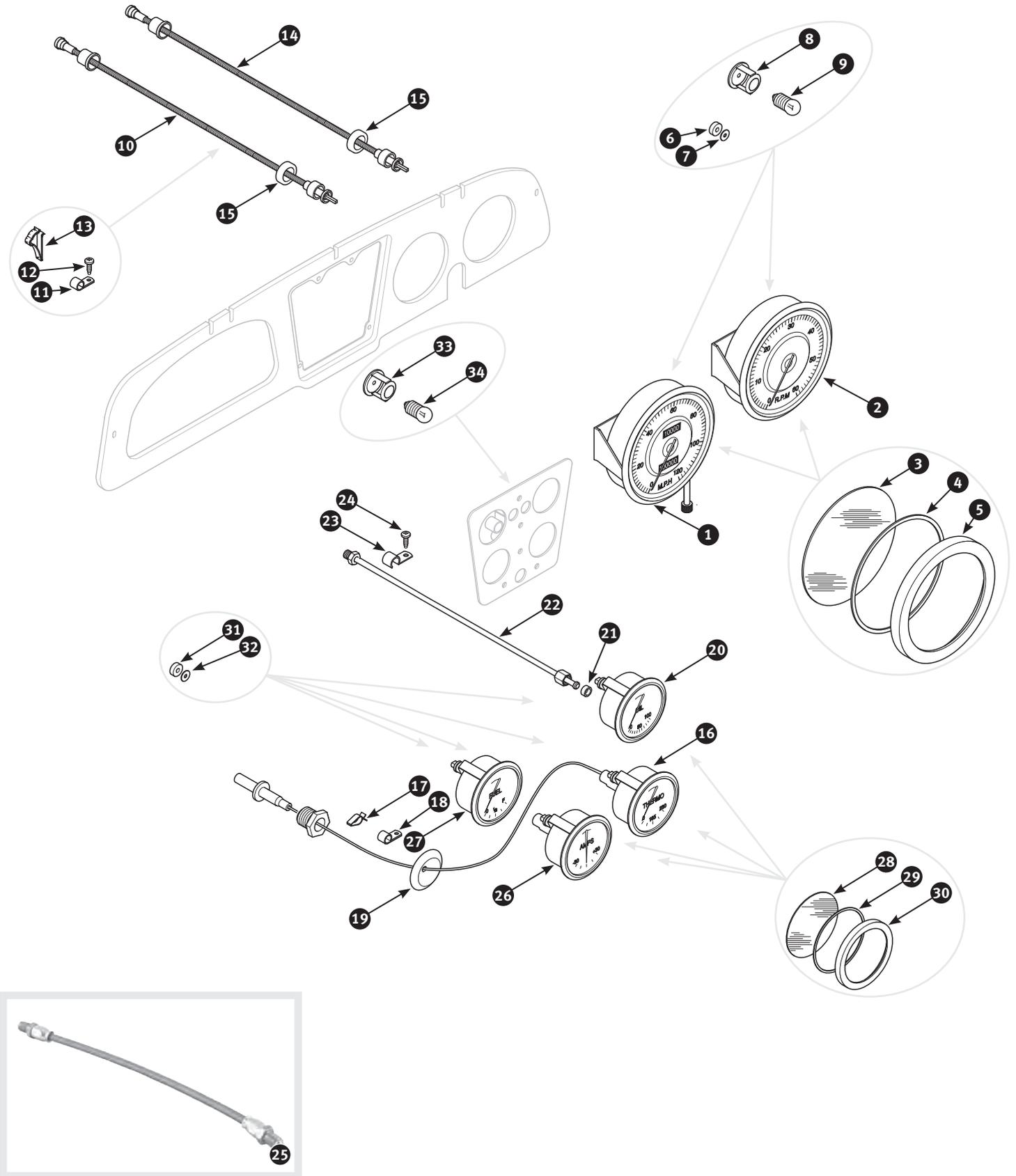

No	Part No	Description	Qty	Notes	
1	467664	Jaeger Speedometer exchange - serial no. S628	1	} Range in MP/H, final ratio 3.7:1	
1	11275	Jaeger Speedometer exchange - serial no. SN6307/04	1		
1	20699	Jaeger Speedometer exchange - serial no. SN6319/00	1		
1	298100	Jaeger Speedometer exchange - serial no. SN6307/11 or SN6319/06	1	} Range in MP/H, final ratio 3.7:1 cars with optional Michelin X tyres only	
1	21335	Jaeger Speedometer exchange - serial no. SN6307/08 or SN6319/02	1		
1	298102	Jaeger Speedometer exchange - serial no. SN6307/10 or SN6319/04	1	} Range in MP/H, final ratio 4.1:1 cars with optional Michelin X tyres only	
1	303145	Jaeger Speedometer exchange - serial no. S628K	1		
1	21270	Jaeger Speedometer exchange - serial no. SN6307/05	1	} Range in KP/H, final ratio 3.7:1	
1	11276	Jaeger Speedometer exchange - serial no. SN6319/01	1		
1	21336	Jaeger Speedometer exchange - serial no. SN6307/09 or SN6319/03	1		
2	316008	Jaeger Tachometer exchange - serial no. RC163	1	} Range in KP/H, final ratio 4.1:1	
2	11277	Jaeger Tachometer exchange - serial no. RN1402/09	1		
2	288919	Jaeger Tachometer exchange - serial no. RN1411/00	1		
3	20960	Instrument glass for speedometer and tachometer	2		
4	336327	,O' ring for speedometer and tachometer.	2		
5	298313	Chrome rim for speedometer and tachometer.	2		
6	21165	Knurled nut brass - for 5 mm stud	4		
6	8512	Knurled nut aluminium - for 4 mm stud.	4		
7	319079	Shakeproof washer	4		
8	16625	Bulb holder for speedometer and tachometer.	2		
9	2877	Bulb 2.2 watt, screw base	2		
10	2453	Cable speedometer - length: 84".	1	} all RHD models	
10	1058	Cable speedometer - length: 69".	1		} LHD non overdrive models
10	367	Cable speedometer - length: 96".	1		
11	11844	Retaining clip speedo cable to facia panel	1	} LHD overdrive models	
12	3821	Self tapping screw	1		
13	3423	Retaining clip speedo cable to chassis.	1	} RHD models	
14	2685	Cable tachometer - length: 55".	1		
14	368	Cable tachometer - length: 36".	1		} LHD models
15	22735	Grommet cables through bulkhead	2		
16	11272	Jaeger Temperature gauge exchange - serial no. X.80500/3 RT70 or TL2561/00.	1	} Range in F°	
16	11273	Jaeger Temperature gauge exchange - serial no. 51-312-561-03 or TL2561/03	1		} Range in C°
17	10947	Clip capillary tube to fuel pipe	2	} Range in lbs/square inch	
18	7745	Retaining clip capillary tube to facia stays	2		
19	22735	Grommet capillary tube through bulkhead	1		
20	19359	Jaeger Oil pressure gauge exchange - serial no. X.80516/2 OG103 or PL2561/00.	1		
20	11280	Jaeger Oil pressure gauge exchange - serial no. X.80516/3 OG103 or PL2561/01	1		} Range in Kg/qcm

14.8

Electrics

Instruments - TR2, TR3, TR3A and TR3B

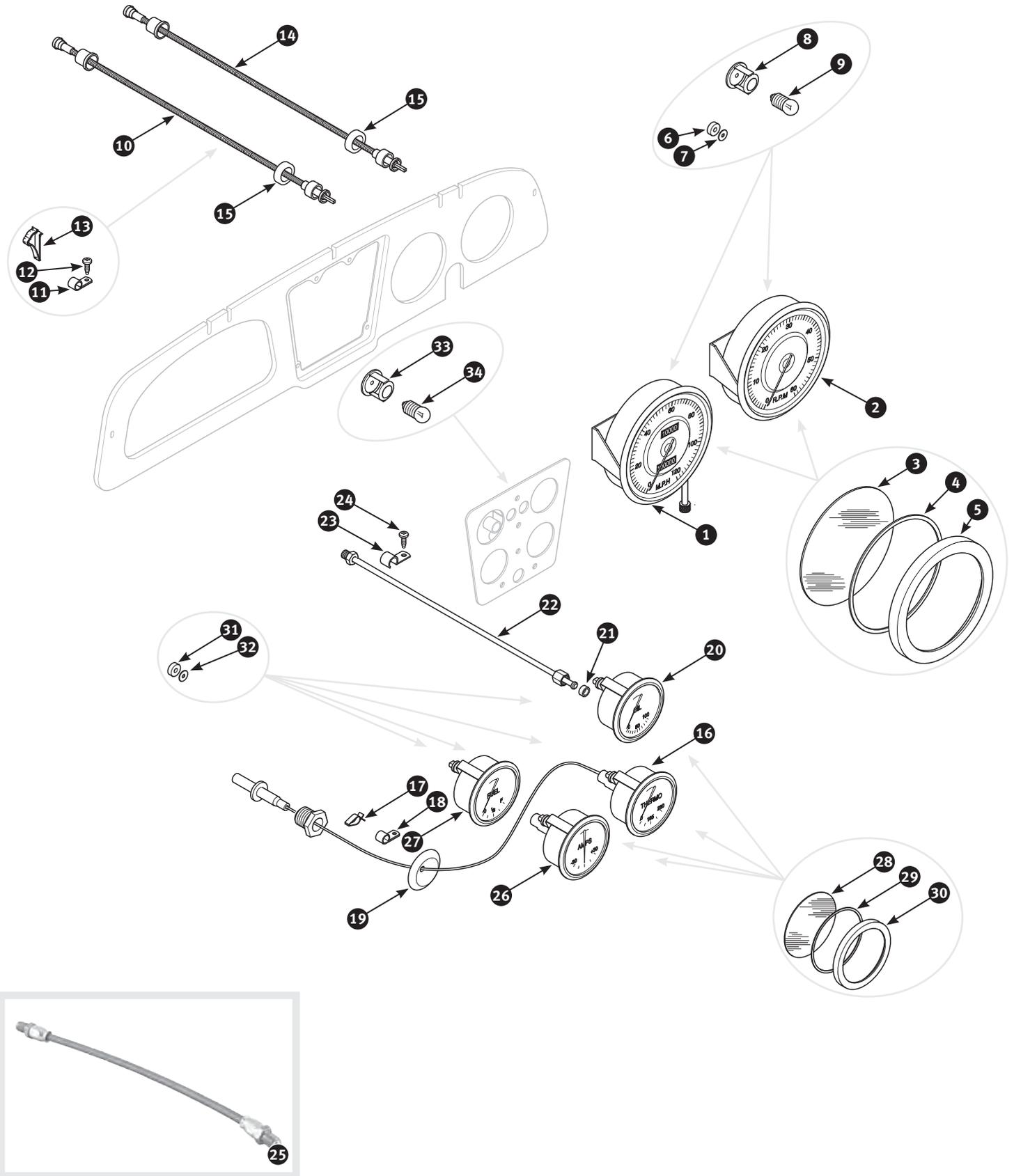

No	Part No	Description	Qty	Notes
21	5458	Leather washer	1	
22	21405	Oil pipe between gauge and oil hose	1	
23	3424	Retaining clip oil pipe to bulkhead	1	
24	20031	Self tapping screw	1	
25	2343	Oil hose between oil pipe and oil filter head	1	
26	11281	Lucas Ammeter exchange - serial no. 36174	1	} TR2 and TR3, TR3A to TS60000
26	11282	Lucas Ammeter exchange - serial no. 36264	1	
27	11278	Jaeger Fuel gauge exchange - serial no. X.49422/220 PG163 or FG2530/20.	1	
28	15244	Instrument glass for auxiliary instruments	4	
29	8517	,O' ring for auxiliary gauges	4	
30	311670	Chrome rim for auxiliary gauges	4	
31	8512	Knurled nut aluminium - for 4 mm stud	8	
32	319079	Shakeproof washer external teeth	8	
33	16625	Bulb holder on auxiliary instrument panel	2	
34	2877	Bulb 2.2 watt, screw base	2	

The smartest battery charger on the planet! Fully automatic high tech charger.

High frequency charger with multistage charging and peak control. Batteries can be charged while they are connected to the car without the danger of harming electric components. Pulse load keeps the battery always at 100% of its cranking capacity. Can be left connected permanently. The smartest charger we could find, fully automatic Swedish High-Tec charger.
Safety class IP65 (moisture protected and dust sealed).

C Tek Battery charger

Multi XS 3600 - for 12 volt batteries up to 120 AH, charging current: 0.8/3.6 A

Variant with Euro plug

Part no. 479841

Variant with UK plug

Part no. 373516



No	Part No	Description	Qty	Notes
1	4689	Light switch side and headlamp	1	
2	201303	Knob for side and headlamp switch	1	
3	6560	Push/pull switch windscreen wiper - single speed	1	
4	11066	Knob for windscreen wiper switch	1	
5	2447	Warning lamp ignition - red	1	
6	16246	Warning lamp indicator - amber	1	} All TR2 and TR3, early TR3A } Late TR3A, all TR3B
6	16248	Warning lamp indicator - green	1	
7	16626	Bulb holder for warning lamps	2	
8	2877	Bulb for warning lamps	2	
9	6560	Push/pull switch panel light	1	} All TR2 and TR3, early TR3A } Late TR3A, all TR3B
10	298312	Knob for panel light switch.	1	
11	17770	Rheostat panel light	1	} Late TR3A, all TR3B
12	11064	Knob for panel light rheostat	1	
13	11274	Switch Ignition	1	
14	1750	Locking barrel ignition switch - with two keys	1	} For private lock sets see chapter 18.8 } To identify the correct ignition lock key for your vehicle, add the three-digit combination to your key code to, i. e. FS876
15	329195	Key key code: FA.	1	
15	6339	Key key code: FS.	1	
15	299474	Key key code: FT.	1	
16	13863	Starter switch	1	
17	3971	Knob for starter switch.	1	
18	13867	Choke cable less knob	1	
19	3949	Knob choke cable	1	
20	26169	Grommet choke cable through bulkhead	1	
21	11844	Retaining clip choke cable to bulkhead	1	
22	17771	Heater rheostat with switch	1	
23	11296	Knob for heater rheostat - push-on type	1	} Alternatives
23	11295	Knob for heater rheostat - screw-on type.	1	
24	21007	Screw	1	
25	6560	Push/pull switch overdrive	1	} TR2 to TS6265 } can be used as an alternative on later cars
26	9573	Knob for overdrive switch.	1	
27	17773	Overdrive switch	1	} TR2 from TS6266, TR3, TR3A and TR3B
28	19245	Control head for fixed steering wheel	1	
28	20853	Control head for adjustable wheel.	1	
29	20477	Harness for control head	1	
30	4012	Knob set dashboard. Supplied in sets of 5.	1	} All TR2 and TR3, early TR3A } identify by push/pull switch for panel light } Late TR3A, all TR3B } identify by rheostat for panel light
30	4013	Knob set dashboard. Supplied in sets of 5.	1	



Hazard warning kit
12 V, for positive and negative earthed cars, complete with fitting instructions.
Part no. 287383

14.10

Electrics

Dashboard - TR2, TR3, TR3A and TR3B

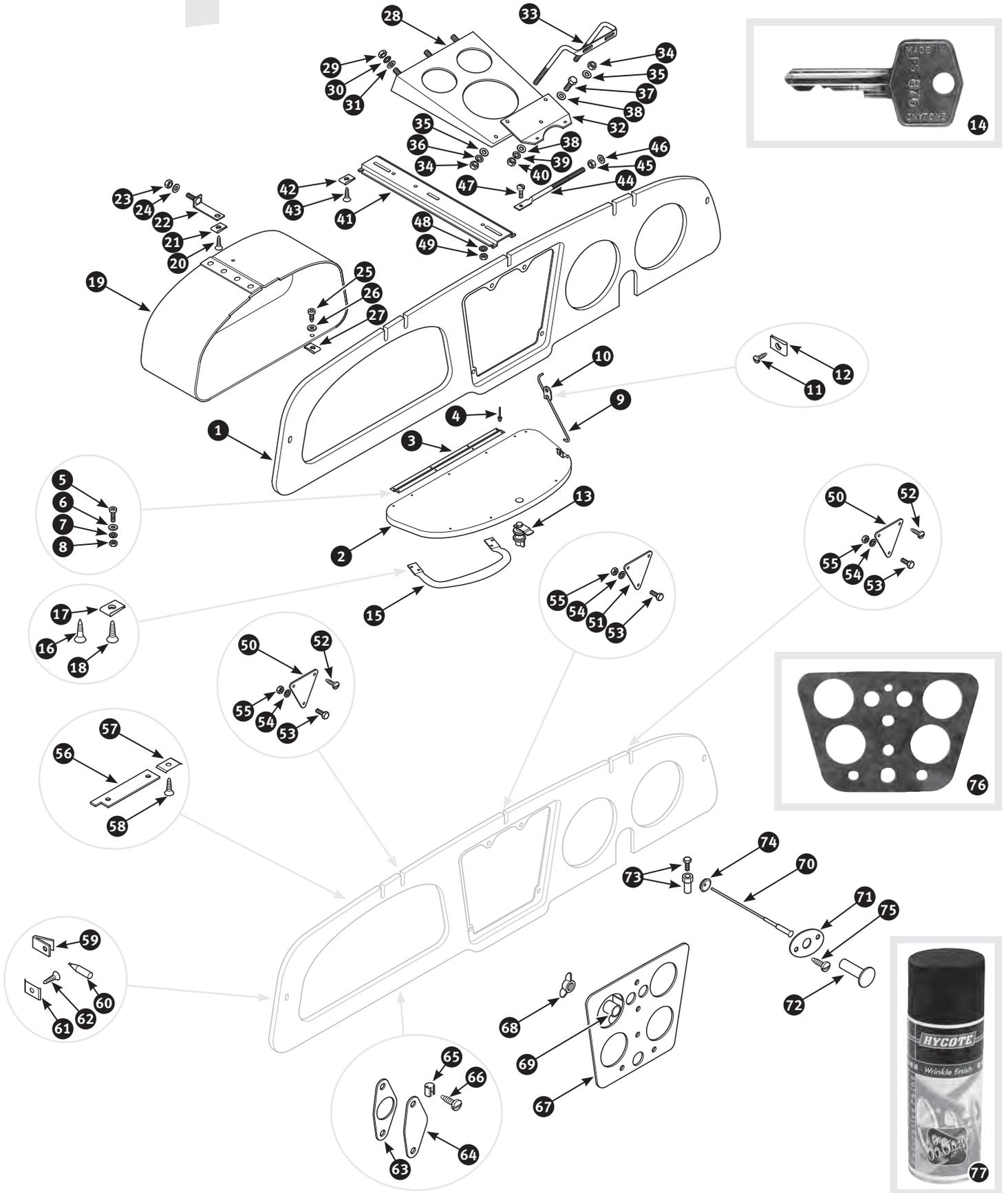

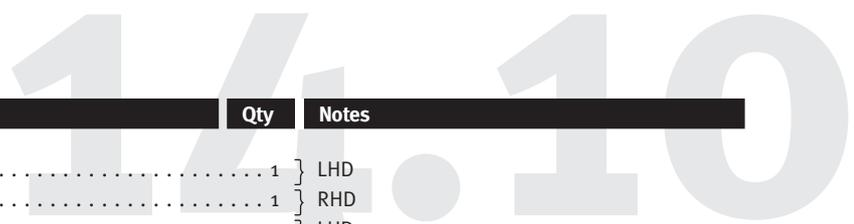

No	Part No	Description	Qty	Notes
1	300819	Dashboard panel	1	} LHD
1	300818	Dashboard panel	1	
2	300747	Lid glove box	1	} LHD
2	300746	Lid glove box	1	
3	300743	Hinge glove box lid	1	} RHD
4	10085	Pop rivet hinge to lid	4	
5	300713	Screw hinge to dashboard	4	
6	19383	Plain washer	4	
7	8136	Spring washer	4	
8	300876	Nut	4	
9	18050	Stay glove box lid	1	
10	21364	Bracket stay on glove box lid	1	} LHD
10	300742	Bracket stay on glove box lid	1	
11	4004	Self tapping screw bracket to dashboard	1	} RHD
12	7754	Spire nut	1	
13	411	Lock glove box	1	} With two keys assembly
14	329195	Key key code: FA.	1	
14	6339	Key key code: FS.	1	} To identify the correct glove box lock key for your vehicle, add the three-digit combination to your key code to, i. e. FS876
14	299474	Key key code: FT.	1	
15	19391	Grab handle on dashboard - chromed	1	
16	21106	Wood screw chromed - handle to dashboard	2	} TR2 and TR3, TR3A bis TS60000
17	5765	Countersunk screw chromed - handle to dashboard	2	
18	3081	Spire nut	2	} TR3A from TS60001, TR3B
19	19591	Glove box black.	1	
19	26319	Glove box red	1	} LHD
19	26320	Glove box blue	1	
19	330238	Glove box stone grey.	1	
19	330240	Glove box grey	1	
19	293797	Glove box beige	1	} RHD
19	12092	Glove box black.	1	
19	11438	Glove box red	1	
19	330235	Glove box blue	1	
19	204208	Glove box stone grey.	1	
20	219012	Self tapping screw glove box to bracket	1	
21	3824	Spire nut	3	
22	21366	Bracket glove box - rear support.	1	
23	215477	Nut bracket to body.	1	
24	212190	Spring washer	1	
25	3819	Self tapping screw glove box to dashboard - length: 1/2"	2	
25	219012	Self tapping screw glove box to dashboard - length: 3/4"	1	
26	212191	Plain washer	1	
27	3824	Spire nut	3	
28	203841	Anchor plate steering column	1	
29	2828	Nut anchor plate to body	3	
30	212192	Spring washer	3	
31	212191	Plain washer	3	
32	300794	Stiffener plate steering column	1	} LHD
32	300795	Stiffener plate steering column	1	
33	296192	Retaining bar steering column - new item	1	} RHD
33	25930	Retaining bar steering column - used item.	1	
34	2303	Nut	4	
35	10487	Plain washer	4	
36	212194	Spring washer	2	
37	7894	Screw stiffener plate to anchor plate.	5	
38	10487	Plain washer	2	
39	212194	Spring washer	1	
40	2303	Nut	1	

14.10

Electrics

Dashboard - TR2, TR3, TR3A and TR3B

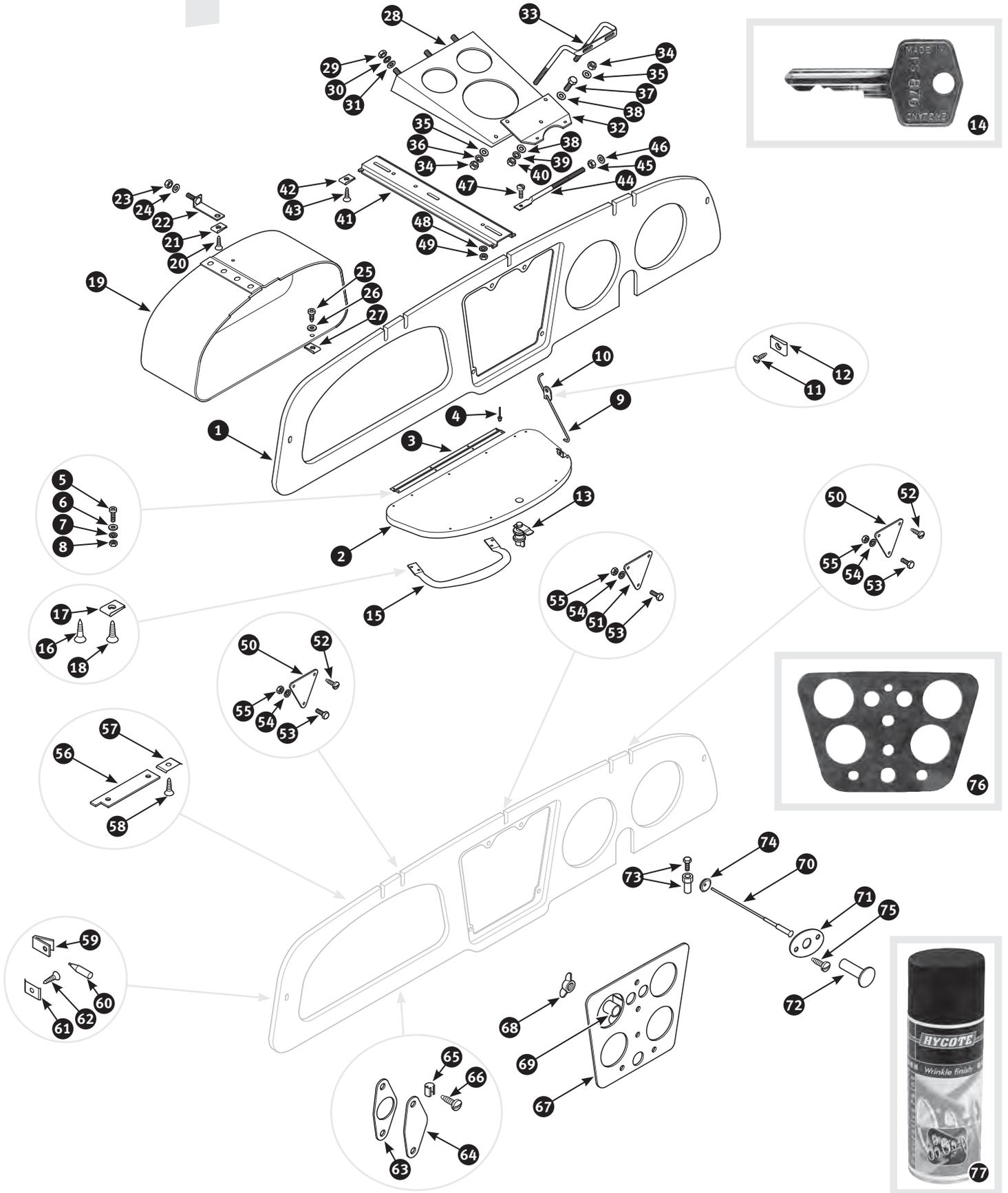

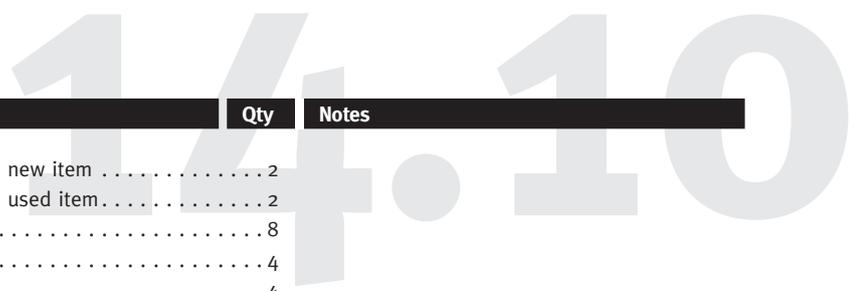

No	Part No	Description	Qty	Notes
41	2815	Steady rod dashboard to battery box - new item	2	
41	200768	Steady rod dashboard to battery box - used item	2	
42	9658	Spire nut	8	
43	3821	Self tapping screw - length: 1/2"	4	
43	3822	Self tapping screw - length: 3/4"	4	
44	300750	Connecting rod steering column to steady rod	1	
45	2303	Nut	2	
46	212193	Plain washer	2	
47	3120	Pointed screw connecting rod to steady rod	1	
48	212192	Spring washer	1	
49	2303	Nut	1	
50	300741	Bracket dashboard outer fixing	2	
51	300745	Bracket dashboard centre fixing	1	
52	11320	Countersunk screw outer bracket to scuttle rim	4	
53	3120	Pointed screw dashboard to scuttle rim	5	
54	212192	Spring washer	7	
55	2828	Nut	7	
56	21365	Lock striker glove box	1	
57	7754	Spire nut	2	
58	4004	Self tapping screw lock stricker to dashboard	2	
59	21363	Bracket rubber buffer	1	
60	21375	Rubber buffer glove box lid	2	
61	7754	Spire nut	2	
62	4004	Self tapping screw bracket to dashboard	2	
63	289160	Seal closing steering column aperture in bulkhead	1	
64	289158	Blanking plate steering column aperture in bulkhead	1	} LHD } RHD
64	300740	Blanking plate steering column aperture in bulkhead	1	
65	3081	Spire nut	2	
66	24889	Countersunk screw blanking plate to bulkhead	2	
67	21430	Instrument panel - new item	1	
67	203839	Instrument panel - used item	1	
68	10482	Wing nut instrument panel to dashboard	4	
69	298151	Support bracket panel light - LH side	1	
69	300744	Support bracket panel light - RH side	1	
70	11533	Operating rod air vent	1	} TR2 from TS6157, TR3, TR3A and TR3B
71	1826	Escutcheon air vent knob - epigram: ,vent pull'	1	
72	3966	Knob air vent rod	1	
73	19467	Trunnion air vent rod	1	
74	26169	Grommet	1	
75	11320	Countersunk screw escutcheon to dashboard	2	} For further information see chapter 21.24
76	312715	Wood dashboard Walnut - instrument panel only	1	
76	312714	Wood dashboard Elm - instrument panel only	1	
77	20798	Wrinkle paint black, 400 ml aerosol	1	

14.11

Electrics

Instruments - TR4 und TR4A

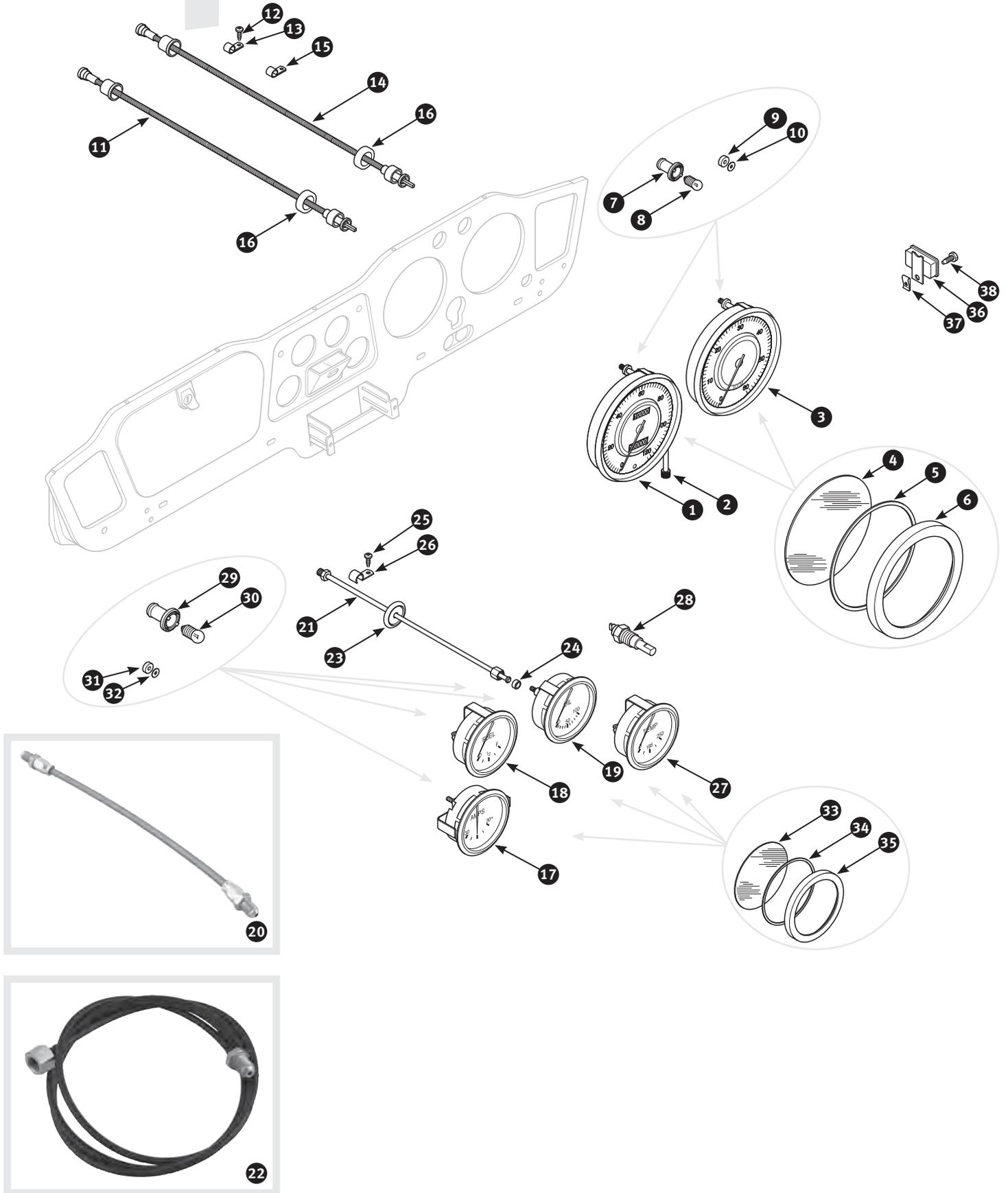

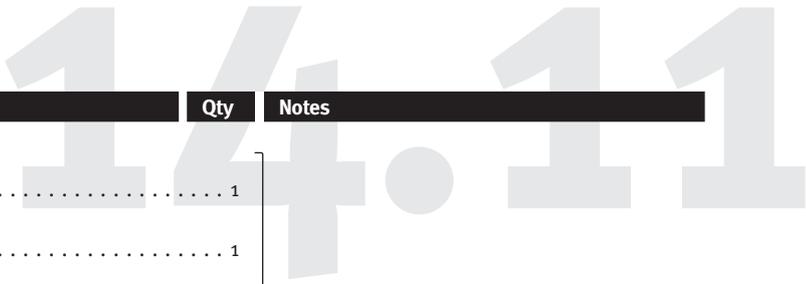

No	Part No	Description	Qty	Notes	
1	19201	Jaeger Speedometer exchange - serial no. SN6313/09, range in MP/H	1	} TR4 RHD to CT15053, TR4 LHD to CT11307	
1	19202	Jaeger Speedometer exchange - serial no. SN6313/10, range in KM/H	1		
1	21406	Jaeger Speedometer exchange - serial no. SN6313/11, range in MP/H.	1		
1	21407	Jaeger Speedometer exchange - serial no. SN6313/11, range in KM/H.	1		
1	19204	Jaeger Speedometer exchange - serial no. SN6313/19, range in MP/H	1		
1	19205	Jaeger Speedometer exchange - serial no. SN6313/20, range in KM/H	1		
1	21410	Jaeger Speedometer exchange - serial no. SN6313/17, range in MP/H	1		
1	21411	Jaeger Speedometer exchange - serial no. SN6313/18, range in KM/H	1		
1	21412	Jaeger Speedometer exchange - serial no. SN6325/00, range in MP/H	1		
1	21413	Jaeger Speedometer exchange - serial no. SN6325/01, range in KM/H	1		
1	21414	Jaeger Speedometer exchange - serial no. SN6325/06, range in MP/H	1		
1	21415	Jaeger Speedometer exchange - serial no. SN6325/05; range in KM/H.	1		
1	19206	Jaeger Speedometer exchange - serial no. SN6325/02, range in MP/H	1		} TR4 RHD from CT15054, TR4 LHD from CT11308, all TR4A
1	19207	Jaeger Speedometer exchange - serial no. SN6325/03, range in KM/H.	1		
1	21416	Jaeger Speedometer exchange - serial no. SN6325/08, range in MP/H	1		
1	21417	Jaeger Speedometer exchange - serial no. unknown, range in KM/H	1		
2	21101	Reset knob speedometer trip	1	} TR4 RHD to CT15053, TR4 LHD to CT11307	
3	19203	Jaeger Tachometer exchange - serial no. RN1409/02	1		
3	15785	Jaeger Tachometer exchange - serial no. RN1417/00.	1		
4	20960	Instrument glass domed - for speedometer and tachometer.	2	} TR4 RHD to CT15053, TR4 LHD to CT11307	
4	21082	Instrument glass flat - for speedometer and tachometer	2		} TR4 RHD from CT15054, TR4 LHD from CT11308, all TR4A
5	336327	,O' ring for speedometer and tachometer.	2		
6	298313	Chrome rim for speedometer and tachometer.	2		
7	287264	Bulb holder - speedometer and tachometer illumination	2		
8	2877	Bulb - speedometer and tachometer illumination	2		
9	8512	Knurled nut - retaining speedometer and tachometer	4		
10	319079	Shakeproof washer	4		
11	1058	Cable speedometer - length: 69".	1	} All overdrive models	
11	2452	Cable speedometer - length: 78".	1		} RHD non overdrive models
11	1058	Cable speedometer - length: 69".	1		
12	11844	Retaining clip speedo cable	1		
13	3821	Self tapping screw	1		
14	205197	Cable tachometer - length: 47".	1	} RHD models	
14	368	Cable tachometer - length: 36".	1		} LHD models
15	313692	Retaining clip tachometer cable to battery carrier hook.	1		
16	22735	Grommet cables through bulkhead	2		
17	11282	Lucas Ammeter exchange - serial no. 36264.	1	} TR4 RHD to CT15053, TR4 LHD to CT11307	
17	21397	Lucas Ammeter exchange - serial no. 26313	1		} TR4 RHD from CT15054, TR4 LHD from CT11308, all TR4A
18	21394	Jaeger Fuel gauge exchange - serial no. BF2301/00	1	} TR4 RHD to CT15053, TR4 LHD to CT11307	
18	21398	Jaeger Fuel gauge exchange - serial no. BF2206/00.	1		} TR4 RHD from CT15054, TR4 LHD from CT11308, all TR4A

14.11

Electrics

Instruments - TR4 und TR4A

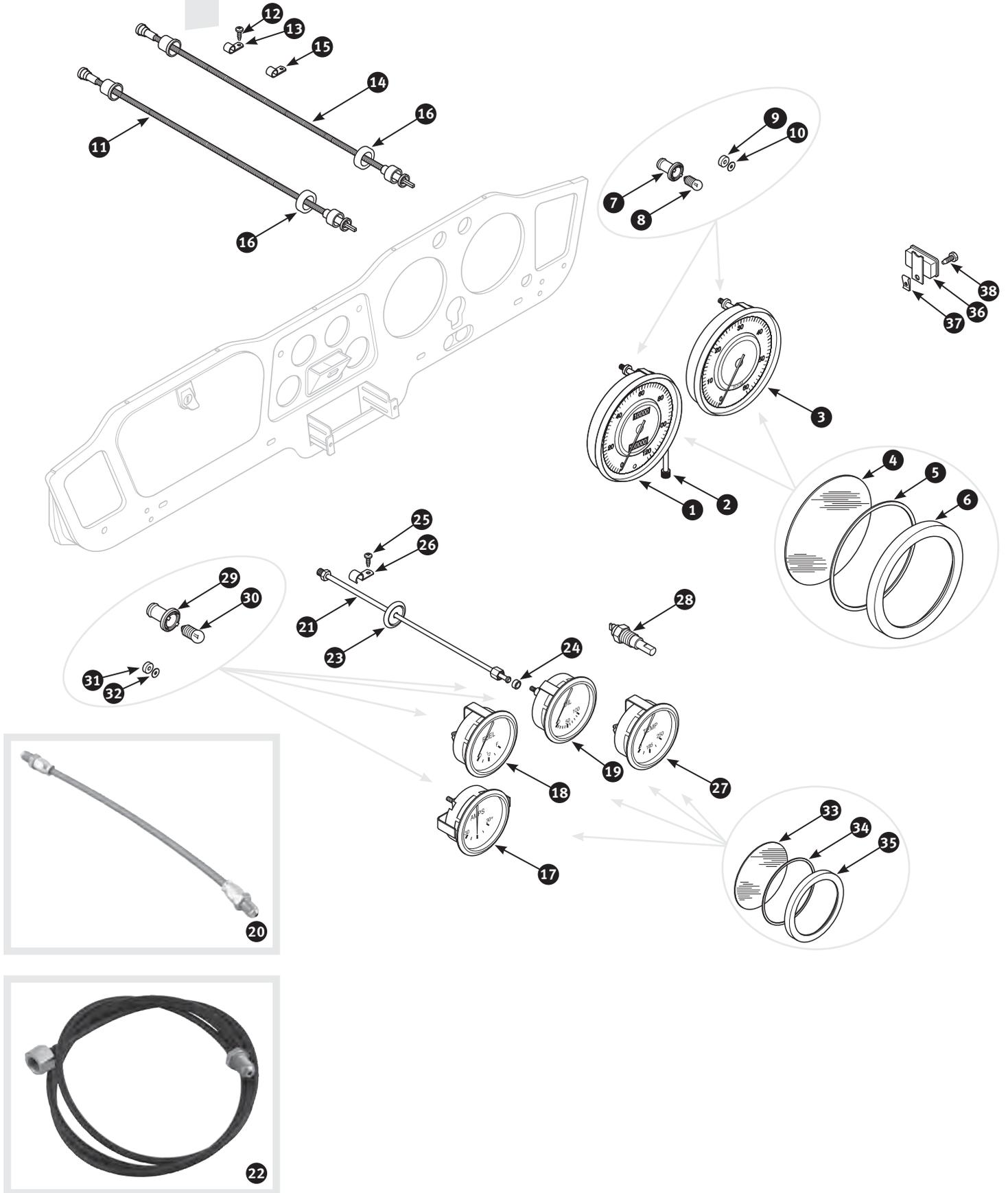

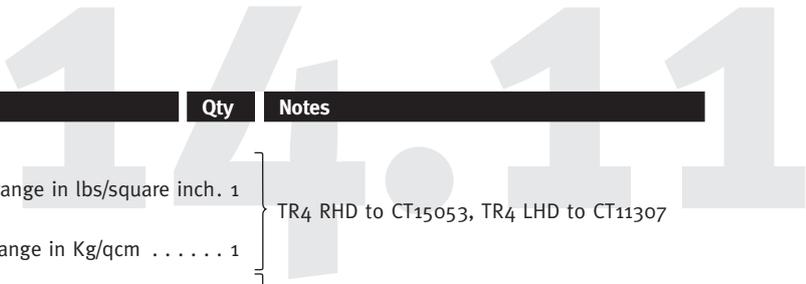

No	Part No	Description	Qty	Notes
19	19359	Jaeger Oil pressure gauge exchange - serial no. X.80516/2 OG103 or PL2561/00, range in lbs/square inch	1	} TR4 RHD to CT15053, TR4 LHD to CT11307
19	11280	Jaeger Oil pressure gauge exchange - serial no. X.80516/3 OG103 or PL2561/01, range in Kg/qcm	1	
19	21399	Jaeger Oil pressure gauge exchange: serial no. PL2302/22 - range in lbs/square inch	1	
19	21391	Jaeger Oil pressure gauge exchange: serial no. PL2302/23 - range in Kg/qcm	1	} TR4 RHD from CT15054, TR4 LHD from CT11308, all TR4A
20	2343	Oil hose between oil pipe and oil filter head	1	
21	21405	Oil pipe between gauge and oil hose	1	} TR4
22	9699	Oil feed pipe between oil gauge and oil filter head - nylon	1	
22	9699	Oil feed pipe between oil gauge and oil filter head - nylon	1	} TR4A - may replace original oil pipe and hose on TR4 models
23	22735	Grommet oil pipe through bulkhead	1	
24	5458	Leather washer	1	
25	20031	Self tapping screw	2	
26	3424	Retaining clip oil pipe to bulkhead	2	
27	21395	Jaeger Temperature gauge exchange - serial no. BT2300/00, range: 110-250 F°.	1	} TR4 RHD to CT15053, TR4 LHD to CT11307
27	21396	Jaeger Temperature gauge exchange - serial no. BT2300/01, range: 30-100 C°.	1	
27	21400	Jaeger Temperature gauge exchange - serial no. BT2203/00, range: 110-250 F°.	1	} TR4 RHD from CT15054, TR4 LHD from CT11308, TR4A to CTC62636
27	20684	Jaeger Temperature gauge exchange - serial no. BT2203/01, range: 30-100 C°.	1	
27	21403	Jaeger Temperature gauge exchange - serial no. BT2203/03, range: C-N-H	1	} TR4A from CTC62637
28	2216	Thermal transmitter for temperature gauge	1	
29	287264	Bulb holder - auxiliary gauges illumination.	4	
30	2877	Bulb - auxiliary gauges illumination.	4	
31	8512	Knurled nut - retaining auxiliary gauges.	8	
32	319079	Shakeproof washer	8	
33	15244	Instrument glass domed - for auxiliary gauges	4	} TR4 RHD to CT15053, TR4 LHD to CT11307
33	21083	Instrument glass flat - for auxiliary gauges.	4	
33	21083	Instrument glass flat - for auxiliary gauges.	4	} TR4 RHD from CT15054, TR4 LHD from CT11308, all TR4A
34	8517	,O' ring for auxiliary gauges	4	
35	311670	Chrome rim for auxiliary gauges	4	
36	3014	Voltage stabilizer for fuel and temperature gauge.	1	
37	3824	Spire nut	1	
38	3819	Self tapping screw voltage stabiliser to bulkhead.	1	



Hazard warning kit
 12 V, for positive and negative earthed cars, complete with fitting instructions.
 Part no. 287383

14.12

Electrics

Switches and steering lock - TR4 and TR4A

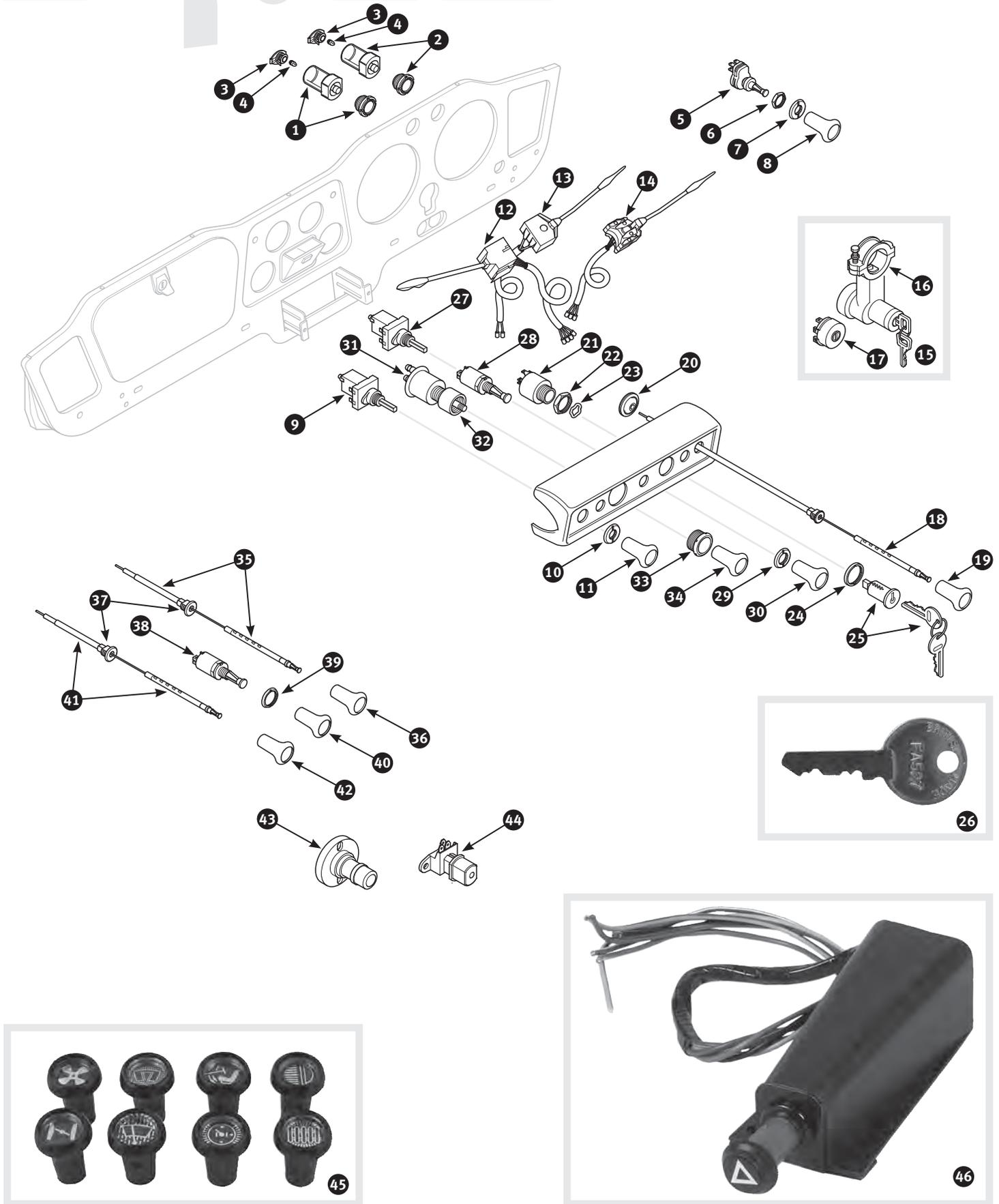

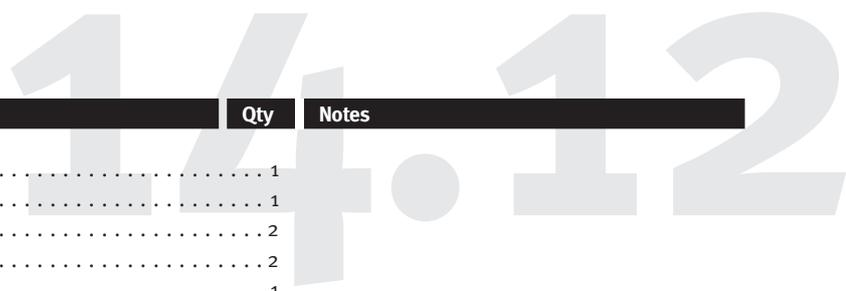

No	Part No	Description	Qty	Notes
1	2447	Warning lamp ignition - red	1	
2	16248	Warning lamp indicator - green	1	
3	16626	Bulb holder for warning lamps	2	
4	2877	Bulb for warning lamps	2	
5	17770	Rheostat panel light	1	
6	9617	Nut rheostat	1	
7	2221	Chrome bezel rheostat	1	
8	16908	Knob panel light rheostat	1	
9	200657	Push/pull switch side and headlamps	1	} TR4
10	2221	Chrome bezel light switch	1	
11	16909	Knob light switch	1	} TR4A LHD
12	26150	Stalk side and headlamps	1	
12	9728	Stalk side and headlamps	1	} TR4A RHD
13	4330	Stalk indicator	1	
14	298261	Stalk overdrive, chrome	1	} TR4- may replace by TR4A overdrive switch
14	201076	Stalk overdrive, black	1	} TR4A LHD
14	4761	Stalk overdrive, black	1	
15	11354	Ignition switch and lock	1	} TR4A RHD
16	209868	Shear bolt - separately	2	
17	5443	Ignition switch - separately	1	} Germany exports only
18	19656	Choke cable	1	
19	16910	Knob choke cable	1	
20	26169	Grommet choke cable through bulkhead	1	
21	2383	Switch ignition	1	} All countries less Germany
22	11405	Nut ignition switch	1	
23	295804	Washer ignition switch	1	
24	293462	Chrome bezel ignition switch	1	} All countries less Germany
25	1750	Locking barrel ignition switch - with two keys	1	
26	329195	Key key code: FA	1	} To identify the correct ignition lock key for your vehicle, add the three-digit combination to your key code to, i. e. FS876
26	6339	Key key code: FS	1	
26	299474	Key key code: FT	1	
27	6560	Push/pull switch windscreen wiper - single speed	1	} TR4
28	200657	Push/pull switch windscreen wiper - two speed	1	
29	18033	Chrome bezel for single speed wiper switch	1	} Optional for TR4, all TR4A
29	2221	Chrome bezel for two speed wiper switch	1	
30	10465	Knob windscreen wiper switch	1	
31	2130	Washer pump without knob	1	
32	293461	Spacer washer pump	1	
33	293464	Chrome bezel washer pump	1	
34	10448	Knob washer pump	1	
35	481430	Control cable heater	1	
36	10800	Knob heater cable	1	
37	300733	Nut chrome - heater and air distribution cable	2	
38	6560	Push/pull switch heater fan	1	
39	18033	Chrome bezel heater fan switch	1	
40	16907	Knob heater fan switch	1	
41	10498	Control cable air distribution	1	
42	16906	Knob air distribution cable	1	
43	9539	Foot dipper switch headlamps - round type: 21SA	1	} For further information see chapter 14.6
44	200671	Foot dipper switch headlamp - square type: 103SA	1	
45	11301	Knob set dashboard. Supplied in sets of 8	1	
46	287383	Hazard warning kit	1	

14.13

Electrics

Dashboard - TR4

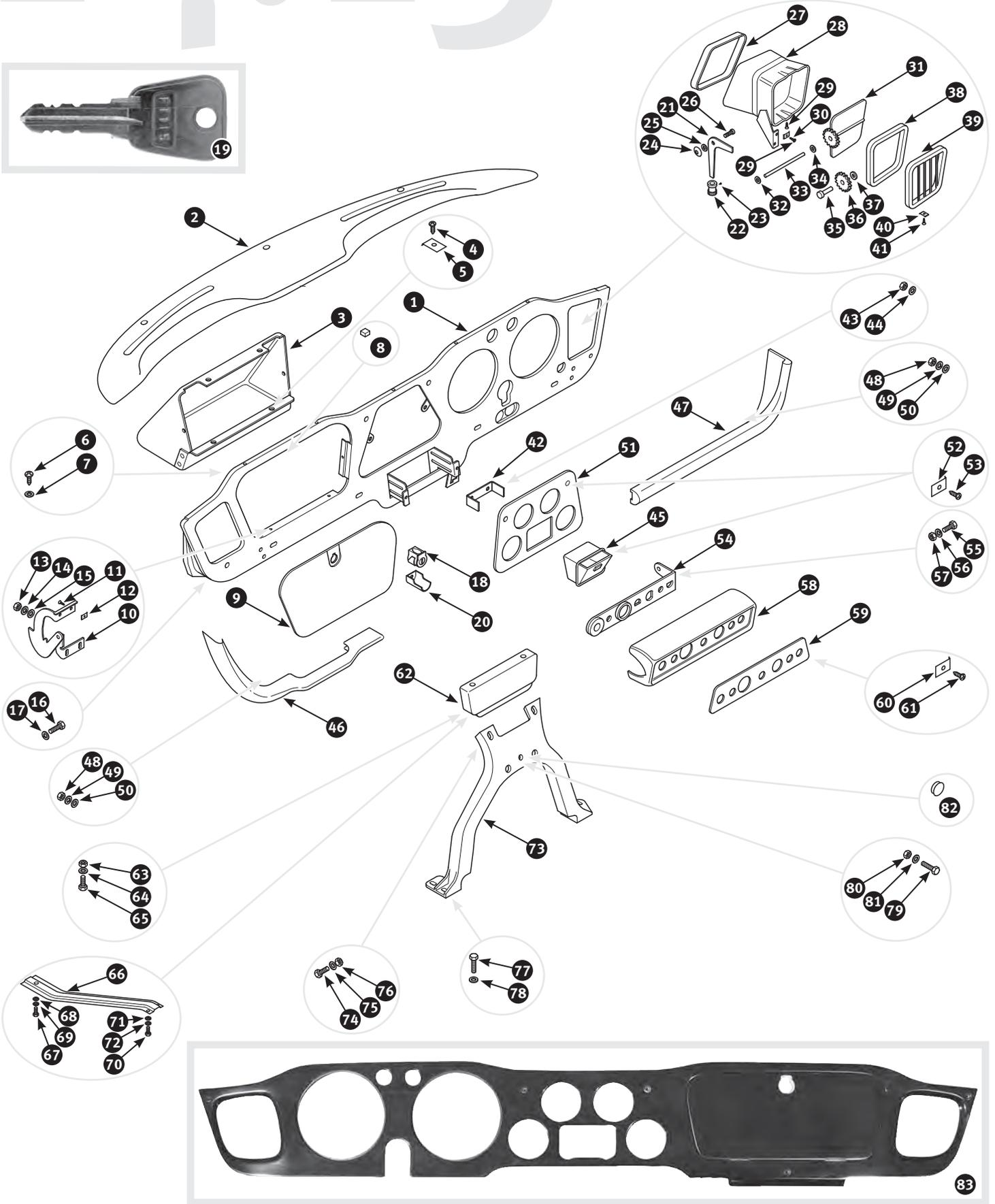

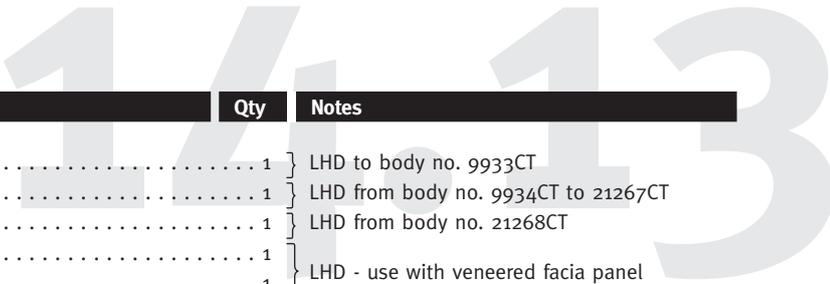

No	Part No	Description	Qty	Notes
1	1220	Dashboard panel	1	} LHD to body no. 9933CT
1	295442	Dashboard panel - ,spa white'	1	
1	295131	Dashboard panel - ,new white'	1	} LHD from body no. 9934CT to 21267CT
1	455820	Dashboard panel - ,spa white'	1	
1	462448	Dashboard panel - ,new white'	1	} LHD - use with veneered facia panel
1	295538	Dashboard panel	1	
1	295539	Dashboard panel - ,spa white'	1	} RHD to body no. 15053CT
1	342073	Dashboard panel - ,new white'	1	
1	342074	Dashboard panel - ,spa white'	1	} RHD from body no. 15054CT to 21267CT
1	296231	Dashboard panel - ,new white'	1	
1	296231	Dashboard panel - ,new white'	1	} RHD from body no. 21268CT
2	187	Top cover dashboard	1	
3	13746	Glove box cardboard	1	} Alternatives
3	25226	Glove box plastic	1	
4	4163	Self tapping screw glove box to dashboard	6	
5	19416	Spire nut	6	
6	7853	Panhead screw dashboard to scuttle rail	5	} Not required when veneered dashboard is fitted
7	212192	Spring washer	5	
8	9638	Rubber buffer glove box lid	1	
9	214789	Lid glove box, metal - ,spa white'	1	
9	300735	Lid glove box, metal - ,new white'	1	
10	26268	Hinge glove box lid, LH	1	
10	26267	Hinge glove box lid, RH	1	
11	5756	Self tapping screw hinge to glove box lid	4	
12	19416	Spire nut	4	
13	215477	Nut hinge to dashboard	2	
14	212190	Spring washer	2	
15	7793	Plain washer	2	
16	3120	Pointed screw dashboard to ,A' post	2	
17	212192	Spring washer	2	
18	16996	Lock glove box	1	
19	329195	Key key code: FA	1	
19	6339	Key key code: FS	1	} To identify the correct glove box lock key for your vehicle, add the three-digit combination to your key code to, i. e. FS876
19	299474	Key key code: FT	1	
20	1679	Handle glove box lid - chromed	1	
21	300738	Lever air vent	1	
22	20786	Knob air vent lever	1	
23	5695	Self tapping screw knob to lever	1	
24	300827	Retainer	1	
25	6306	Double coil washer	1	
26	300833	Rivet	1	
27	300760	Seal fresh air duct to plenum chamber	2	
28	300796	Fresh air duct LH	1	
28	300797	Fresh air duct RH	1	
29	4163	Self tapping screw fresh air duct to dashboard	6	
30	3088	Spire nut	4	
31	300755	Air flap LH fresh air duct	1	
31	300756	Air flap RH fresh air duct	1	
32	10689	Retaining clip	2	
33	300757	Spindle air flap	2	
34	7794	Plain washer	2	
35	300759	Pivot pin air flap adjuster	2	
36	300758	Adjuster air flap	2	
37	300830	Spire nut	2	
38	300465	Seal fresh air duct to dashboard	2	
39	469762	Grille LH fresh air duct	1	
39	296271	Grille RH fresh air duct	1	

14.13

Electrics

Dashboard - TR4

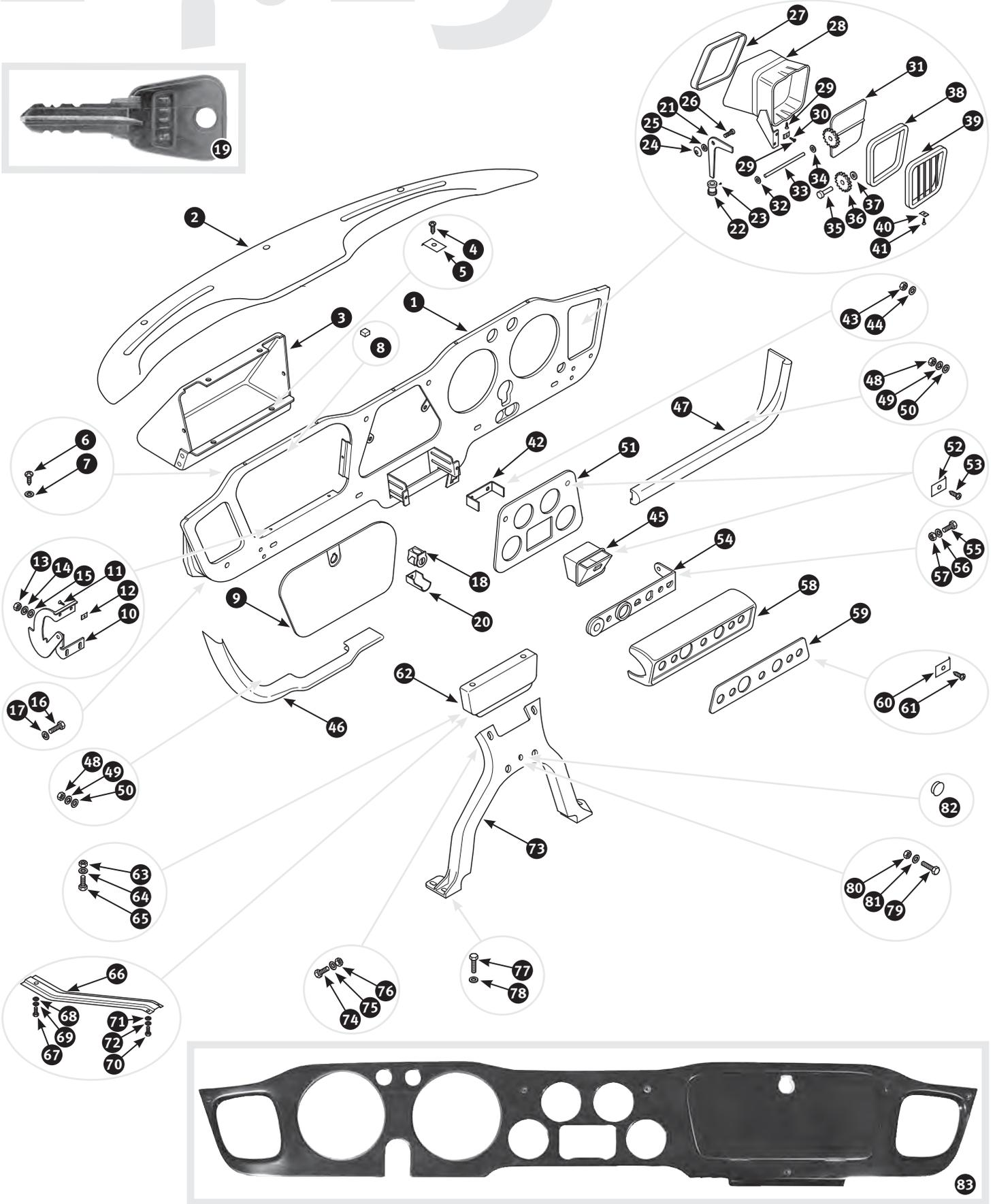

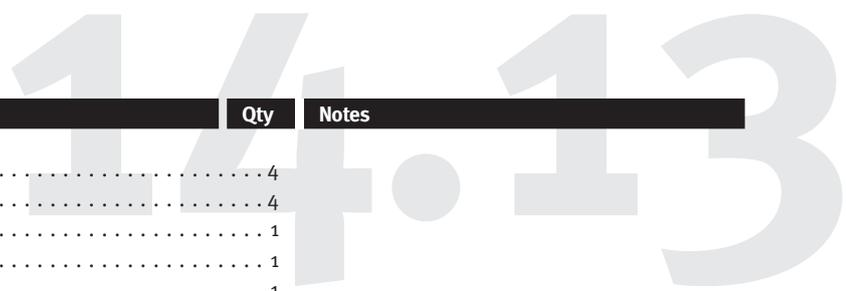

No	Part No	Description	Qty	Notes	
40	19416	Spire nut	4		
41	4163	Self tapping screw grille to dashboard.	4		
42	300774	Bracket ashtray	1		
43	215477	Nut ashtray to bracket	1		
44	212190	Spring washer	1		
45	10270	Ashtray	1		
46	2546	Crash pad below dashboard, LH - no grab handle.	1	} LHD	
47	11484	Crash pad below dashboard, RH - with grab handle	1		
46	296894	Crash pad below dashboard, LH - with grab handle	1	} RHD	
47	10994	Crash pad below dashboard, RH - no grab handle	1		
48	215477	Nut crash pad to dashboard.	6		
49	212190	Spring washer	6		
50	7793	Plain washer	6		
51	214246	Instrument panel metal	1	} To body no.4398CT	
51	214247	Instrument panel metal	1		} From body no. 4399CT
52	11806	Spire nut	2		
53	3819	Self tapping screw instrument panel to dashbord.	2		
54	300736	Reinforcement switch mounting	1	} To body no. 25934CT	
54	200424	Reinforcement switch mounting	1		} From body no. 25935CT
55	7884	Screw reinforcement to dashboard	1		
56	212192	Spring washer	1		
57	2828	Nut	1		
58	294041	Switch plinth	1	} To body no. 25934CT may replace by switch plinth 288894 and switch plate 200425	
59	16001	Switch plate	1		
58	288894	Switch plinth	1	} From body no. 25935CT	
59	200425	Switch plate	1		
60	3268	Self tapping screw switch plate and plinth to reinforcement	2		
61	3824	Spire nut	2		
62	300772	Bracket centre console to dashboard.	1	} All countries less USA	
62	300773	Bracket centre console to dashboard.	1		} USA exports to body no. 8379CT
62	300776	Bracket centre console to dashboard.	1		
63	7455	Nyloc nut	2		
64	212193	Plain washer	2		
65	213886	Screw bracket to dashboard.	2		
66	462467	Bracket dashboard to bulkhead - new item	1		
66	200520	Bracket dashboard to bulkhead - used item.	1		
67	7885	Screw bracket to bulkhead.	1		
68	212191	Plain washer	1		
69	212192	Spring washer	1		
70	214337	Panhead screw bracket to dashboard	2		
71	7793	Plain washer	2		
72	212190	Spring washer	2		
73	202517	Centre console	1	} To body no. 1527CT	
73	215128	Centre console	1		} From body no. 1528CT
74	10376	Screw centre console to bracket - chromed	2		
75	10387	Plain washer chromed	2		
76	2049	Nyloc nut	2		
77	3072	Screw centre console to floor panel.	4		
78	212191	Plain washer	4		
79	10376	Screw to blank heater switch hole - chromed	1	} Cars without heater unit	
80	2303	Nut	1		
81	212194	Spring washer	1		
82	7809	Blanking plug to blank heater cable holes	2		
83	205414	Wood dashboard walnut - LHD models	1	} For further information see chapter 21.24	
83	21257	Wood dashboard elm - LHD models	1		
83	307128	Wood dashboard walnut - RHD models	1		
83	343003	Wood dashboard elm - RHD models	1		

14.14

Electrics

Dashboard - TR4A

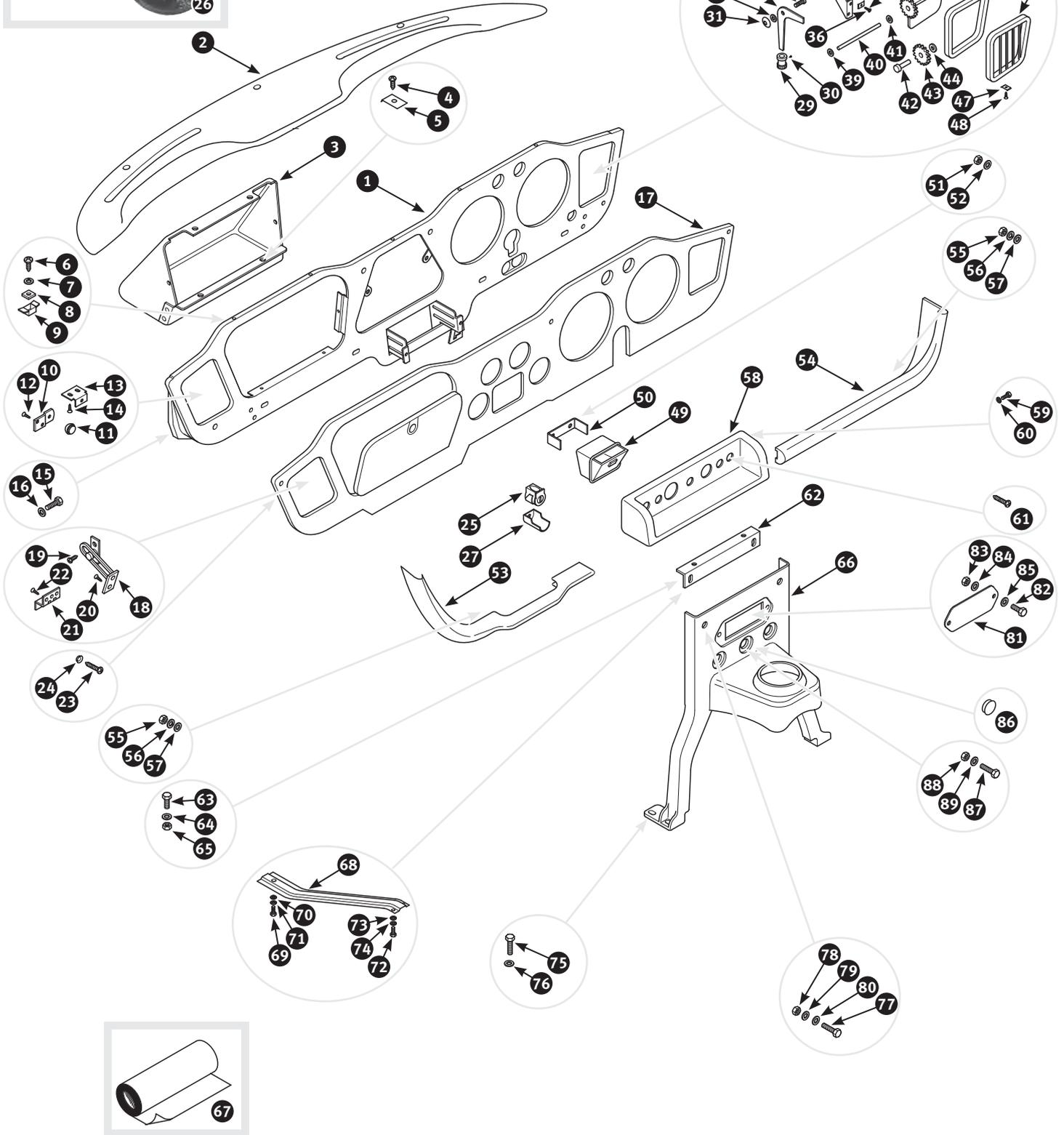

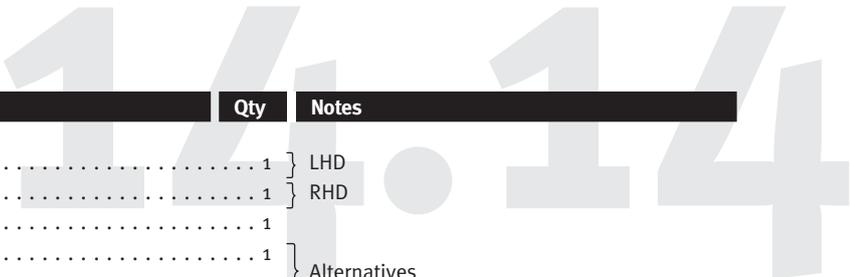

No	Part No	Description	Qty	Notes
1	300821	Dashboard panel	1	} LHD
1	20281	Dashboard panel	1	
2	187	Top cover dashboard	1	} Alternatives
3	13746	Glove box cardboard	1	
3	25226	Glove box plastic	1	
4	4163	Self tapping screw glove box to dashboard	6	
5	19416	Spire nut	6	
6	7853	Panhead screw dashboard to scuttle rail	5	
7	212192	Spring washer	5	
8	10629	Square nut	5	
9	10630	Cage for square nut	5	
10	26265	Bracket glove box lid buffer	1	
11	9638	Rubber buffer glove box lid	1	
12	300725	Wood screw bracket to dashboard	2	
13	26264	Lock striker glove box lock	1	
14	4163	Self tapping screw lock striker to dashboard	2	
15	3120	Pointed screw dashboard to ‚A‘ post	2	
16	212192	Spring washer	2	
17	205414	Wood dashboard walnut - LHD models	1	} For further information see chapter 21.24
17	21257	Wood dashboard elm - LHD models	1	
17	307126	Wood dashboard walnut - RHD models	1	
17	21256	Wood dashboard elm - RHD models	1	
18	26263	Check strap glove box lid	1	
19	302553	Wood screw strap to dashboard	2	
20	448789	Countersunk screw strap to glove box lid	2	
21	20115	Hinge glove box lid	2	
22	300726	Wood screw hinge to dashboard	4	
22	300725	Wood screw hinge to glove box lid	10	
23	9647	Countersunk screw wood dashboard to metal panel	5	
24	9651	Cup washer	5	
25	118	Lock glove box	1	} With two keys
26	329195	Key key code: FA	1	
26	6339	Key key code: FS	1	
26	299474	Key key code: FT	1	
27	1679	Handle glove box lid - chromed	1	
28	300782	Lever air vent	1	
29	20786	Knob air vent lever	1	
30	5695	Self tapping screw knob to lever	1	
31	300827	Retainer	1	
32	6306	Double coil washer	1	
33	300833	Rivet	1	
34	300760	Seal fresh air duct to plenum chamber	2	
35	300796	Fresh air duct LH	1	
35	300797	Fresh air duct RH	1	
36	4163	Self tapping screw fresh air duct to dashboard	6	
37	3088	Spire nut	4	
38	300755	Air flap LH fresh air duct	1	
38	300756	Air flap RH fresh air duct	1	
39	10689	Retaining clip	2	
40	300757	Spindle air flap	2	
41	7794	Plain washer	2	
42	300759	Pivot pin air flap adjuster	2	
43	300758	Adjuster air flap	2	
44	300830	Spire nut	2	
45	300465	Seal fresh air duct to dashboard	2	
46	469762	Grille LH fresh air duct	1	
46	296271	Grille RH fresh air duct	1	

14.14

Electrics

Dashboard - TR4A

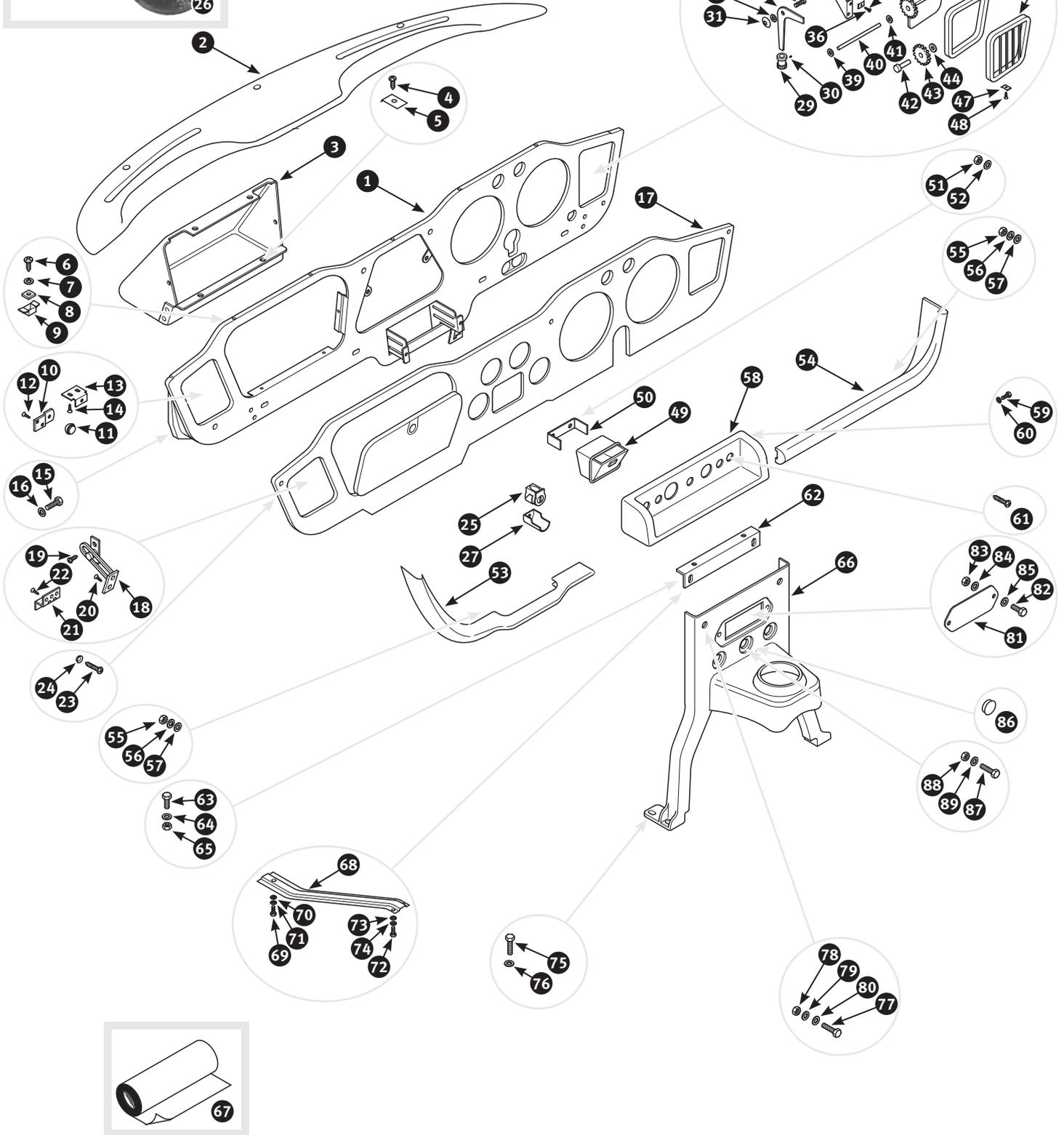

No	Part No	Description	Qty	Notes
47	4163	Self tapping screw grille to dashboard.	4	} May replace original fixing
48	19416	Spire nut grille to dashboard	4	
49	10270	Ashtray	1	
50	300774	Bracket ashtray	1	
51	212190	Spring washer	1	
52	215477	Nut ashtray to bracket	1	} LHD
53	2546	Crash pad below dashboard, LH - no grab handle.	1	
54	11484	Crash pad below dashboard, RH - with grab handle	1	} RHD
53	296894	Crash pad below dashboard, LH - with grab handle	1	
54	10994	Crash pad below dashboard, RH - no grab handle	1	
55	215477	Nut crash pad to dashboard.	6	
56	212190	Spring washer	6	
57	7793	Plain washer	6	
58	11317	Switch plinth	1	
59	7884	Screw switch plinth to dashboard	1	
60	212192	Spring washer	1	
61	18923	Self tapping screw switch plinth to dashboard	2	
62	293508	Bracket centre console to dashboard.	1	
63	7893	Screw bracket to dashboard.	2	
64	212193	Plain washer	2	
65	7455	Nyloc nut	2	
66	316691	Centre console - new item	1	
66	316692	Centre console - used item.	1	
67	316743	Vinyl material centre console, black.	1	
67	328309	Leather material centre console, black.	1	
68	462467	Bracket dashboard to bulkhead - new item	1	
68	200520	Bracket dashboard to bulkhead - used item.	1	
69	7885	Screw bracket to bulkhead.	1	
70	212192	Spring washer	1	
71	212191	Plain washer	1	
72	214337	Panhead screw bracket to dashboard	2	
73	212190	Spring washer	2	
74	7793	Plain washer	2	
75	3072	Screw centre console to floor panel.	4	
76	212191	Plain washer	4	
77	10376	Screw centre console to bracket - chromed	2	
78	7455	Nyloc nut	2	
79	212193	Plain washer	2	
80	10387	Plain washer chromed	2	
81	1876	Radio blanking plate	1	
82	227458	Countersunk screw blanking plate to centre console	2	
83	215477	Nut	2	
84	212190	Spring washer	2	
85	20055	Plain washer	2	
86	7809	Blanking plug to blank heater cable holes	2	} Cars without heater unit
87	10376	Screw to blank heater switch hole - chromed	1	
88	2303	Nut	1	
89	212194	Spring washer	1	

14.15

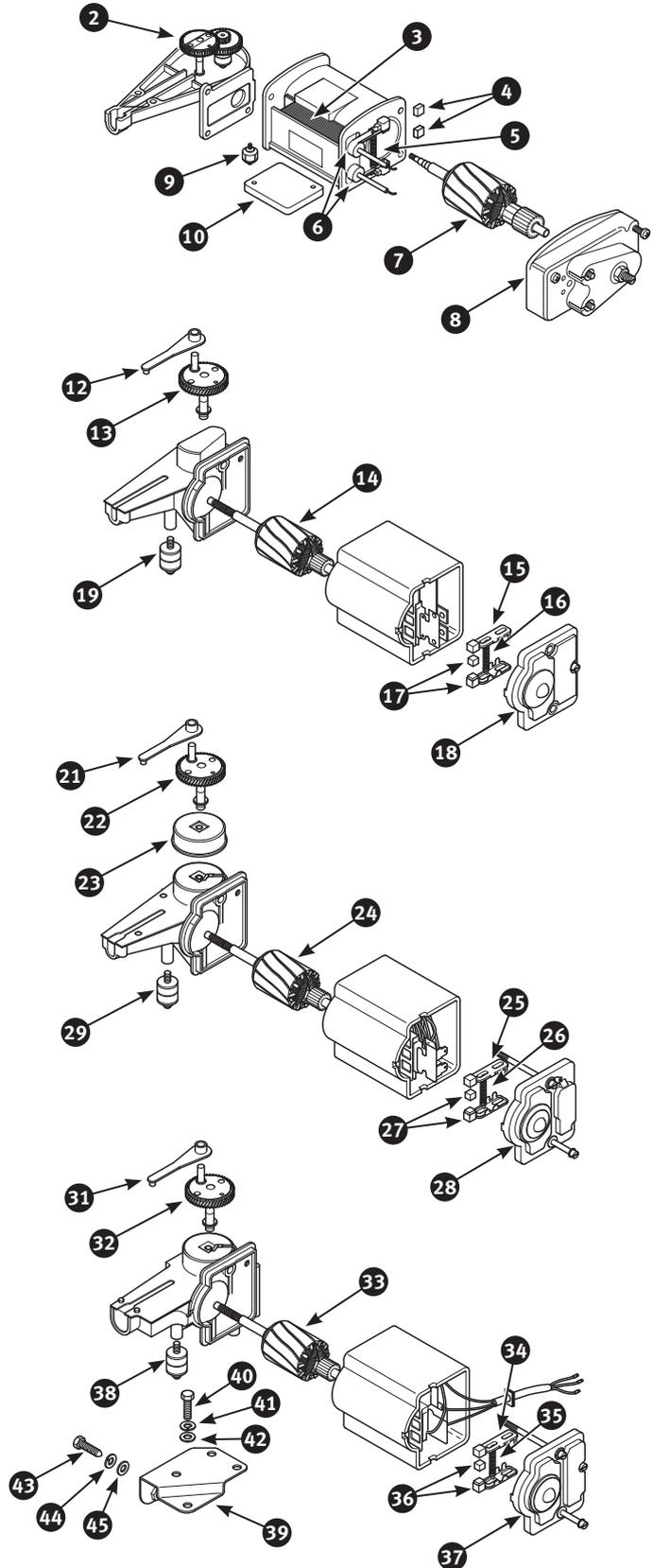
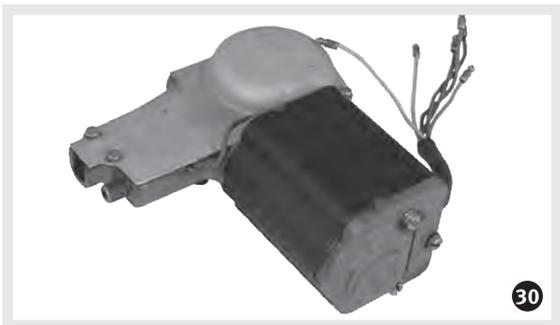

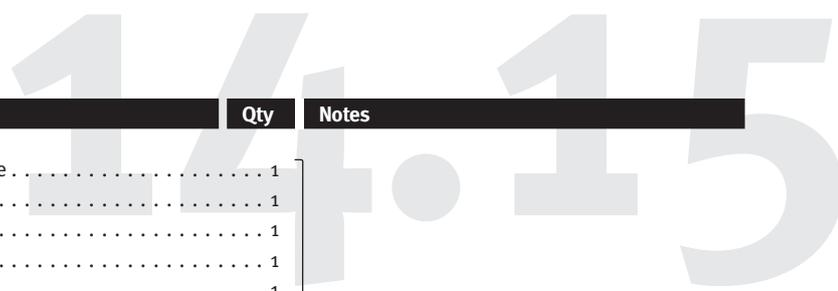

No	Part No	Description	Qty	Notes
1	18153	Wiper motor less drive gear - exchange	1	TR2, TR3 to TS12567. Lucas CRT type wiper motor with single speed
2	472253	Drive gear	1	
3	337839	Coil	1	
4	10670	Brush set	1	
5	292995	Spring brush set	1	
6	295850	Brushgear	2	
7	18984	Armature	1	
8	206354	End cover	1	
9	21078	Mounting wiper motor - includes one rubber ferrule, one stud, two plain washers and one nut	1	
10	24990	Pad wiper motor	1	
11	15383	Wiper motor less drive gear - exchange	1	
12	300383	Connecting rod gear to rack	1	
13	5579	Drive gear	1	
14	8541	Armature	1	
15	295853	Brushgear	1	
16	292995	Spring brush set	1	
17	10670	Brush set	1	
18	326286	End cover with bearing	1	
19	10391	Mounting wiper motor - includes one grommet, one bolt, two plain washers and two nuts	3	
20	20800	Wiper motor less drive gear - exchange	1	TR4 RHD from CT7784, TR4 LHD from CT31. Lucas DR3A type wiper motor with single speed
21	299177	Connecting rod drive gear to wiper rack	1	
22	299176	Drive gear	1	
23	293014	Switch parking	1	
24	5554	Armature	1	
25	295248	Brushgear	1	
26	292995	Spring brush set	1	
27	10670	Brush set	1	
28	309557	End cover with bearing	1	
29	10391	Mounting wiper motor - includes one grommet, one bolt, two plain washers and two nuts	3	
30	11413	Wiper motor less drive gear - exchange	1	TR4A (optional equipment for earlier models). Lucas DR3 type wiper motor with two speed
31	299177	Connecting rod drive gear to wiper rack	1	
32	299176	Drive gear	1	
33	5554	Armature	1	
34	295248	Brushgear	1	
35	292995	Spring brush set	1	
36	10670	Brush set	1	
37	309557	End cover with bearing	1	
38	10391	Mounting wiper motor - includes one grommet, one bolt, two plain washers and two nuts	3	
39	338003	Mounting plate - new item	1	
39	26260	Mounting plate - used item	1	
40	7884	Screw mounting plate to bulkhead bracket	1	
41	212192	Spring washer	1	
42	7794	Plain washer	1	
43	317585	Pointed screw mounting plate to bulkhead lower panel.	2	
44	212192	Spring washer	2	
45	7794	Plain washer	2	

14.16

Electrics

Windscreen wiper, rack and wheel box

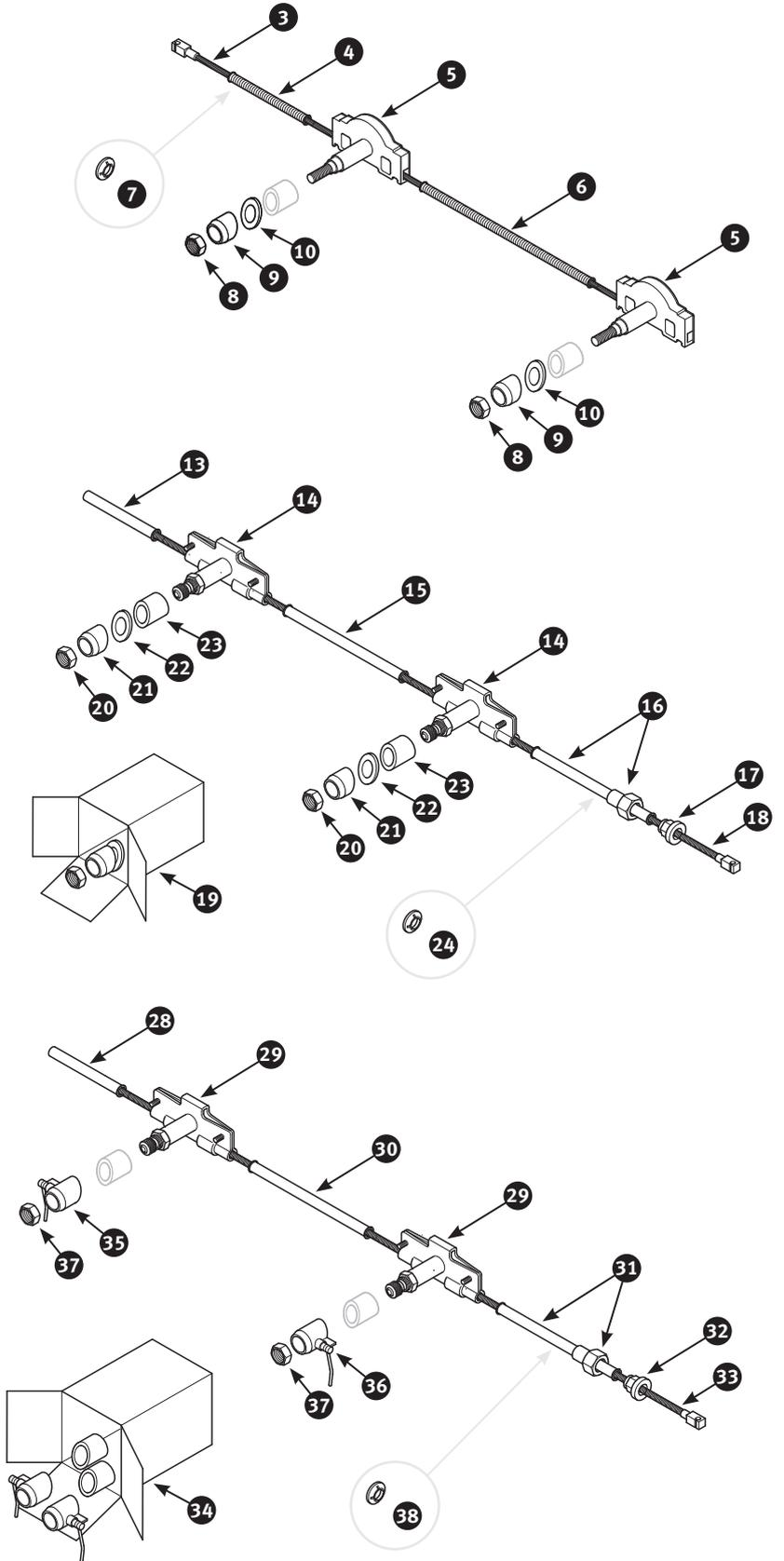

No	Part No	Description	Qty	Notes
1	201958	Wiper arm stainless steel - LHD only	2	TR2, TR3 to TS12567. Main identifier: wiper arms with collet fitment to wheel box and 5.2 mm 'spoon' fitting for wiper blades
1	2358	Wiper arm stainless steel - RHD only	2	
2	2373	Wiper blade stainless steel	2	
3	371043	Rack wheel box driving	1	
4	300386	Casing wiper rack	1	
5	204829	Wheel box	2	
6	300387	Casing wiper rack	1	
7	4285	Grommet	1	
8	21079	Nut wheel box - chromed	2	
9	21080	Chrome bezel wheel box	2	
10	466774	Gasket wheel box	2	TR3 from TS12568, TR3A and TR3B. Main identifier: wiper arms with spline fitment to wheel box and 5.2 mm 'spoon' fitting for wiper blade
11	201960	Wiper arm stainless steel - LHD only	2	
11	2372	Wiper arm stainless steel - RHD only	2	
12	2373	Wiper blade stainless steel	2	
13	292783	Casing wiper rack extension	1	
14	2436	Wheel box	2	
15	18140	Casing wiper rack	1	
16	18139	Casing with nut - wiper rack	1	
17	14310	Ferrule wiper rack casing to wiper motor	1	
18	4607	Rack wheel box driving	1	
19	19706	Bush kit wheel box. Content: nut, bezel and sealing rubber.	2	
20	212889	Nut - separately	2	
21	201246	Chrome bezel - separately	2	
22	480386	Sealing rubber - separately	2	
23	19822	Spacer wheel box	2	
24	209383	Grommet	1	TR4 and TR4A. Main identifier: wiper arms with spline fitment to wheel box and 5.2 mm 'bayonet' fitting for wiper blade
25	2387	Wiper arm stainless steel, straight for driver side - LHD only	1	
25	10624	Wiper arm stainless steel, straight for driver side - RHD only	1	
26	2386	Wiper arm stainless steel, RH cranked for passenger side - LHD only	1	
26	2385	Wiper arm stainless steel, LH cranked for passenger side - RHD only	1	
27	12242	Wiper blade stainless steel - length: 10"	2	
28	292783	Casing wiper rack extension	1	
29	2436	Wheel box	2	
30	14246	Casing wiper rack	1	
31	10523	Casing with nut - wiper rack	1	
32	14310	Ferrule wiper rack casing to wiper motor	1	
33	4607	Rack wheel box driving	1	
34	4196	Bush kit wheel box with jet assembly. Complete car set	1	
35	11294	Jet with bush, RH windscreen washer	1	
36	11293	Jet with bush, LH windscreen washer	1	
37	212889	Nut wheel box - chromed	2	
38	22735	Grommet	1	

Order free of charge:



Tools catalogue

Order free of charge:

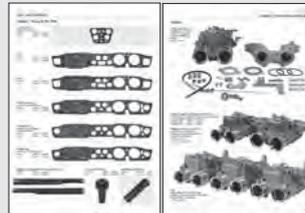

Tuning catalogue

14.17

Electrics

Windscreen washer system

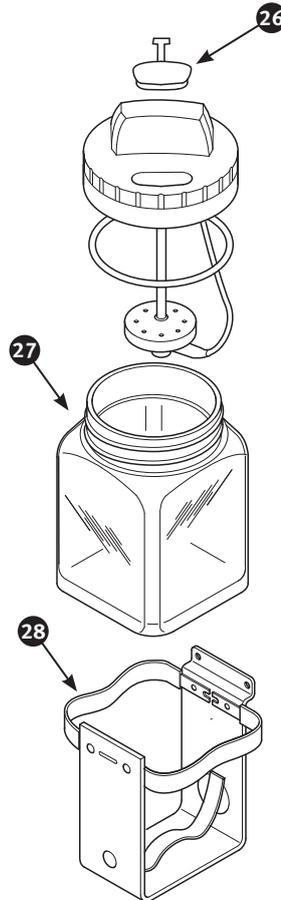
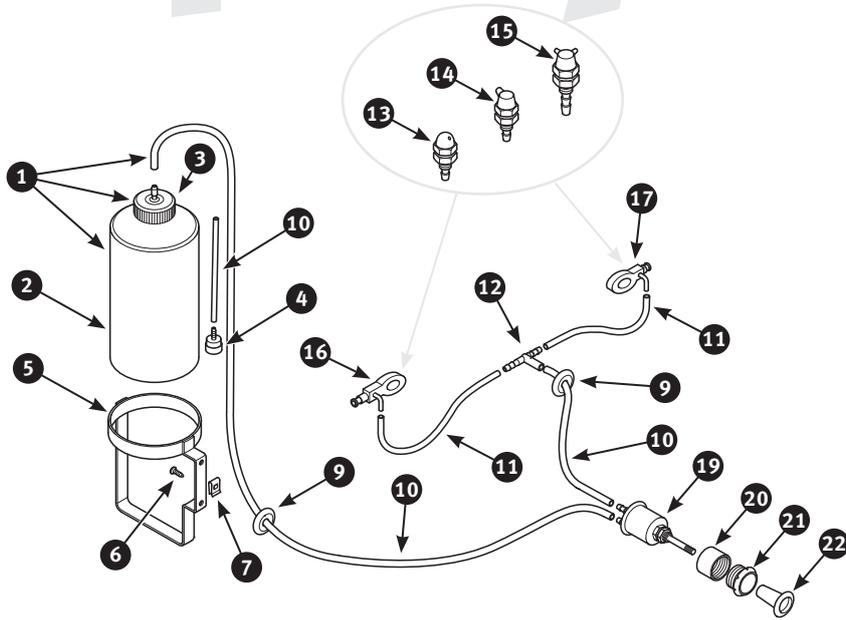

No	Part No	Description	Qty	Notes
1	20592	Washer bottle windscreen wiper	1	} With cap and valve assembly
2	4591	Washer bottle - separately	1	
3	6171	Filler cap - separately.	1	
4	4052	Non-return valve in washer bottle	1	
5	4219	Bracket washer bottle - mild steel.	1	
5	202112	Bracket washer bottle - stainless steel.	1	
6	10741	Screw bracket to inner wing.	2	
7	9656	Spire nut	2	
8	14550	Sticker on washer bottle - ,Tudor' - set of 3.	1	
9	26169	Grommet tubing through bulkhead	2	} Supplied per metre
10	205539	Hose with 1/4" diameter.	2	
11	205538	Hose with 3/16" diameter.	2	} TR2, TR3, TR3A and TR3B - alternatives
12	205533	,T' piece windscreen washer.	1	
13	21092	Jet windscreen washer, original style - single outlet.	2	} TR4 and TR4A
14	3043	Jet windscreen washer, chromed - single outlet.	1	
15	2861	Jet windscreen washer, chromed - twin outlet.	1	} Original style
16	11293	Jet with bush, LH windscreen washer.	1	
17	11294	Jet with bush, RH windscreen washer	1	} May replace original style pump 2130 (ill. 19)
18	4196	Bush kit wheel box with jet assembly. Complete car set	1	
19	2130	Washer pump without knob	1	} Electric screen washer conversion, offered as optional equipment
20	293461	Spacer washer pump	1	
21	293464	Chrome bezel washer pump	1	
22	10448	Knob washer pump	1	
23	25248	Washer pump - replacement.	1	} Content: washer bottle, bracket, non-return valve, manual pump, hose and 2 jets
24	210196	Lucas Washer bottle windscreen wiper, with electric pump and bracket assembly.	1	
25	206819	Sticker for washer bottle - ,Lucas electric screenjet'	1	
26	21088	Filler plug	1	
27	204295	Glass jar	1	
28	212746	Bracket	1	
29	21091	Aftermarket replacement windscreen washer	1	

Conversion kit
to electric windscreen washer system
Part no. 291795



14.18

Electrics

Headlamps

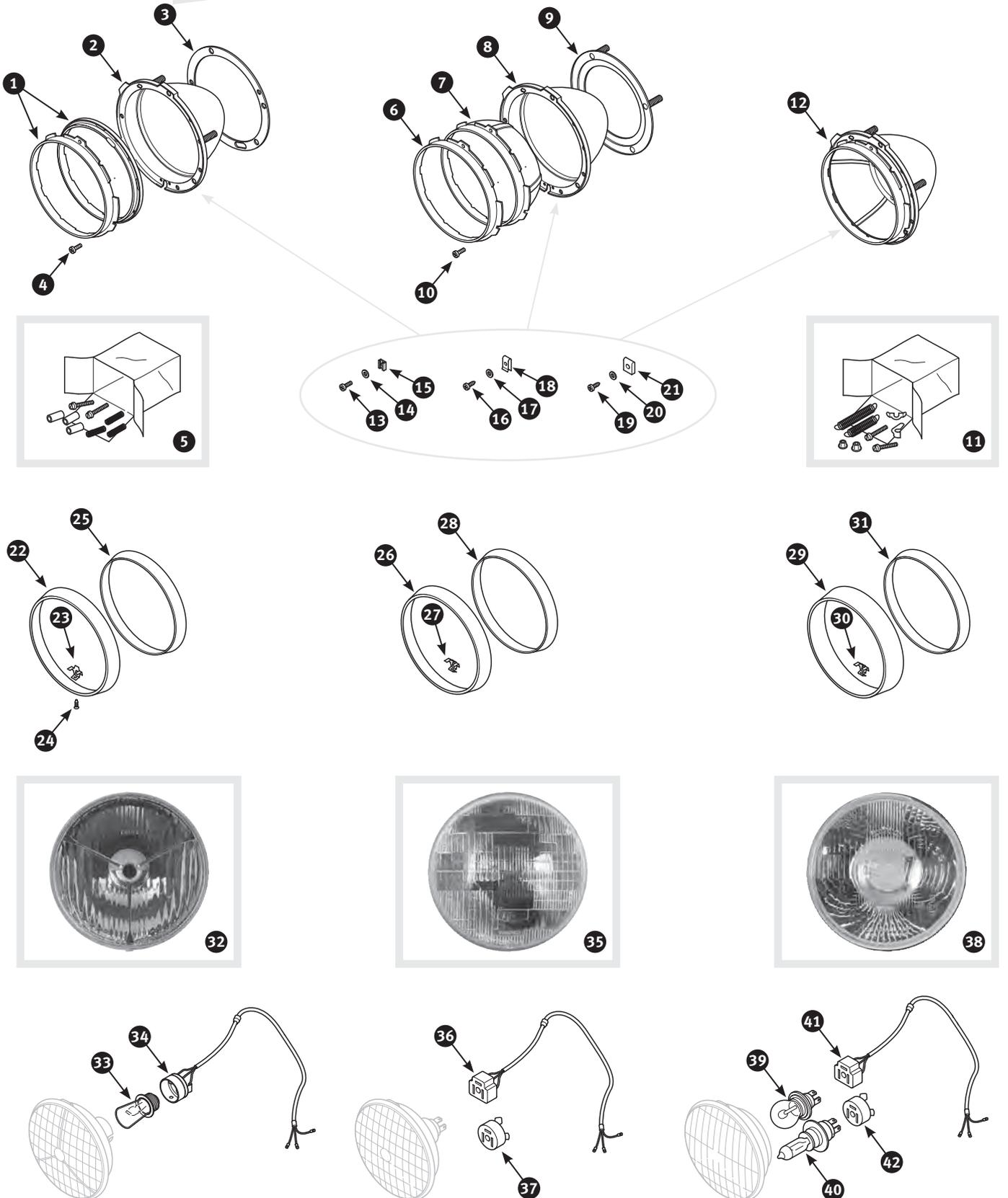

No	Part No	Description	Qty	Notes
1	8540	Retaining rim headlamp	2	Headlamp bowl with 3 adjusters
2	9286	Headlamp bowl metal	2	
3	21672	Gasket headlamp bowl.	2	
4	5693	Self tapping screw rim to headlamp bowl	6	
5	8545	Headlamp adjuster kit	2	
6	204838	Retaining rim headlamp	2	Headlamp bowl with 2 adjusters
7	5021	Headlamp inner bowl metal	2	
7	469767	Headlamp inner bowl plastic.	2	
8	4588	Headlamp bowl metal	2	
8	12134	Headlamp bowl plastic.	2	
9	201952	Rubber seal headlamp bowl	2	Complete with inner rim, rubber seal and adjuster kit
10	5693	Self tapping screw rim to inner headlamp bowl	6	
11	829	Headlamp adjuster kit	2	
12	318470	Headlamp bowl plastic.	2	
12	471322	Headlamp bowl metal	2	
13	7772	Panhead screw headlamp bowl to body.	6	TR2, TR3, TR3A and TR3B.
14	212190	Spring washer headlamp bowl to body	6	
15	21211	Captive nut headlamp bowl to body	6	Original fitment for 9/32" square hole - must be used in sets
16	219012	Self tapping screw headlamp bowl to body	6	
17	1717	Plain washer headlamp bowl to body	6	TR2, TR3, TR3A and TR3B.
18	21210	Spire nut headlamp bowl to body.	6	
19	219012	Self tapping screw headlamp bowl to body	6	Alternative fitment - must be used in sets
20	1717	Plain washer headlamp bowl to body	6	
21	9655	Spire nut headlamp bowl to body.	6	TR4 and TR4A.
22	2445	Chrome rim headlamp - screw-on type	2	
23	13766	Retaining clip for screw-on headlamp rim.	2	Fitment for 7/16" square hole
24	7823	Screw headlamp rim - chromed.	2	
25	4697	Seal headlamp rim.	2	TR2 and TR3
26	4556	Chrome rim headlamp - clip-on type	2	
27	20998	Retaining clip for clip-on headlamp rim - original style	2	
27	209961	Retaining clip for clip-on headlamp rim - replacement.	2	
28	4697	Seal headlamp rim.	2	
29	20836	Chrome rim headlamp - wide, clip-on type.	2	TR3A, TR3B, TR4 and TR4A - all countries less USA and Canada. TR3A USA and Canada exports to TS32584
30	20998	Retaining clip for clip-on headlamp rim - original style	2	
30	209961	Retaining clip for clip-on headlamp rim - replacement.	2	
31	4697	Seal headlamp rim.	2	
32	14215	Tripod headlamp no pilot - LHD only.	2	
32	11102	Tripod headlamp no pilot - RHD only.	2	Cars with Tripod headlamps
33	11481	BPF bulb 50/40 watt - LHD only	2	
33	3498	BPF bulb 50/40 watt - RHD only	2	
34	8919	Connecting harness with plug.	2	

Order free of charge:



Oils and lubricants catalogue

Order free of charge:

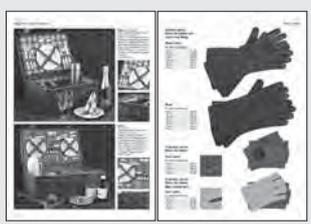

Accessories catalogue

14.18

Electrics

Headlamps

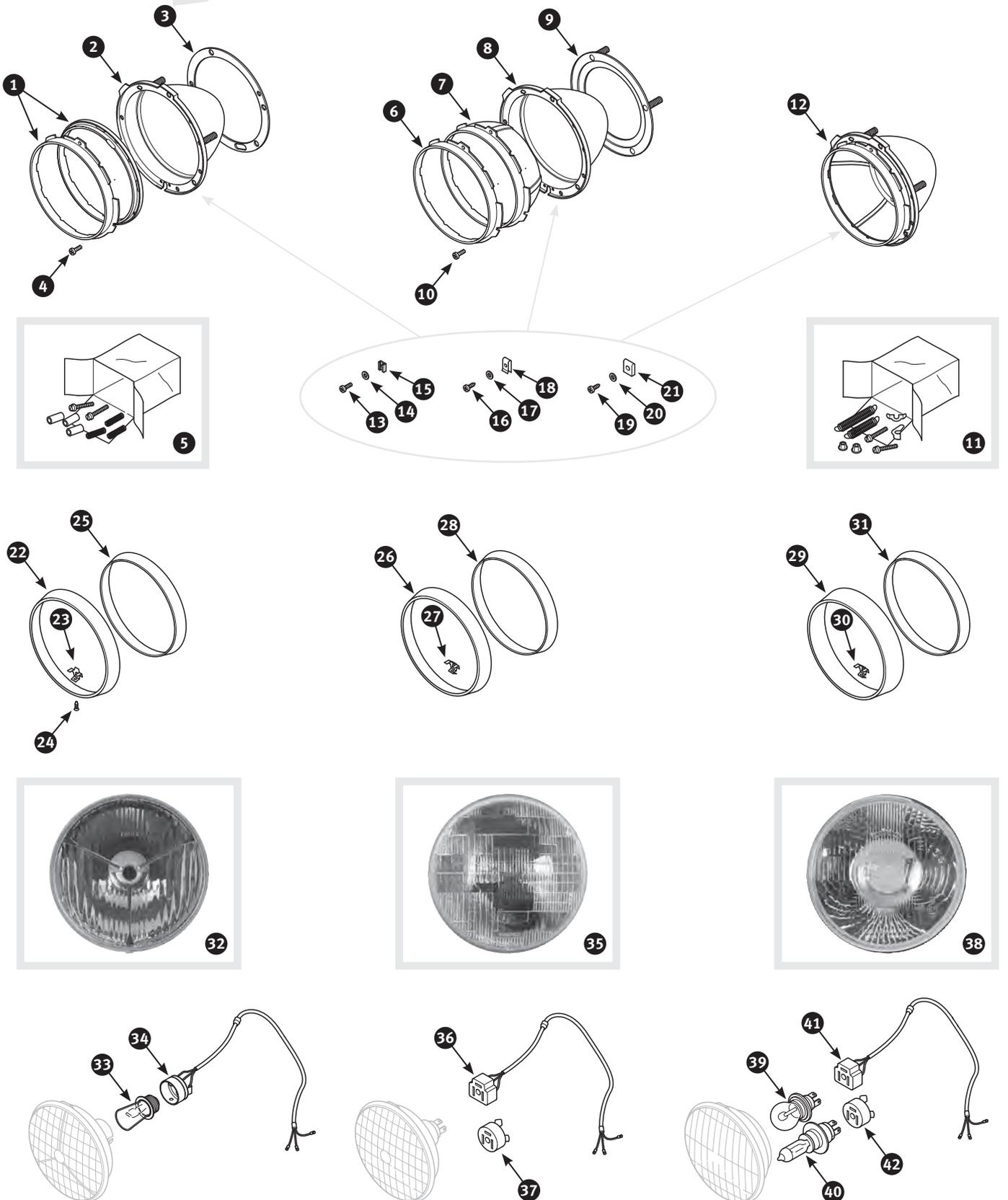

No	Part No	Description	Qty	Notes
35	209939	Sealed Beam headlamp 75/50 watt, with pilot - LHD	2	Cars with Sealed Beam headlamps. Not allowed in Germany
35	209940	Sealed Beam headlamp 75/50 watt, with pilot - RHD	2	
36	6486	Connecting harness with plug	2	
37	18985	Connector kit without harness	2	
38	202389	Bilux headlamp no pilot - LHD only	2	Cars with Bilux headlamps
39	3496	Bilux bulb 45/40 watt, clear bulb surface	2	
39	3497	Bilux bulb 45/40 watt, yellow bulb surface	2	
40	282287	Bilux Halogen bulb 60/55 watt, clear bulb surface	2	
41	6486	Connecting harness with plug	2	
42	18985	Connector kit without harness	2	



H4 Halogen headlamp
7", no pilot

LHD
Part no. 316874

RHD
Part no. 471707

4 Catalogues, you must have:

- Oils and lubricants
- Tuning and more
- Accessories
- Tools



Order online: www.Limora.com • www.scparts.co.uk

14.19

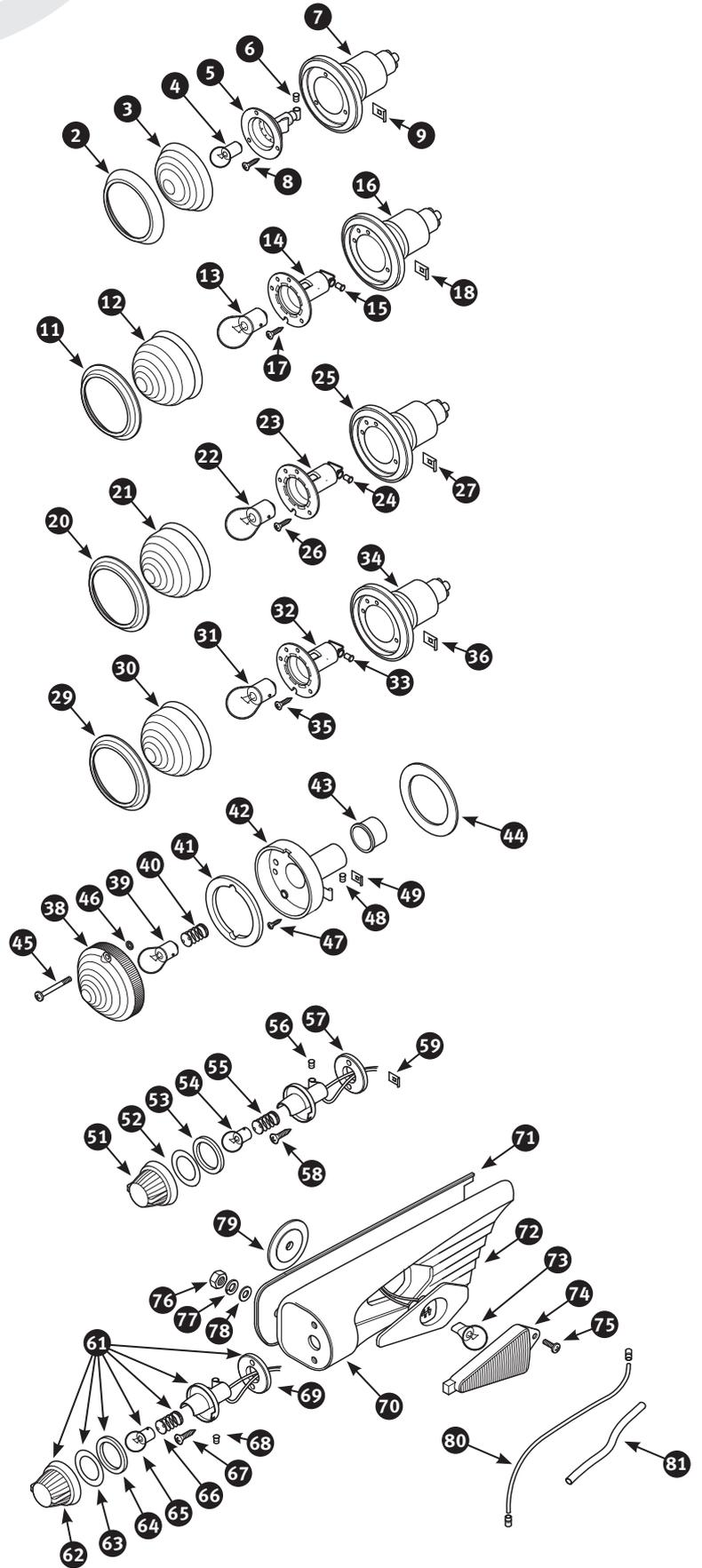
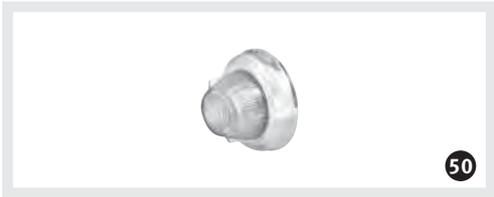

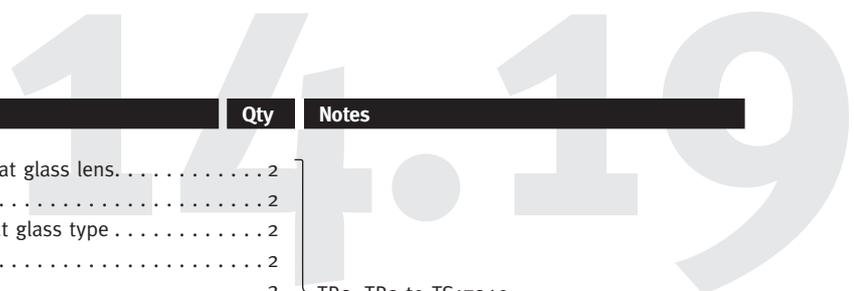

No	Part No	Description	Qty	Notes
1	2438	Lamp side light and indicator - clear flat glass lens.	2	TR2, TR3 to TS17340
2	9279	Chrome rim	2	
3	204820	Lens side light and indicator - clear flat glass type.	2	
4	7476	Bulb side light and indicator.	2	
5	10226	Bulb holder	2	
6	4699	Bullet connector wire to bulb holder	6	
7	15657	Rubber body	2	
8	3818	Self tapping screw lamp to front shroud	6	
9	4955	Spire nut	6	
10	5183	Lamp side light and indicator, clear beehive glass lens	2	
11	9279	Chrome rim	2	
12	9083	Lens side light and indicator - clear beehive glass type.	2	
13	7476	Bulb side light and indicator.	2	
14	324927	Bulb holder	2	
15	4699	Bullet connector wire to bulb holder	6	
16	2457	Rubber body	2	
17	3818	Self tapping screw lamp to front shroud	6	
18	4955	Spire nut	6	
19	8687	Lamp indicator, amber beehive glass lens	2	TR4 and TR4A - all countries less USA, Canada and Italy
20	9279	Chrome rim	2	
21	5186	Lens indicator - amber beehive glass type.	2	
22	3495	Bulb indicator.	2	
23	5022	Bulb holder	2	
24	4699	Bullet connector wire to bulb holder	4	
25	2457	Rubber body	2	
26	3818	Self tapping screw lamp to front valance.	6	
27	4955	Spire nut	6	
28	9381	Lamp indicator - clear beehive glass lens.	2	
29	9279	Chrome rim	2	
30	9083	Lens indicator - clear beehive glass type	2	
31	3495	Bulb indicator.	2	
32	5022	Bulb holder	2	
33	4699	Bullet connector wire to bulb holder	4	
34	2457	Rubber body	2	
35	3818	Self tapping screw lamp to front valance.	6	
36	4955	Spire nut	6	
37	15293	Lamp indicator - clear beehive plastic lens.	2	TR4 from body no. 30349CT, TR4A - USA, Canada and Italy exports only
38	15292	Lens indicator - clear beehive plastic type	2	
39	3495	Bulb indicator.	2	
40	4691	Bulb holder with spring	2	
41	1749	Gasket lens to lamp base.	2	
42	212938	Base	2	
43	4605	Rubber cover lamp base.	2	
44	19809	Gasket lamp to front valance	2	
45	18912	Panhead screw lens to lamp base.	4	
46	8746	Rubber washer on screw	4	
47	10741	Screw lamp to front valance.	6	TR4
48	4955	Spire nut	6	
49	4699	Bullet connector wire to bulb holder	4	
50	4694	Lamp side light - clear plastic lens	2	
51	4721	Lens side light - clear plastic type.	2	
52	13960	Plastic washer	2	
53	13398	Gasket lens to lamp base.	1	
54	3965	Bulb side light.	2	
55	12924	Contact plate with spring	2	
56	4699	Bullet connector wire to bulb holder	4	
57	10577	Gasket lamp to front valance	2	
58	5027	Self tapping screw lamp to front valance	4	
59	4955	Spire nut	4	

14.19

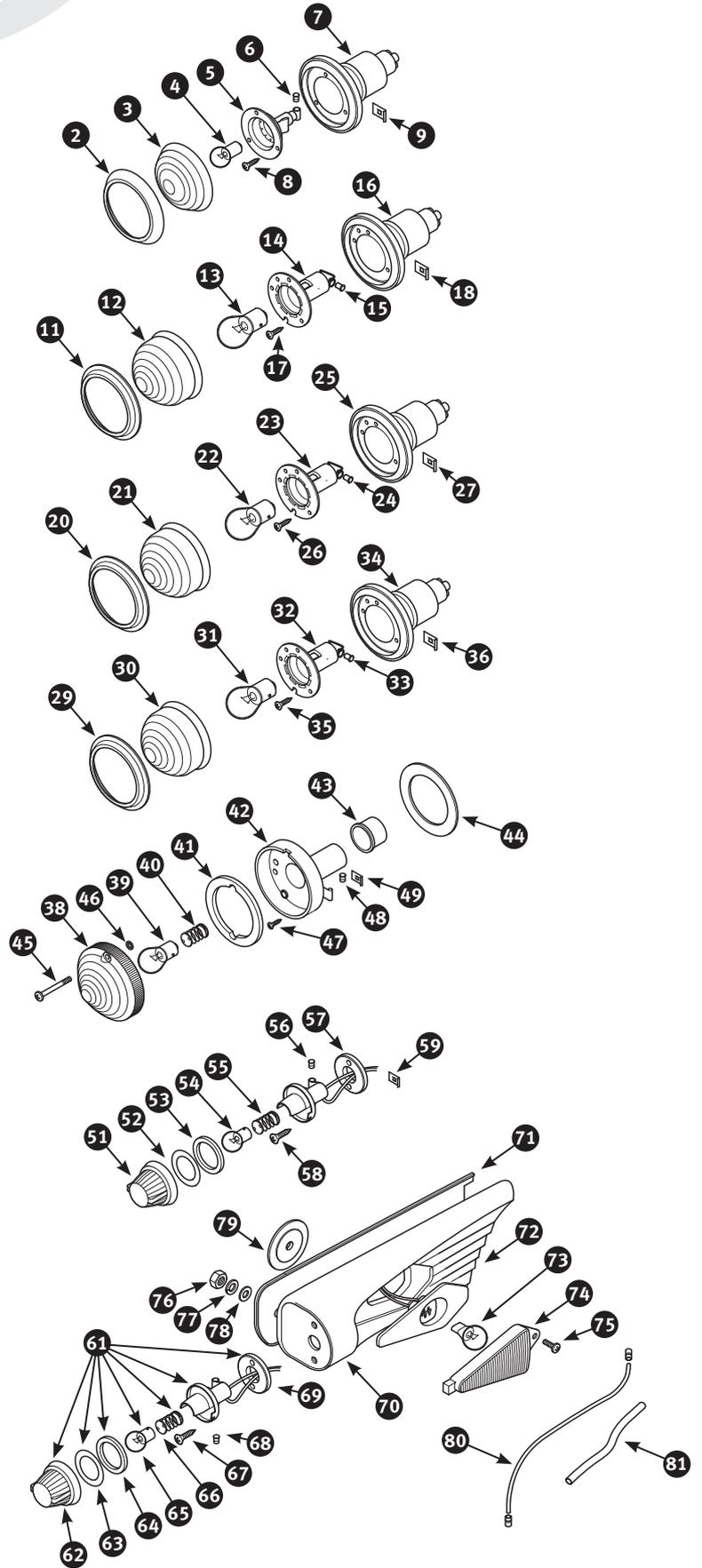
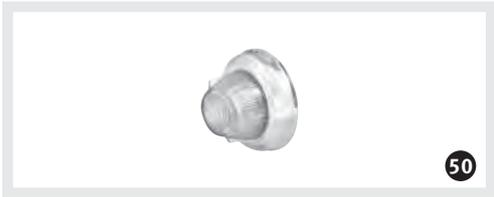

14.20

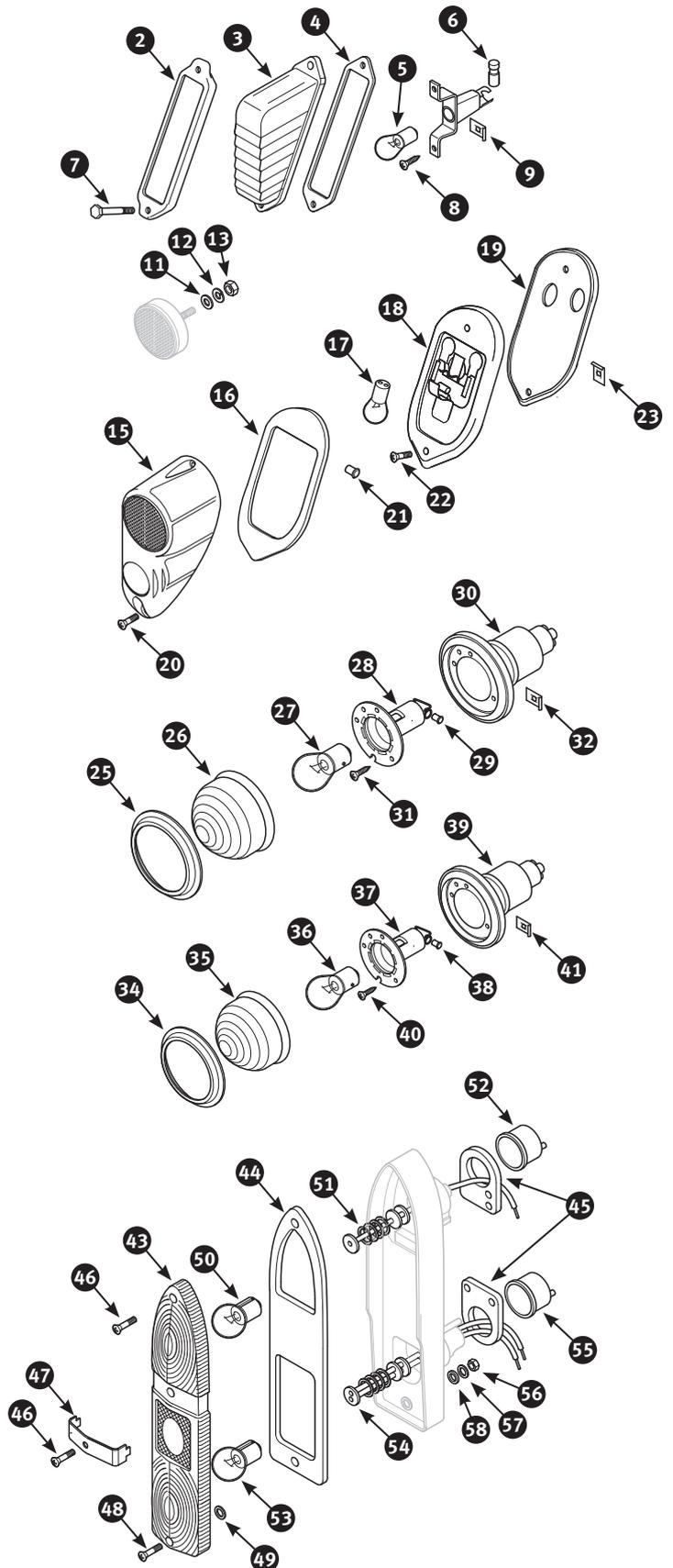

1419

No	Part No	Description	Qty	Notes	
60	212973	Lamp side light/indicator, on LH front wing - lenses: white/amber . . . 1		TR4A	
60	212972	Lamp side light/indicator, on RH front wing - lenses: white/amber . . . 1			
61	4694	Lamp side light - clear plastic lens 2			
62	4721	Lens side light - clear plastic type 2			
63	13960	Plastic washer 2			
64	13398	Gasket lens to lamp base 2			
65	3965	Bulb side light. 2			
66	12924	Contact plate with spring 2			
67	5027	Self tapping screw lamp to housing. 4			
68	4699	Bullet connector wire to bulb holder 4			
69	10577	Gasket lamp to housing 2			
70	203885	Housing LH side/repeater lamp 1			
70	212971	Housing RH side/repeater lamp 1			
71	10546	Gasket side/repeater lamp to LH wing 1			
71	10547	Gasket side/repeater lamp to RH wing 1			
72	293509	Gasket with bulb holder 2			
73	202445	Bulb repeater 2			
74	10531	Lens repeater - ambler plastic type 2			
75	296946	Screw repeater lens to housing 2			
76	2828	Nut side/repeater lamp to front wing 4			
77	212192	Spring washer 4			
78	212191	Plain washer 4			
79	26169	Grommet wires through inner wing 2			
80	20976	Cable indicator to main loom - colour: green 0			Quantity as required
80	20975	Cable side light to main loom - colour: red 0			
80	20977	Cable lamp to chassis earth - colour: black 0			
81	20978	PVC sleeve for wires - length: 1 metre 0			



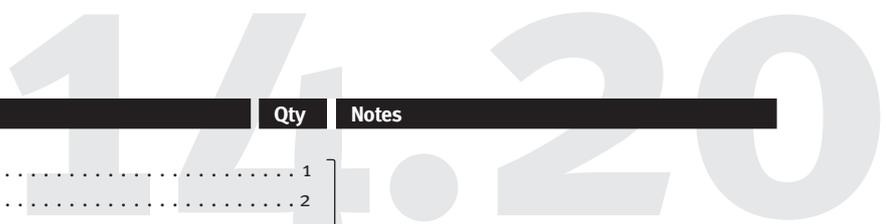

No	Part No	Description	Qty	Notes	
1	20999	Lamp rear - lens: red	1	TR2 to TS1306	
2	300213	Chrome bezel rear lamp	2		
3	326544	Lens rear lamp - red glass type.	2		
3	17481	Lens rear lamp - red plastic type.	2		
4	300215	Gasket lens to body.	2		
5	7476	Bulb rear light and indicator.	2		
6	4699	Bullet connector wire to bulb holder	6		
7	300214	Screw rear lamp to wing	4		
8	219012	Self tapping screw bulb holder to wing	4		
9	3824	Spire nut	4		
10	11326	Reflector - red.	2		
11	7793	Plain washer	2		
12	212190	Spring washer	2		TR2 from TS1307, TR3, TR3A and TR3B
13	6308	Nut reflector to rear wing	2		
14	8412	Lamp rear - lens: red	2		
15	744	Lens rear lamp - red plastic type.	2		
16	6300	Gasket lens to lamp base.	2		
17	7476	Bulb rear light and indicator.	2		
18	6301	Base rear lamp	2		
19	6302	Gasket rear lamp to wing	2		
20	14366	Screw lens to lamp base	4		
21	4699	Bullet connector wire to bulb holder	6		
22	219012	Self tapping screw bulb holder to wing	4		
23	3824	Spire nut	4	TR3 from TS15601, TR3A and TR3B - all countries less USA and Canada	
24	8687	Lamp indicator, amber beehive glass lens	2		
25	9279	Chrome rim	2		
26	5186	Lens indicator - amber beehive glass type	2		
27	3495	Bulb indicator.	2		
28	5022	Bulb holder	2		
29	4699	Bullet connector wire to bulb holder	4		
30	2457	Rubber body	2		
31	3818	Self tapping screw lamp to rear valance.	6		
32	4955	Spire nut	6		
33	5397	Lamp indicator, red beehive glass lens	2		
34	9279	Chrome rim	2		TR3 from TS15601, TR3A and TR3B - USA and Canada exports only
35	4702	Lens indicator - red beehive glass type	2		
36	3495	Bulb indicator.	2		
37	5022	Bulb holder	2		
38	4699	Bullet connector wire to bulb holder	4		
39	2457	Rubber body	2		
40	3818	Self tapping screw lamp to rear valance.	6		
41	4955	Spire nut	6		
42	4723	Lamp rear - lens: amber/red	2	TR4 and TR4A - all countries less USA and Canada	
43	4296	Lens rear lamp - amber/red plastic type.	2		
42	20550	Lamp rear - lens: red/red	2	TR4 and TR4A - USA and Canada exports only	
43	4976	Lens rear lamp - red plastic type.	2		

14.20

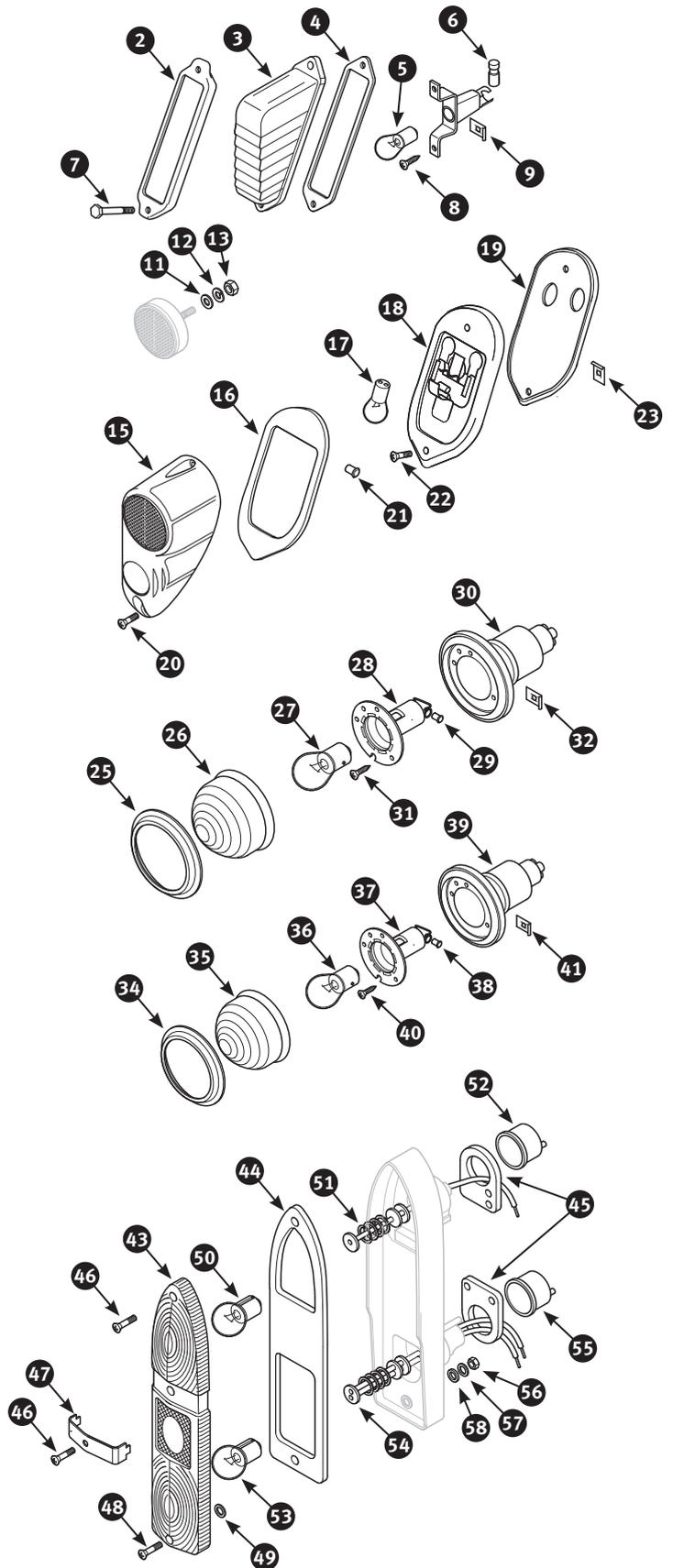

No	Part No	Description	Qty	Notes
44	16270	Gasket lens to lamp base	2	} TR4 and TR4A
45	19397	Gasket rear lamp to wing	4	
46	19395	Screw rear lens to lamp base - top and centre	4	
47	300724	Chrome finisher rear lens	2	
48	19396	Screw rear lens to lamp base - bottom	2	
49	8746	Rubber washer on screw	6	
50	3495	Bulb indicator	2	
51	4691	Bulb holder with spring - indicator	2	
52	4605	Rubber cover indicator bulb holder	2	
53	7476	Bulb stop and rear light	2	
54	9073	Bulb holder with spring - stop/tail lamp	2	
55	297047	Rubber cover stop/tail lamp bulb holder	2	
56	215477	Nut rear lamp to wing	8	
57	212190	Spring washer	8	
58	7793	Plain washer	8	

Battery-Booster

12 volts, for mobile starting power everywhere. Starting current 500 ampere, max. current: 1500 ampere, cable diameter: 25 sq.mm, cable length: 1.2 m. Dimensions: 350 x 320 x 110 mm.

Variant with Euro plug
Part no. 221101

Variant with UK plug
Part no. 330362



14.21

Electrics

Number plate lamps

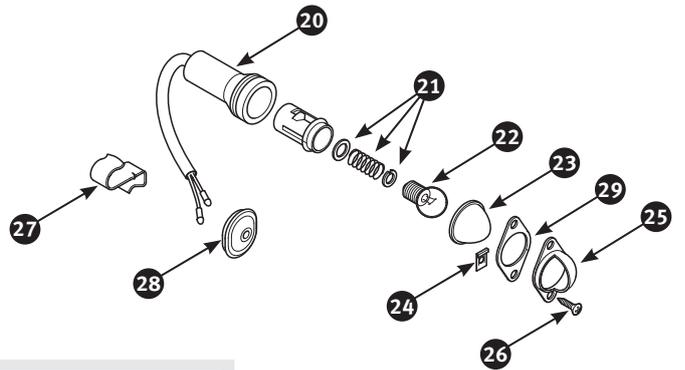
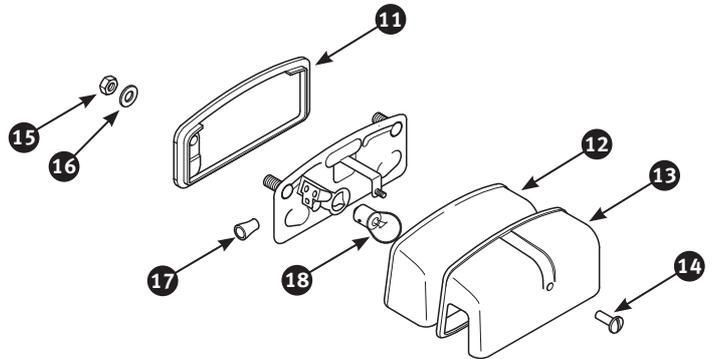
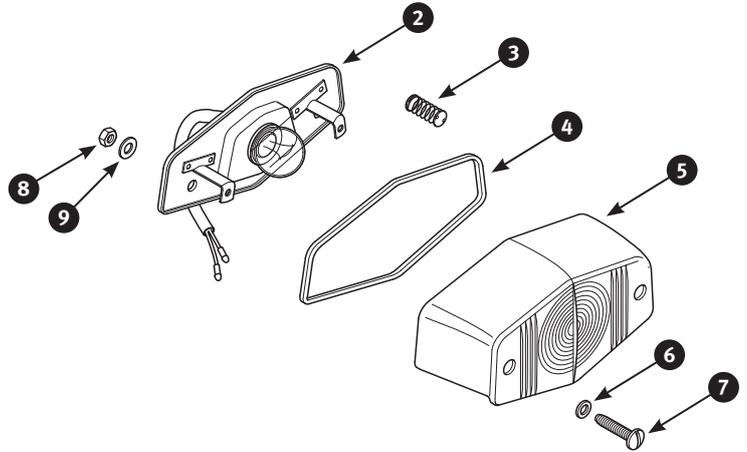

No	Part No	Description	Qty	Notes
1	11803	Number plate lamp with integrated stop light - replacement	1	} TR2, TR3 to TS18912
1	212574	Lucas Number plate lamp with integrated stop light	1	
2	7476	Bulb number plate lamp and stop light	1	
3	9073	Bulb holder with spring	1	
4	300715	Gasket lens to lamp base	1	
5	15304	Lens number plate and stop lamp - red plastic type	1	
6	8746	Rubber washer on screw	2	
7	300714	Screw lens to lamp base	2	
8	6308	Nut lamp to rear valance	2	
9	212190	Spring washer	2	
10	5495	Lucas Number plate lamp chromed	1	} TR3 from TS18913, TR3A and TR3B
10	214949	Number plate lamp chromed plastic - replacement	1	
11	9211	Gasket number plate lamp to rear valance	1	
12	4837	Lens number plate lamp - clear glass type	1	
12	356178	Lens number plate lamp - clear plastic type	1	
13	366	Housing number plate lamp - chromed	1	
14	8544	Screw number plate lamp - chromed	1	
15	6308	Nut number plate lamp to rear valance	2	
16	212190	Spring washer	2	
17	4699	Bullet connector wire to bulb holder	2	
18	2878	Bulb number plate lamp	2	} TR4 and TR4A
19	9678	Number plate lamp chromed	2	
20	299415	Rubber cover on lamp base	2	
21	4691	Bulb holder with spring	2	
22	7472	Bulb number plate lamp	2	
23	1696	Lens number plate lamp	2	
24	4955	Spire nut	4	
25	11349	Chrome finisher number plate lamp - chromed	2	
26	11046	Screw number plate lamp to overrider	4	
27	297052	Clip wire to bumper bracket	2	
28	22735	Grommet lamp wires through rear valance	2	} TR4 to CT6402
29	300191	Plinth number plate lamp - chromed	2	
30	485442	Luster Lace Pad 86 g. can	1	} Ask for our special catalogue.



14.22

Electrics

Heater - TR2, TR3, TR3A and TR3B

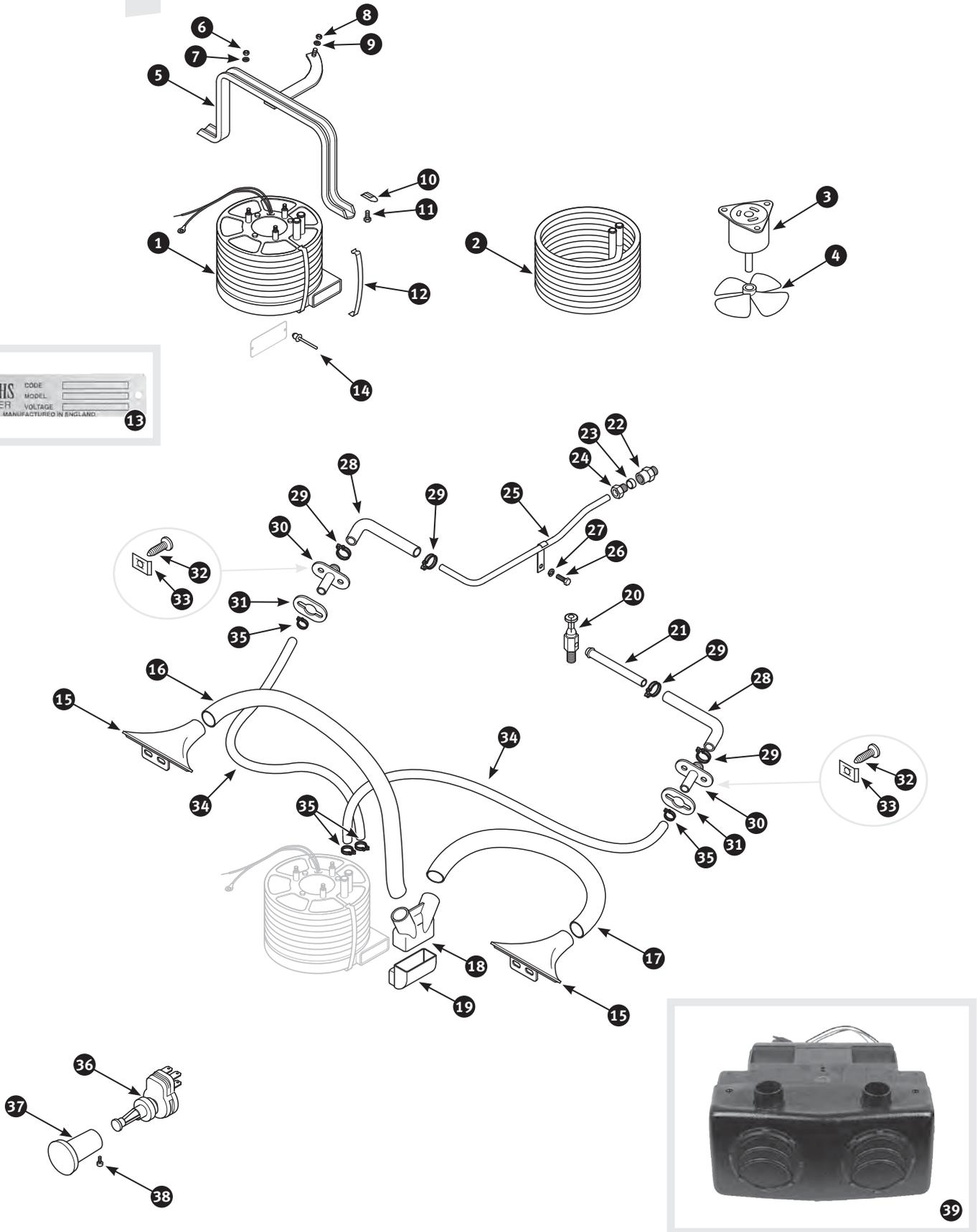
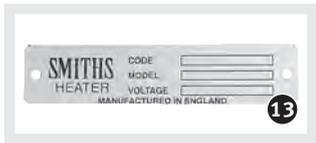

No	Part No	Description	Qty	Notes
1	213873	Heater - complete unit with blower motor	1	
2	16176	Heater matrix original type - 3" deep.	1	
2	481332	Heater matrix uprated type - 4" deep	1	
3	311208	Heater motor	1	
4	323698	Fan blade heater motor	1	
5	213874	Bracket heater support.	1	
6	2828	Nut heater to bracket.	3	
7	212192	Spring washer	3	
8	2828	Nut bracket to dashboard.	1	
9	212192	Spring washer	1	
10	14958	Spire nut bracket to fascia stay.	2	
11	2717	Screw bracket to fascia stay.	2	
12	4080	Retaining clip heater case - length: 3"	2	
12	4225	Retaining clip heater case - length: 4"	2	
13	14035	Plate on heater - ,Smiths Heater'	1	
14	10085	Pop rivet plate to heater case.	2	
15	469703	Demister nozzle windscreen - new item	2	
15	316366	Demister nozzle windscreen - used item	2	
16	20993	Demister tube LH side - length: 24"	1	
17	20992	Demister tube RH side - length: 19"	1	
18	324769	,Y' connector demister tube	1	
19	289566	Elbow ,Y' connector to heater unit	1	
20	11291	Heater valve - screwed in cylinder head.	1	
21	11292	Heater pipe to heater valve	1	
22	216	Adaptor heater pipe to water pump housing	1	} Alternatives
22	337445	Adaptor heater pipe to water pump housing - stainless steel.	1	
23	8078	Olive heater pipe.	1	} Alternatives
24	5483	Nut heater pipe to adaptor.	1	
24	337444	Nut heater pipe to adaptor - stainless steel	1	} Alternatives
25	11252	Heater pipe to water pump housing	1	
25	25348	Heater pipe to water pump housing - stainless steel.	1	
26	212153	Screw heater pipe to cylinder block.	1	
27	212192	Spring washer	1	
28	9737	Heater hose to adaptor in bulkhead	2	
29	1611	Hose clip heater hose	4	
30	2484	Adaptor heater hose through bulkhead	2	} Alternatives
30	323337	Adaptor heater hose through bulkhead - stainless steel	2	
31	2485	Rubber seal on bulkhead adaptor.	2	
32	3817	Self tapping screw fixing adaptor on bulkhead.	4	
33	9658	Spire nut	4	
34	12307	Hose adaptor in bulkhead to heater unit	2	} Alternatives
34	338032	Heater hose adaptor in bulkhead to heater unit - black silicone.	2	
34	338033	Heater hose adaptor in bulkhead to heater unit - green silicone	2	
35	1550	Hose clip heater hose	4	
36	17771	Heater rheostat with switch	1	} Use with push-on knob
37	11296	Knob for heater rheostat - push-on type	1	
37	11295	Knob for heater rheostat - screw-on type.	1	} Later cars
38	21007	Screw for screw-on knob	1	
39	17158	Heater - uprated Xeros unit in plastic case with blower motor	1	} Early cars

14.23

Electrics

Heater - TR4 and TR4A

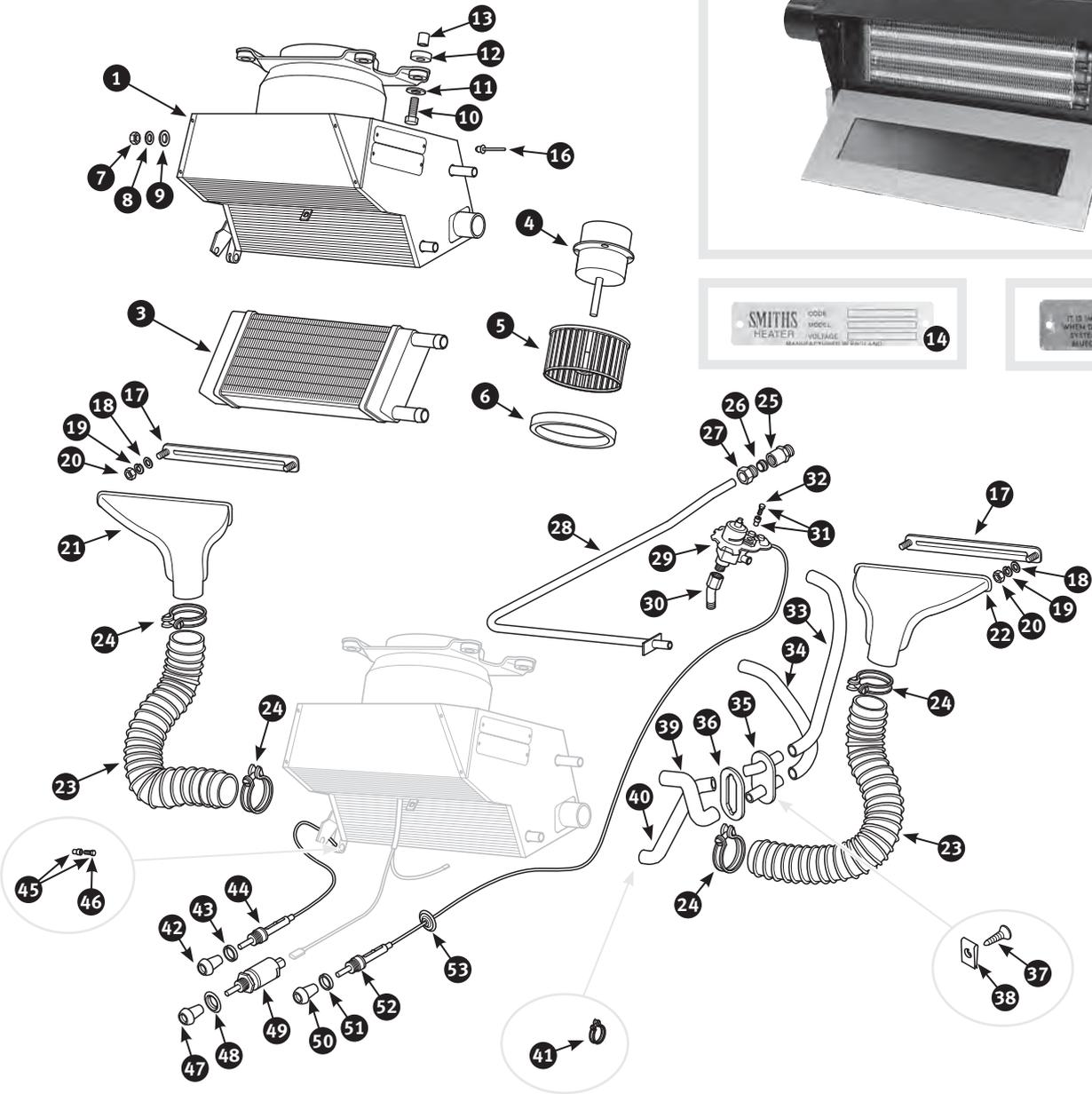

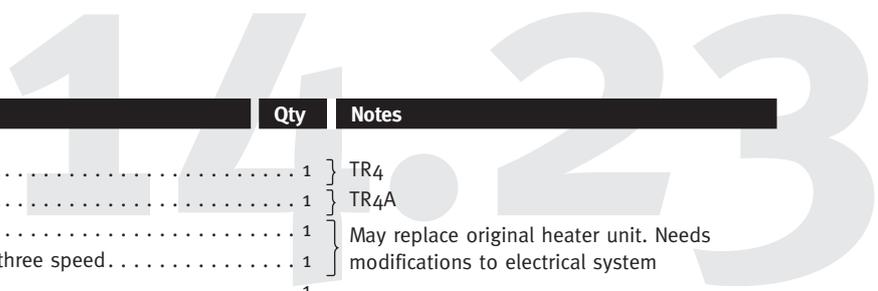

No	Part No	Description	Qty	Notes
1	318855	Heater - original type, single speed	1	} TR4
1	318856	Heater - original type, single speed	1	
1	288872	Heater - replacement, two speed	1	} TR4A
2	481334	Heater - high output replacement, three speed	1	
3	14469	Heater matrix	1	
4	450800	Heater motor two speed	1	} May replace original heater unit. Needs modifications to electrical system
4	310450	Heater motor three speed	1	
5	299154	Fan heater motor - original type	1	
5	310451	Fan heater motor - uprated type	1	
6	450801	Seal heater unit to plenum chamber	1	
7	2828	Nut heater unit to bulkhead	1	
8	7794	Plain washer	1	
9	15373	Rubber washer	1	
10	3072	Screw heater unit to plenum chamber	3	
11	7794	Plain washer	6	
12	243433	Grommet	3	
13	300732	Spacer	3	
14	14035	Plate on heater - ,Smiths Heater'	1	
15	14421	Plate on heater - ,Caution'	1	
16	10085	Pop rivet fixing plates on heater unit.	4	
17	1952	Outlet demister nozzle	2	
18	7793	Plain washer	4	
19	212190	Spring washer	4	
20	215477	Nut	4	
21	448512	Demister nozzle windscreen, RH side - new item	1	
21	214235	Demister nozzle windscreen, RH side - used item	1	
22	448513	Demister nozzle windscreen, LH side - new item.	1	
22	214236	Demister nozzle windscreen, LH side - used item	1	
23	10243	Air hose heater unit to demister nozzle	2	
24	10063	Hose clip air hose	4	
25	216	Adaptor heater pipe to water pump housing	1	} Alternatives
25	337445	Adaptor heater pipe to water pump housing - stainless steel.	1	
26	8078	Olive heater pipe.	1	
27	5483	Nut heater pipe to adaptor.	1	} Alternatives
27	337444	Nut heater pipe to adaptor - stainless steel	1	
28	3919	Heater pipe to water pump housing	1	} Alternatives
28	25349	Heater pipe to water pump housing - stainless steel.	1	
29	4973	Heater valve original type.	1	} Alternatives
29	469884	Heater valve uprated type	1	
30	2391	Adaptor heater valve to cylinder head	1	
31	19467	Trunnion and screw assembly	1	
32	4963	Screw separately	1	
33	2513	Heater hose heater valve to bulkhead adaptor	1	
34	2752	Heater hose heater pipe to bulkhead adaptor	1	
35	1680	Adaptor heater hose through bulkhead	1	} Alternatives
35	15922	Adaptor heater hose through bulkhead - stainless steel	1	
36	15408	Rubber seal on bulkhead adaptor	1	
37	3815	Self tapping screw adaptor to bulkhead.	4	
38	3824	Spire nut adaptor to bulkhead	2	
39	10285	Heater hose heater outlet to bulkhead adaptor	1	
40	10264	Heater hose bulkhead adaptor to heater inlet	1	

14.23

Electrics

Heater - TR4 and TR4A

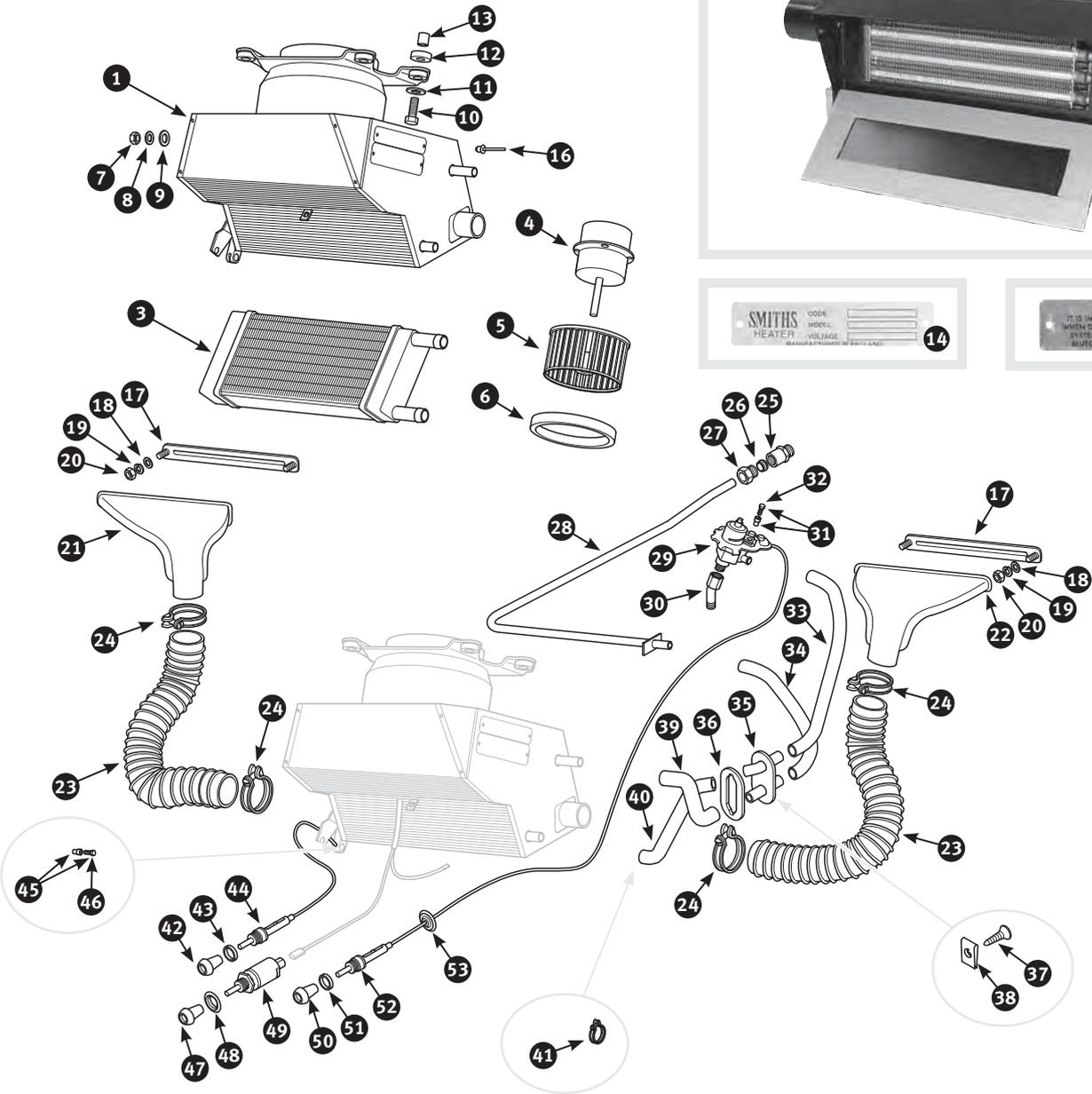

No	Part No	Description	Qty	Notes
41	1611	Hose clip heater hose	8	
42	16906	Knob air distribution cable	1	
43	300733	Nut air distribution cable - chromed	1	
44	10498	Control cable air distribution	1	
45	19467	Trunnion and screw assembly	1	
46	4963	Screw separately	1	
47	16907	Knob heater fan switch	1	
48	18033	Chrome bezel heater fan switch	1	
49	6560	Push/pull switch heater fan.	1	
50	10800	Knob heater cable	1	
51	300733	Nut heater cable - chromed	1	
52	481430	Control cable to heater valve	1	
53	22735	Grommet heater cable	1	
54	310449	Conversion kit to uprated heater. Content: heater matrix, three speed heater motor and fan.	1	
no ill	292187	Conversion kit to air conditioning	1	

Scratch remover for paint finishes/car paint finishes

Unattractive scratches in the paintwork of cars are unavoidable over time. QUIXX Repair System removes scratches, small marks and scuff marks quickly and reliably from all paint finishes (including metallic). Two different special polishes can be used to eliminate both slight and deep scratches. Simply apply the paste and polish. Through the superior action of QUIXX the paint finish shines with a new lustre. This offers an added bonus in maintaining the value of your car, motorcycle, caravan or boat, etc. You'll be amazed!

8-piece set comprising two tubes scratch remover, two polishing cloths, and four strips of special sandpaper.

Scratch remover

„Quixx Repair System“ for car paint.
Contains: 1 tube Quixx Polish Nr.1 - 25g, 1 tube Quixx Finish Nr. 2 - 25g, 2 polishing cloth, 4 special sanding papers
Part no. 226691

Before



After



14.24

Electrics

Fuses and wiring harness fittings

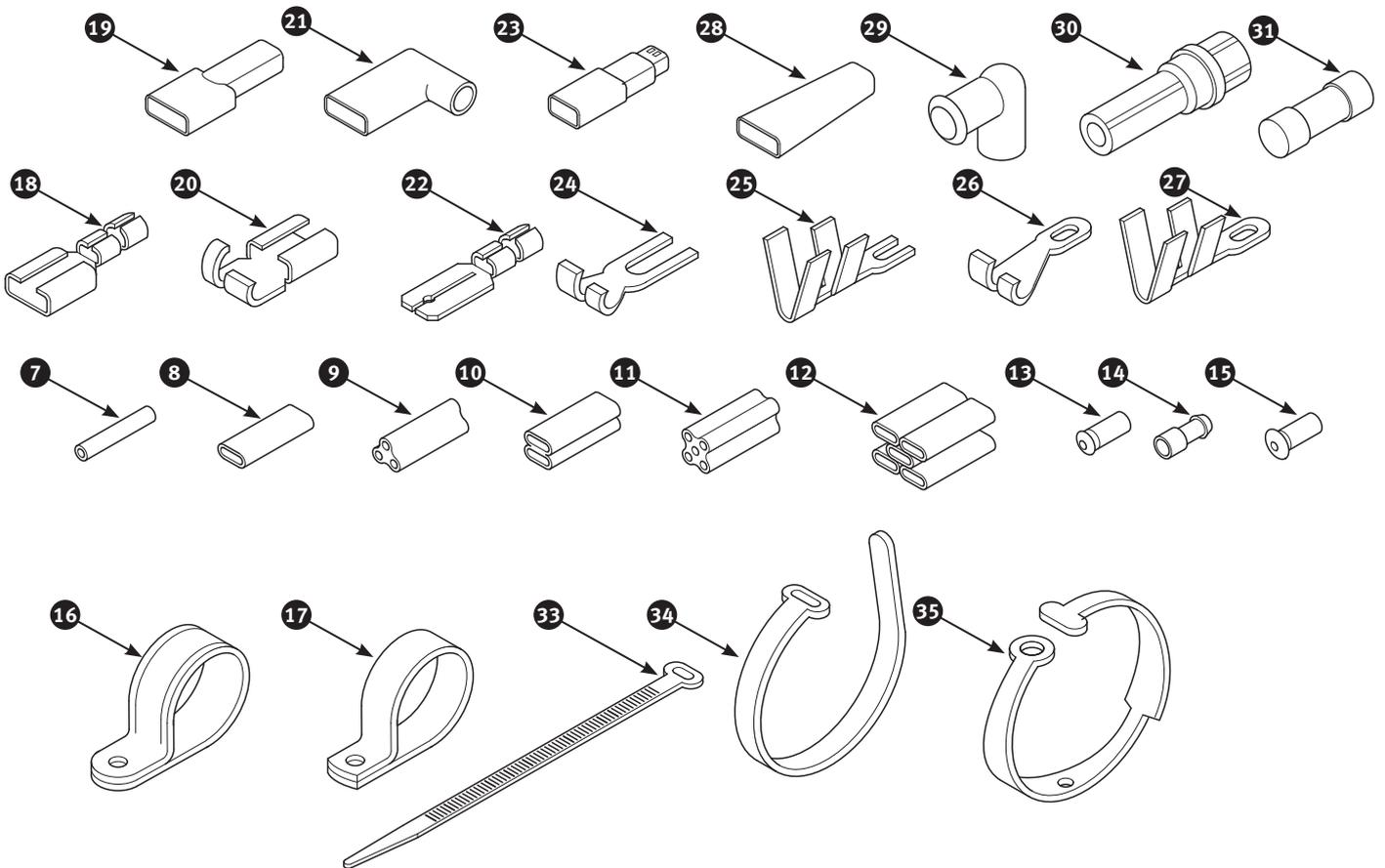

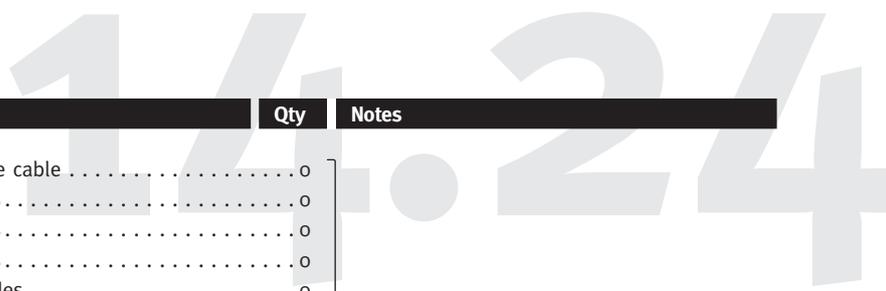

No	Part No	Description	Qty	Notes
1	16625	Bulb holder with screw base, single cable	0	Quantity as required
2	8426	Bulb holder screw type, two cables	0	
3	16626	Bulb holder screw type, two cables	0	
4	216434	Bulb holder screw type, two cables	0	
5	337285	Bulb holder bayonet type, two cables	0	
6	337283	Bulb holder and capless bulb, two cables	0	
7	214673	Female connector 1 in 1	0	
8	13208	Female connector 2 in 2	0	
9	19900	Female connector 3 in 3	0	
10	315575	Female connector 4 in 4	0	
11	250568	Female connector 5 in 5	0	
12	212656	Female connector 10 in 10	0	
13	13220	Bullet connector for soldering - cable cross section: up to 2.00 mm ²	0	
13	318335	Bullet connector for soldering - cable cross section: over 2.00 mm ²	0	
14	318336	Bullet connector for crimping or soldering - cable cross section: 0.65 mm ²	0	
14	318337	Bullet connector for crimping or soldering - cable cross section: 1.00 mm ²	0	
14	318338	Bullet connector for crimping or soldering - cable cross section: 2.00 mm ²	0	
14	318339	Bullet connector for crimping or soldering - cable cross section: 3.00 mm ²	0	
15	4699	Bullet connector for pushing - cable cross section: up to 2.00 mm ²	0	
16	7745	Retaining clip for 3/16" cable and 7/32" hole	0	
16	18131	Retaining clip for 3/16" cable and 9/32" hole	0	
16	7746	Retaining clip for 3/16" cable and 11/32" hole	0	
16	7747	Retaining clip for 1/4" cable and 7/32" hole	0	
16	4249	Retaining clip for 1/4" cable and 9/32" hole	0	
16	7748	Retaining clip for 1/4" calbel and 11/32" hole	0	
16	11844	Retaining clip for 5/16" cable and 7/32" hole	0	
16	18132	Retaining clip for 5/16" cable and 9/32" hole	0	
16	18133	Retaining clip for 5/16" cable and 11/32" hole	0	
16	7749	Retaining clip for 3/8" cable and 7/32" hole	0	
16	7750	Retaining clip for 3/8" cable and 9/32" hole	0	
16	18134	Retaining clip for 3/8" cable and 11/32" hole	0	
16	21622	Retaining clip for 7/16" cable and 11/32" hole	0	
16	4107	Retaining clip for 1/2" cable and 7/32" hole	0	
16	18439	Retaining clip for 1/2" cable and 11/32" hole	0	
16	313692	Retaining clip for 1/2" cable and 13/32" hole	0	
16	7751	Retaining clip for 5/8" cable with 7/32" hole	0	
16	7752	Retaining clip for 5/8" cable and 9/32" hole	0	
16	21625	Retaining clip for 5/8" cable and 11/32" hole	0	
16	208333	Retaining clip for 3/4" cable and 7/32" hole	0	
16	18651	Retaining clip for 3/4" cable and 9/32" hole	0	
16	21626	Retaining clip for 3/4" cable and 11/32" hole	0	
16	317389	Retaining clip for 7/8" cable and 9/32" hole	0	
16	21619	Retaining clip for 7/8" cable with 11/32" hole	0	
16	21620	Retaining clip for 1" cable and 7/32" hole	0	
17	356078	Cable clip PVC - for 3/16" cable and 9/64" hole	0	
17	356079	Cable clip PVC - for 1/4" cable and 9/64" hole	0	
17	356080	Cable clip PVC - for 5/16" cable and 9/64" hole	0	
17	356081	Cable clip PVC - for 3/8" cable and 9/64" hole	0	
17	356082	Cable clip PVC - for 7/16" cable and 9/64" hole	0	
17	356083	Cable clip PVC - for 1/2" cable and 9/64" hole	0	
17	356084	Cable clip PVC - for 5/8" cable and 9/64" hole	0	
17	356085	Cable clip PVC - for 3/4" cable and 9/64" hole	0	
17	356086	Cable clip PVC - for 1" cable and 9/64" hole	0	

14.24

Electrics

Fuses and wiring harness fittings

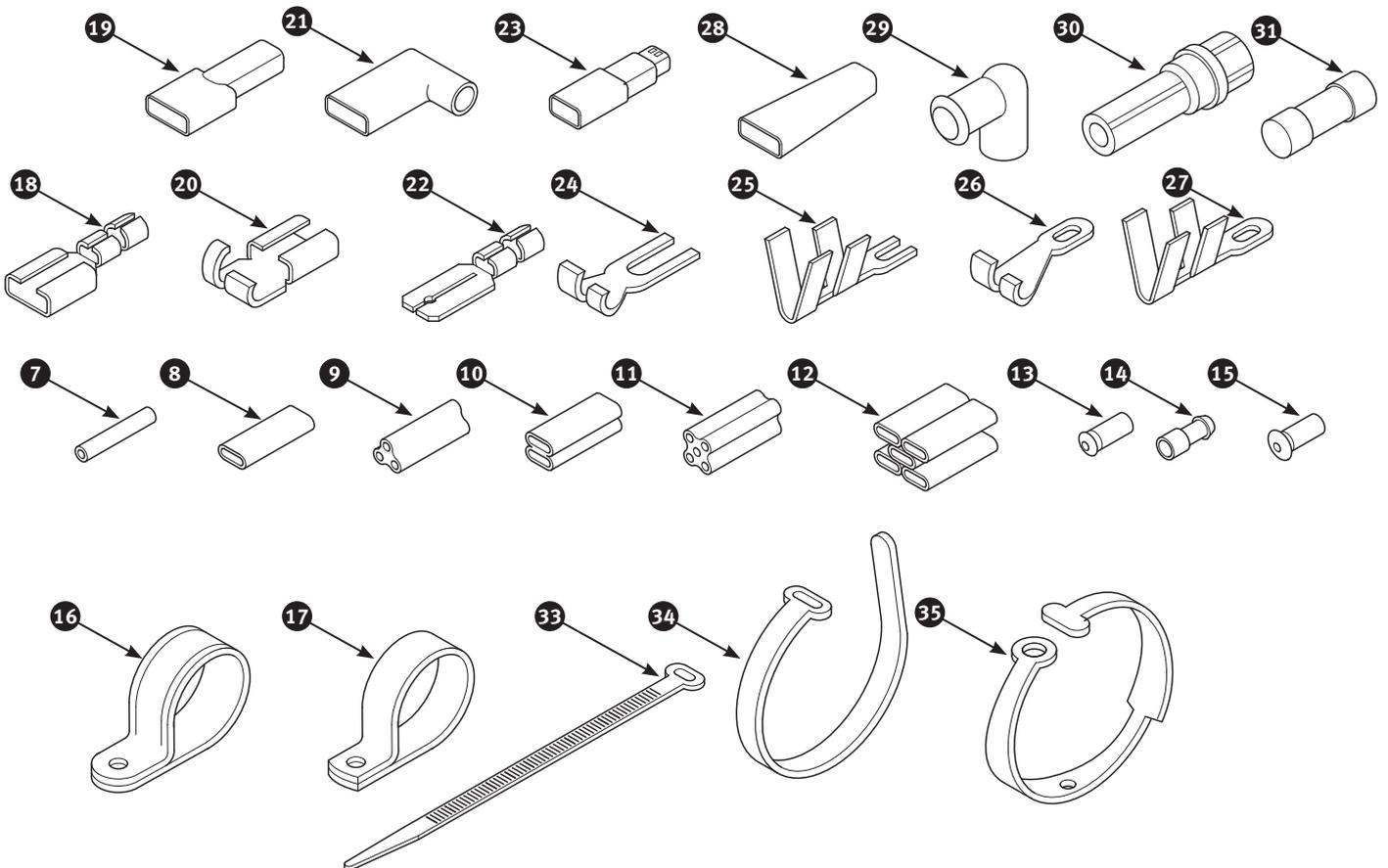

No	Part No	Description	Qty	Notes
18	356055	Connector 1/8" - cable cross section: 1.00 mm ²	0	Quantity as required
19	356064	Insulator for 1/8" lucar connector 356055	0	
18	18657	Connector 3/16" - cable cross section: 2.00 mm ²	0	
19	311420	Insulator for 3/16" lucar connector 18657	0	
18	356057	Connector 1/4" - cable cross section: 1.00 mm ²	0	
19	356066	Insulator for 1/4" lucar connector 356057	0	
18	14779	Connector 1/4" - cable cross section: 2.00 mm ²	0	
19	356066	Insulator for 1/4" lucar connector 14779	0	
18	356058	Connector 1/4" - cable cross section: 4.50 mm ²	0	
19	356067	Insulator for 1/4" lucar connector 356058	0	
18	356059	Connector 1/4" - cable cross section: 2.00 mm ² , Piggy-back type	0	
19	356066	Insulator for 1/4" lucar connector 356059	0	
18	9149	Connector 3/8" - cable cross section: 4.50 mm ²	0	
19	356070	Insulator for 3/8" lucar connector 9149	0	
18	356060	Connector 1/2" - cable cross section: 8.50 mm ²	0	
19	356072	Insulator for 1/2" lucar connector 356060	0	
20	356056	Lucar connector 3/16" - cable cross section: 2.00 mm ²	0	
21	356065	Insulator for 3/16" lucar connector 356056	0	
20	356061	Lucar connector 1/4" - cable cross section: 2.00 mm ²	0	
21	356068	Insulator for 1/4" lucar connector 356061	0	
20	356062	Lucar connector 3/8" - cable cross section: 3.00 mm ²	0	
21	356071	Insulator for 3/8" lucar connector 356062	0	
22	300378	Insulator 3/16" - cable cross section: 2.00 mm ²	0	
23	311420	Insulator for 3/16" lucar connector 300378	0	
22	5556	Insulator 1/4" - cable cross section: 2.00 mm ²	0	
23	356069	Insulator for 1/4" lucar connector 5556	0	
22	14266	Insulator 3/8" - cable cross section: 4.50 mm ²	0	
22	356063	Lucar connector 1/2" - cable cross section: 8.50 mm ²	0	
24	356077	Fork terminal 3/16" - flag type	0	
25	356075	Fork terminal 3/16" - cable cross section: up to 2.00 mm ²	0	
25	356076	Fork terminal 3/16" - cable cross section: over 2.00 mm ²	0	
26	348887	Eyelet 3/16" - cable cross section: 2.00 mm ² , flag type	0	
27	348881	Eyelet 1/8" hole - cable cross section: up to 2.00 mm ²	0	
27	18653	Eyelet 3/16" hole - cable cross section: up to 2.00 mm ²	0	
27	20972	Eyelet 1/4" hole - cable cross section: up to 2.00 mm ²	0	
27	18655	Eyelet 5/16" hole - cable cross section: up to 2.00 mm ²	0	
27	348882	Eyelet 3/8" hole - cable cross section: up to 2.00 mm ²	0	
27	348883	Eyelet 3/16" hole - cable cross section: over 2.00 mm ²	0	
27	348884	Eyelet 1/4" hole - cable cross section: over 2.00 mm ²	0	
27	348885	Eyelet 5/16" hole - cable cross section: over 2.00 mm ²	0	
27	348886	Eyelet 3/8" hole - cable cross section: over 2.00 mm ²	0	
28	356073	Insulator for eyelets with straight terminals (ill. 25 & 27)	0	
29	356074	Rubber boot to suit 3/16" eyelets	0	
30	13666	Inline fuse holder	0	
31	315874	Fuse 5 ampere	0	
31	315868	Fuse 10 ampere	0	
31	315871	Fuse 15 ampere	0	
31	315909	Fuse 25 ampere	0	
31	315911	Fuse 30 ampere	0	
31	15446	Fuse 35 ampere	0	
31	15447	Fuse 50 ampere	0	

14.24

Electrics

Fuses and wiring harness fittings

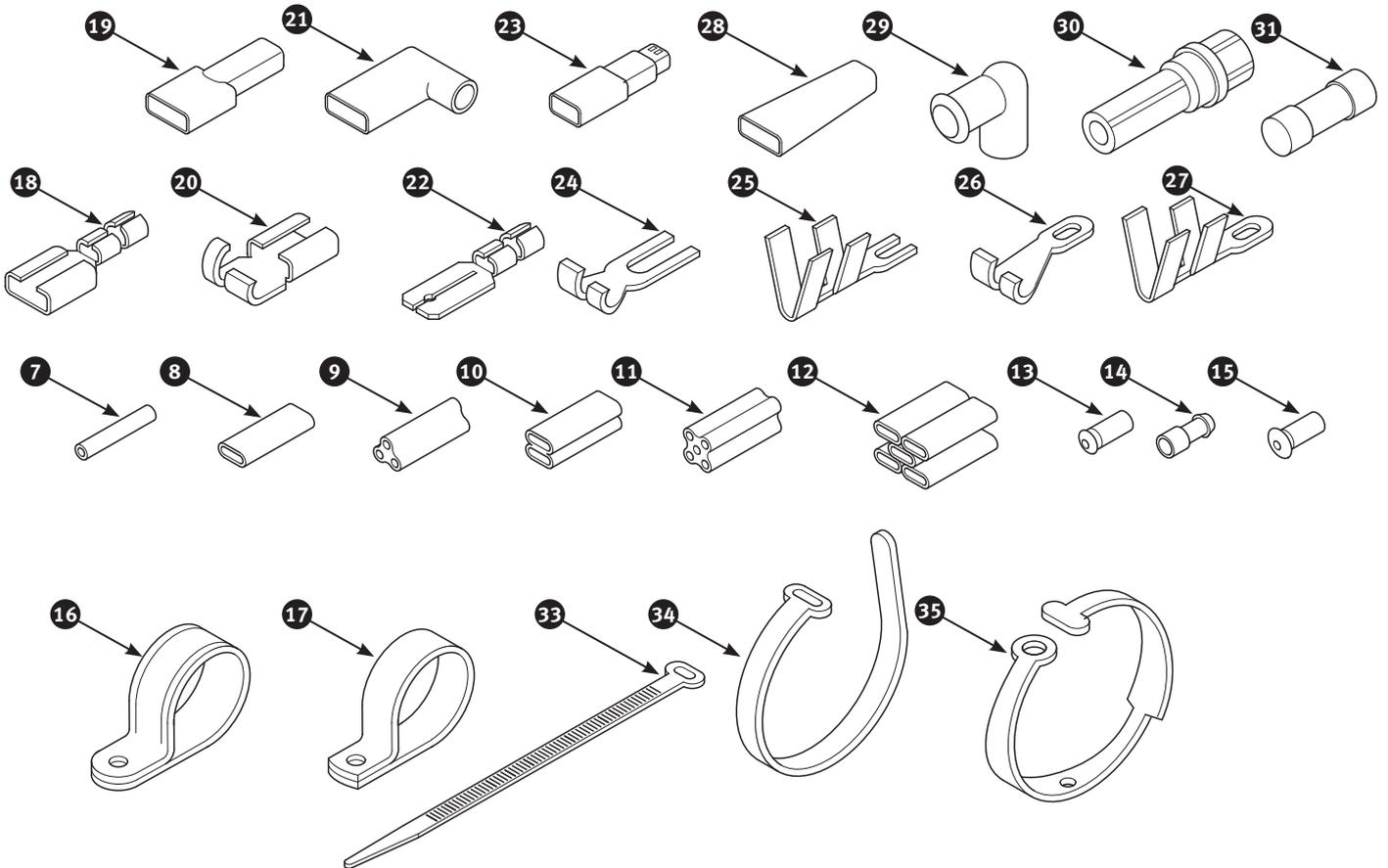

No	Part No	Description	Qty	Notes
32	15548	Fuses 5 ampere - packet of five	0	} Quantity as required
32	18658	Fuses 10 ampere - packet of five	0	
32	14813	Fuses 15 ampere - packet of five	0	
32	12820	Fuses 20 ampere - packet of five	0	
32	17797	Fuses 25 ampere - packet of five	0	
32	315910	Fuses 30 ampere - packet of five	0	
32	15435	Fuses 35 ampere - packet of five	0	
33	8444	Cable strap rubber - alloy - length: 5.1/2"	0	
34	8718	Cable strap alloy - length: 8.3/4"	0	
35	19840	Cable strap plastic - length: 3.1/2"	0	
35	3271	Cable strap plastic - length: 5.1/4"	0	
35	11383	Cable strap plastic - length: 6"	0	
35	19841	Cable strap plastic - length: 8.3/4"	0	
35	19842	Cable strap plastic	0	

Shrinking tube

DUOFLUX consists of a heat-shrinkable polymeric sleeve containing two solder rings with an incorporated flux and two thermoplastic sealing rings. DUOFLUX has been developed especially for making electrical connections, which require high quality, reliability, long life span and water tightness. DUOFLUX is very easy to install, the quality of the connection can be visually checked and it requires no special tools. DUOFLUX comes in four sizes, coded by the international colour code system, and suitable for the most frequent cable diameters. DUOFLUX can be applied on both twisted (flexible) and solid (rigid) conductors, suitable for copper as well as tinned wires, whether combined or not.



Shrinking tube - 'Duoflux'

clear - 0.2 to 0.7 sq. mm
 Part no. 395314

red - 0.7 to 1.5 sq. mm
 Part no. 487277

blue - 1.5 to 2.5 sq. mm
 Part no. 487278

yellow - 3.0 to 6.0 sq. mm
 Part no. 487279

Order free of charge:

Tools catalogue

Order free of charge:

Tuning catalogue

14.25

Electrics

Bulbs

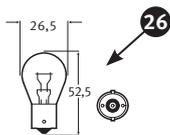
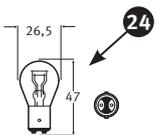
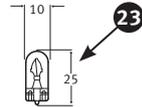
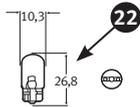
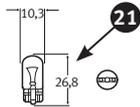
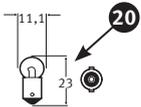
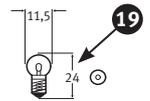
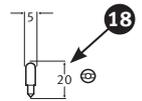
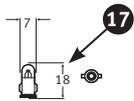
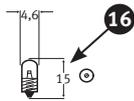
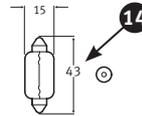
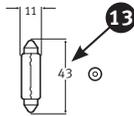
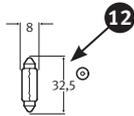
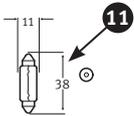
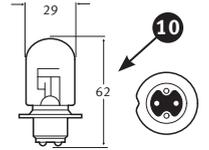
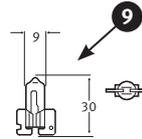
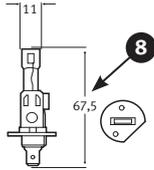
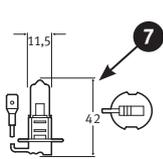
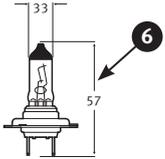
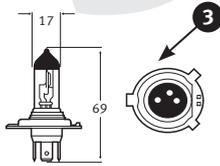
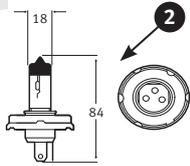
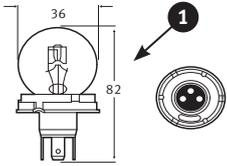

- a)
- b)

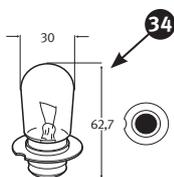
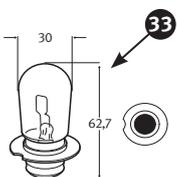
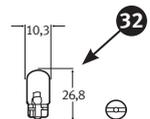
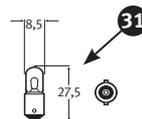
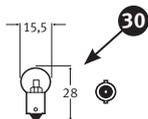
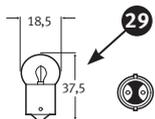
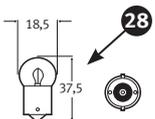

No	Part No	Description	Qty	Notes
1	3496	Bilux bulb 45/40 watt, P45t base	0	} Quantity as required Headlamp
1	3497	Bilux bulb 45/40 watt, P45t base, yellow bulb surface.	0	
2	282287	Bilux Halogen bulb 60/55 watt, P45t base	0	
2	295904	Bilux Halogen bulb 100/80 watt, P45t base	0	
3	2876	Halogen bulb H4 - 60/55 watt, P43t base	0	
3	10222	Halogen bulb H4 - 60/55 watt, P43t base, yellow bulb surface.	0	
4	214422	Halogen bulb H4 - 100/80 watt, P43t base.	0	
4	305032	Halogen bulb H4 - 160/99 watt, P43t base.	0	
5	323060	Halogen bulb H4 - 60/55 watt, P43t base, Xenon	0	
6	307245	Halogen bulb H7 - 55 watt	0	
7	25886	Halogen bulb H3 - 55 watt, PK22s base	0	} Quantity as required Boot, interior, number plate, etc.
8	210425	Halogen bulb H1 - 55 watt, P145s base	0	
8	323061	Halogen bulb H1 - 55 watt, P145s base, Xenon.	0	
9	261140	Halogen bulb H2 - 55 watt, X511 base	0	
10	3498	BPF bulb 50/40 watt, P36D British pre-focus base - RHD.	0	
10	11481	BPF bulb 50/40 watt, P36D British pre-focus base - LHD.	0	
11	2098	Bulb festoon - 5 watt, SV8, 5/8 base	0	
11	318629	Bulb festoon - 10 watt, SV8, 5/8 base	0	
12	10219	Bulb festoon - 3 watt, S7 base	0	
13	10220	Bulb festoon - 10 watt, SV8, 5/8 base	0	
14	202446	Bulb festoon - 18 watt, SV8, 5/8 base	0	} Quantity as required Reverse lamp
14	209949	Bulb festoon - 21 watt, SV8, 5/8 base	0	
15	325393	Halogen bulb 5 watt, BX10D plastic base.	0	} Quantity as required Headlamp
16	2871	Bulb 0.75 watt, E5/8 screw base	0	
16	7473	Bulb 1.5 watt, E5/8 screw base	0	} Quantity as required Instrument and switch illumination
17	261143	Bulb 1.2 watt, BA7S bayonet base.	0	
17	4019	Bulb 2.0 watt, BA7S bayonet base	0	
18	7474	Bulb 1.2 watt, capless base W2, 1x4,6d	0	
19	2877	Bulb 2.2 watt, EP 10 screw base	0	} Quantity as required Instrument panel and interior lamp
20	346900	Bulb 2.2 watt, MCC centre contact base.	0	
21	7478	Bulb 2.2 watt, capless base W2, 1x9.5d	0	} Quantity as required Instrument and switch illumination
22	10223	Bulb 3 watt, capless base W3, 1x9.5d	0	
22	211397	Bulb 2 watt, capless base W3, 1x9.5d	0	
23	317834	Bulb 5 watt, capless base W2, 1x9.5d - amber bulb surface.	0	} Quantity as required Indicator
24	7476	Bulb 21/5 watt, BAY15d bayonet base	0	
25	324511	Bulb 21/5 watt, BAY15d bayonet base - red bulb surface - bayonet pins opposite	0	} Quantity as required Stop and tail lamp
26	3495	Bulb 21 watt, BAY15s bayonet base.	0	
27	317835	Bulb 21 watt, BAY15s bayonet base, amber bulb surface - bayonet pins opposite	0	} Quantity as required Indicator
27	16107	Bulb 21 watt, BAU15s bayonet base, amber bulb surface - bayonet pins not opposite.	0	
28	7472	Bulb 5 watt, BA15s single centre base	0	} Quantity as required Side lamps, number plate illumination
28	2674	Bulb 10 watt, BA15s single centre base	0	
29	202444	Bulb 5 watt, BA15d small bayonet base.	0	
30	2878	Bulb 5 watt, BA9s bayonet base	0	

14.25

Electrics Bulbs

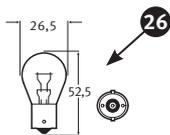
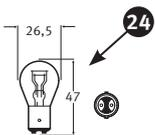
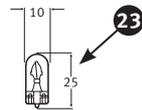
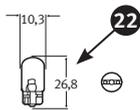
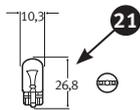
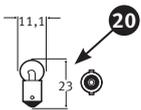
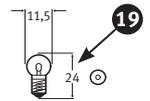
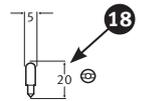
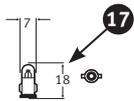
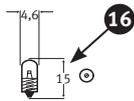
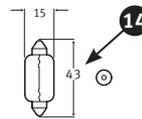
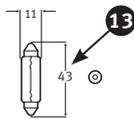
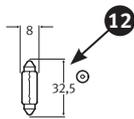
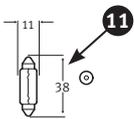
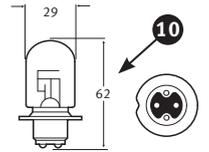
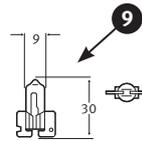
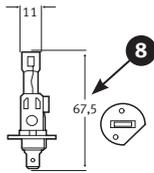
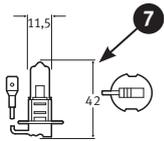
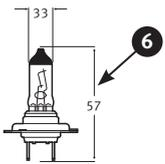
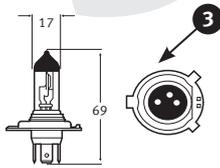
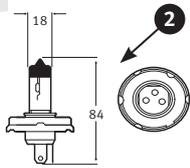
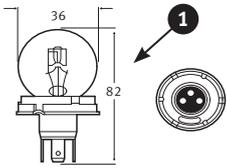

- a)
- b)

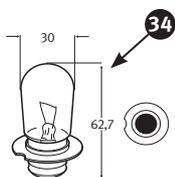
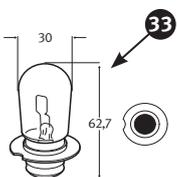
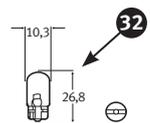
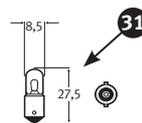
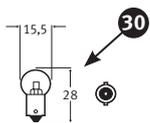
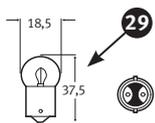
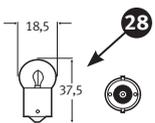

No	Part No	Description	Qty	Notes
31	3965	Bulb 4 watt, BA9s bayonet base	0	} Quantity as required Side lamps
32	202445	Bulb 5 watt, capless base W2, 1x9.5d	0	
33	317711	Bulb 48 watt, P36S British pre-focus base	0	} Quantity as required Spot lamps
34	209894	Bulb 48 watt, P36S British pre-focus base	0	
35	347129	Bilux bulb kit contains 6 bulbs	0	} Quantity as required Vehicles with Bilux headlamps
36	312973	Halogen bulb kit contains 6 bulbs and 2 blade fuses	0	

Circuit testing lamp

brass plated
Part no. 479867

nickel plated
Part no. 479868



Multimeter

digital multimeter with a rotary switch for selection of the 24 different functions and ranges. Suitable for the measurement of DC volts and amps, resistance, dwell, rpm on 4, 6, 8 and 12-cylinder engines. The testing of diodes is also supported. The shock resistant housing is made of rubber. Supplied with 2 sets of cables: one pair with crocodile clamps and one pair with probes. A 9 V block battery and vinyl storage bag is included
Part no. 314833



15.1

Chassis and body panels

Chassis frame and body mountings - TR2 to TR3B

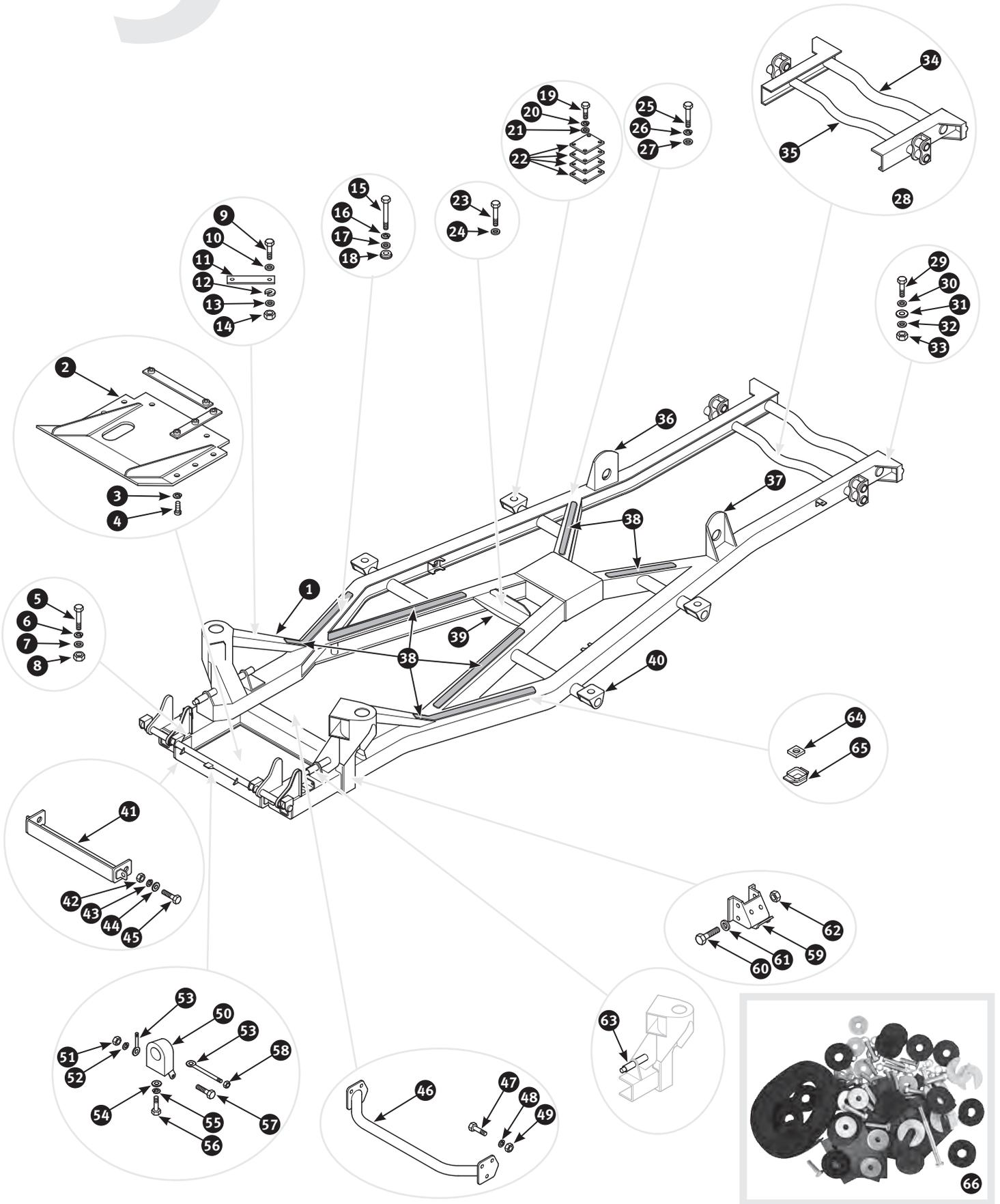

No	Part No	Description	Qty	Notes
1	220749	Chassis frame	1	
2	19313	Stoneguard oil sump - rally and road	1	
3	212192	Spring washer	8	
4	3120	Pointed screw	8	
5	2826	Screw chassis to front body section	2	
6	4961	Plain washer	2	
7	410	Packing thin	4	
8	2303	Nut	2	
9	213888	Screw body to strut	4	
10	2051	Spring washer	4	
11	20941	Plate inner front wing mounting	2	
12	410	Packing thin	8	
13	3887	Plate washer	4	
14	420	Packing thick	4	
15	315905	Bolt floor panel (front section) to chassis	2	
16	212194	Spring washer	2	
17	4961	Plain washer	2	
18	410	Packing thin	4	
19	7896	Screw chassis to middle body section	16	
20	212194	Spring washer	16	
21	4961	Plain washer	16	
22	423	Packing square	16	
23	7898	Screw crossmember to chassis	4	
24	2051	Spring washer	2	
25	213888	Screw floor panel (rear section) to chassis	2	
26	21151	Cup washer	2	
27	3887	Plate washer	2	
28	478840	Rear chassis extension - repair section	1	
29	2826	Screw chassis to rear body section	2	
30	4961	Plain washer	2	
31	410	Packing thin	2	
32	212194	Spring washer	2	
33	2303	Nut	2	
34	14938	Crossmember connecting rear main chassis rails	1	
35	10934	Crossmember rear spring hangers	1	
36	300653	Bracket RH rear shock absorber to chassis	1	
37	300654	Bracket LH rear shock absorber to chassis	1	
38	18054	Everseal strip between chassis and body	0	Quantity as required, supplied per metre
39	20838	Mounting plate gearbox	1	
40	10872	Chassis outrigger	4	
41	216229	Stoneguard radiator	1	
42	3073	Nut	2	
43	2051	Spring washer	2	
44	9671	Plain washer	2	
45	5330	Bolt	2	TR2 and TR3
45	6540	Bolt	2	TR3A and TR3B
46	17966	Brace tube	1	
47	213886	Screw	6	
48	2051	Spring washer	6	
49	3073	Nut	6	

15.1

Chassis and body panels

Chassis frame and body mountings - TR2 to TR3B

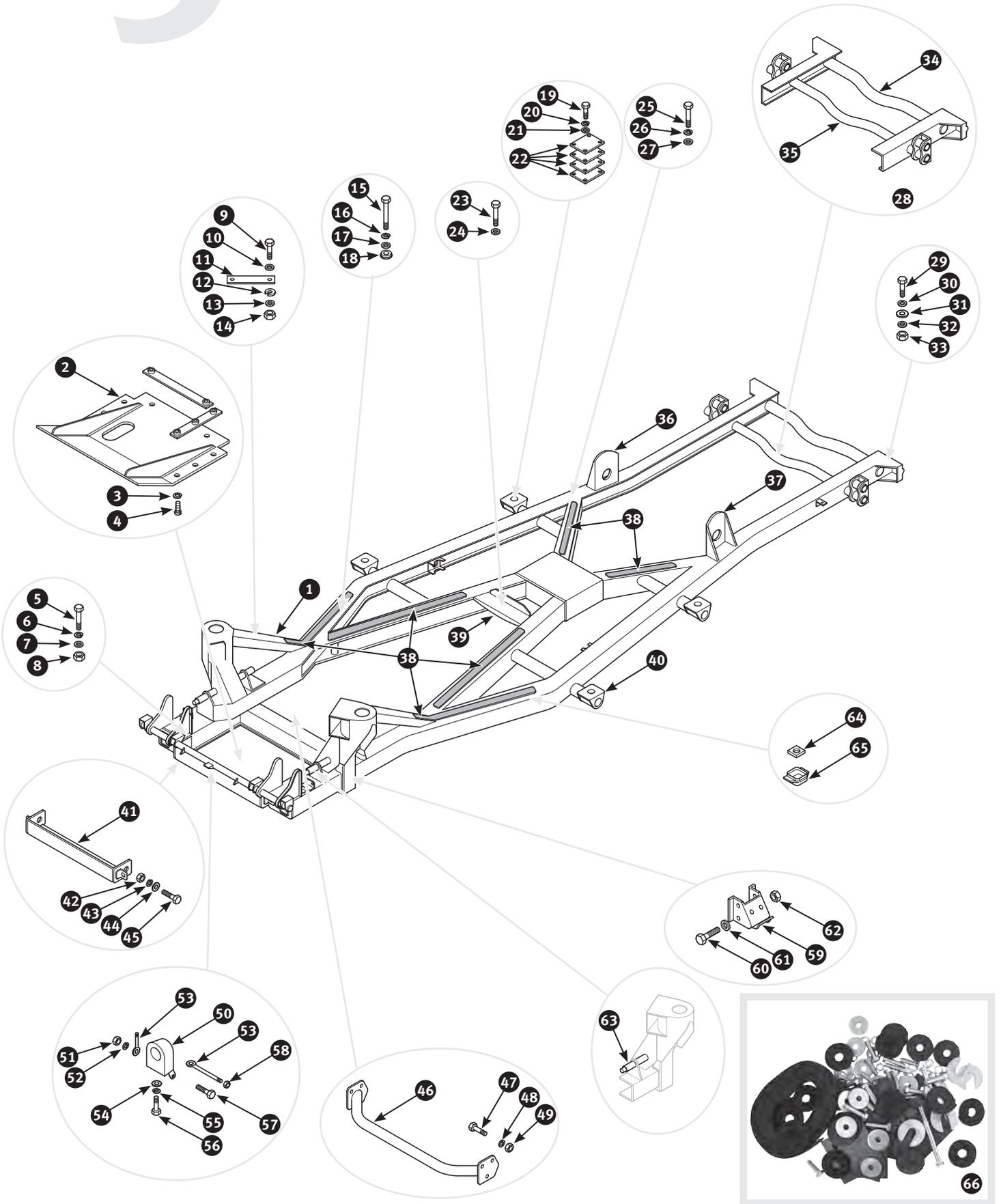

No	Part No	Description	Qty	Notes
50	18119	Guide starter handle	1	
51	2303	Nut	1	
52	212194	Spring washer	1	
53	20942	Stay starter handle guide	2	
54	7794	Plain washer	1	
55	212192	Spring washer	1	
56	3120	Pointed screw	1	
57	4939	Bolt stay to starter handle guide.	1	
58	7739	Nut stay to front chassis cross tube	4	
59	324124	Bracket front suspension rebound.	2	
60	6533	Bolt	4	
61	212194	Spring washer	4	
62	2303	Nut	4	
63	2349	Fulcrum pin lower wishbone.	4	Front suspension
64	9662	Square nut floor panel (front section) to chassis.	2	
65	10630	Cage for square nut.	2	
66	21446	Mounting kit body to chassis	1	Complete car set



Primer

Quickly drying single-component epoxy ester for metal surfaces as very abrasionproof and heat-resistant coating for surfaces subject to wear and tear. Use in construction of machinery and if besides mechanical resistance temperatur resistance up to + 250° C is also demand. Useful too for restauration of car bodys, boats and many more applications. 1 part-epoxy-primer, 1 kg can
 Part no.. 16798

15.2

Chassis and body panels

Chassis frame and body mountings - TR4

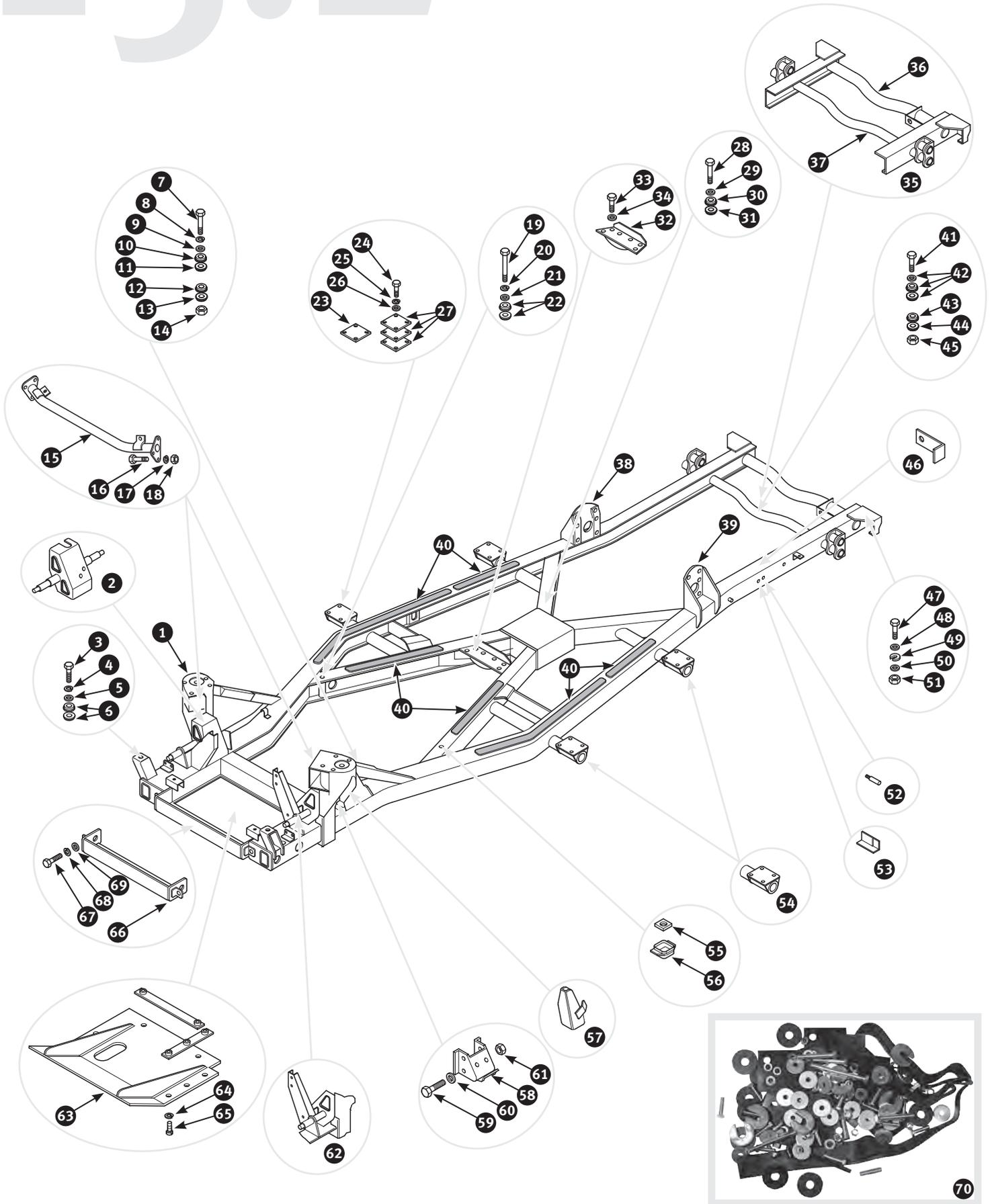

15.2

No	Part No	Description	Qty	Notes
1	287091	Chassis frame	1	
2	300193	Bracket LH engine mounting.	1	Including fulcrum pins
2	20850	Bracket RH engine mounting	1	
3	2826	Screw front inner wing to chassis	2	
4	212194	Spring washer	2	
5	4961	Plain washer	2	
6	410	Packing thin	4	
7	10675	Screw front inner wing to brace member	2	
8	9671	Plain washer	2	
9	410	Packing thin	2	
10	3887	Plate washer	2	
11	420	Packing thick	2	
12	212195	Plain washer	2	
13	2051	Spring washer	2	
14	2303	Nut	2	
15	212005	Brace tube	1	
16	213886	Screw	6	
17	2051	Spring washer	6	
18	3073	Nut	4	
19	212037	Bolt floor panel (front section) to chassis	2	
20	212194	Spring washer	2	
21	4961	Plain washer	2	
22	410	Packing thin	4	
23	2225	Packing plate on front chassis outrigger	4	
24	7896	Screw	16	
25	212194	Spring washer	16	
26	4961	Plain washer	16	
27	423	Packing square	12	
28	7897	Screw floor panel (rear section) to chassis.	2	
29	212194	Spring washer	2	
30	4961	Plain washer	2	
31	3887	Plate washer	2	
32	20838	Mounting plate gearbox	1	
33	7898	Screw	4	
34	2051	Spring washer	4	
35	478840	Rear chassis extension - repair section	1	
36	14938	Crossmember connecting rear main chassis rails.	1	
37	10934	Crossmember rear spring hangers	1	
38	300653	Bracket RH rear shock absorber to chassis.	1	
39	300654	Bracket LH rear shock absorber to chassis.	1	
40	18054	Everseal strip between chassis and body.	0	Quantity as required, supplied per metre
41	6527	Bolt boot floor to chassis.	1	
42	410	Packing thin	3	
43	212193	Plain washer	1	
44	212194	Spring washer	1	
45	2303	Nut	1	
46	20840	Bracket exhaust system to chassis	1	Side fixing below rear axle
47	7896	Screw body to rear extension	2	
48	4961	Plain washer	2	
49	3887	Plate washer	2	

15.2

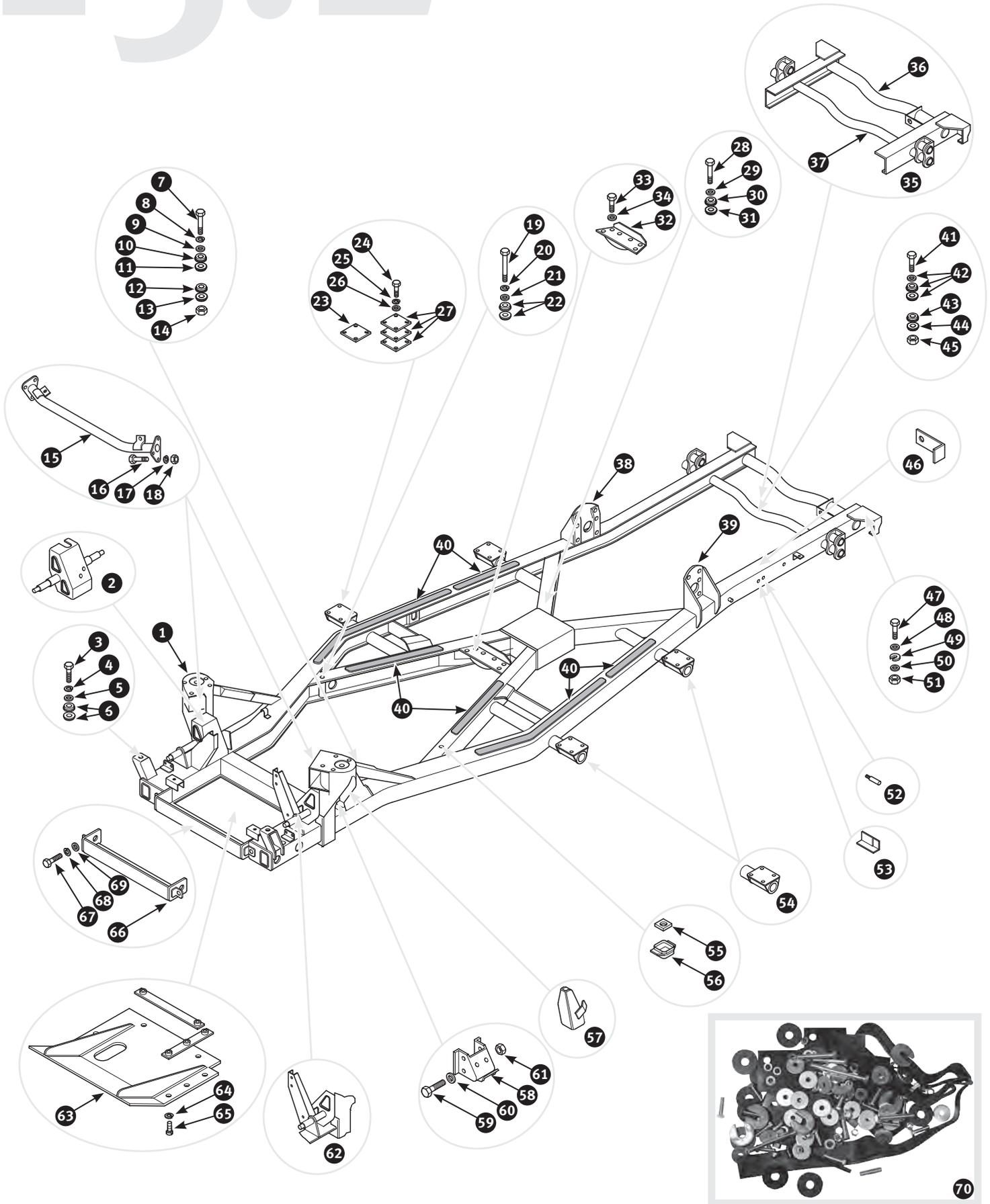

No	Part No	Description	Qty	Notes
50	4961	Plain washer	2	
51	7455	Nyloc nut	2	
52	9917	Anchor bolt axle check strap to chassis	4	TR4 to CT23382 TR4 from CT23383
53	20849	Bracket axle check strap	4	
54	10872	Chassis outrigger	4	
55	9662	Square nut floor panel (front section) to chassis	2	
56	10630	Cage for square nut	2	
57	300194	Bracket bump stop for LH wishbone arm	1	
57	20851	Bracket bump stop for RH wishbone arm	1	
58	324124	Bracket front suspension rebound	2	
59	6533	Bolt	2	
60	212194	Spring washer	2	
61	2303	Nut	2	
62	2349	Fulcrum pin lower wishbone	4	Front suspension
63	19313	Stoneguard oil sump - rally and road	1	
64	212192	Spring washer	8	
65	3120	Pointed screw	8	
66	19312	Stoneguard radiator	1	
67	213886	Screw	2	
68	2051	Spring washer	2	
69	212195	Plain washer	2	
70	21447	Mounting kit body to chassis	1	Complete car set



Chassis frame paint
 black, 500 ml can
 Part no.21800
 black, 400 ml aerosol
 Part no.22615

15.3

Chassis and body panels

Chassis frame and body mountings - TR4A with solid rear axle

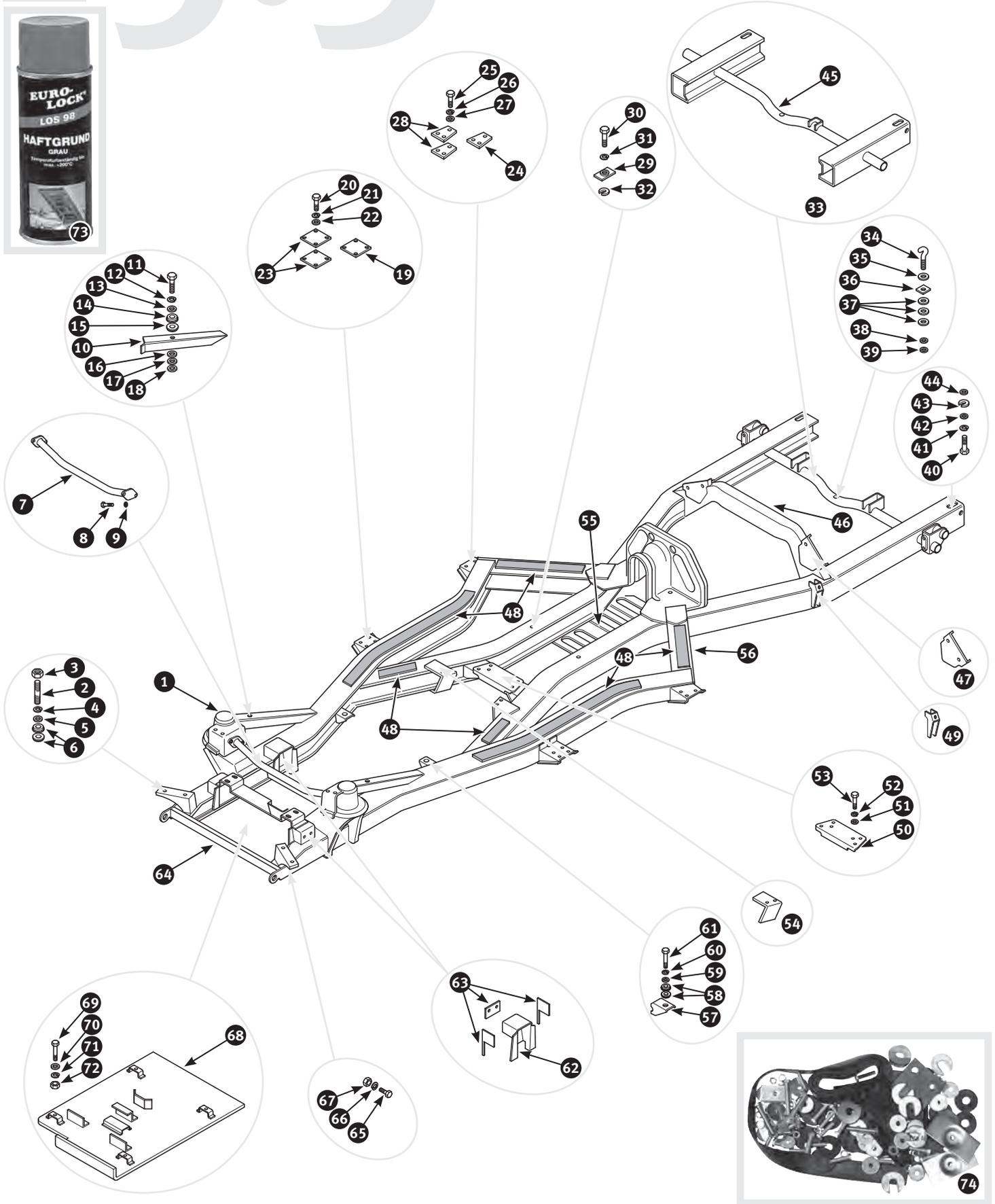

No	Part No	Description	Qty	Notes
1	378868	Chassis frame	1	
2	9764	Stud front inner wing to chassis	2	
3	3073	Nut	2	
4	2051	Spring washer	2	
5	212195	Plain washer	2	
6	410	Packing thin	4	
7	346975	Brace tube	1	
8	213887	Screw	4	
9	2051	Spring washer	4	
10	317543	Support rail chassis to spring pan	2	
11	10675	Screw	2	
12	11672	Plain washer	2	
13	410	Packing thin	2	
14	3887	Plate washer	2	
15	420	Packing thick	2	
16	212195	Plain washer	2	
17	2051	Spring washer	2	
18	3073	Nut	2	
19	2225	Packing plate ,A' post to front chassis outrigger	0	Quantity as required
20	7897	Screw	8	
21	212194	Spring washer	8	
22	4961	Plain washer	8	
23	423	Packing square	4	
24	16441	Packing plate ,B' post to rear chassis outrigger	0	Quantity as required
25	7897	Screw	6	
26	212194	Spring washer	6	
27	4961	Plain washer	6	
28	1251	Packing	4	
29	3329	Packing plate	2	
30	10675	Screw	2	
31	212194	Spring washer	2	
32	3887	Plate washer	2	
33	25100	Rear chassis extension - repair section	1	
34	1234	Hook spare wheel retaining	1	
35	2303	Nut	1	
36	9634	Mounting plate for spare wheel hook	1	
37	410	Packing thin	3	
38	212193	Plain washer	1	
39	2049	Nyloc nut	1	
40	7896	Screw body to rear extension	2	
41	212194	Spring washer	2	
42	4961	Plain washer	1	
43	3887	Plate washer	2	
44	10488	Plain washer	2	
45	14938	Crossmember connecting rear main chassis rails	1	
46	18090	Crossmember with rear shock absorber locating plates	1	
47	295	Locating plate rear shock absorber to chassis	2	
48	18054	Everseal strip between chassis and body	0	Quantity as required, Supplied per metre
49	281	Bracket rear axle rebound, LH side	1	
49	300688	Bracket rear axle rebound, RH side	1	
50	325389	Mounting plate gearbox to chassis	1	
51	3073	Nut	4	
52	2051	Spring washer	4	
53	7898	Screw	4	
54	277	Bracket body to chassis, LH side	1	
54	300687	Bracket body to chassis, RH side	1	
55	10936	Stiffener plate chassis	1	
56	10935	Chassis outrigger to rear trailing arm	2	
57	280	Bracket footwell area to chassis	2	
58	410	Packing thin	4	

15.3

Chassis and body panels

Chassis frame and body mountings - TR4A with solid rear axle

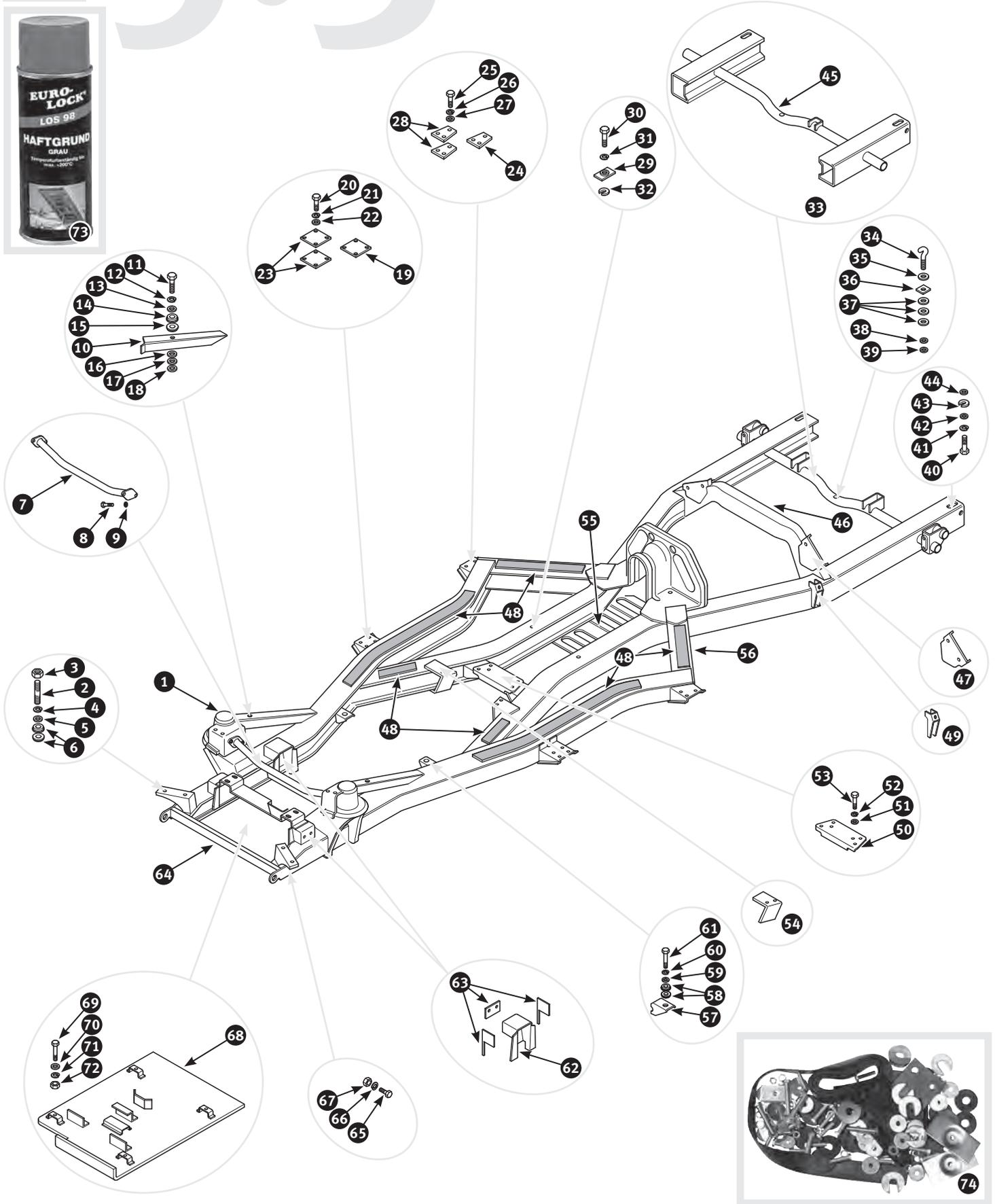

No	Part No	Description	Qty	Notes
59	4961	Plain washer	2	
60	212194	Spring washer	2	
61	7897	Screw	2	
62	3634	Bracket wishbone arm to chassis	4	
63	12706	Reinforcement LH wishbone arm bracket	2	Supplied in sets of 3
63	12707	Reinforcement RH wishbone arm bracket	2	
64	3019	Radiator guard	1	
65	213887	Screw radiator guard to chassis	4	
66	2051	Spring washer	4	
67	3073	Nut	4	
68	19541	Stoneguard oil sump - rally and road	1	
69	213886	Screw	4	
70	212195	Plain washer	4	
71	2051	Spring washer	4	
72	3073	Nut	4	
73	464948	Primer red oxide, 400 ml aerosol	1	
73	464946	Primer grey, 400 ml aerosol	1	
74	1344	Mounting kit body to chassis	1	Complete car set

Mike Sanders Body cavity grease

Provides cavity protection and under-sealing for blank, corroded and painted surfaces. This is the only product (according to independent tests) that provides long term seam penetration and also protects better than its competitors. It is suited to all types of vehicles, vintage and classic, new and used of all ages. It does not have to be applied by a garage, it can be applied by a 'do-it-yourself' enthusiast with the right equipment. This is 100% product i.e. it contains no solvents which results in no lasting odours in the vehicle and therefore safe for the occupants. Mike Sanders Anti-corrosion-grease has been tested by several independent German car magazines. It is the best rust prevention grease on the market.

750 g can

Part no.288465

4 kg canister

Part no.436995



15.4

Chassis and body panels

Chassis frame and body mountings - TR4A IRS

Cars with independent rear suspension

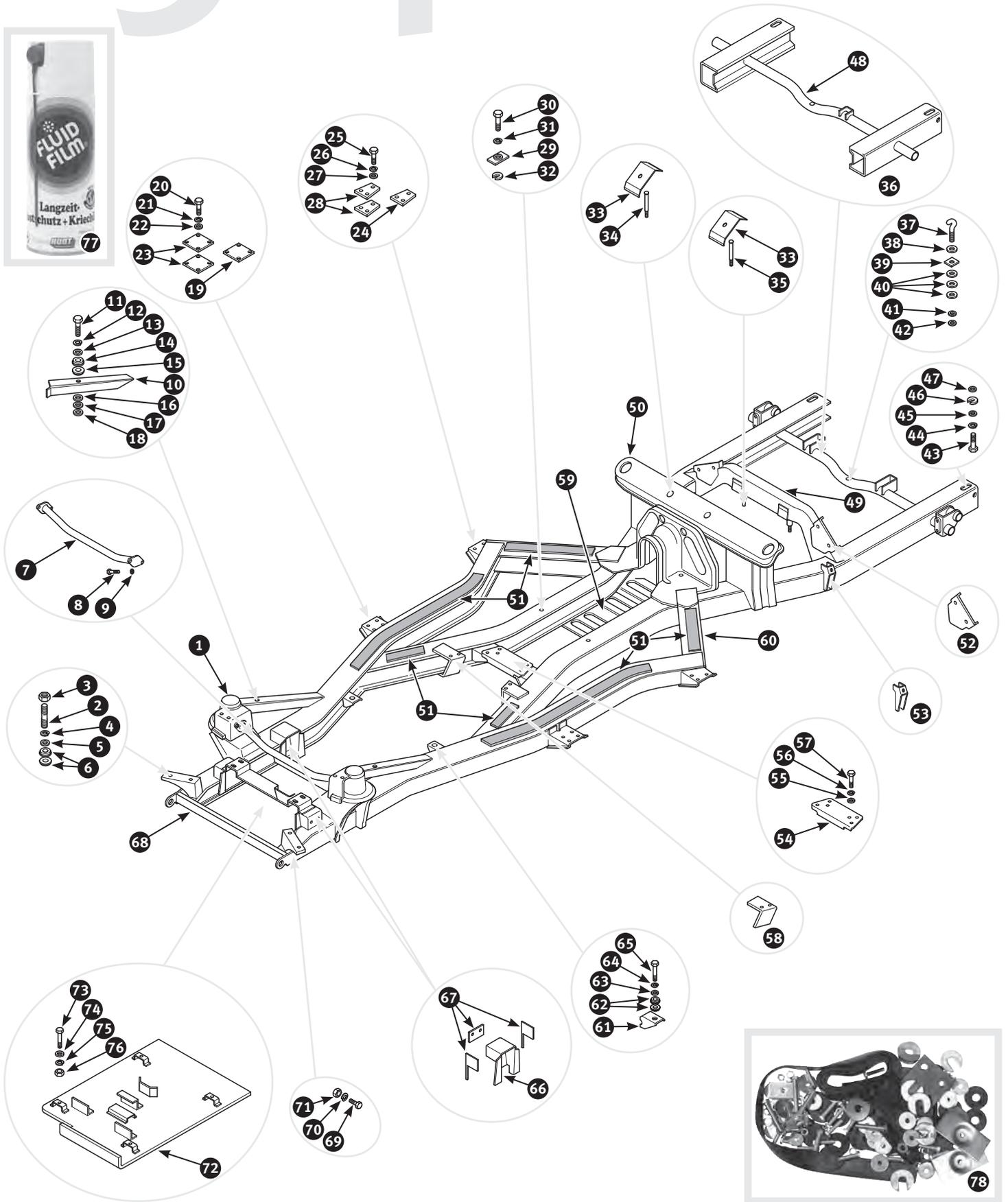

No	Part No	Description	Qty	Notes
1	19943	Chassis frame	1	
2	9764	Stud front inner wing to chassis	2	
3	3073	Nut	2	
4	2051	Spring washer	2	
5	212195	Plain washer	2	
6	410	Packing thin	4	
7	346975	Brace tube	1	
8	213887	Screw	4	
9	2051	Spring washer	4	
10	317543	Support rail chassis to spring pan	2	
11	10675	Screw	2	
12	11672	Plain washer	2	
13	410	Packing thin	2	
14	3887	Plate washer	2	
15	420	Packing thick	2	
16	212195	Plain washer	2	
17	2051	Spring washer	2	
18	3073	Nut	2	
19	2225	Packing plate ,A' post to front chassis outrigger	0	Quantity as required
20	7897	Screw	8	
21	212194	Spring washer	8	
22	4961	Plain washer	8	
23	423	Packing square	4	
24	16441	Packing plate ,B' post to rear chassis outrigger	0	Quantity as required
25	7897	Screw	6	
26	212194	Spring washer	6	
27	4961	Plain washer	6	
28	1251	Packing	4	
29	3329	Packing plate	2	
30	10675	Screw	2	
31	212194	Spring washer	2	
32	3887	Plate washer	2	
33	316045	Reinforcement front and rear differential mounting bolt	2	
34	1712	Anchor bolt front differential mounting	2	
35	9917	Anchor bolt rear differential mounting	2	
36	25100	Rear chassis extension - repair section	1	
37	1234	Hook spare wheel retaining	1	
38	2303	Nut	1	
39	9634	Mounting plate for spare wheel hook	1	
40	410	Packing thin	3	
41	212193	Plain washer	1	
42	2049	Nyloc nut	1	
43	7896	Screw body to rear extension	2	
44	212194	Spring washer	2	
45	4961	Plain washer	1	
46	3887	Plate washer	2	
47	10488	Plain washer	2	
48	14938	Crossmember connecting rear main chassis rails	1	
49	18090	Crossmember rear differential mounting	1	
50	18091	Crossmember front differential mounting	1	
51	18054	Everseal strip between chassis and body	0	Quantity as required, Supplied per metre
52	295	Locating plate rear shock absorber to chassis	2	
53	281	Bracket rear axle rebound, LH side	1	
53	300688	Bracket rear axle rebound, RH side	1	
54	325389	Mounting plate gearbox to chassis	1	
55	3073	Nut	4	
56	2051	Spring washer	4	
57	7898	Screw	4	
58	277	Bracket body to chassis, LH side	1	
58	300687	Bracket body to chassis, RH side	1	

15.4

Chassis and body panels

Chassis frame and body mountings - TR4A IRS

Cars with independent rear suspension

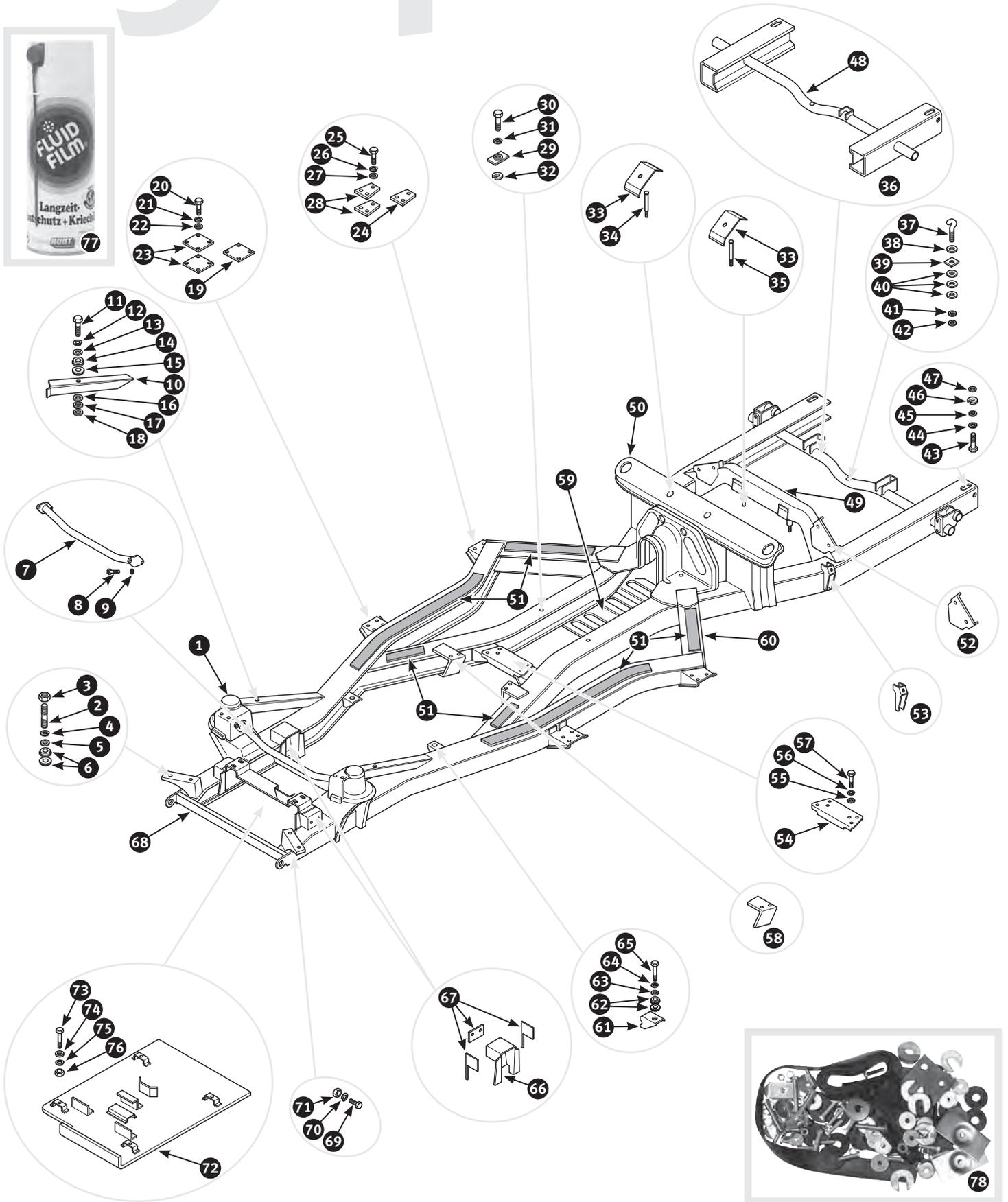

No	Part No	Description	Qty	Notes
59	10936	Stiffener plate chassis	1	
60	10935	Chassis outrigger to rear trailing arm.	2	
61	280	Bracket footwell area to chassis	2	
62	410	Packing thin	4	
63	4961	Plain washer	2	
64	212194	Spring washer	2	
65	7897	Screw	2	
66	3634	Bracket wishbone arm to chassis	4	
67	12706	Reinforcement LH wishbone arm bracket	2	} Supplied in sets of 3
67	12707	Reinforcement RH wishbone arm bracket	2	
68	3019	Radiator guard	1	
69	213887	Screw radiator guard to chassis	4	
70	2051	Spring washer	4	
71	3073	Nut	4	
72	19541	Stoneguard oil sump - rally and road	1	
73	213886	Screw	4	
74	212195	Plain washer	4	
75	2051	Spring washer	4	
76	3073	Nut	4	
77	216710	Fluid Film Rust-preventive 400 ml aerosol	1	} Made of Lanolin purified from sheep wool grease, FCKW free
78	1344	Mounting kit body to chassis	1	} Complete car set



Panel-Beating Kit

supplied in a 7 piece set. Contains 4 dollies and 3 hammers, drop-forged with nylon shaft and rubber handles or hickory handlesPart no. 366601
 nylon shaftPart no. 215721

15.5

Chassis and body panels | Wings, doors and bonnets - TR2 to TR3B

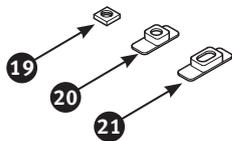
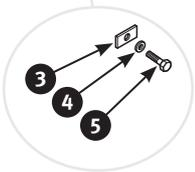
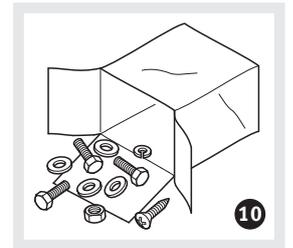
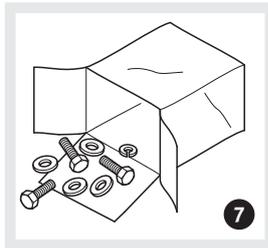
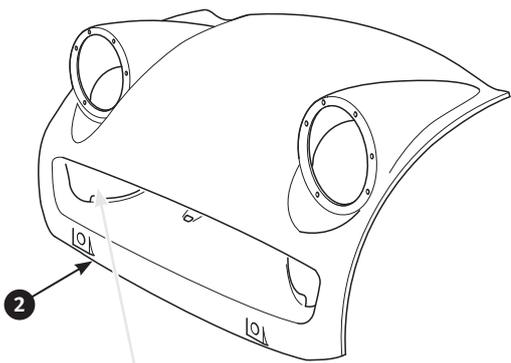
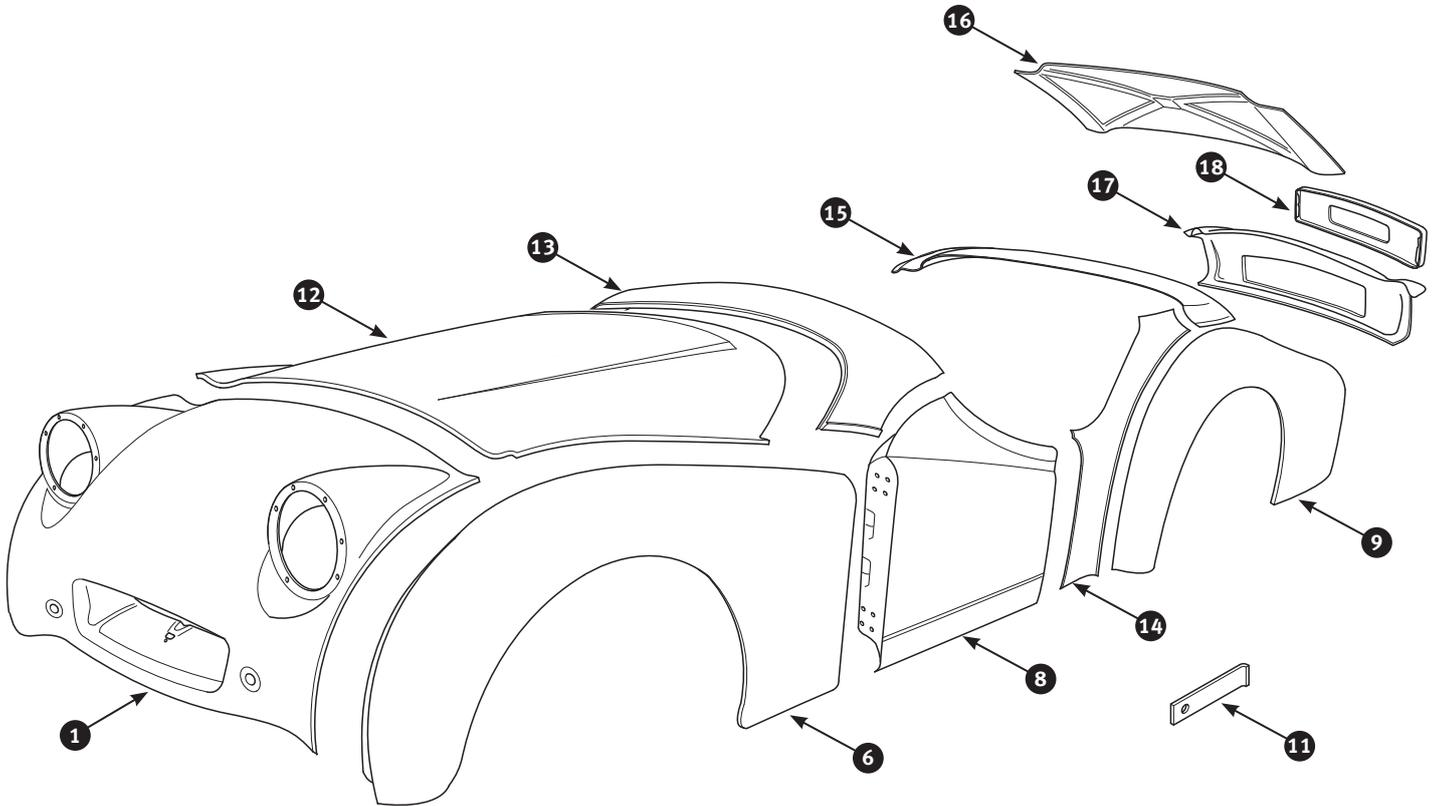

No	Part No	Description	Qty	Notes
1	11553	Front shroud mild steel	1	TR2 and TR3
1	11554	Front shroud aluminium	1	
2	9863	Front shroud mild steel	1	TR3A and TR3B
2	11555	Front shroud aluminium	1	
3	14958	Spire nut	4	
4	2831	Plain washer	4	
5	2717	Screw	4	
6	531	Wing LH front, mild steel	1	
6	324516	Wing LH front, aluminium	1	
6	532	Wing RH front, mild steel	1	
6	324517	Wing RH front, aluminium	1	
7	2564	Fitting kit front wing	2	
8	290288	Door LH	1	TR2 to TS4001 - main identifiers: long doors (to wing bottoms) without external handles, no outer sills fitted
8	214419	Door RH	1	
8	213970	Door LH	1	TR2 from TS4002, TR3 - main identifiers: short doors (to top of outer sill) without external handles, outer sills fitted
8	213969	Door RH	1	
8	214438	Door LH	1	TR3A to TS60000 - main identifiers: wooden top rail and external handles
8	203852	Door RH	1	
8	214443	Door LH	1	TR3A from TS60001, TR3B - main identifiers: metal top rail and external handles
8	214444	Door RH	1	
9	181	Wing LH rear, mild steel	1	
9	324518	Wing LH rear, aluminium	1	
9	182	Wing RH rear, mild steel	1	
9	324519	Wing RH rear, aluminium	1	
10	2563	Fitting kit rear wing	2	
11	19160	Clamp rear wing retaining	2	
12	293651	Bonnet new item, aluminium	1	TR2 to TS4228: main identifiers: 4 rear slats
12	293652	Bonnet new item, mild steel	1	
12	319141	Bonnet new item, mild steel	1	TR2 from TS4229, TR3, TR3A to TS60000: main identifiers: 2 rear slats and holes to accept Dzus fasteners
12	293653	Bonnet used item, mild steel	1	
12	293650	Bonnet new item, mild steel	1	TR3A from TS60001: main identifiers: 2 rear slats, holes to accept Dzus fasteners and raised rear position to accept hinges
12	316903	Bonnet used item, mild steel	1	
13	487010	Scuttle panel without vent lid hole	1	TR2 to TS6156
13	487011	Scuttle panel with vent lid hole	1	TR2 from TS6157, TR3, TR3A and TR3B
14	179	Closing panel ,B' post to LH rear wing	1	
14	180	Closing panel ,B' post to RH rear wing	1	
15	2562	Decking panel tonneau saddle	1	TR2 and TR3, TR3A to TS60000 TR3A from TS60001, TR3B
15	2555	Decking panel tonneau saddle	1	
16	214423	Boot lid mild steel	1	TR2 and TR3
16	11548	Boot lid aluminium	1	
16	3754	Boot lid mild steel	1	TR3A to TS60000
16	11547	Boot lid aluminium	1	
16	3755	Boot lid mild steel	1	TR3A from TS60001, TR3B
16	487012	Boot lid aluminium	1	
17	529	Rear valance	1	TR2, TR3 to TS18912
17	185	Rear valance	1	TR3 from TS18913, TR3A and TR3B
18	530	Door spare wheel compartment	1	
19	10629	Square nut	0	Quantity as required
20	10630	Cage for square nut - round hole type	0	
21	13377	Cage for square nut - elongated hole type	0	
22	206509	Zinc spray 400 ml aerosol	1	Ask for our special catalogue.

15.6

Chassis and body panels

Outer body repair panels - TR2 to TR3B

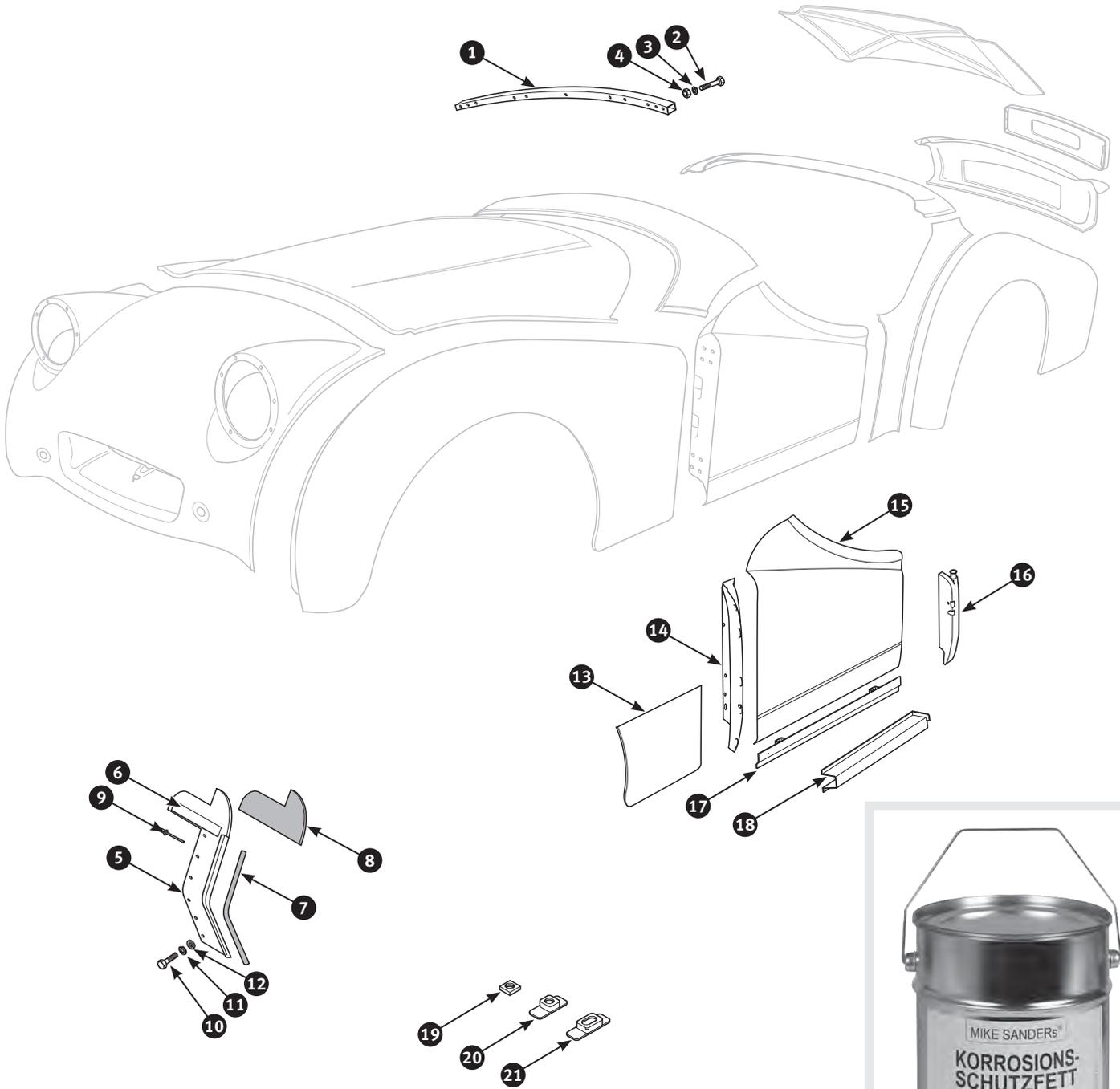

22

No	Part No	Description	Qty	Notes
1	251259	Cross brace - new item	1	Behind front shroud
1	213043	Cross brace - used item	1	
2	4835	Screw cross brace to front shroud	8	
2	3171	Bolt cross brace to inner front wing	4	
3	209089	Shakeproof washer	12	
4	2828	Nut	12	
5	2559	Splash shield in front wing - mild steel	2	Alternatives
5	347700	Splash shield in front wing - stainless steel	2	
6	20982	Metal plate splash shield	2	
7	446	Sealing rubber splash shield side	2	
8	1776	Sealing rubber splash shield top	2	
9	20983	Pop rivet to seal to splash shield	8	
10	3120	Pointed screw splash shield to bulkhead	10	
11	212192	Spring washer	10	
12	7794	Plain washer	10	
13	19610	Repair panel LH front wing	1	
13	19611	Repair panel RH front wing	1	
14	142	,A' post LH	1	
14	143	,A' post RH	1	
15	13717	Door skin LH	1	TR2 to TS4001 - main identifiers: long doors (to wing bottoms) without external handles, no outer sills fitted
15	13721	Door skin RH	1	
15	12085	Door skin LH	1	TR2 from TS4002, TR3 - main identifiers: short doors (to top of outer sill) without external handles, outer sills fitted
15	12086	Door skin RH	1	
15	12097	Door skin LH	1	TR3A and TR3B - main identifiers: external handles
15	12273	Door skin RH	1	
16	508	,B' post LH	1	
16	509	,B' post RH	1	
17	173	Inner sill LH	1	
17	1245	Inner sill RH	1	
18	183	Outer sill LH	1	TR2 from TS4002, TR3, TR3A und TR3B
18	184	Outer sill RH	1	
19	10629	Square nut	0	
20	10630	Cage for square nut - round hole type	0	Quantity as required
21	13377	Cage for square nut - elongated hole type	0	
22	436995	Mike Sanders Body cavity grease 4 kg canister	1	Ask for our special catalogue.



Nibbler

250 mm long, cuts sheet metal up to 1.2 mm without bending or distortion. Comes with exchangeable spare blade
Part no. 320618

Spare blade

Part no. 343096

15.7

Chassis and body panels

Inner body repair panels, front section - TR2 to TR3B

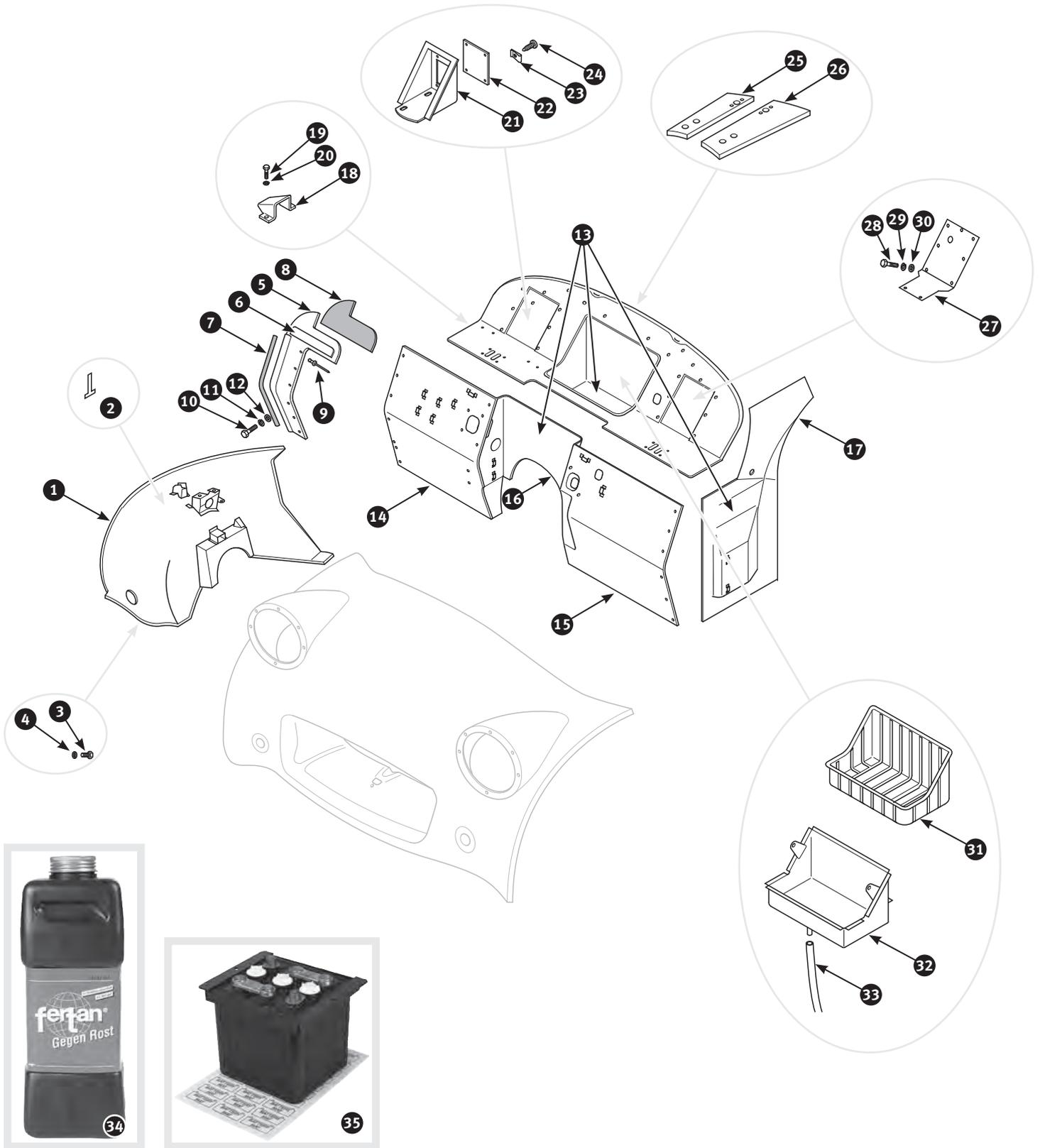

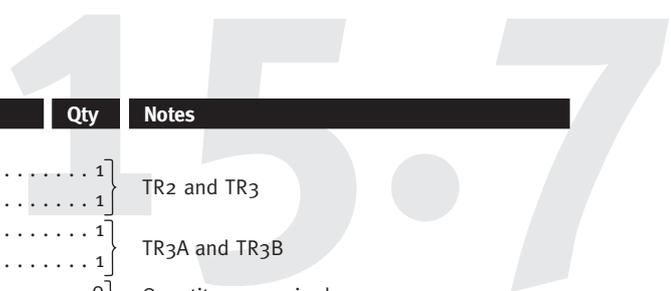

No	Part No	Description	Qty	Notes
1	11550	Inner wing LH front	1	TR2 and TR3
1	11551	Inner wing RH front	1	
1	16945	Inner wing LH front	1	TR3A and TR3B
1	16946	Inner wing RH front	1	
2	10440	Support bracket wiring loom securing	0	Quantity as required For welding to front inner wing
3	3120	Pointed screw wing to inner wing	22	
4	7794	Plain washer	22	
5	2559	Splash shield in front wing - mild steel	2	Alternatives
5	347700	Splash shield in front wing - stainless steel	2	
6	20982	Metal plate splash shield	2	
7	446	Sealing rubber splash shield side	2	
8	1776	Sealing rubber splash shield top	2	
9	20983	Pop rivet to seal to splash shield	8	
10	3120	Pointed screw splash shield to bulkhead	10	
11	212192	Spring washer	10	
12	7794	Plain washer	10	
13	16947	Bulkhead assembly	1	TR2 and TR3, TR3A to TS60000
13	312980	Bulkhead assembly	1	TR3A from TS60001, TR3B
14	293796	Repair panel bulkhead - RH front section	1	
15	299306	Repair panel bulkhead - LH front section	1	
16	307201	Repair panel bulkhead - centre section	1	
17	301291	Repair panel bulkhead - RH side section	1	
17	307138	Repair panel bulkhead - LH side section	1	
18	310989	Bracket wiper motor	1	TR2, TR3 to TS12567
18	337591	Bracket wiper motor - new item	1	TR3 from TS 12568, TR3A and TR3B
18	201164	Bracket wiper motor - used item	1	
19	7884	Screw bracket to bulkhead	3	
20	212192	Spring washer	3	
21	317823	Support panel master cylinder	1	
22	21426	Back plate master cylinder support panel	1	
23	9658	Spire nut	4	
24	3819	Self tapping screw	4	
25	349165	Stiffener plate scuttle panel, RH	1	
26	352702	Stiffener plate scuttle panel, LH	1	
27	21105	Blanking plate master cylinder pocket	1	
28	3120	Pointed screw	14	
29	212192	Spring washer	14	
30	7794	Plain washer	14	
31	16942	Battery box plastic	1	Alternatives
32	2990	Battery box mild steel	1	
33	2471	Drain tube	1	
34	316823	Fertan Rust converter 1 litre bottle	1	Ask for our special catalogue.
35	343415	Battery mat neutralizes battery acid and protects your vehicle against corrosion	1	Size: 12" x 8"

15.8

Chassis and body panels

Inner body repair panels, rear section - TR2 to TR3B

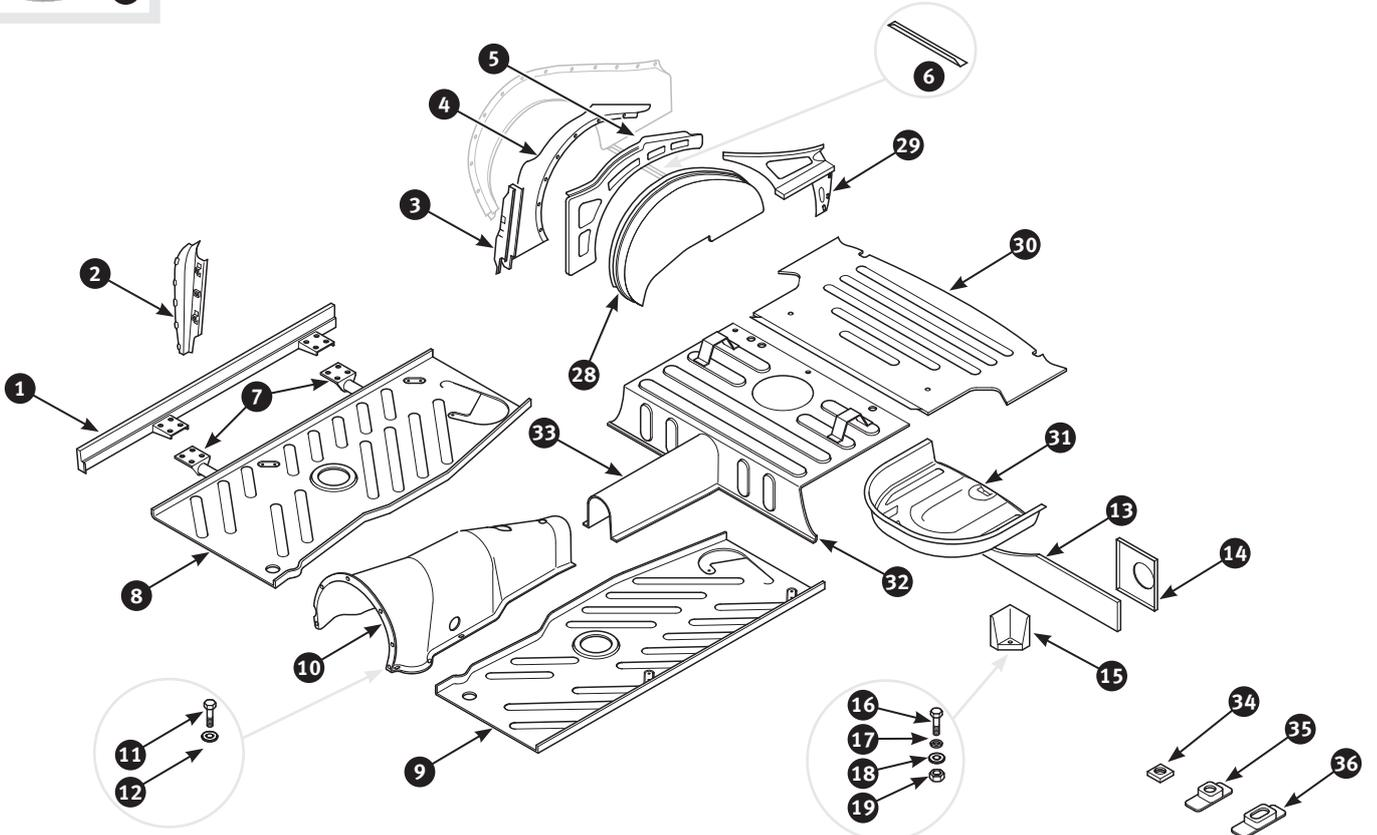
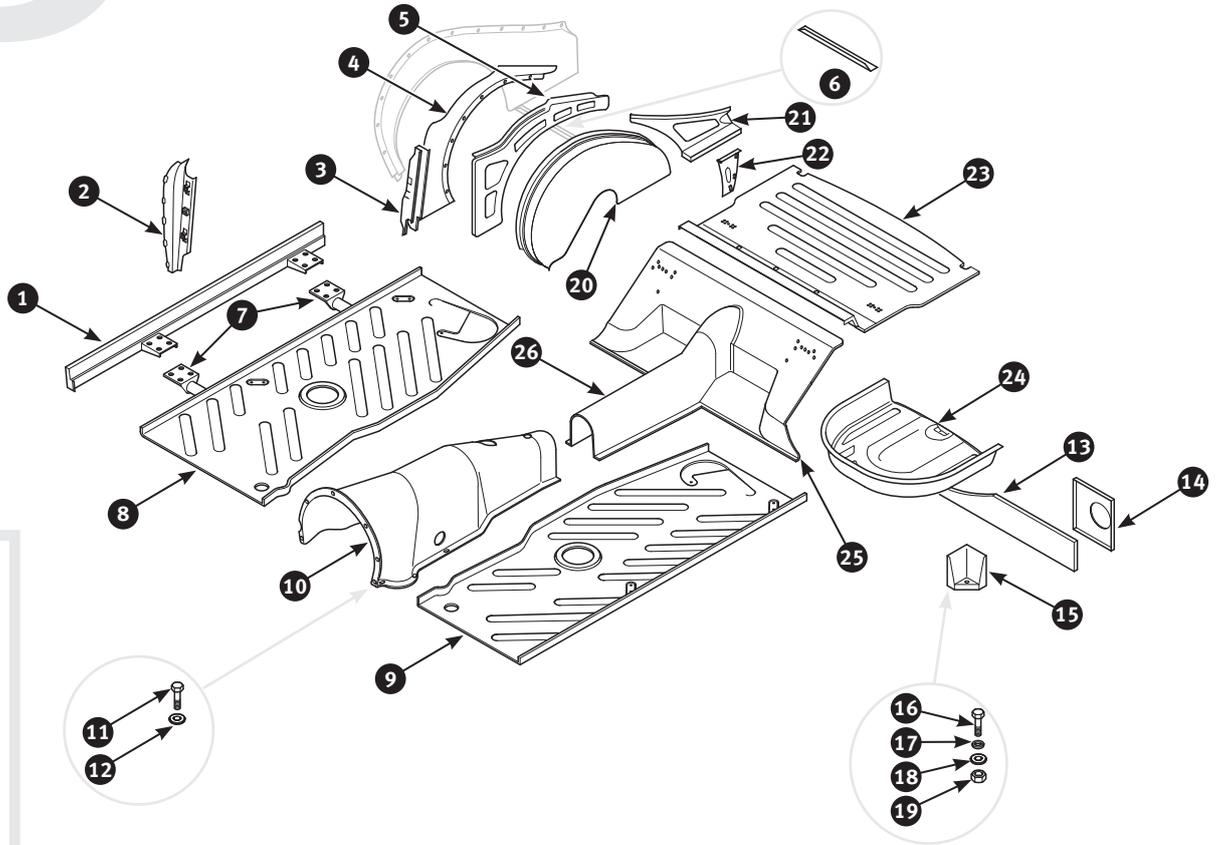

No	Part No	Description	Qty	Notes
1	173	Inner sill LH	1	
1	1245	Inner sill RH	1	
2	142	,A' post LH	1	
2	143	,A' post RH	1	
3	508	,B' post LH	1	
3	509	,B' post RH	1	
4	179	Closing panel ,B' post to LH rear wing	1	
4	180	Closing panel ,B' post to RH rear wing	1	
5	11552	Side panel LH inner	1	
5	11549	Side panel RH inner	1	
6	21158	Stay rear wing to wheel arch	2	
7	10872	Chassis outrigger	4	
8	200987	Floor panel RH	1	
9	200989	Floor panel LH	1	
10	214342	Gearbox tunnel mid steel	1	} Alternatives
10	364876	Gearbox tunnel fibreglass	1	
11	3120	Pointed screw	16	
12	7794	Plain washer	16	
13	523	Reinforcement inner rear bottom	1	
14	524	Closing panel rear bottom - LH inner	1	
14	525	Closing panel rear bottom - RH inner	1	
15	175	Mounting bracket body to chassis, LH	1	
15	178	Mounting bracket body to chassis, RH	1	
16	2826	Screw mounting bracket to chassis	2	
17	10487	Plain washer	2	
18	212194	Spring washer	2	
19	2303	Nut	2	
20	3750	Wheel arch LH rear	1	}
20	3749	Wheel arch RH rear	1	
21	177	Side panel boot, LH	1	} TR2 and TR3, TR3A to TS60000
21	176	Side panel boot, RH	1	
22	11781	Stiffener LH boot side panel	1	
22	11782	Stiffener RH boot side panel	1	
23	174	Boot floor	1	
24	3747	Spare wheel tray	1	
25	528	Floor panel rear	1	
26	371187	Transmission tunnel	1	} Special body protection with resin, overpaintable. It is a resistant barrier for under the floor pans and wheel arches etc. Available in grey and black
27	482512	Underbody coating 1000 ml cartridge, grey	1	
27	389240	Underbody coating 500 ml aerosol, grey	1	
28	3752	Wheel arch LH rear	1	}
28	3751	Wheel arch RH rear	1	
29	214137	Side panel boot, LH	1	} TR3A from TS60001, TR3B
29	214136	Side panel boot, RH	1	
30	20442	Boot floor	1	
31	3748	Spare wheel tray	1	
32	16944	Floor panel rear	1	
33	486935	Transmission tunnel	1	TR3A from TS60001, TR3B
34	10629	Square nut	0	
35	10630	Cage for square nut - round hole type	0	} Quantity as required
36	13377	Cage for square nut - elongated hole type	0	

15.9

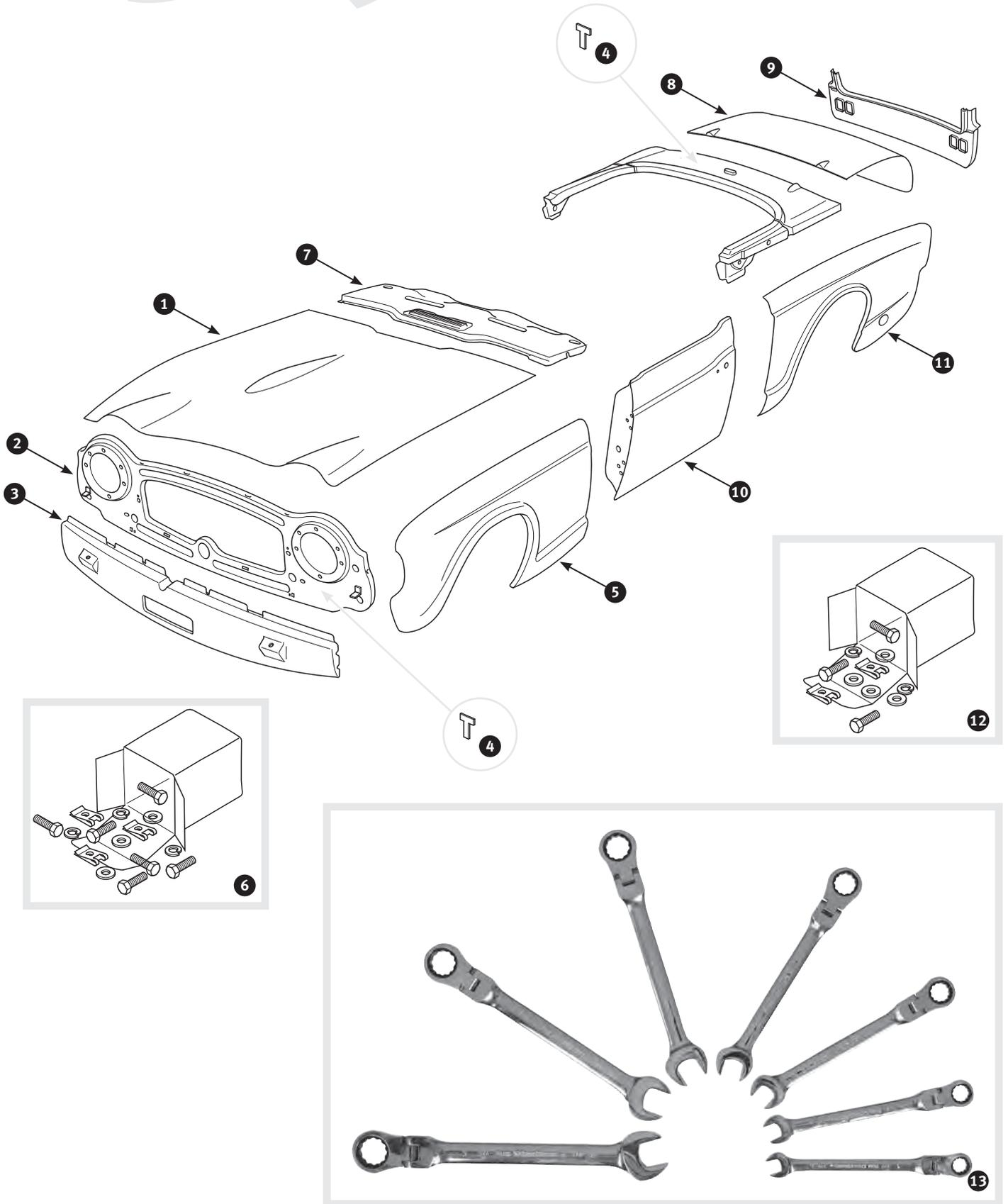

No	Part No	Description	Qty	Notes
1	353253	Bonnet	1	TR4 to CT6429
1	352852	Bonnet	1	
1	300822	Bonnet	1	
2	289934	Front valance - upper	1	TR4
2	12095	Front valance - upper	1	
3	516	Front valance - lower	1	Without oil cooler aperture
3	329561	Front valance - lower	1	With oil cooler aperture
4	10440	Support bracket wiring loom securing	0	Quantity as required
5	548	Wing LH front	1	Mild steel
5	549	Wing RH front	1	
5	19356	Wing LH front	1	Aluminium
5	19357	Wing RH front	1	
6	2580	Fitting kit front wing	2	
7	2326	Scuttle panel	1	
8	2547	Boot lid mild steel	1	
8	485	Boot lid aluminium	1	
9	17712	Rear valance	1	
10	2569	Door LH	1	TR6 variant - to fit these doors to TR4/TR4A models, the 'B' posts and the locking and latching mechanism of the TR6 must be used
10	2570	Door RH	1	
11	521	Wing LH rear	1	Mild steel
11	522	Wing RH rear	1	
11	19355	Wing LH rear	1	Aluminium
11	19354	Wing RH rear	1	
12	2558	Fitting kit rear wing	2	
13	244339	Gear wrench set supplied in a 7 piece set. From 3/8" to 3/4".	1	For further information see chapter 21.30

Fertan NT10 cavity and rust protection

based on the latest nano-technology. NT10 cavity protection material has in comparison with existing materials enormous advantages. The protective layer produced is glossy when dry and resistant to pollutants. Damp, dirt, water and substances dissolved in it (e.g. salt) cannot adhere to the water-repellent surface, and therefore the development of new rust and corrosion is prevented before it can begin. NT10 is permanently resistant and damage from mechanical impacts can simply be repaired. Contains: 625ml cavity protection, 125 ml hardener, 200 ml concentrated metal cleaner and a 0.05 mm bore jet for cavity spray guns.

Part no.246265

4 Catalogues, you must have:

- Oils and lubricants
- Tuning and more
- Accessories
- Tools



Order online: www.Limora.com • www.scparts.co.uk



15.10

Chassis and body panels Outer body repair panels - TR4 and TR4A

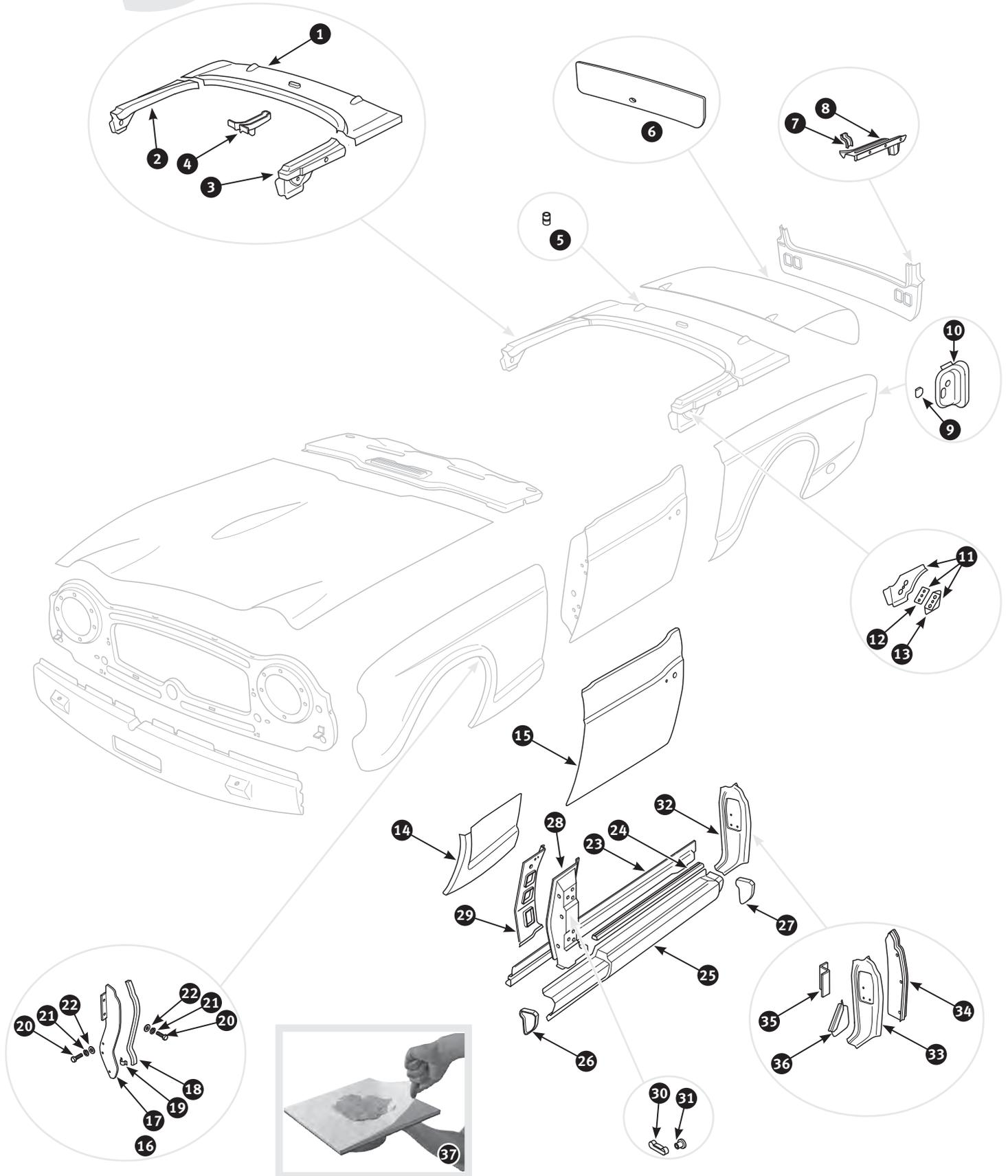

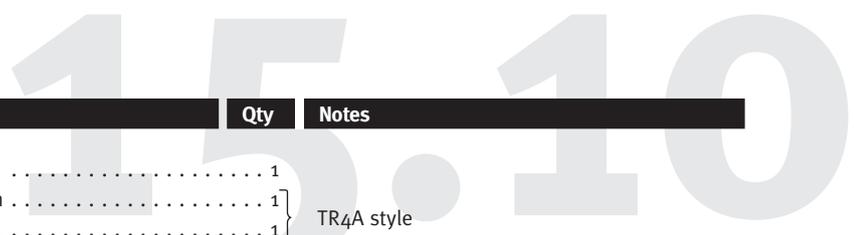

No	Part No	Description	Qty	Notes
1	1372	Decking panel rear, centre section skin	1	
2	153	Decking panel rear, RH forward section	1	TR4A style
3	152	Decking panel rear, LH forward section	1	
4	338270	Reinforcement rear deck centre section	1	
5	25711	Rivet with thread - hood retainer bar to rear deck	5	TR4A
6	315190	Repair panel boot lid	1	
7	300775	Bracket boot lid stay	1	
8	506	Decking panel boot area, LH section	1	
8	507	Decking panel boot area, RH section	1	
9	517	Housing LH rear lamp	1	
9	518	Housing RH rear lamp	1	
10	11835	Retaining clip rear wing to lamp housing	2	
11	300801	Stiffener LH ,B' post	1	With hood frame tapped plate assembly
11	300802	Stiffener RH ,B' post	1	
12	338071	Tapped plate hood frame pivot	2	
13	293507	Retainer plate	2	
14	300422	Repair panel LH front wing	1	
14	334363	Repair panel RH front wing	1	
15	338676	Door skin LH	1	Mild steel
15	338679	Door skin RH	1	
15	336787	Door skin LH	1	Aluminium
15	336788	Door skin RH	1	
16	338217	Splash shield LH - complete kit	1	With fittings and seal assembly
16	338218	Splash shield RH - complete kit	1	
17	474	Splash shield LH	1	
17	475	Splash shield RH	1	
18	446	Sealing rubber splash shield	2	
19	418	Retaining clip sealing rubber to splash shield	6	
20	3120	Pointed screw	12	
21	212192	Spring washer	12	
22	7794	Plain washer	12	
23	512	Inner sill LH	1	
23	400	Inner sill RH	1	
24	3736	Channel door seal	2	
25	17720	Outer sill LH	1	
25	17721	Outer sill RH	1	
26	137	Closing panel sill end - LH front	1	
26	138	Closing panel sill end - RH front	1	
27	135	Closing panel sill end - LH rear	1	
27	136	Closing panel sill end - RH rear	1	
28	1129	,A' post LH outer panel	1	
28	1670	,A' post RH outer panel	1	
29	3017	Closing panel LH ,A' post	1	
29	1685	Closing panel RH ,A' post	1	
30	1678	Clamp door check strap - fixed on ,A' post	30	
31	7064	Pop rivet	4	
32	513	,B' post LH	1	
32	514	,B' post RH	1	
33	11452	,B' post LH front face	1	
33	11453	,B' post RH front face	1	
34	4708	Closing panel LH ,B' post	1	
34	4709	Closing panel RH ,B' post	1	
35	16562	Anchor plate LH seat belt	1	
35	16558	Anchor plate RH seat belt	1	
36	18013	Reinforcement LH sill to ,B' post	1	
36	18014	Reinforcement RH sill to ,B' post	1	
37	14926	Advance board 240 x 270 mm, 360° rotatable	1	Contains: supporting base and tear-off blocks with 2 x 50 working surfaces

15.11

Chassis and body panels

Inner body repair panels, front section - TR4 and TR4A

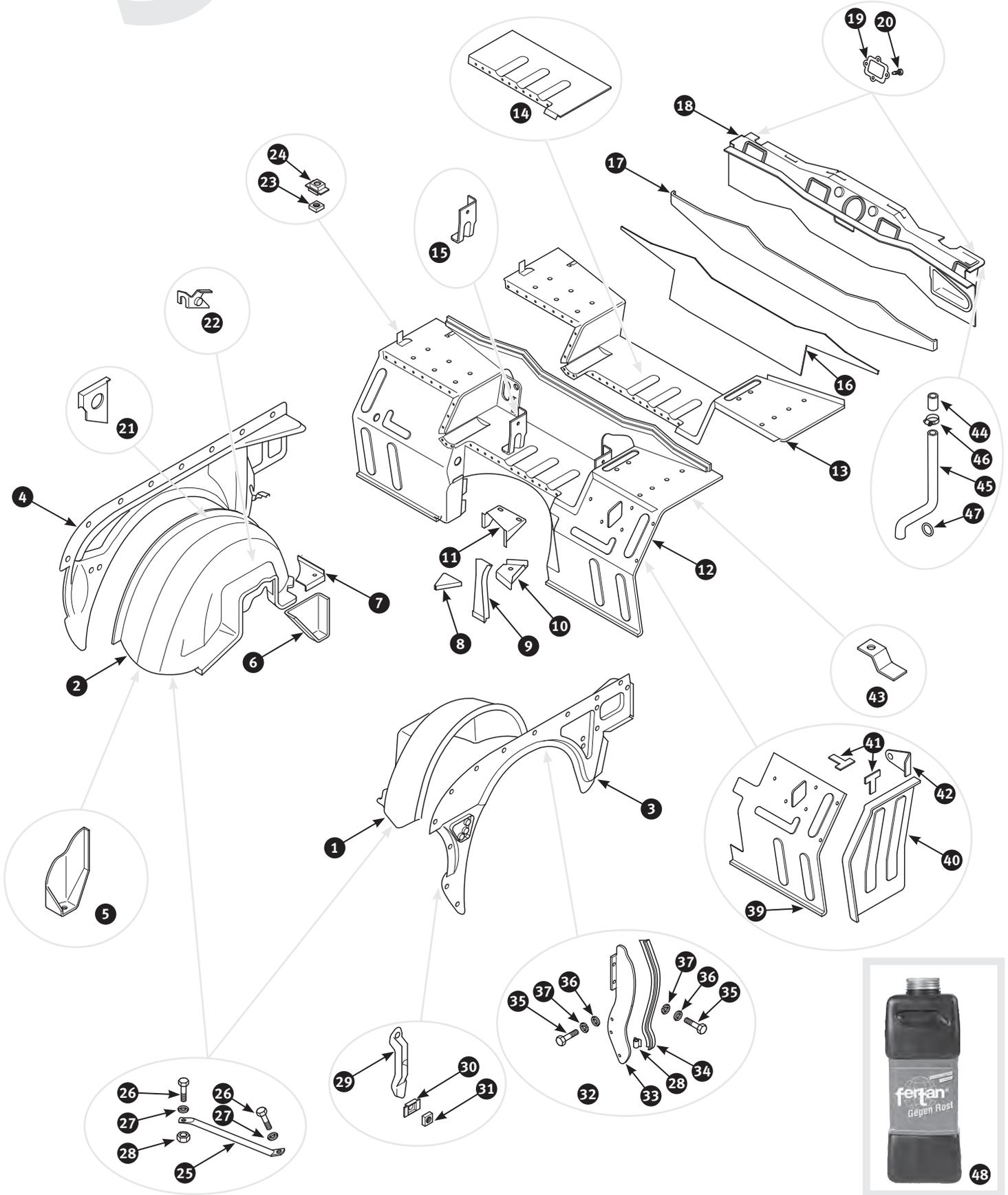

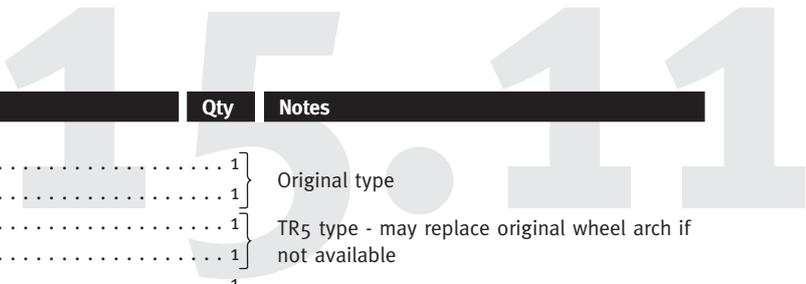

No	Part No	Description	Qty	Notes
1	478678	Wheel arch LH front	1	Original type
1	478679	Wheel arch RH front	1	
1	404	Wheel arch RH front	1	TR5 type - may replace original wheel arch if not available
1	403	Wheel arch LH front	1	
3	150	Inner wing LH front	1	
4	151	Inner wing RH front	1	
5	10307	Bracket LH front, front wheel arch to frame	1	
6	450775	Reinforcement front wheel arch, LH lower	1	
6	338233	Reinforcement front wheel arch, RH lower	1	
7	450774	Reinforcement front wheel arch, LH upper	1	
7	338232	Reinforcement upper RH, front wheel arch	1	
8	338056	Stiffener bulkhead strut	1	
9	338216	Strut bulkhead	1	
10	338178	Reinforcement dashboard, LH side	1	
11	367128	Mounting panel steering column strap	1	LHD
11	450151	Mounting panel steering column strap	1	RHD
12	22890	Bulkhead	1	LHD
12	22889	Bulkhead	1	RHD
13	338536	Repair panel bulkhead top	1	LHD
13	338534	Repair panel bulkhead top	1	RHD
14	338535	Shelf panel battery	1	
15	338045	Bracket LH battery stay	1	
15	14217	Bracket RH battery stay	1	
16	338255	Repair panel behind battery	1	LHD
16	338254	Repair panel behind battery	1	RHD
17	338256	Repair panel behind battery, upper section	1	
18	21439	Plenum assembly	1	
19	200521	Cover wheel box access	2	
20	5695	Self tapping screw cover to plenum	4	
21	338097	Bracket LH body lifting	1	
21	338098	Bracket RH body lifting	1	
22	1666	Bracket bonnet prop rod	1	
23	9662	Square nut	0	Quantity as required
24	10630	Cage for square nut	0	
25	203229	Stay front valance to LH wheel arch	1	
25	300809	Stay front valance to RH wheel arch	1	
26	3120	Pointed screw	4	
27	212192	Spring washer	4	
28	2828	Nut	2	
29	2556	Panel between front valance and LH wing	1	
29	2557	Panel between front valance and RH wing	1	
30	10630	Cage for square nut	4	
31	10629	Square nut	4	
32	338217	Splash shield LHLH - complete kit	1	With fittings and seal assembly
32	338218	Splash shield RHLH - complete kit	1	
33	474	Splash shield LH	1	
33	475	Splash shield RH	1	
34	446	Sealing rubber splash shield side	2	

15.11

Chassis and body panels

Inner body repair panels, front section - TR4 and TR4A

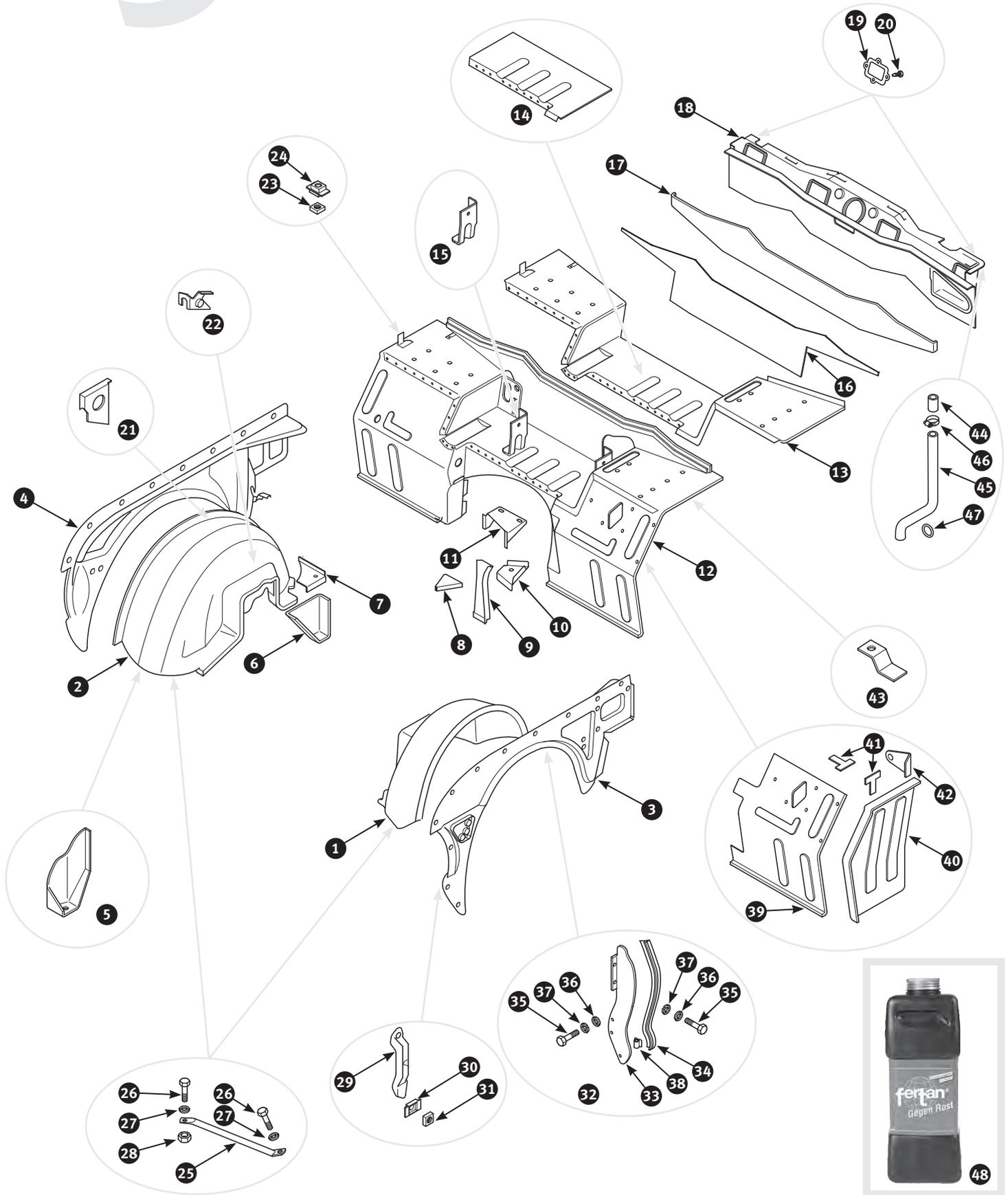

No	Part No	Description	Qty	Notes
35	3120	Pointed screw	12	
36	7794	Plain washer	12	
37	212192	Spring washer	12	
38	418	Retaining clip sealing rubber to splash shield	6	
39	308494	Toe board panel LH front	1	LHD
39	308493	Toe board panel RH front	1	
39	25125	Toe board panel LH front	1	RHD
39	25126	Toe board panel RH front	1	
40	1301	End panel bulkhead, LH side	1	
40	1933	End panel bulkhead, RH side	1	
41	10440	Support bracket wiring loom securing	0	For welding to front inner wing, Quantity as required
42	10257	Bracket bonnet cable	1	
43	338046	Bracket wiper motor mounting	2	
44	338163	Drain pipe plenum	2	
45	12307	Hose plenum drain	2	
46	1550	Hose clip	2	
47	4109	Grommet drain hose through splash shield	2	
48	316823	Fertan Rust converter 1 litre bottle	1	Ask for our special catalogue.

Order free of charge:



Tools catalogue

Order free of charge:

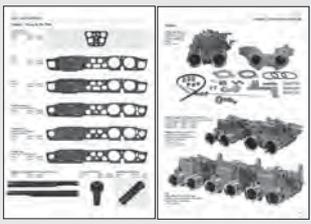

Tuning catalogue

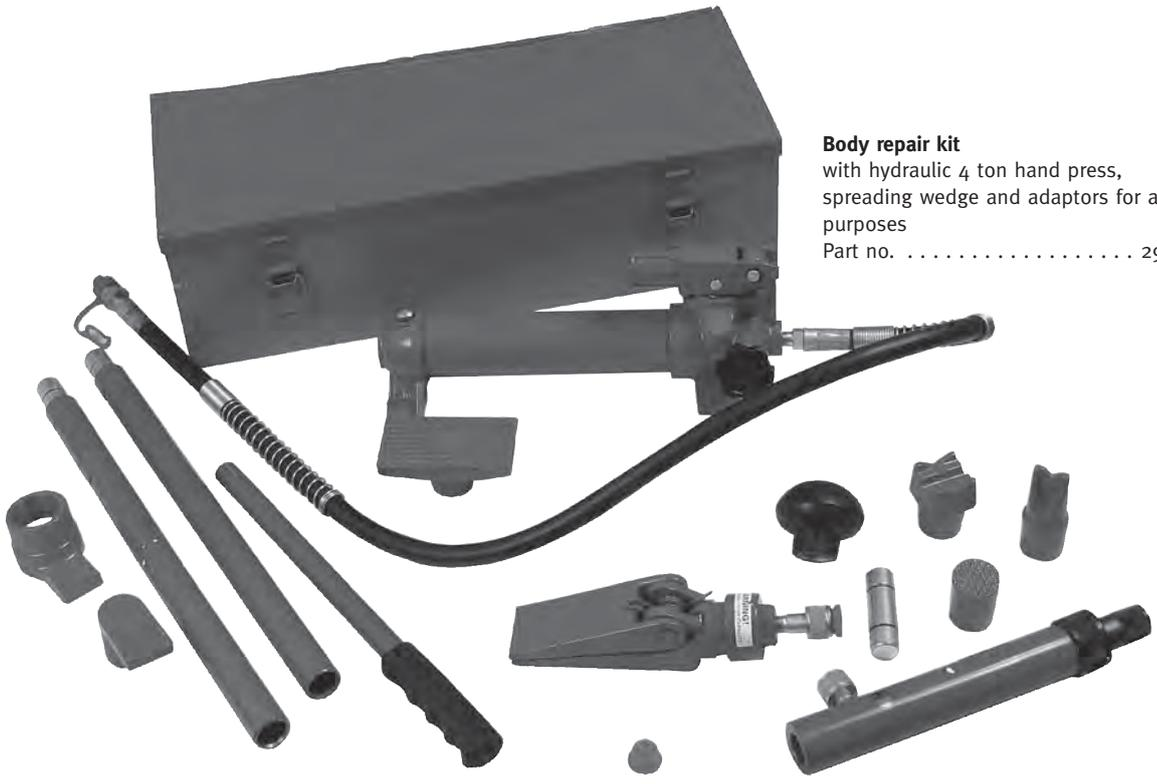

Body repair kit
with hydraulic 4 ton hand press,
spreading wedge and adaptors for all
purposes
Part no. 292101

15.12

Chassis and body panels Inner body repair panels, rear section - TR4 and TR4A

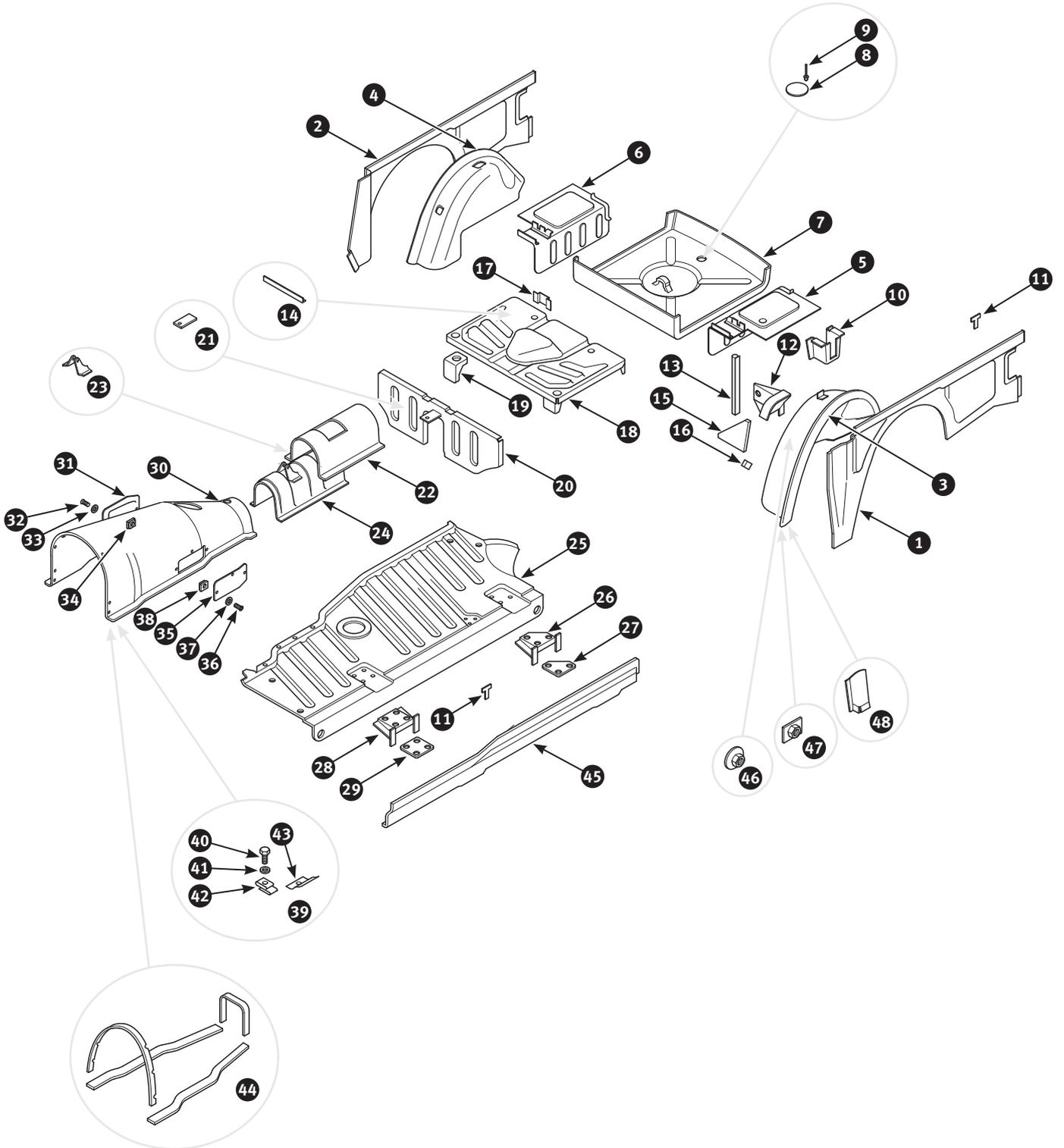

No	Part No	Description	Qty	Notes
1	510	Inner wing LH	1	
2	511	Inner wing RH	1	
3	11545	Wheel arch LH rear	1	TR4
4	11546	Wheel arch RH rear	1	
3	13738	Wheel arch LH rear	1	TR4A
4	13739	Wheel arch RH rear	1	
5	519	Boot floor LH	1	
6	520	Boot floor RH	1	
7	515	Spare wheel tray	1	
8	14151	Blanking plate Spare wheel tray	1	
9	4870	Pop rivet	2	
10	2783	Mounting bracket boot floor to frame	2	
11	10440	Support bracket wiring loom securing	0	For welding to inner wing and inner sill, Quantity as required
12	4807	Bracket LH fuel tank support	1	
12	4651	Bracket RH fuel tank support	1	
13	338219	Bracket vertical squab support	2	
14	4809	Bracket LH bottom squab support.	1	
14	4810	Bracket RH bottom squab support	1	
15	338227	Reinforcement LH rear floor to wheel arch	1	
15	338228	Reinforcement RH rear floor to wheel arch.	1	
16	338164	Bracket rear quarter panel	4	
17	16075	Tapped plate fuel tank to body.	2	
18	294842	Floor panel rear.	1	
19	451673	Heelboard reinforcement to rear floor	2	
20	19125	Heelboard	1	
21	338062	Bracket rear tunnel cover to heelboard	1	TR4A
22	1874	Cover handbrake cable - made from cardboard.	1	
22	323993	Cover handbrake cable - made from GFK	1	
23	300659	Bracket for anchoring handbrake lever.	1	
24	290316	Transmission tunnel	1	TR4
24	9784	Transmission tunnel	1	TR4A
25	537	Floor panel LH.	1	
25	186	Floor panel RH	1	
26	426	Bracket inner sill to LH rear chassis outrigger.	1	
26	427	Bracket inner sill to RH rear chassis outrigger	1	
27	16441	Packing plate on rear chassis outrigger	0	Quantity as required
28	473	Bracket inner sill to front chassis outrigger	2	
29	2225	Packing plate on outriggers	0	Quantity as required

Swissvax Nano Express

advanced quick refinisher set.
 Content: 250 ml pump spray, applicator
 and a special microfibre cloth.
 Part no. 436948

Swissvax Nano Express is the only product that removes
 pollutions, fine scratches, dust and fingerprints on all varnishes,
 rims, synthetic materials, aluminium and chrome within one
 operation. Modern and primarily 'real', extremely fine sprayed
 Nano-technology causes a brilliant gleam without any smearing
 film. Simply spray, apply with the pad and wipe off with Swissvax
 MicroAbsorb towel. The application works approx. one month. This
 is also not reached by any comparable competing product.



15.12

Chassis and body panels Inner body repair panels, rear section - TR4 and TR4A

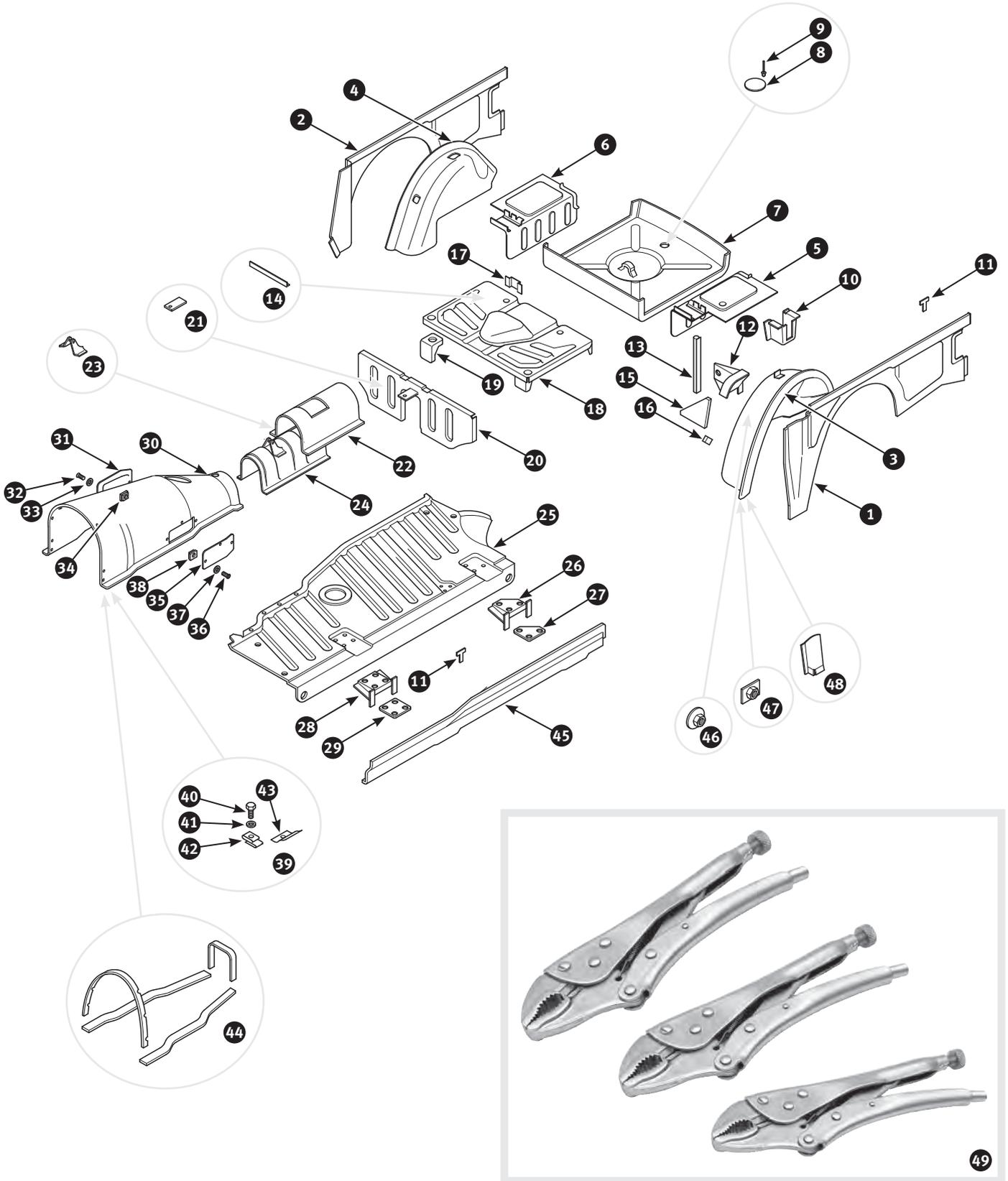

No	Part No	Description	Qty	Notes
30	25094	Gearbox tunnel - made from plastic	1	
30	2533	Gearbox tunnel - made from GFK	1	
31	3519	Cover gearbox tunnel, LH side	1	
32	3819	Self tapping screw	3	
33	1717	Plain washer	3	
34	3824	Spire nut	3	
35	1772	Cover gearbox tunnel, RH side	1	
36	5697	Self tapping screw	3	
37	1717	Plain washer	3	
38	11806	Spire nut	3	
39	21435	Fitting kit gearbox tunnel to body	1	
40	3120	Pointed screw - separately	20	
41	7794	Plain washer - separately	10	
42	16867	Captive nut - separately	7	
43	10356	Washer - separately	7	
44	16267	Seal kit gear box tunnel to body	1	
45	512	Inner sill LH	1	
45	400	Inner sill RH	1	
46	19288	Tapped plate securing seat belt on wheel arch	2	
47	338059	Tapped plate securing seat belt on inner sill	2	
48	450334	Bracket LH rear axle bump stop	1	
48	450335	Bracket RH rear axle bump stop	1	
49	300273	Grip pliers with curved jaws, supplied in a 3 piece set. 140, 190 and 220 mm long, made from hardened and tempered quality-steel	1	

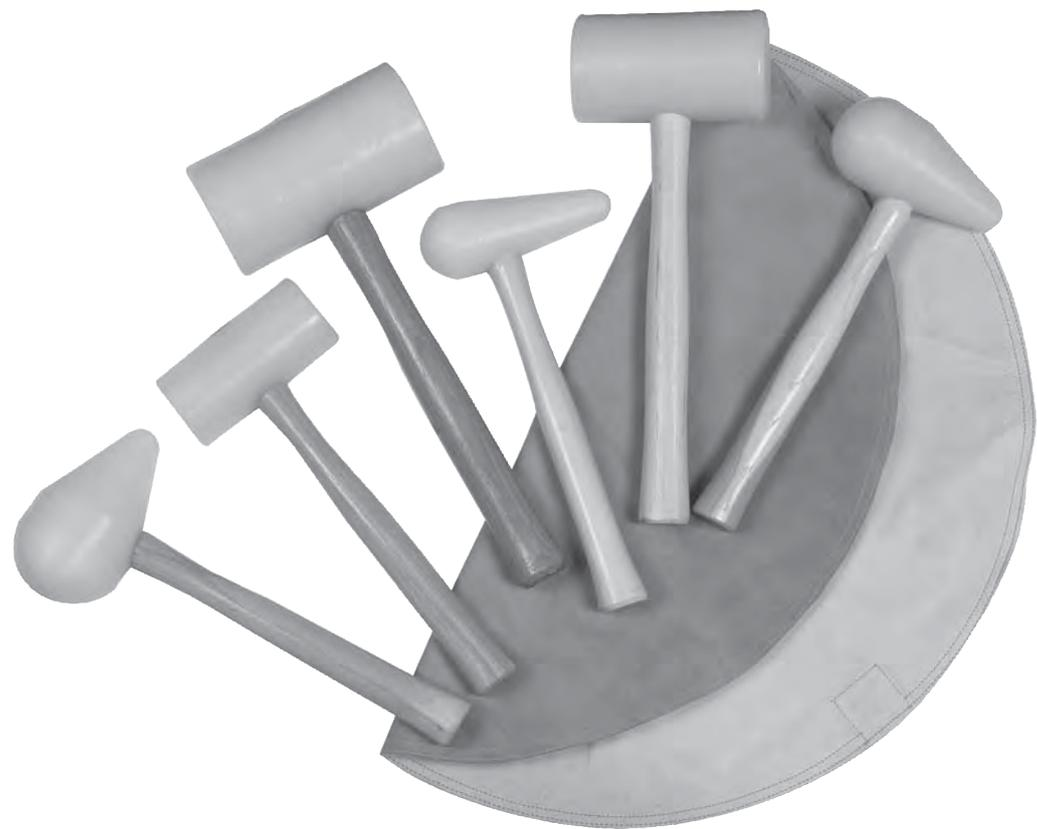

Hammer set
 supplied in a 6 piece set. Contents: 3 pear shaped and 3 cylindrical super plastic mallets with nicely finished wooden handles. Length: 360 mm. The absolute solution for professional panel beating and body work. Our yellow ultra-high-molecular-weight plastic mallets stretch and form sheet metal.
 Part no. 287477

Panel beater sand bag
 for the manual forming of sheet metal. Made of genuine heavy duty leather, diameter: 55 cms
 Part no. 394574

15.13

Chassis and body panels Grommets and blanking plugs - TR2 to TR3B

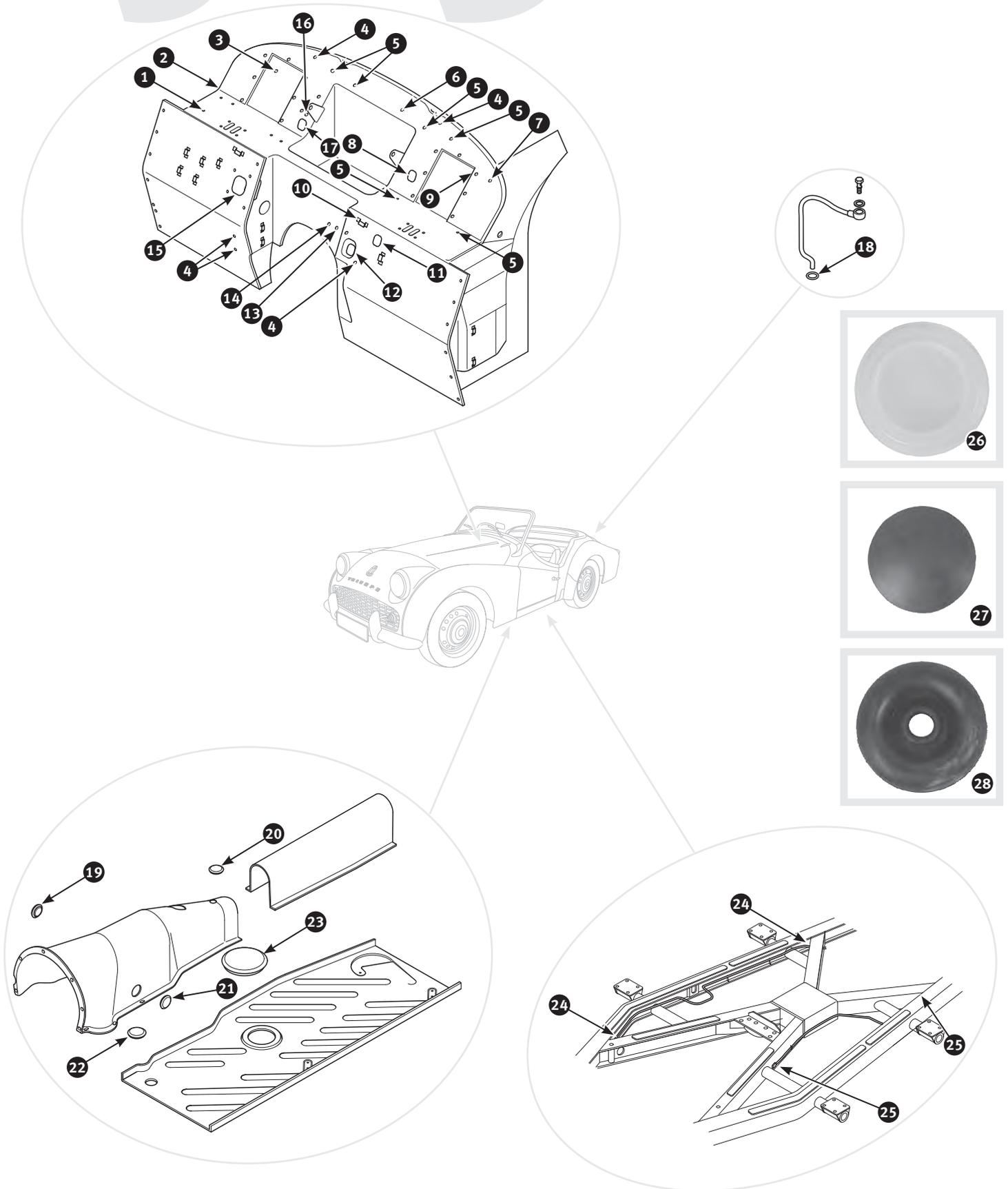

No	Part No	Description	Qty	Notes
1	3792	Blanking plug outer diameter: 1/2", for 3/8" hole	0	Quantity as required
2	26169	Grommet bonnet release cable through bulkhead	1	
2	10060	Blanking plug bonnet release cable hole	1	TR2 to TS4228
3	12620	Grommet wiper casing through bulkhead	1	TR2 from TS4229
3	4110	Blanking plug wiper casing hole through bulkhead	1	TR2, TR3 to TS12569
4	10060	Blanking plug outer diameter: 19/32", for 3/8" mm hole	0	Quantity as required
5	3792	Blanking plug outer diameter: 1/2", for 3/8" hole	0	
6	22735	Grommet oil pressure pipe through bulkhead	1	Quantity as required
7	209383	Grommet wiper casing through bulkhead	1	
8	22735	Grommet speedo cable through bulkhead	1	
9	313796	Blanking plug outer diameter: 1 1/8", for 13/16" hole.	1	Quantity as required
10	2485	Rubber seal on bulkhead adaptor	1	
11	11467	Grommet wiring harness through bulkhead	1	Cars fitted with heater unit
12	2518	Gaiter steering column through bulkhead.	1	
13	22735	Grommet tachometer cable through bulkhead	1	
14	22735	Grommet capillary pipe through bulkhead	1	
15	289160	Seal closing steering column aperture in bulkhead	1	
16	10242	Blanking plug outer diameter: 1.13/16", hole: 1.1/2".	1	
17	1600	Blanking plug outer diameter: 1 21/64", for 1" hole	1	
18	26169	Grommet with 1/2" hole	1	Fuel tank vent pipe through boot floor
18	22735	Grommet with 1" hole	1	
19	2500	Blanking plug RH, gearbox dipstick access.	1	TR2 and TR3, TR3A to TS5000
20	2500	Blanking plug front propshaft universal joint access	1	
21	1600	Blanking plug gearbox tunnel, LH side.	1	Cars without overdrive
21	22735	Grommet gearbox tunnel, LH side	1	Cars with overdrive
22	1600	Blanking plug floor panel, front	2	
23	2186	Blanking plug in floor panel, hole for jack	2	
24	13655	Grommet brake pipe through frame.	2	
25	13655	Grommet fuel pipe through frame	2	
26	7042	Blanking plug plastic - hole: 3/8"	0	Quantity as required
26	7043	Blanking plug plastic - hole: 5/8"	0	
26	7044	Blanking plug plastic - hole: 3/4"	0	
26	7045	Blanking plug plastic - hole: 1"	0	
26	6578	Blanking plug plastic - hole: 1.1/2"	0	
27	5478	Blanking plug rubber - hole: 1/4"	0	
27	7804	Blanking plug rubber - hole: 3/8"	0	Quantity as required
27	7809	Blanking plug rubber - hole: 1/2"	0	
27	4110	Blanking plug rubber - hole: 5/8"	0	
27	7810	Blanking plug rubber - hole: 3/4"	0	
27	10529	Blanking plug rubber - hole: 13/16"	0	
27	4286	Blanking plug rubber - hole: 1"	0	
27	16134	Blanking plug rubber - hole: 1.1/8"	0	Quantity as required
27	10242	Blanking plug rubber - hole: 1.1/2"	0	
28	209347	Grommet outer diameter: 9 mm, for 6 mm hole and 2 mm cable	0	
28	204765	Grommet outer diameter: 15 mm, for 13 mm hole and 4 mm cable	0	
28	4533	Grommet outer diameter: 17 mm, for 13 mm hole and 9 mm cable	0	
28	26169	Grommet outer diameter: 18 mm, for 13 mm hole and 3 mm cable	0	
28	205404	Grommet outer diameter: 18 mm, for 13 mm hole and 8 mm cable	0	Quantity as required
28	207357	Grommet outer diameter: 20 mm, for 17 mm hole and 9 mm cable	0	
28	16135	Grommet outer diameter: 20 mm, for 17 mm hole and 5 mm cable	0	
28	18631	Grommet outer diameter: 21 mm, for 14 mm hole and 9 mm cable	0	

15.13

Chassis and body panels Grommets and blanking plugs - TR2 to TR3B

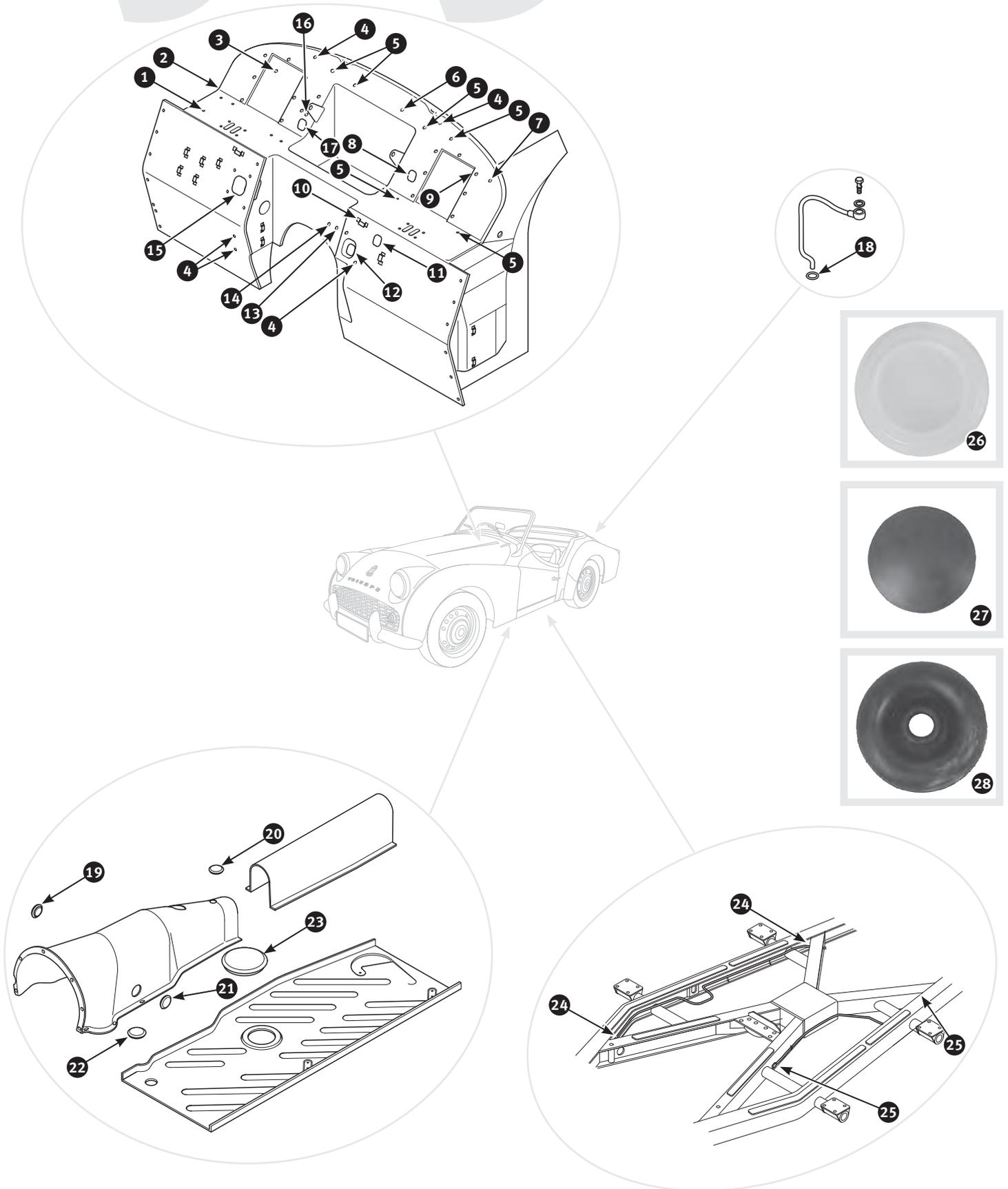

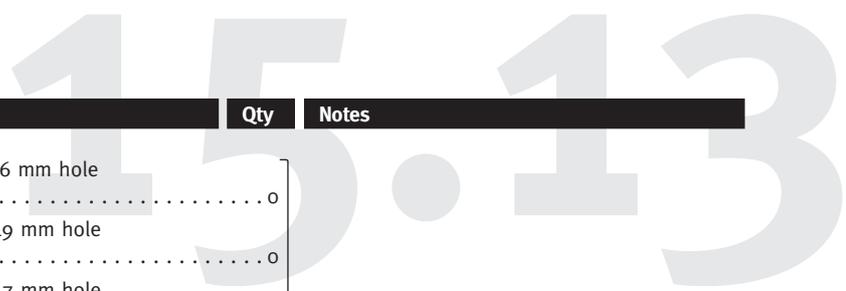

No	Part No	Description	Qty	Notes
28	4285	Grommet outer diameter: 21 mm, for 16 mm hole and 5 mm cable	0	Quantity as required
28	8513	Grommet outer diameter: 22 mm, for 19 mm hole and 14 mm cable.	0	
28	8488	Grommet outer diameter: 24 mm, for 17 mm hole and 4 mm cable	0	
28	8489	Grommet outer diameter: 25 mm, for 17 mm hole and 2 mm cable.	0	
28	26168	Grommet outer diameter: 25 mm, for 19 mm hole and 3 mm cable	0	
28	209348	Grommet outer diameter: 28 mm, for 23 mm hole and 7 mm cable.	0	
28	5477	Grommet outer diameter: 28 mm, for 23 mm hole and 12 mm cable.	0	
28	7811	Grommet outer diameter: 31 mm, for 25 mm hole and 5 mm cable	0	
28	26170	Grommet outer diameter: 32 mm, for 19 mm hole and 14 mm cable.	0	
28	6065	Grommet outer diameter: 32 mm, for 27 mm hole and 9 mm cable	0	
28	22735	Grommet outer diameter: 34 mm, for 25 mm hole and 8 mm cable	0	
28	13655	Grommet outer diameter: 39 mm, for 25 mm hole and 19 mm cable.	0	
28	209382	Grommet outer diameter: 40 mm, for 32 mm hole and 4 mm cable	0	
28	209385	Grommet outer diameter: 40 mm, for 32 mm hole and 10 mm cable.	0	
28	11410	Grommet outer diameter: 44 mm, for 29 mm hole and 25 mm cable	0	
28	4109	Grommet outer diameter: 44 mm, for 31 mm hole and 21 mm cable.	0	
28	19342	Grommet outer diameter: 46 mm, for 29 mm hole and 25 mm cable	0	
28	11467	Grommet outer diameter: 46 mm, for 38 mm hole and 17 mm cable.	0	
28	209349	Grommet outer diameter: 47 mm, for 38 mm hole and 10 mm cable.	0	
28	213697	Grommet outer diameter: 51 mm, for 38 mm hole and 13 mm cable.	0	
28	26172	Grommet outer diameter: 53 mm, for 38 mm hole and 32 mm cable	0	
28	204153	Grommet outer diameter: 56 mm, for 39 mm hole and 16 mm cable.	0	
28	9160	Grommet outer diameter: 56 mm, for 49 mm hole and 14 mm cable.	0	
28	20374	Grommet outer diameter: 57 mm, for 47 mm hole and 31 mm cable.	0	
28	209351	Grommet outer diameter: 58 mm, for 44 mm hole and 37 mm cable	0	
28	209518	Grommet outer diameter: 67 mm, for 61 mm hole and 52 mm cable	0	
28	447	Grommet outer diameter: 69 mm, for 65 mm hole and 52 mm cable	0	

15.14

Chassis and body panels

Grommets and blanking plugs - TR4 and TR4A

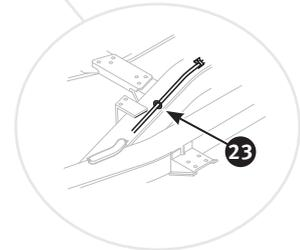
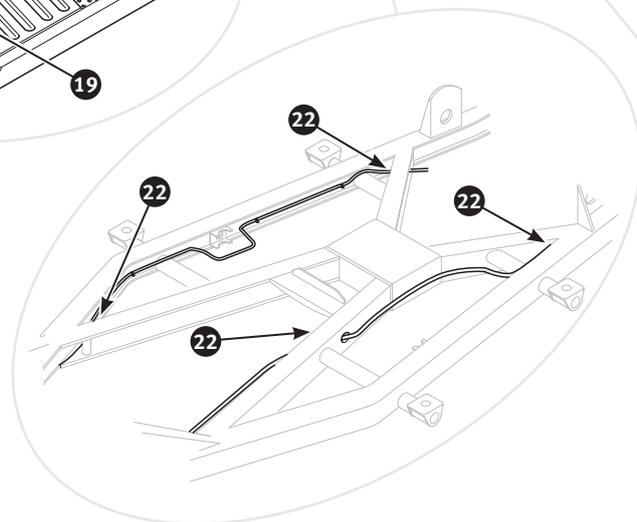
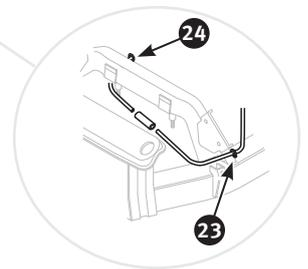
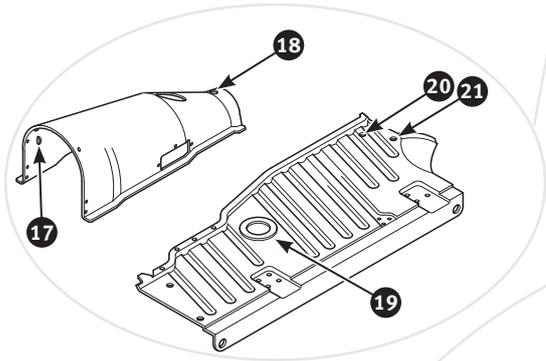
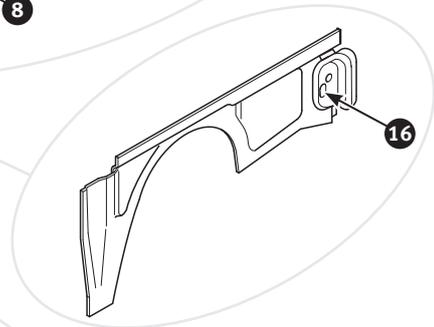
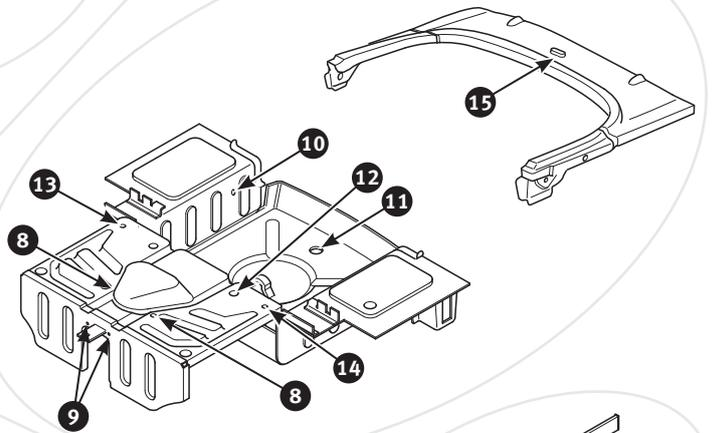
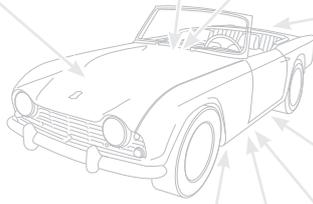
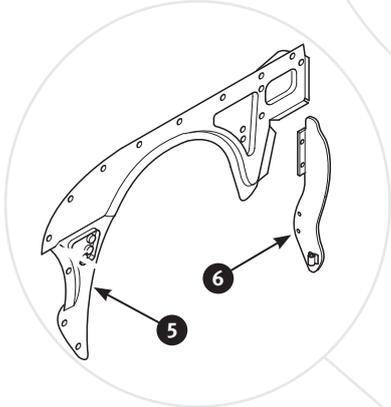
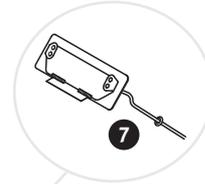
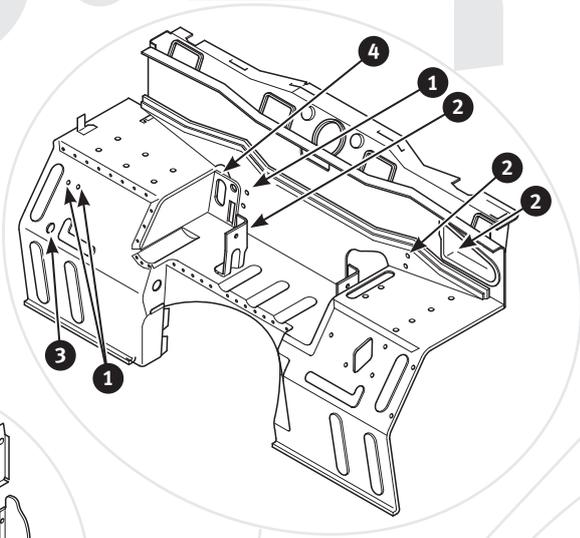

No	Part No	Description	Qty	Notes
1	26169	Grommet choke-, heater- and bonnet release cable, and also wiper washer hose through bulkhead	4	
2	22735	Grommet wiper drive-, tacho-, speedo-, and heater control cable, and also oil pressure pipe through bulkhead	5	
3	11467	Grommet wiring harness through bulkhead	1	
4	2212	Grommet outer steering tube through bulkhead	1	
5	26169	Grommet side lamp cable through front inner wing.	2	TR4A
6	4109	Grommet plenum drain hose through splash shield.	2	
7	26169	Grommet vent lid operating rod	1	
8	5767	Rebound buffer outer diameter: 9/16", for 5/16" hole	1	
9	22735	Grommet handbrake cable through heelboard	2	TR4A
10	22735	Grommet for number plate lamp cable.	2	
10	1600	Blanking plug for number plate lamp cable	2	Cars without number plate lamps
11	1600	Blanking plug drain hole in spare wheel pan - rubber.	1	
11	14151	Blanking plate drain hole in spare wheel pan - metal	1	Alternatives
12	22735	Grommet fuel pipe to fuel tank.	1	
13	22735	Grommet fuel tank vent pipe	1	
14	1600	Blanking plug drain holes on side of fuel tank	2	
15	447	Grommet fuel tank neck through rear deck.	1	TR4A
16	22735	Grommet for rear lamp cable	2	
17	22735	Grommet harness through gearbox tunnel	1	
18	2500	Blanking plug front propshaft universal joint access	1	
19	2186	Blanking plug in floor panel, hole for jack	2	
20	1600	Blanking plug floor panel, rear inner	2	
21	4110	Blanking plug floor panel, rear outer.	2	
22	13655	Grommet fuel pipe and brake pipe through frame.	4	TR4 TR4A
23	13655	Grommet fuel pipe through frame	2	
24	16497	Plug in rear crossmember.	1	
25	7042	Blanking plug plastic - hole: 3/8"	0	Quantity as required
25	7043	Blanking plug plastic - hole: 5/8"	0	
25	7044	Blanking plug plastic - hole: 3/4"	0	
25	7045	Blanking plug plastic - hole: 1"	0	
25	6578	Blanking plug plastic - hole: 1.1/2"	0	
26	5478	Blanking plug rubber - hole: 1/4"	0	Quantity as required
26	7804	Blanking plug rubber - hole: 3/8"	0	
26	7809	Blanking plug rubber - hole: 1/2"	0	
26	4110	Blanking plug rubber - hole: 5/8"	0	
26	7810	Blanking plug rubber - hole: 3/4"	0	
26	10529	Blanking plug rubber - hole: 13/16"	0	Quantity as required
26	4286	Blanking plug rubber - hole: 1"	0	
26	16134	Blanking plug rubber - hole: 1.1/8"	0	
26	10242	Blanking plug rubber - hole: 1.1/2"	0	
27	209347	Grommet outer diameter: 9 mm, for 6 mm hole and 2 mm cable	0	
27	204765	Grommet outer diameter: 15 mm, for 13 mm hole and 4 mm cable	0	
27	4533	Grommet outer diameter: 17 mm, for 13 mm hole and 9 mm cable	0	
27	26169	Grommet outer diameter: 18 mm, for 13 mm hole and 3 mm cable	0	Quantity as required
27	205404	Grommet outer diameter: 18 mm, for 13 mm hole and 8 mm cable	0	
27	207357	Grommet outer diameter: 20 mm, for 17 mm hole and 9 mm cable	0	
27	16135	Grommet outer diameter: 20 mm, for 17 mm hole and 5 mm cable	0	
27	18631	Grommet outer diameter: 21 mm, for 14 mm hole and 9 mm cable	0	

15.14

Chassis and body panels

Grommets and blanking plugs - TR4 and TR4A

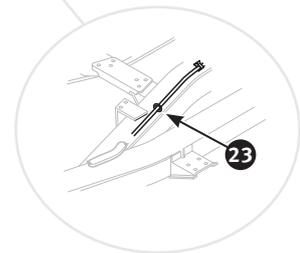
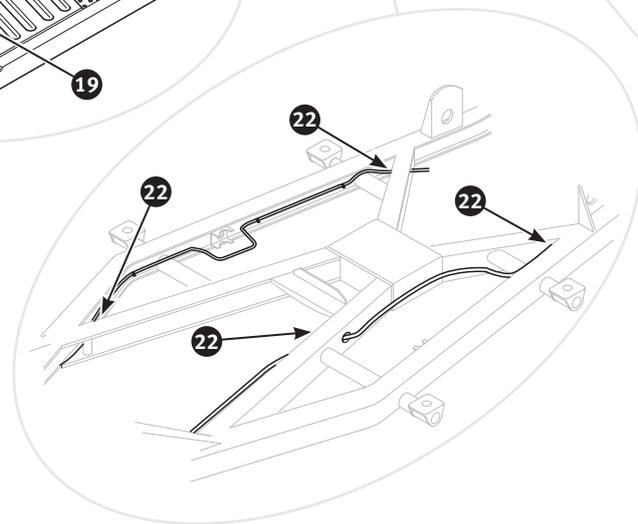
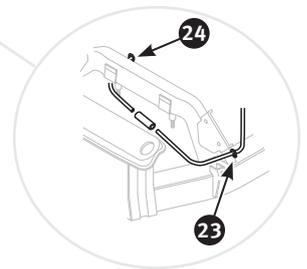
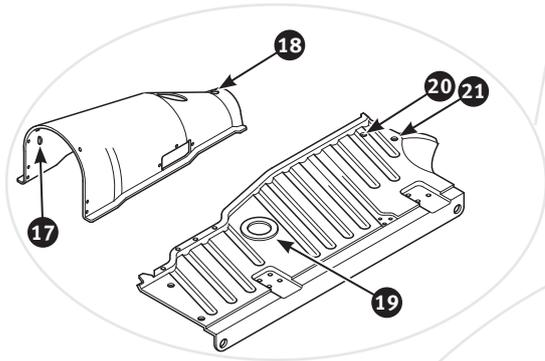
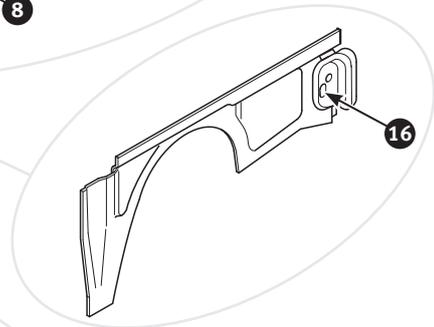
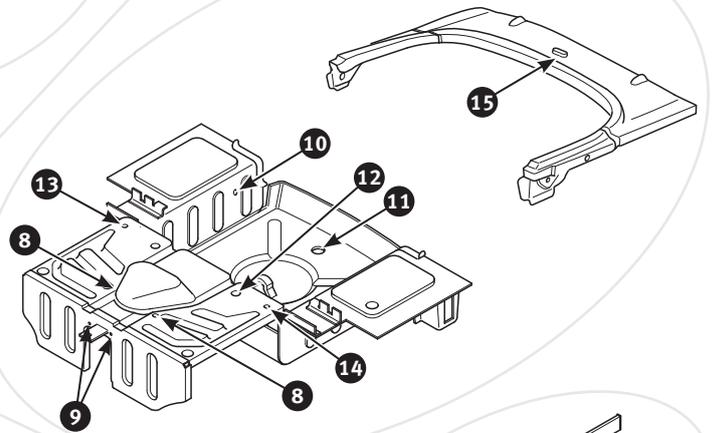
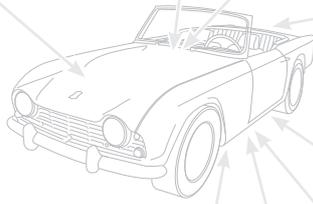
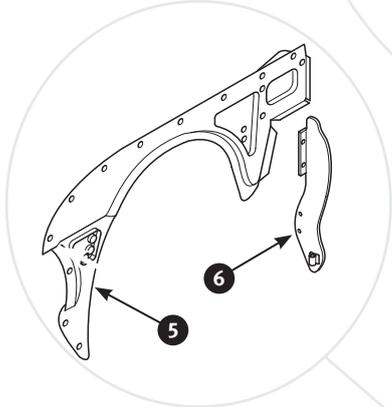
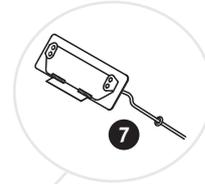
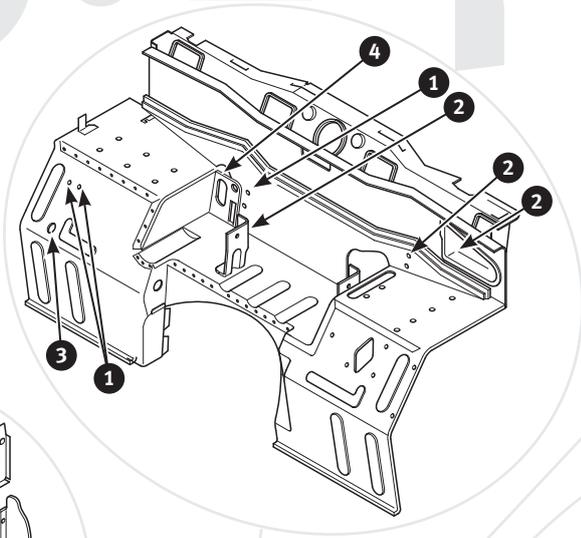

15.14

No	Part No	Description	Qty	Notes
27	4285	Grommet outer diameter: 21 mm, for 16 mm hole and 5 mm cable	0	} Quantity as required
27	8513	Grommet outer diameter: 22 mm, for 19 mm hole and 14 mm cable	0	
27	8488	Grommet outer diameter: 24 mm, for 17 mm hole and 4 mm cable	0	
27	8489	Grommet outer diameter: 25 mm, for 17 mm hole and 2 mm cable	0	
27	26168	Grommet outer diameter: 25 mm, for 19 mm hole and 3 mm cable	0	
27	209348	Grommet outer diameter: 28 mm, for 23 mm hole and 7 mm cable	0	
27	5477	Grommet outer diameter: 28 mm, for 23 mm hole and 12 mm cable	0	
27	7811	Grommet outer diameter: 31 mm, for 25 mm hole and 5 mm cable	0	
27	26170	Grommet outer diameter: 32 mm, for 19 mm hole and 14 mm cable	0	
27	6065	Grommet outer diameter: 32 mm, for 27 mm hole and 9 mm cable	0	
27	22735	Grommet outer diameter: 34 mm, for 25 mm hole and 8 mm cable	0	
27	13655	Grommet outer diameter: 39 mm, for 25 mm hole and 19 mm cable	0	
27	209382	Grommet outer diameter: 40 mm, for 32 mm hole and 4 mm cable	0	
27	209385	Grommet outer diameter: 40 mm, for 32 mm hole and 10 mm cable	0	
27	11410	Grommet outer diameter: 44 mm, for 29 mm hole and 25 mm cable	0	
27	4109	Grommet outer diameter: 44 mm, for 31 mm hole and 21 mm cable	0	
27	19342	Grommet outer diameter: 46 mm, for 29 mm hole and 25 mm cable	0	
27	11467	Grommet outer diameter: 46 mm, for 38 mm hole and 17 mm cable	0	
27	209349	Grommet outer diameter: 47 mm, for 38 mm hole and 10 mm cable	0	
27	213697	Grommet outer diameter: 51 mm, for 38 mm hole and 13 mm cable	0	
27	26172	Grommet outer diameter: 53 mm, for 38 mm hole and 32 mm cable	0	
27	204153	Grommet outer diameter: 56 mm, for 39 mm hole and 16 mm cable	0	
27	9160	Grommet outer diameter: 56 mm, for 49 mm hole and 14 mm cable	0	
27	20374	Grommet outer diameter: 57 mm, for 47 mm hole and 31 mm cable	0	
27	209351	Grommet outer diameter: 58 mm, for 44 mm hole and 37 mm cable	0	
27	209518	Grommet outer diameter: 67 mm, for 61 mm hole and 52 mm cable	0	
27	447	Grommet outer diameter: 69 mm, for 65 mm hole and 52 mm cable	0	

16.1

Bumpers

Bumpers - TR2 and TR3

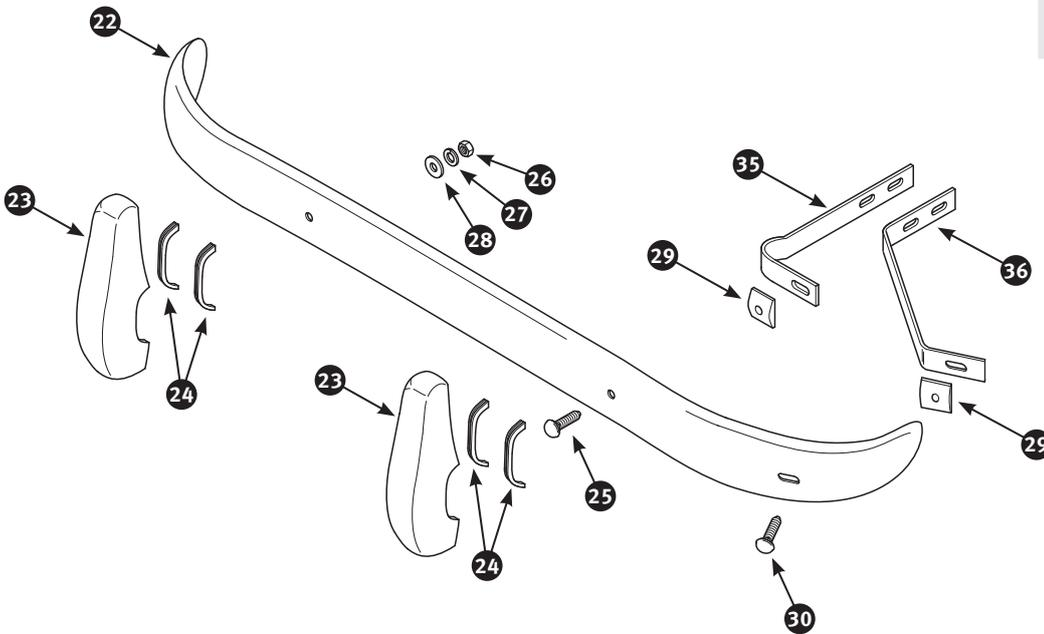
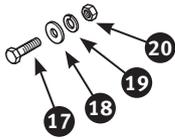
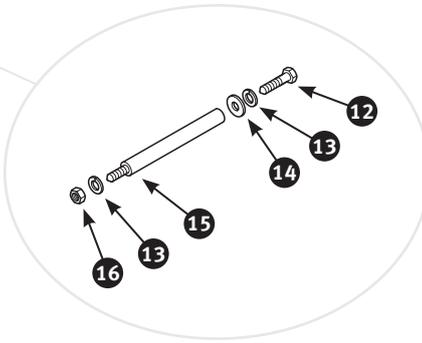
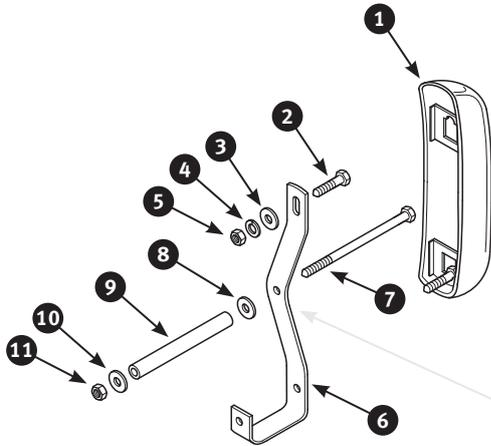

No	Part No	Description	Qty	Notes
1	2516	Override rear	2	
2	214671	Bolt with nut - chromed	2	
3	9671	Plain washer	2	
4	2051	Spring washer	2	
5	3073	Nut	2	
6	317249	Bumper bracket rear	2	
7	10727	Bolt bumper bracket support	2	} Original style
8	212195	Plain washer	2	
9	11240	Distance tube bumper bracket support	2	
10	2051	Spring washer	2	
11	3073	Nut	2	
12	3800	Screw bumper bracket support	2	} Replacement - may replace original support
13	2051	Spring washer	4	
14	212195	Plain washer	2	
15	215012	Distance tube bumper bracket support	2	
16	3073	Nut	2	
17	213887	Screw bumper bracket to chassis	2	
18	212195	Plain washer	2	
19	2051	Spring washer	2	
20	3073	Nut	2	
21	485449	Luster Lace Chrome polish 216 ml bottle	1	} Ask for our special catalogue.
22	12093	Bumper front.	1	
23	11300	Override front	2	
24	202301	Rubber seal override to bumper.	4	
25	214671	Bolt with nut - override to bracket.	2	
26	3073	Nut	4	
27	2051	Spring washer	4	
28	9671	Plain washer	4	
29	5743	Spacer plate	4	
30	214671	Bolt with nut - front bumper to bumper bracket	2	
31	3073	Nut	4	
32	2051	Spring washer	4	
33	9671	Plain washer	4	
34	5330	Bolt bumper bracket to chassis.	4	
35	16477	Bumper bracket front - LH inner	1	
35	16476	Bumper bracket front - RH inner	1	
36	16474	Bumper bracket front - LH outer	1	
36	16475	Bumper bracket front - RH outer	1	
37	361791	Fitting kit front bumper - 36 piece.	1	

Spot lamp
 pedestal mounting type with 5.3/4"
 diameter. With clear lens and chromed
 bowl
 Part no. 214046



Order free of charge:

Tuning catalogue

16.2

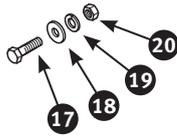
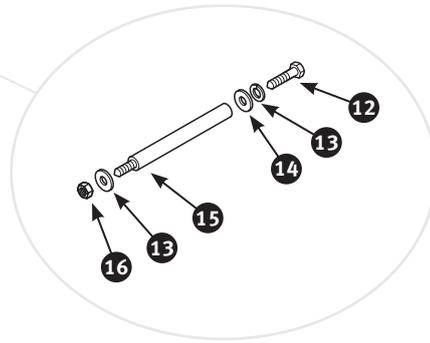
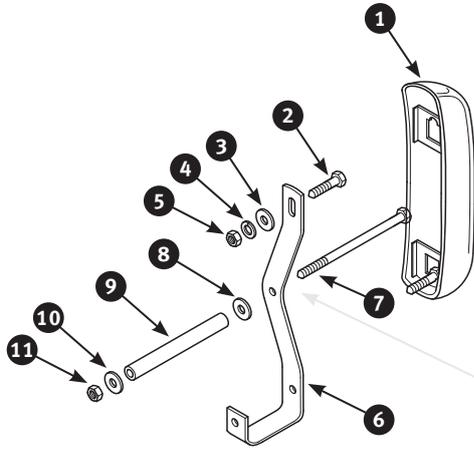

21

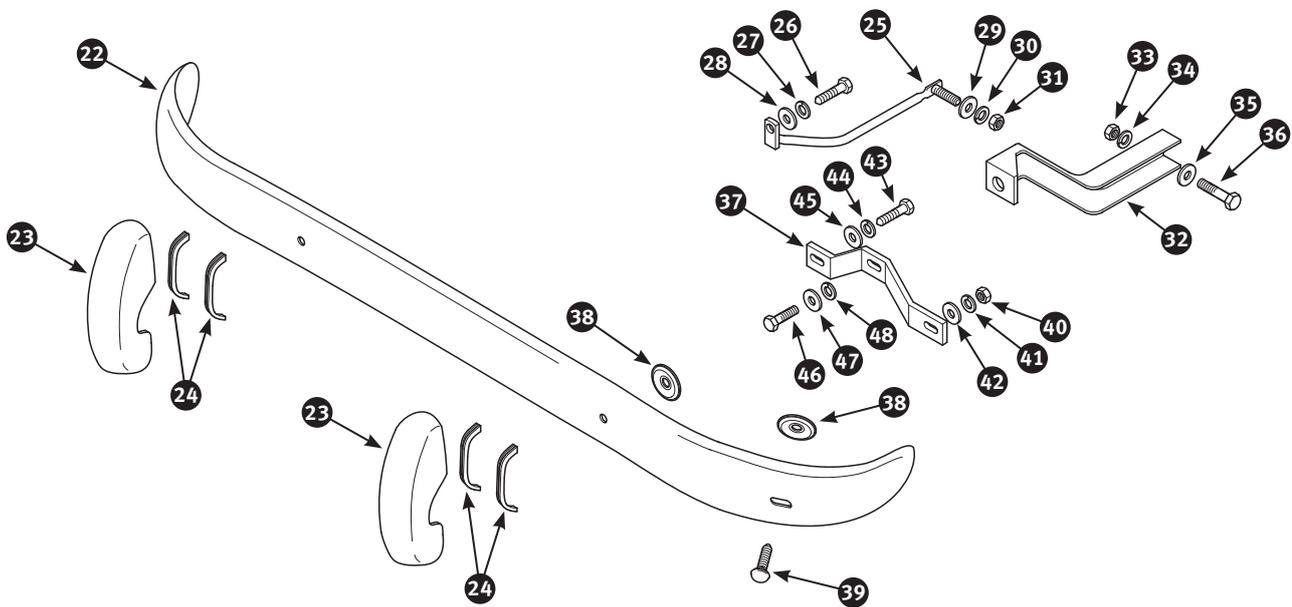

49

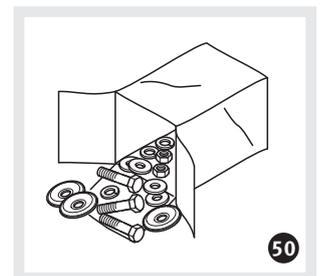

50

No	Part No	Description	Qty	Notes
1	2516	Override rear	2	
2	214671	Bolt with nut - chromed	2	
3	9671	Plain washer	2	
4	2051	Spring washer	2	
5	3073	Nut	2	
6	317249	Bumper bracket rear	2	
7	10727	Bolt bumper bracket support	2	} Original style
8	212195	Plain washer	2	
9	11240	Distance tube bumper bracket support	2	
10	2051	Spring washer	2	
11	3073	Nut	2	
12	3800	Screw bumper bracket support	2	} Replacement - may replace original support
13	2051	Spring washer	4	
14	212195	Plain washer	2	
15	215012	Distance tube bumper bracket support	2	
16	3073	Nut	2	
17	213887	Screw bumper bracket to chassis	2	
18	212195	Plain washer	2	
19	2051	Spring washer	2	
20	3073	Nut	2	
21	485449	Luster Lace Chrome polish 216 ml bottle	1	} Ask for our special catalogue.
22	479	Bumper front.	1	
23	2525	Override front	2	
24	202301	Rubber seal override to bumper.	4	
25	112	Stay LH front override.	1	
25	113	Stay RH front override.	1	
26	3800	Screw stay to override	2	
27	212195	Plain washer	2	
28	2051	Spring washer	2	
29	5337	Plain washer	2	
30	212194	Spring washer	2	
31	2303	Nut stay to inner front wing	2	
32	203808	Chassis outrigger LH front	1	
31	203807	Chassis outrigger RH front	1	
33	3073	Nut	4	
34	2051	Spring washer	4	
35	9671	Plain washer	4	
36	6540	Bolt outrigger to chassis	3	} Length: 3.1/4"
36	17902	Bolt outrigger to chassis	1	
37	114	Bumper bracket front.	2	
38	11409	Spacing washer front bumper to bumper bracket	4	
39	214671	Bolt with nut - front bumper to bumper bracket	2	
40	3073	Nut	2	
41	2051	Spring washer	2	
42	9671	Plain washer	2	
43	3382	Bolt bumper bracket to override	2	
44	2051	Spring washer	2	
45	9671	Plain washer	2	
46	4893	Bolt bumper bracket to chassis outrigger.	2	
47	2051	Spring washer	2	
48	9671	Plain washer	2	
49	487106	Bumper kit 5 pieces, front bumper including front and rear override - stainless steel, mirror polished	1	} TR3A and TR3B
50	338222	Fitting kit front bumper - 52 piece.	1	

No	Part No	Description	Qty	Notes
1	12098	Bumper rear	1	
2	2528	Override RH rear.	1	} With hole for number plate lamp
3	2527	Override LH rear.	1	
4	202301	Rubber seal override to bumper.	4	
5	21372	Stay RH rear override	1	
6	21371	Stay LH rear override	1	
7	7893	Screw stay to override	2	
8	212194	Spring washer	2	
9	212193	Plain washer	2	
10	213886	Screw stay to chassis.	2	
11	212195	Plain washer	2	
12	2051	Spring washer	2	
13	3073	Nut	2	
14	213888	Screw bumper bracket to chassis	2	
15	2051	Spring washer	2	
16	212195	Plain washer	2	
17	5018	Chassis outrigger RH rear.	1	
18	11909	Chassis outrigger LH rear	1	
19	338172	Bumper bracket rear inner - new item	2	
19	16254	Bumper bracket rear inner - used item.	2	
20	325897	Bumper bracket rear outer - new item	2	
20	21370	Bumper bracket rear outer - used item	2	
21	213889	Bolt override to bracket	2	
22	2051	Spring washer	2	
23	212195	Plain washer	2	
24	11409	Spacing washer front bumper to bumper bracket	4	
25	214671	Bolt with nut - rear bumper to bumper bracket	2	
26	212195	Plain washer	2	
27	2051	Spring washer	2	
28	3073	Nut	2	
29	6540	Bolt bumper bracket to chassis.	2	
30	212195	Plain washer	4	
31	3073	Nut	2	
32	2051	Spring washer	2	
33	7898	Screw outrigger to chassis	4	
34	212194	Spring washer	4	
35	212195	Plain washer	4	
36	3073	Nut	6	} Bumper side to outrigger - TR4 LHD to CT3018, TR4 RHD to CT2842
37	212192	Spring washer	6	
38	212195	Plain washer	6	
39	20852	Stud	2	
40	9811	Captive nut	2	} Bumper side to outrigger - TR4 LHD from CT3019, TR4 RHD from CT2843
41	5327	Bolt	2	
42	2051	Spring washer	2	
43	212195	Plain washer	6	
44	11243	Distance tube	2	
45	9811	Captive nut	2	
46	338486	Fitting kit rear bumper - 76 piece	1	
47	2542	Bumper front.	1	
48	1353	Override front	2	
49	202301	Rubber seal override to bumper.	4	
50	204565	Stay RH front override to wheel arch	1	

16.3

Bumpers

Bumpers - TR4

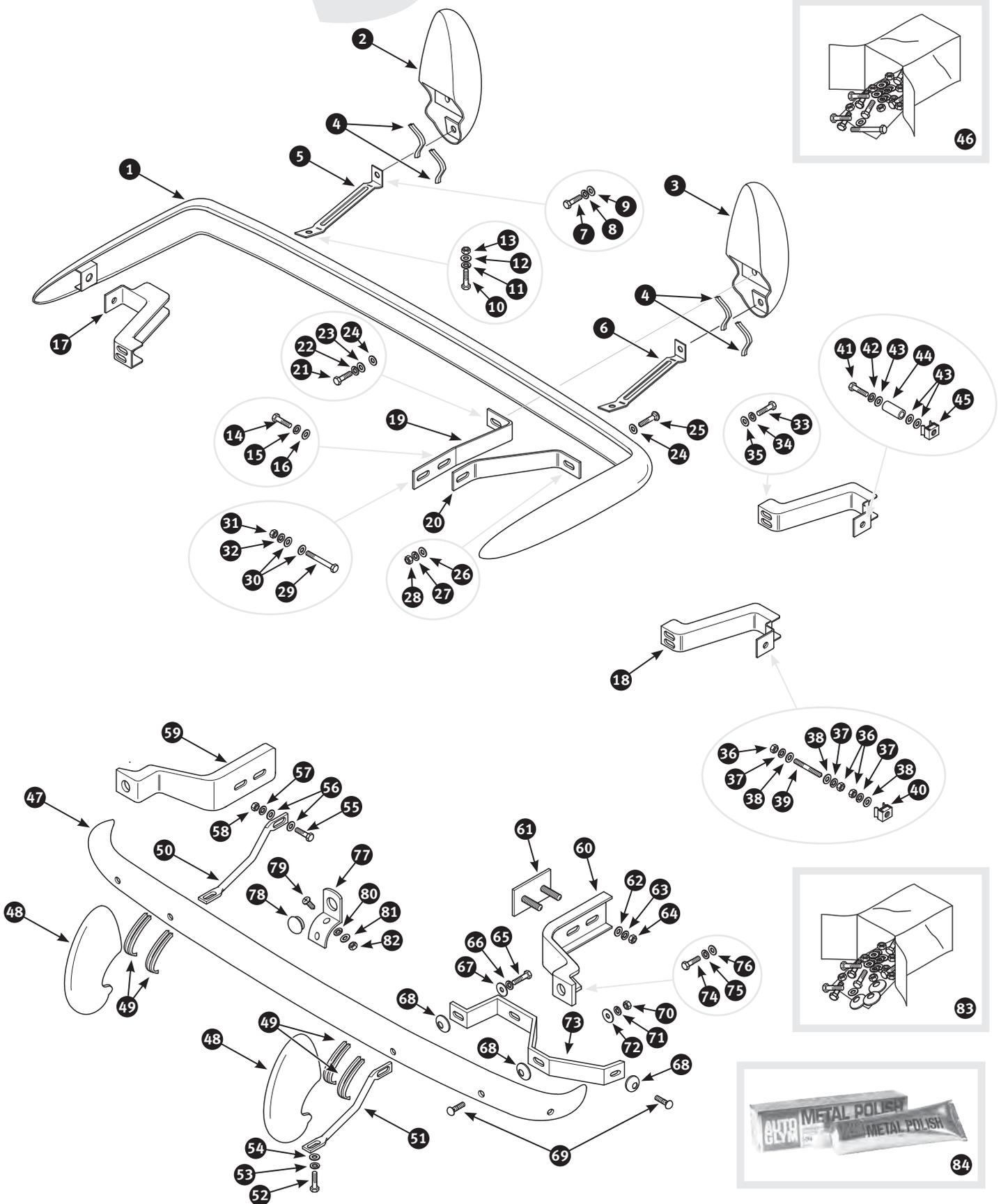

No	Part No	Description	Qty	Notes
51	204566	Stay LH front overrider to wheel arch	1	
52	212162	Screw stay to overrider	2	
53	212194	Spring washer	2	
54	212193	Plain washer	2	
55	2826	Screw stay to wheel arch	2	
56	212193	Plain washer	4	
57	212194	Spring washer	2	
58	2303	Nut	2	
59	297635	Extension RH front bumper bracket.	1	
60	301425	Extension LH front bumper bracket	1	
61	16561	Stud plate bumper extension to chassis.	2	
62	9671	Plain washer	4	
63	2051	Spring washer	4	
64	3073	Nut	4	
65	6516	Bolt front bumper to bumper bracket	2	
66	2051	Spring washer	2	
67	212195	Plain washer	2	
68	11409	Spacing washer front bumper to bumper bracket	6	
69	214671	Bolt with nut - front bumper to bumper bracket	4	
70	3073	Nut	4	
71	2051	Spring washer	4	
72	212195	Plain washer	4	
73	336479	Bumper bracket front.	2	
74	213888	Screw bumper bracket o extension	2	
75	2051	Spring washer	2	
76	212195	Plain washer	2	
77	16247	Guide plate starting handle - chromed.	1	
78	11299	Blanking plug guide plate.	1	
79	7763	Panhead screw - chromed	2	
80	7793	Plain washer	2	
81	212190	Spring washer	2	
82	215477	Nut	2	
83	338225	Fitting kit front bumper - 60 piece.	1	
84	700	Autoglym Metal Polish 75 g. tube	1	} Ask for our special catalogue.

Screw kit

800 pieces. Screws, washers, nuts and spring washers 1/4, 5/16 and 3/8" UNF yellow galvanised, Part no. 486713
zink plated, Part no. 336814

400 pieces, UNC
zink plated, Part no. 480661

200 pieces, BSF
zink plated, Part no. 295797



16.4

Bumpers

Bumpers - TR4A

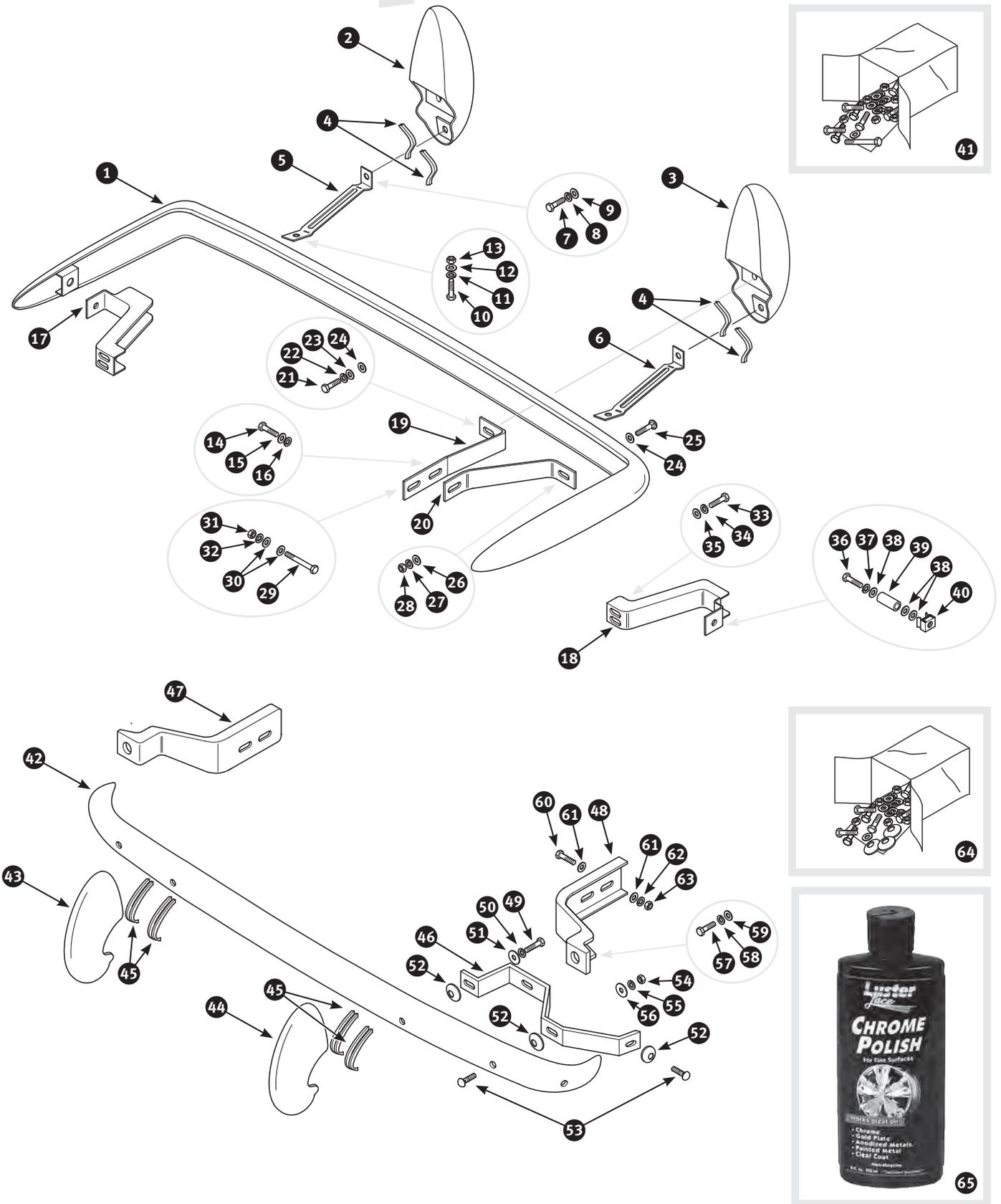

No	Part No	Description	Qty	Notes
1	12098	Bumper rear	1	
2	2528	Override RH rear.	1	} With hole for number plate lamp
3	2527	Override LH rear.	1	
4	202301	Rubber seal override to bumper.	4	
5	215074	Stay RH rear override	1	
6	215073	Stay LH rear override	1	
7	7893	Screw stay to override	2	
8	212194	Spring washer	2	
9	212193	Plain washer	2	
10	213886	Screw stay to chassis.	2	
11	212195	Plain washer	2	
12	2051	Spring washer	2	
13	3073	Nut	2	
14	213888	Screw bumper bracket to chassis	2	
15	2051	Spring washer	2	
16	212195	Plain washer	2	
17	20526	Chassis outrigger RH rear.	1	
18	257632	Chassis outrigger LH rear	1	
19	215071	Bumper bracket rear inner - new item	2	
19	204555	Bumper bracket rear inner - used item.	2	
20	215072	Bumper bracket rear outer - new item	2	
20	204562	Bumper bracket rear outer - used item	2	
21	213889	Bolt override to bracket	2	
22	2051	Spring washer	2	
23	212195	Plain washer	2	
24	11409	Spacing washer front bumper to bumper bracket	4	
25	214671	Bolt with nut - rear bumper to bumper bracket	2	
26	212195	Plain washer	2	
27	2051	Spring washer	2	
28	3073	Nut	2	
29	6540	Bolt bumper bracket to chassis.	2	
30	212195	Plain washer	4	
31	3073	Nut	2	
32	2051	Spring washer	2	
33	7898	Screw outrigger to chassis	4	
34	212194	Spring washer	4	
35	212195	Plain washer	4	
36	5327	Bolt	2	
37	2051	Spring washer	2	
38	212195	Plain washer	6	
39	11243	Distance tube	2	
40	9811	Captive nut	2	
41	338486	Fitting kit rear bumper - 76 piece	1	
42	481	Bumper front - chromed	1	
43	1721	Override RH front	1	
44	1722	Override LH front	1	
45	202301	Rubber seal override to bumper.	4	
46	1663	Bumper bracket front.	2	
47	296384	Extension RH front bumper bracket.	1	} New item
48	301031	Extension LH front bumper bracket	1	
47	203805	Extension RH front bumper bracket.	1	} Used item
48	203806	Extension LH front bumper bracket	1	
49	13642	Bolt override to bumper bracket	2	
50	2051	Spring washer	2	

16.4

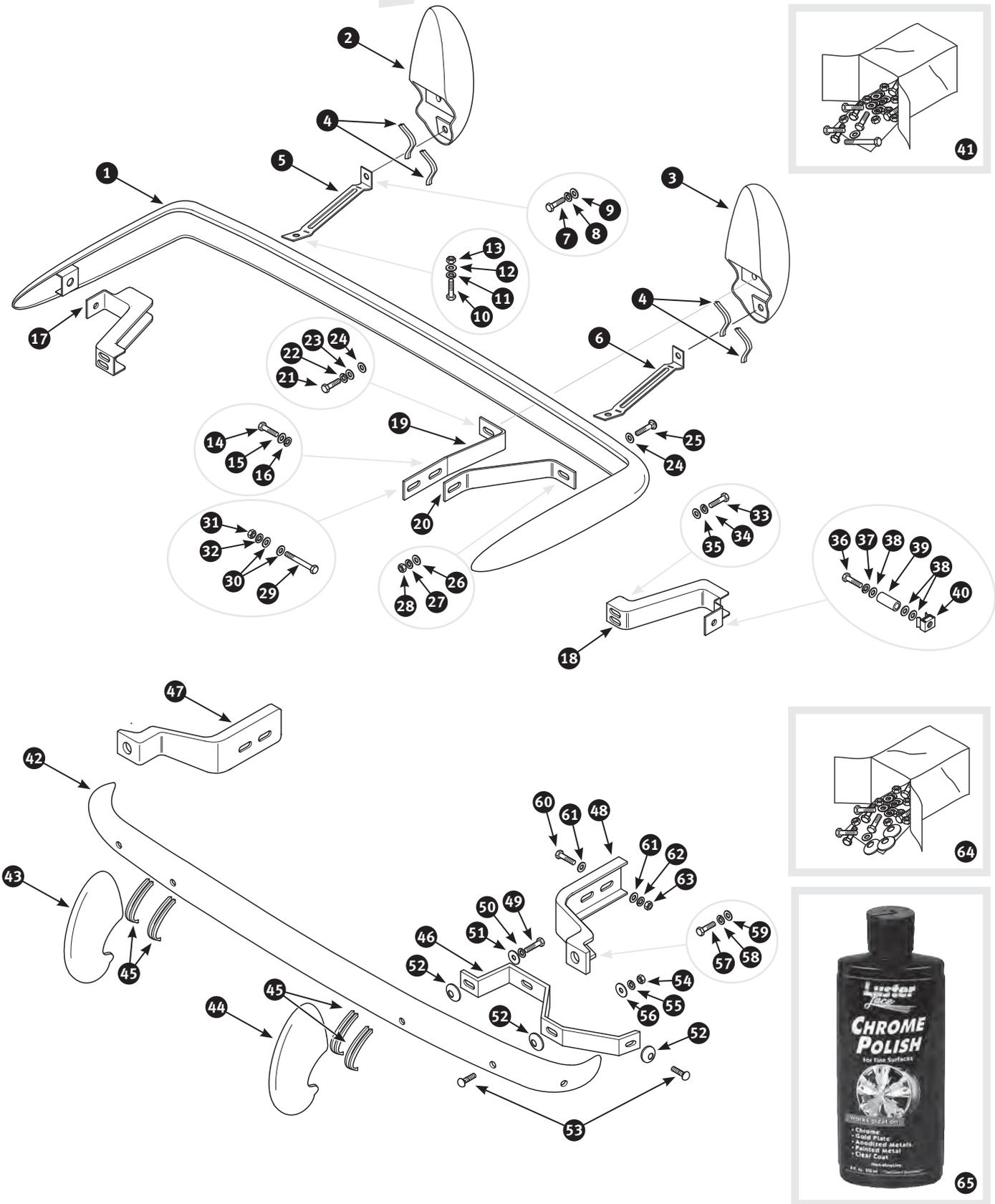

No	Part No	Description	Qty	Notes
51	3811	Plain washer	2	
52	11409	Spacing washer front bumper to bumper bracket	6	
53	214671	Bolt with nut - front bumper to bumper bracket	4	
54	3073	Nut	4	
55	2051	Spring washer	4	
56	212195	Plain washer	4	
57	3382	Bolt bumper bracket to extension	2	
58	2051	Spring washer	2	
59	212195	Plain washer	2	
60	9802	Bolt bumper extension to chassis	2	} Length: 2.3/4"
60	213892	Bolt bumper extension to chassis	2	
61	9671	Plain washer	8	
62	2051	Spring washer	4	
63	3073	Nut	4	
64	338229	Fitting kit front bumper - 54 piece.	1	
65	485449	Luster Lace Chrome polish 216 ml bottle	1	} Ask for our special catalogue.

Combination spanner set

made from forged from chrome vanadium steel. Comes with tool bag

6 piece: 3/8, 7/16, 1/2, 9/16, 5/8 & 3/4"
Part no. 204790

11 piece: 1/4, 5/16, 3/8, 7/16, 1/2, 9/16, 5/8, 11/16, 3/4, 13/16 & 7/8"
Part no. 311507

14 piece: 3/8, 7/16, 1/2, 9/16, 5/8, 11/16, 3/4, 13/16, 7/8, 15/16, 1, 1.1/16, 1.1/8 & 1.1/4"
Part no. 214943



17.1

Radiator grille | Radiator grille - TR2, TR3, TR3A and TR3B

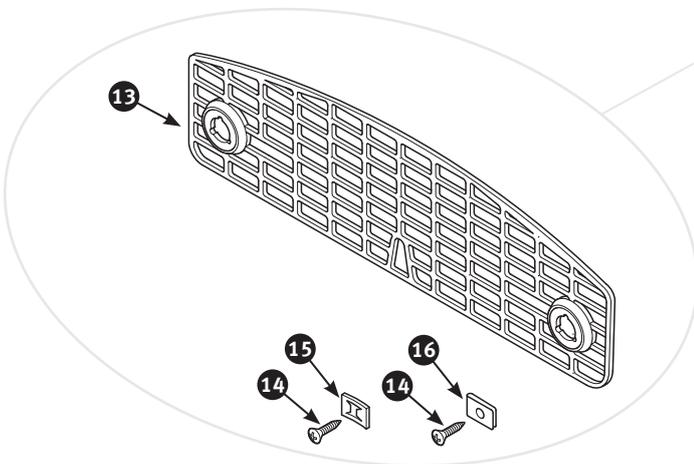
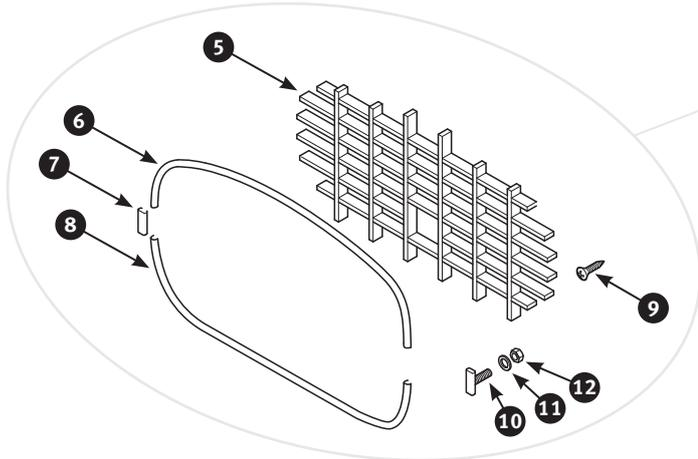
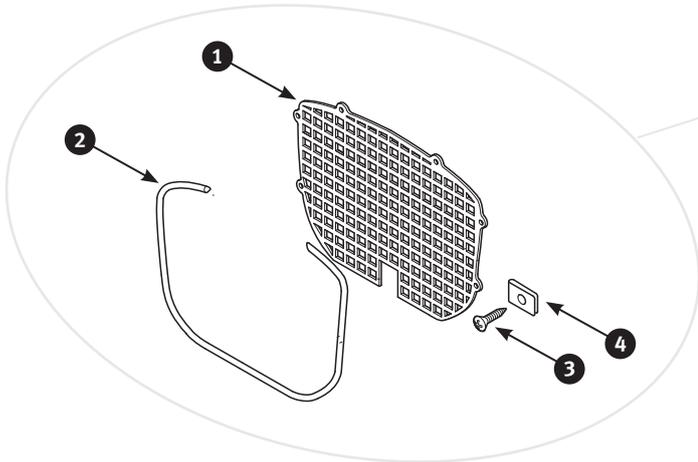
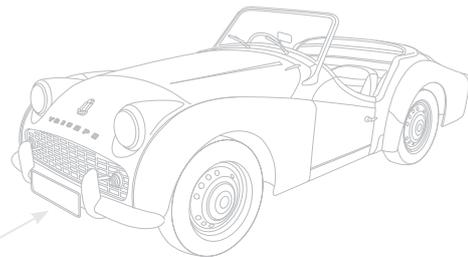
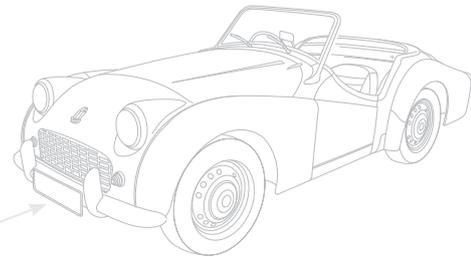
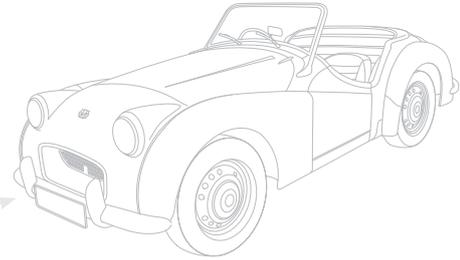

No	Part No	Description	Qty	Notes
1	200463	Radiator grille	1	TR2
2	288887	Chrome moulding radiator grille	1	
3	2024	Self tapping screw radiator grille to front shroud	8	
4	9658	Spire nut	8	TR3
5	1244	Radiator grille	1	
6	213947	Chrome moulding radiator grille - upper	1	
7	21368	Finishing clip grille mouldings.	2	
8	213948	Chrome moulding radiator grille - lower.	1	
9	16159	Self tapping screw radiator grille to front shroud	4	TR3A and TR3B
10	1870	Stud plate moulding to front shroud	9	
11	212190	Spring washer	9	
12	215477	Nut	9	
13	2541	Radiator grille	1	
14	17775	Self tapping screw radiator grille to front shroud	8	
15	3089	Spire nut - flat type	4	
16	9658	Spire nut - U-type	4	

Luster Lace Polishing strips
 ,narrow'. Content: 14 strips 1/2" wide
 Part no. 485441



17.2

Radiator grille

Radiator grille - TR4 and TR4A

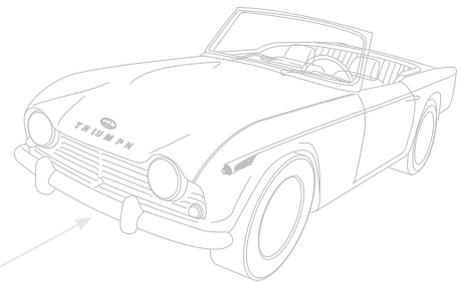
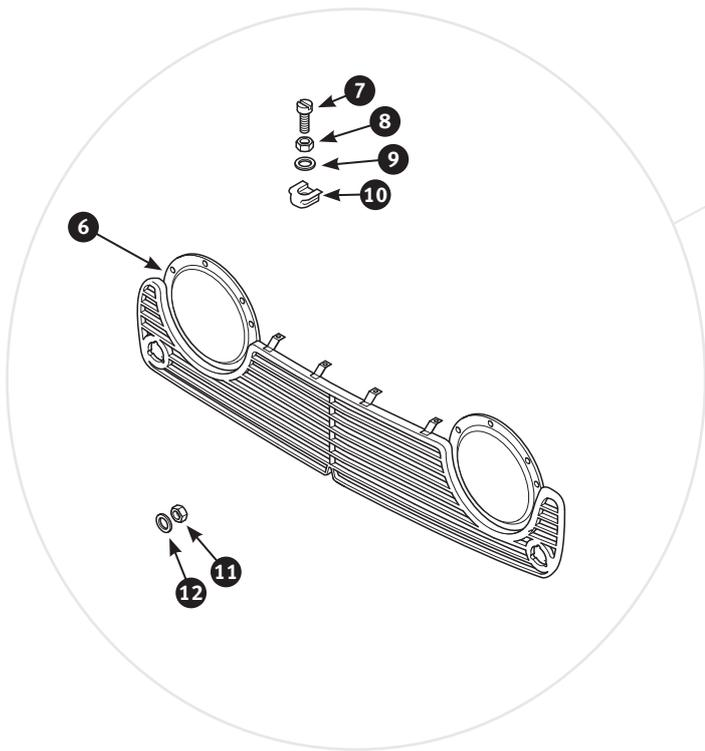
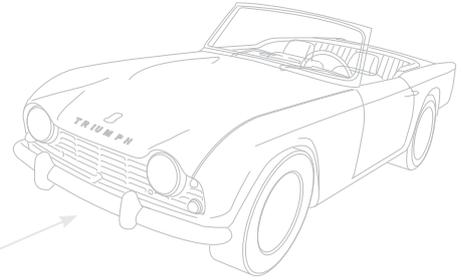
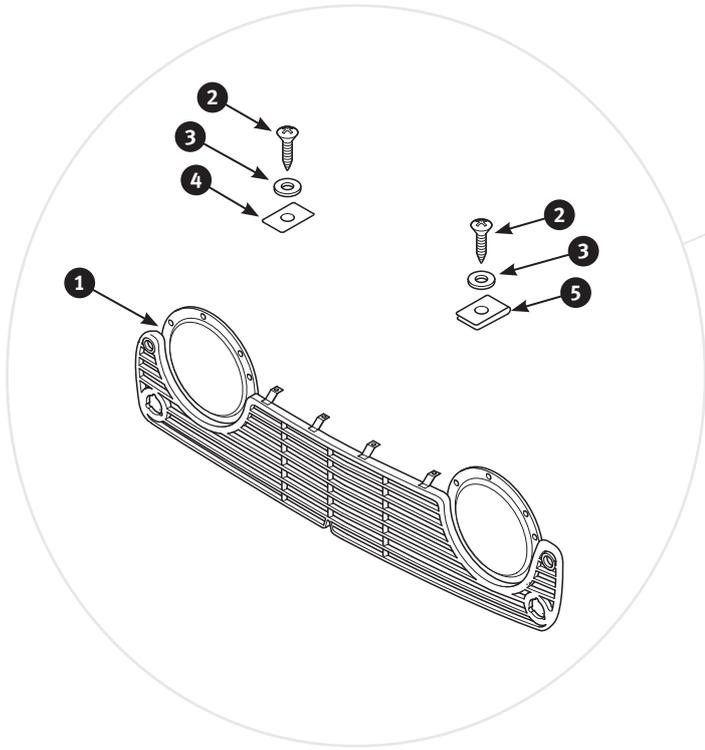

No	Part No	Description	Qty	Notes
1	19899	Radiator grille	1	TR4
2	3822	Self tapping screw radiator grille to upper front valance	6	
3	1717	Plain washer	6	
4	3089	Spire nut - flat type	2	
5	11404	Spire nut - U-type	4	
6	203910	Radiator grille	1	
7	10823	Panhead screw radiator grille to upper front valance.	2	TR4A
8	212190	Spring washer	2	
9	11166	Plain washer	2	
10	11149	Nut retained	2	
11	3783	Nyloc nut radiator grille to upper front valance.	2	
12	212189	Plain washer	2	
13	446830	Stainless steel spray 400 ml aerosol	1	

Leather straps

in black. Bonnet and boot lid/tailgate retaining.

Supplied in pairs

Part no.14883



18.1

Fittings and external trim parts

Bonnet fittings - TR2 to TS4228

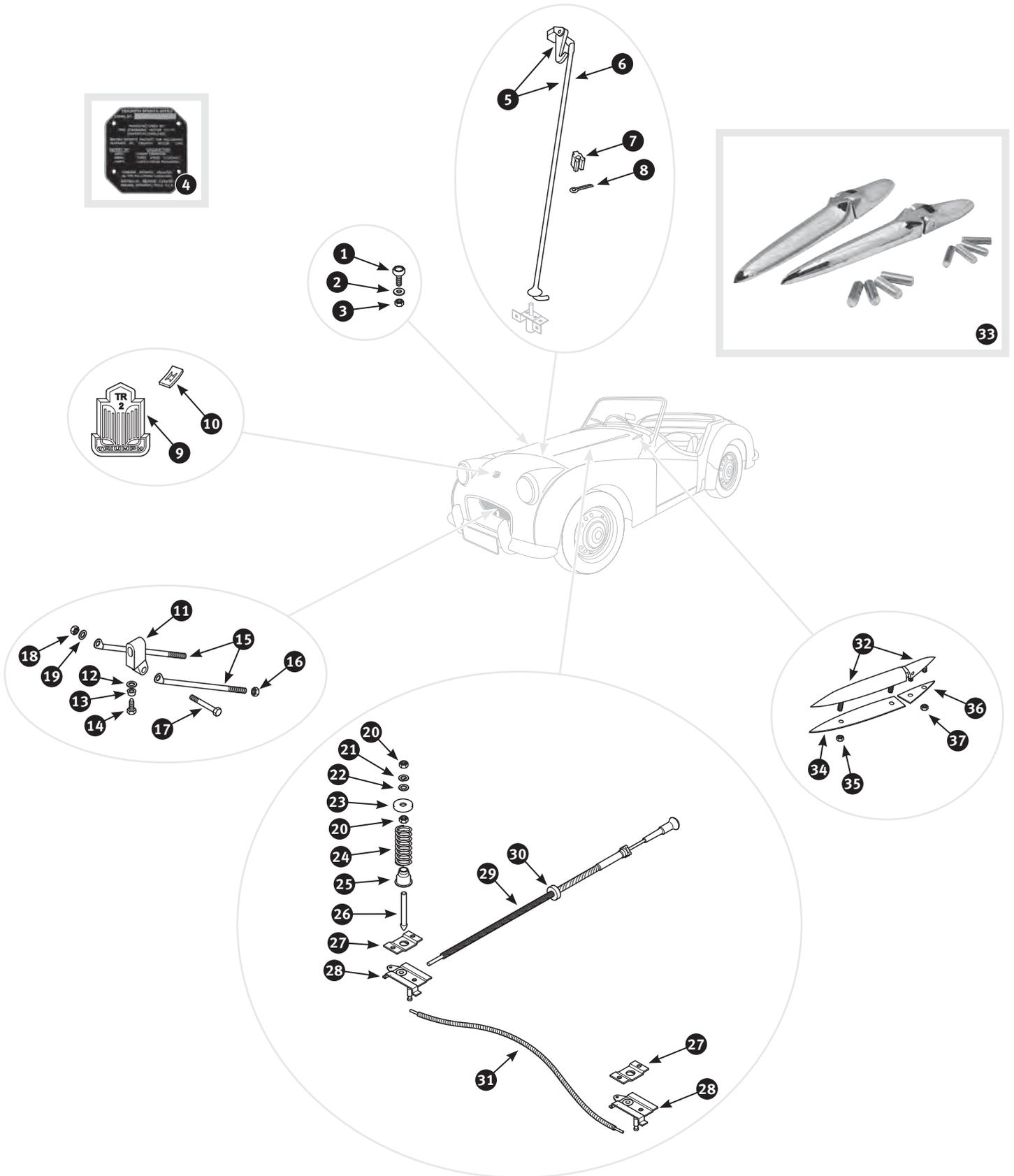

No	Part No	Description	Qty	Notes
1	11269	Rebound buffer bonnet	2	
2	2828	Nut	2	
3	7794	Plain washer	2	
4	2759	Chassis plate TR2	1	
no ill.	21454	Rivet chassis plate retaining	2	
5	9635	Bonnet stay with safety catch assembly	1	
6	10237	Safety catch separately	1	
7	8701	Rebound buffer bonnet stay	1	
8	7466	Split pin	1	
9	406	Medallion on front valance - „Triumph TR2“ in red and black	1	
10	7756	Spire nut medallion retaining	2	
11	18119	Guide starter handle	1	
12	7794	Plain washer	1	
13	212192	Spring washer	1	
14	3120	Pointed screw starter handle guide retaining	1	
15	20942	Stay starter handle guide	2	
16	7739	Nut stay to chassis	4	
17	4939	Bolt stay to starter handle guide	1	
18	2303	Nut	1	
19	212194	Spring washer	1	
20	3073	Nut	4	
21	2051	Spring washer	2	
22	212195	Plain washer	2	
23	293187	Cup washer bonnet lock	2	
24	293251	Spring bonnet lock	2	
25	293475	Thimble bonnet lock	2	
26	293593	Striker pin bonnet lock	2	
27	293856	Catch plate bonnet lock	2	
28	298479	Bonnet lock	2	
29	300519	Bonnet release cable - dashboard to bonnet lock	1	
30	26169	Grommet bonnet release cable	1	
31	297129	Bonnet release cable between bonnet locks	1	
32	16648	Hinge bonnet, LH	1	} Original style - un-plated
32	16649	Hinge bonnet, RH	1	
33	307198	Hinges bonnet. Supplied in pairs	1	} May replace original hinges
33	2515	Hinges bonnet - chromed. Supplied in pairs	1	
34	2487	Gasket hinge to bonnet	2	
35	3783	Nyloc nut hinge to bonnet	4	
36	3042	Gasket hinge to bulkhead	2	
37	2303	Nut hinge to bulkhead	4	



Swissvax Paint Rubber Set

Mineral based putty compound that will gently remove paint overspray, industrial and environmental contaminants. Paint Rubber is the basis for fine, slippery varnish surfaces and can / should be used before applying cleaner fluid. Including elastic putty clay bar, quick finish (quick detailing fluid).

Part no.297592



18.2

Fittings and external trim parts

Bonnet fittings - TR2 from TS4229, TR3, TR3A and TR3B

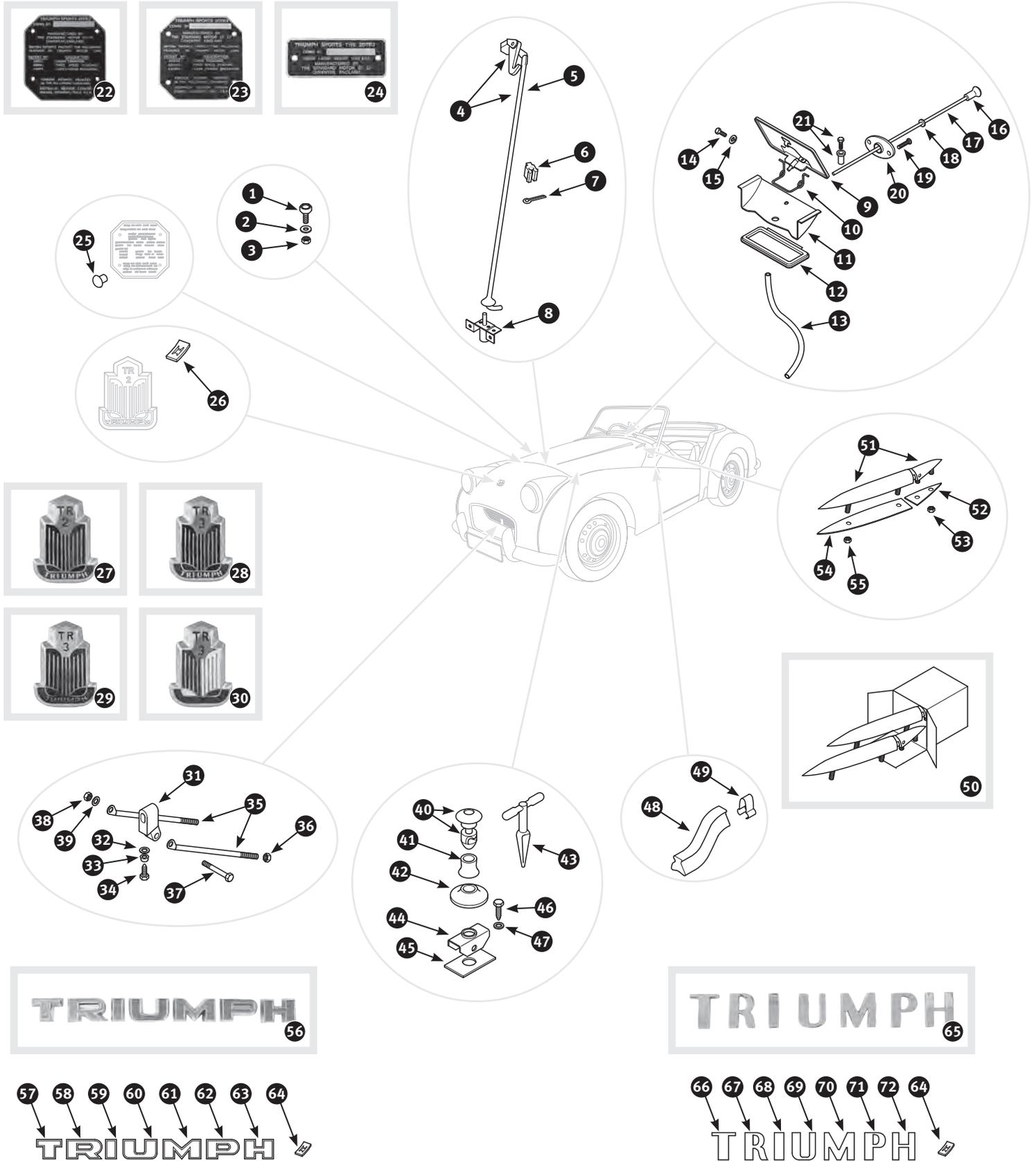

No	Part No	Description	Qty	Notes
1	11269	Rebound buffer bonnet	1	
2	2828	Nut	2	
3	7794	Plain washer	2	
4	9635	Bonnet stay with safety catch assembly.	1	
5	10237	Safety catch separately	1	
6	8701	Rebound buffer bonnet stay.	1	
7	3805	Split pin	1	
8	21367	Bracket bonnet stay.	1	
9	3757	Air flap with mechanism assembly.	1	} TR2 from TS6157, TR3, TR3A and TR3B
9	11254	Air flap separately	1	
10	3114	Spring air vent	1	
11	479653	Shelf panel vent lid	1	
12	2483	Seal air vent	1	
13	310418	Drain tube in vent tray.	1	
14	212139	Screw vent lid to bulkhead.	4	
15	212190	Spring washer	4	
16	3966	Knob air vent rod	1	
17	11533	Operating rod air vent	1	
18	26169	Grommet	1	
19	11320	Countersunk screw escutcheon to dashboard	2	
20	1826	Escutcheon air vent knob - epigram: ‚vent pull‘	1	
21	19467	Trunnion air vent rod.	1	
22	2759	Chassis plate	1	
23	2760	Chassis plate	1	
24	2761	Chassis plate	1	
25	21454	Rivet chassis plate retaining.	2	
26	7756	Spire nut medallion retaining	2	
27	406	Medallion on front valance - ‚Triumph TR2‘ in red and black	1	} TR2 } TR3 } TR3A to TS41873 } TR3A from TS41874 und TR3B
28	11316	Medallion on front valance - ‚Triumph TR3‘ in red and black	1	
29	111	Medallion on front valance - ‚TR3‘ in red and black	1	
30	115	Medallion on front valance - ‚TR3‘ in blue and white.	1	
31	18119	Guide starter handle	1	
32	7794	Plain washer	1	
33	212192	Spring washer	1	
34	3120	Pointed screw starter handle guide retaining	1	
35	20942	Stay starter handle guide.	2	
36	7739	Nut stay to chassis	4	
37	4939	Bolt stay to starter handle guide.	1	
38	2303	Nut	1	
39	212194	Spring washer	1	
40	105	Dzus fastener bonnet.	2	
41	392	Sleeve dzus fastener	2	
42	106	Locking washer dzus fastener.	2	
43	10280	Square key to secure bonnet	1	
44	414	Anchor plate with spring assembly - dzus fastener	2	
44	328589	Spring separately.	2	
45	2473	Shim dzus fastener anchor bracket	0	} Quantity as required
46	3120	Pointed screw	4	
47	212192	Spring washer	4	
48	201359	Rubber seal door to bulkhead	2	} TR2 from TS5251, TR3, TR3A and TR3B
49	2472	Retaining clip rubber seal to bulkhead.	14	
50	2515	Hinges bonnet - chromed. Supplied in pairs.	1	

18.2

Fittings and external trim parts

Bonnet fittings - TR2 from TS4229, TR3, TR3A and TR3B

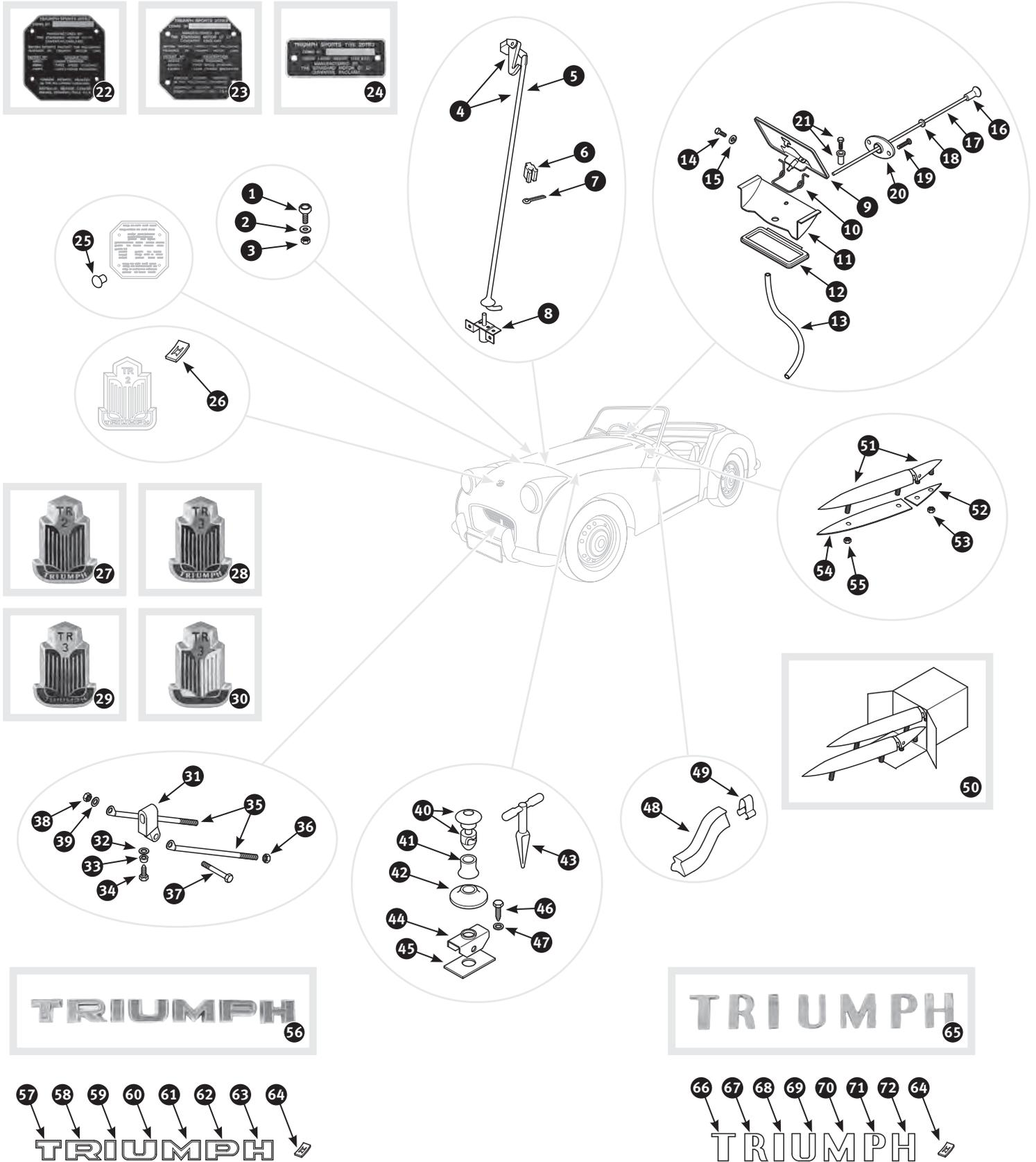

No	Part No	Description	Qty	Notes
51	10856	Hinge bonnet, LH - chromed.	1	
51	10857	Hinge bonnet, RH - chromed.	1	
52	2487	Gasket hinge to bonnet	2	
53	3783	Nyloc nut hinge to bonnet	4	
54	3042	Gasket hinge to bulkhead.	2	
55	2303	Nut hinge to bulkhead	4	
56	2261	Script ,Triumph' on front shroud	1	} TR3A to approx. TS72000 identify by ribbed face
57	452	Letter ,T' separately.	1	
58	2519	Letter ,R' separately.	1	
59	2520	Letter ,I' separately	1	
60	2521	Letter ,U' separately.	1	
61	2522	Letter ,M' separately	1	
62	2523	Letter ,P' separately.	1	
63	2524	Letter ,H' separately.	1	
64	3088	Spire nut for letters	14	
65	2932	Script ,Triumph' on front shroud	1	
66	453	Letter ,T' separately.	1	
67	1775	Letter ,R' separately.	1	
68	10281	Letter ,I' separately	1	
69	10282	Letter ,U' separately.	1	
70	10283	Letter ,M' separately	1	
71	10284	Letter ,P' separately.	1	
72	10667	Letter ,H' separately.	1	

Order free of charge:



Tools catalogue

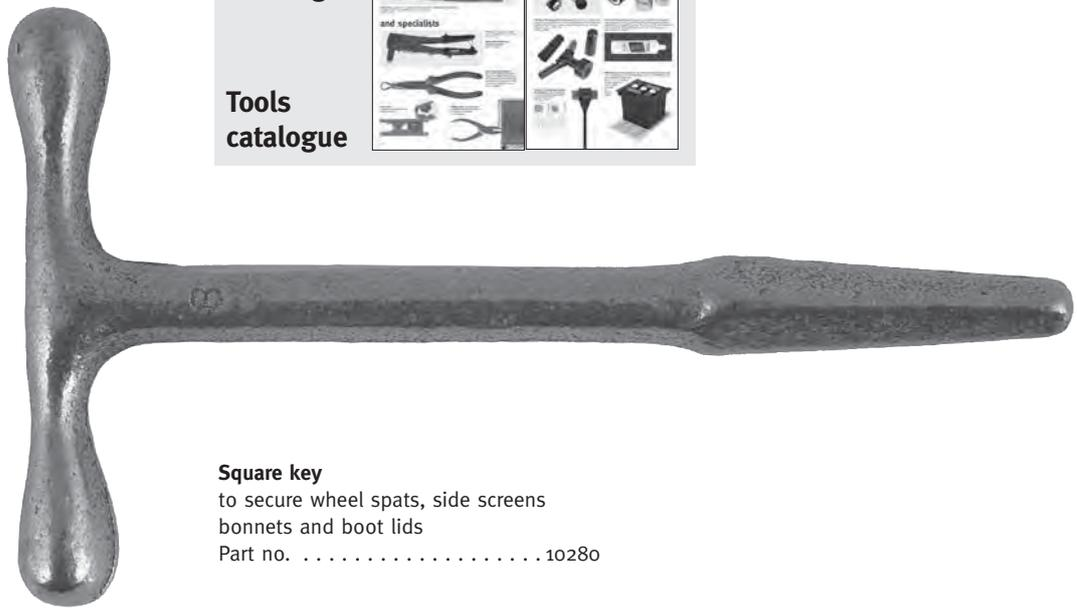

Square key
to secure wheel spats, side screens
bonnets and boot lids
Part no. 10280

18.3

Fittings and external trim parts

Bonnet fittings - TR4 and TR4A

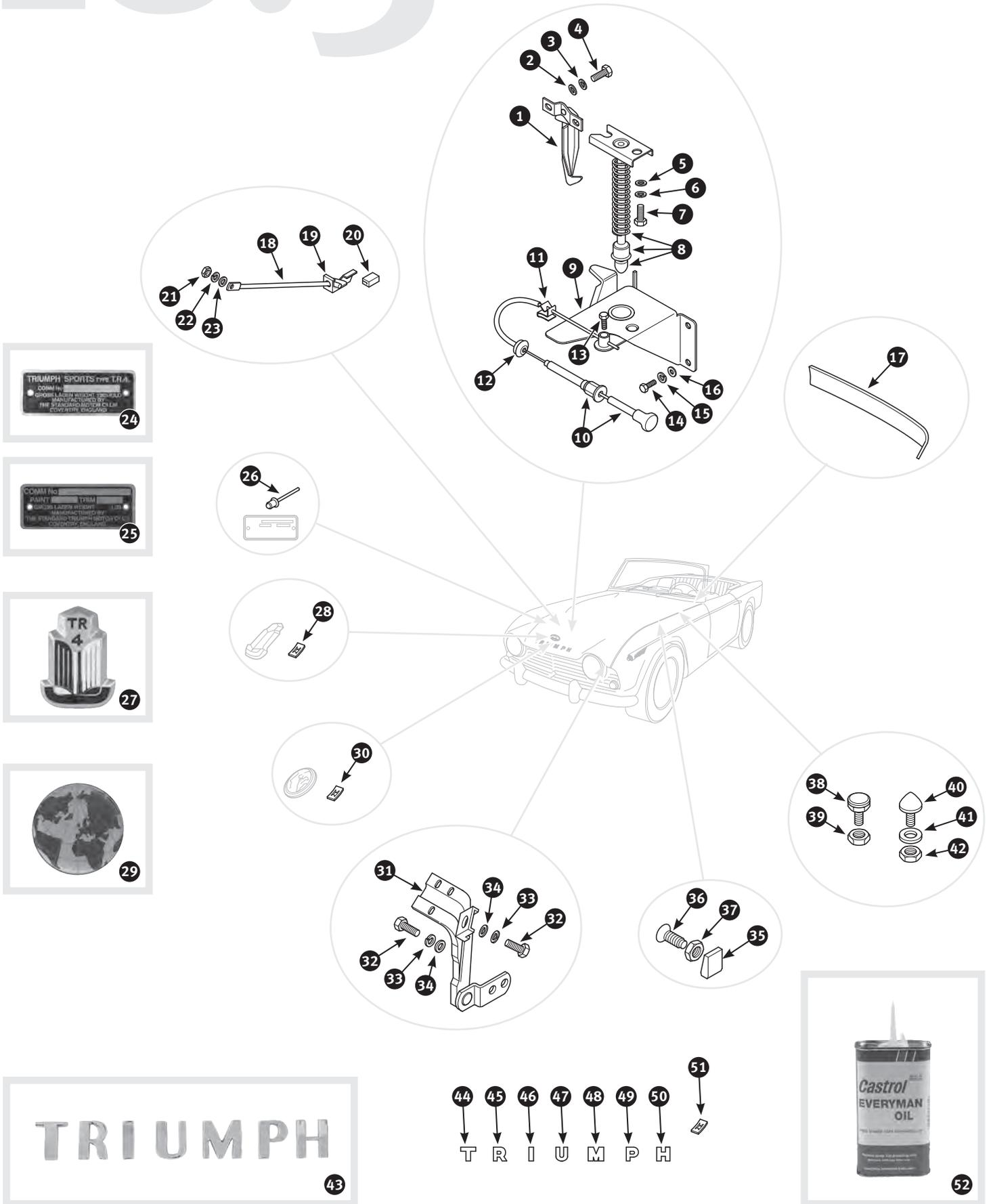

No	Part No	Description	Qty	Notes
1	300336	Safety catch bonnet	1	} TR4
2	7793	Plain washer	2	
3	212190	Spring washer	2	
4	201980	Screw safety catch to bonnet	2	
5	212191	Plain washer	2	
6	212192	Spring washer	2	
7	1912	Screw pin to bonnet	2	} TR4A type. Pin and bonnet lock may replace the original safety catch on TR4 models
8	1682	Pin bonnet lock with safety catch	1	
9	9560	Bonnet lock	1	
10	1094	Bonnet release cable with T-knob	1	
11	10452	Retaining clip bonnet release cable	1	
12	26169	Grommet bonnet release cable	1	
13	201980	Screw cable retaining	1	
14	1912	Screw bonnet lock to bulkhead	4	
15	212192	Spring washer	4	
16	212191	Plain washer	4	
17	5236	Rubber seal bonnet rear	1	
18	10306	Bonnet prop rod	1	
19	1666	Bracket bonnet prop rod	1	
20	3256	Rubber buffer bonnet prop rod	1	
21	2214	Nyloc nut prop rod to bonnet	1	
22	6306	Double coil washer	1	
23	7794	Plain washer	1	
24	2762	Chassis plate	1	
25	2763	Chassis plate characteristic: gross laden weight in LBS	1	
25	14495	Chassis plate characteristic: gross laden weight in kilos	1	
26	10085	Pop rivet chassis plate retaining	2	} TR4
27	134	Medallion on bonnet - ,TR4' in blue and white	1	
28	5772	Spire nut	2	} TR4A
29	458	Sticker on bonnet - ,Globe' in blue and red. May replace original enamel medaillon	1	
30	7754	Spire nut for original medaillon only	2	} New item
31	469170	Hinge bonnet, LH	1	
31	316753	Hinge bonnet, RH	1	
31	289932	Hinge bonnet, LH	1	} Used item
31	298667	Hinge bonnet, RH	1	
32	2826	Screw	10	} Alternatives
33	212194	Spring washer	10	
34	212193	Plain washer	10	
35	131	Rebound buffer bonnet	4	
35	317896	Polyurethane buffer bonnet	4	} TR4 to CT37689
36	18071	Self tapping screw bonnet buffer retaining	8	
37	5341	Cup washer	8	} TR4 from CT37690, TR4A
38	347928	Rubber buffer bonnet - flat type	2	
39	2303	Nut	2	
40	4763	Rubber buffer bonnet - pointed type	2	
41	5337	Plain washer	2	
42	7739	Nut	2	
43	2932	Script ,Triumph' on bonnet	1	
44	453	Letter ,T' separately	1	
45	1775	Letter ,R' separately	1	
46	10281	Letter ,I' separately	1	
47	10282	Letter ,U' separately	1	
48	10283	Letter ,M' separately	1	
49	10284	Letter ,P' separately	1	
50	10667	Letter ,H' separately	1	
51	3088	Spire nut for letters	14	} Please find further oils and lubricants in chapter 21.31
52	329103	Castrol Everyman Oil 250 ml bottle. High quality light lubricant for locks, hinges, linkages etc.	1	

18.4

Fittings and external trim parts

Boot lid fittings - TR2, TR3, TR3A and TR3B

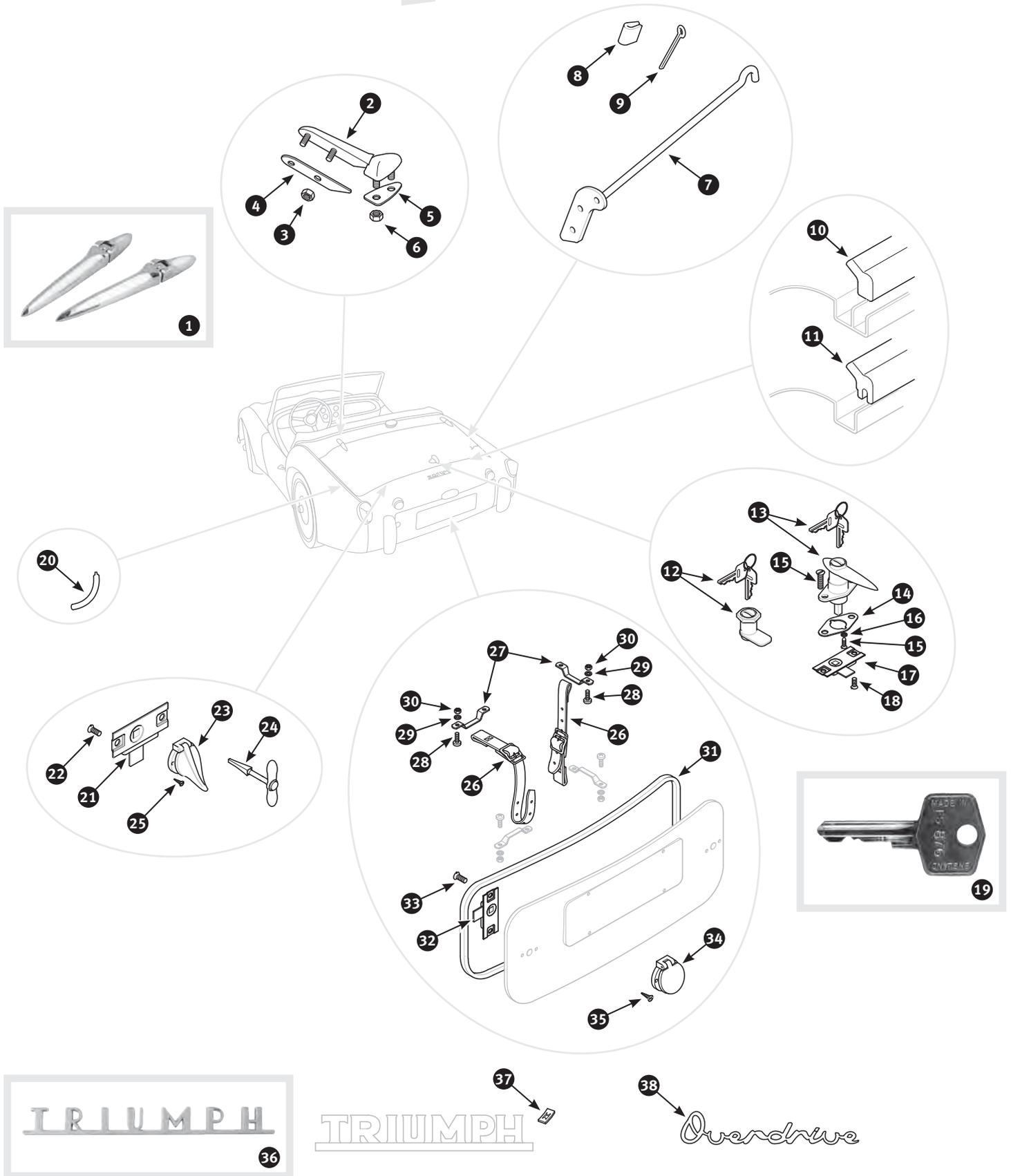

No	Part No	Description	Qty	Notes
1	307199	Hinges boot lid - un-plated. Supplied in pairs	1	} TR2
1	290305	Hinges boot lid - chromed. Supplied in pairs	1	
2	10859	Hinge boot lid LH - chromed.	1	} TR3, TR3A and TR3B will also fit TR2's
2	10858	Hinge boot lid RH - chromed	1	
3	2487	Gasket hinge to boot lid	2	
4	2828	Nut hinge to boot lid.	4	
5	3042	Gasket hinge to rear decking panel.	2	
6	2303	Nut hinge to rear decking panel	4	
7	3756	Boot lid stay	1	
8	8701	Rebound buffer boot lid stay	1	
9	7466	Split pin	1	
10	417	Sealing rubber boot lid	1	} TR2, TR3, TR3A to TS60000
11	2503	Sealing rubber boot lid	1	
12	18252	Boot lock with 2 keys assembly	1	} TR2 and TR3
13	419	Boot lock with handle and 2 keys assembly.	1	} TR3A and TR3B
14	20935	Gasket boot lock	1	
15	11320	Countersunk screw handle retaining	3	
16	8123	Shakeproof washer	1	
17	4917	Latch boot lid centre	1	
18	14750	Countersunk screw latch to boot lid	2	
19	6339	Key key code: FS.	1	} To identify the correct boot lock key for your vehicle, add the three-digit combination to your key code to, i. e. FS876
19	329195	Key key code: FA.	1	
19	299474	Key key code: FT.	1	
20	2471	Drain tube boot aperture surround	2	
21	4916	Latch boot lid, LH side.	1	} TR2 and TR3
21	4917	Latch boot lid, LH side.	1	
22	14750	Countersunk screw latch to boot lid	4	
23	892	Escutcheon boot lock.	2	
24	10280	Square key to secure boot lid.	1	
25	2710	Countersunk screw	4	
26	19292	Strap spare wheel and tools.	1	
27	301217	Staple	4	
28	7763	Panhead screw	8	
29	214403	Shakeproof washer	8	
30	215477	Nut	8	
31	388	Rubber seal spare wheel cover	1	
32	4916	Latch spare wheel cover, LH side.	1	
32	4917	Latch spare wheel cover, RH side	1	
33	14750	Countersunk screw	4	
34	1899	Escutcheon spare wheel latch.	2	
35	2710	Countersunk screw	4	
36	416	Script ,Triumph' on rear shroud.	1	} TR3A und TR3B
37	3088	Spire nut for script	3	
38	12931	Script ,Overdrive' on boot lid	1	

18.5

Fittings and external trim parts Boot lid fittings - TR4 and TR4A

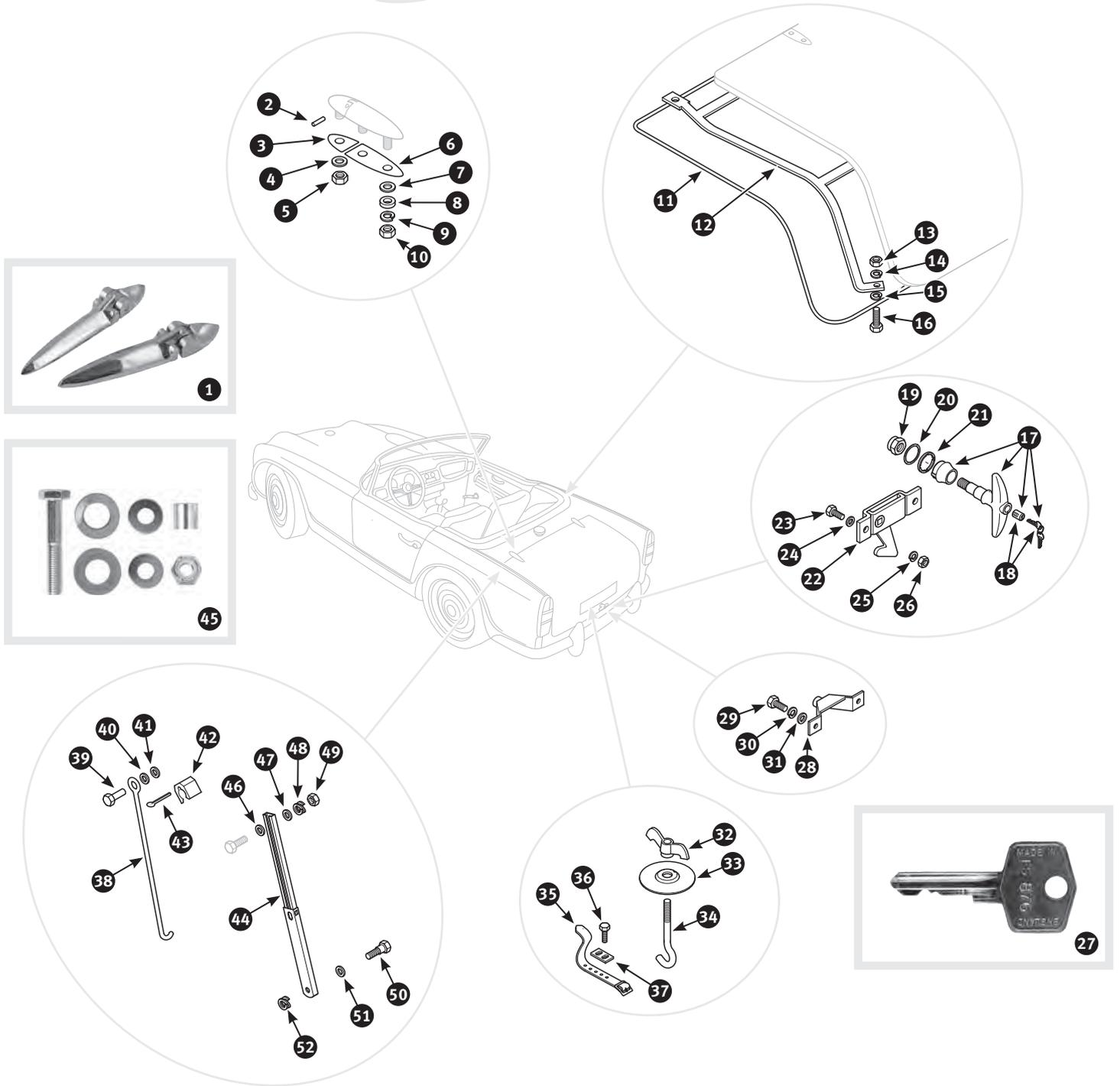

- 54 55 56 57 58 59 60 61

T R I U M P H

TRIUMPH 53
- 63

TR4

TR4 62
- 65

A

A 64
- 67

TRS

TRS 66
- 68

Overdrive

Overdrive 68

No	Part No	Description	Qty	Notes
1	16468	Hinges boot lid - chromed	1	} Supplied in pairs
2	337983	Pin boot lid hinge	2	
3	2498	Gasket hinge to rear decking panel	2	
4	3241	Plain washer	2	
5	7455	Nyloc nut hinge to rear decking panel	2	
6	2497	Gasket hinge to boot lid	2	
7	7794	Plain washer - large	2	
8	12821	Plain washer - small	2	
9	212192	Spring washer	4	
10	2828	Nut hinge to boot lid	4	
11	1681	Sealing rubber boot lid	1	
12	480198	Support rail boot lid	1	
13	2828	Nut	2	
14	10740	Plain washer	2	
15	212192	Spring washer	2	
16	3072	Screw support rail to boot lid	2	
17	1608	Boot lock with 2 keys	1	} With handle and locking barrel assembly
18	2982	Locking barrel with 2 keys	1	
19	212451	Nyloc nut	1	
20	212191	Plain washer	1	
21	10439	Gasket boot handle	1	
22	2535	Latch boot lock	1	
23	214337	Panhead screw	2	
24	7793	Plain washer	2	
25	212190	Spring washer	2	
26	215477	Nut	2	
27	6339	Key key code: FS	1	} To identify the correct boot lock key for your vehicle, add the three-digit combination to your key code to, i. e. FS876
27	329195	Key key code: FA	1	
27	299474	Key key code: FT	1	
28	10355	Catch plate boot lock	1	
29	214337	Panhead screw	2	
30	212190	Spring washer	2	
31	7793	Plain washer	2	
32	3116	Wing nut spare wheel retaining	1	
33	2231	Clamp plate spare wheel	1	
34	1234	Hook spare wheel retaining	1	
35	18096	Leather strap with buckle - tool roll	1	
36	10478	Panhead screw	2	
37	215414	Bracket for tool roll strap	1	
38	300805	Boot lid stay	1	} TR4 to CT5642
39	20816	Clevis pin boot lid stay	1	
40	7794	Plain washer	1	
41	300829	Retaining clip	1	
42	8701	Rebound buffer boot lid stay	1	} TR4 from CT5643, TR4A
43	7466	Split pin	1	
44	10252	Boot lid stay	1	
45	320470	Fitting kit boot lid stay, upper	1	
46	7794	Plain washer thin - separately	2	
47	12821	Plain washer thick - separately	1	
48	6306	Double coil washer separately	1	
49	2214	Nyloc nut separately	1	
50	9637	Bolt boot lid stay, lower	1	
51	12821	Plain washer	1	
52	6306	Double coil washer	1	

18.5

Fittings and external trim parts Boot lid fittings - TR4 and TR4A

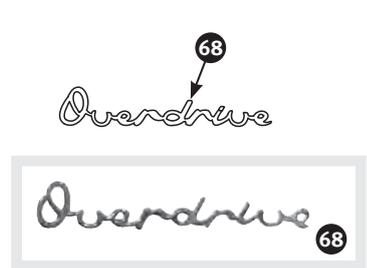
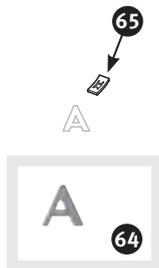
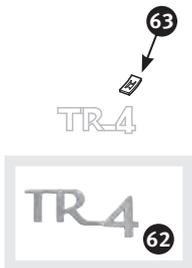
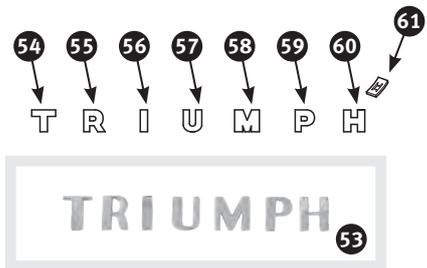
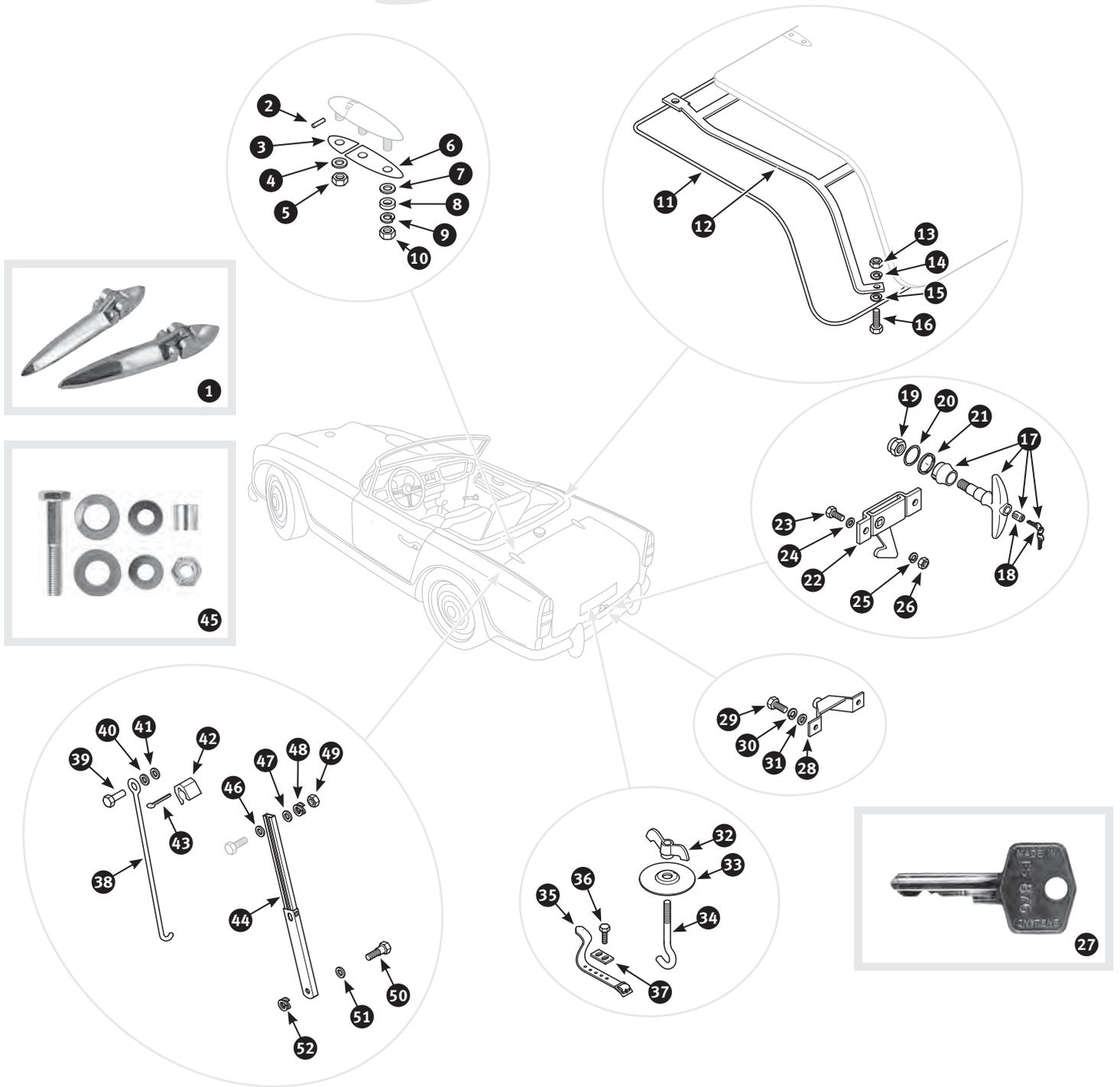

No	Part No	Description	Qty	Notes
53	2932	Script ,Triumph' on boot lid	1	
54	453	Letter ,T' separately	1	
55	1775	Letter ,R' separately	1	
56	10281	Letter ,I' separately	1	
57	10282	Letter ,U' separately	1	
58	10283	Letter ,M' separately	1	
59	10284	Letter ,P' separately	1	
60	10667	Letter ,H' separately	1	
61	3088	Spire nut for letters	14	
62	424	Script ,TR4' on boot lid	1	
63	3088	Spire nut for script	2	
64	428	Letter ,A' on boot lid	1	} TR4A
65	3088	Spire nut for letter	1	
66	429	Script ,IRS' on boot lid	1	} TR4A IRS
67	1914	Blind fix for script	2	
68	12931	Script ,Overdrive' on boot lid	1	

Order free of charge:

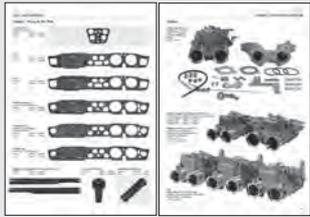

Tuning catalogue

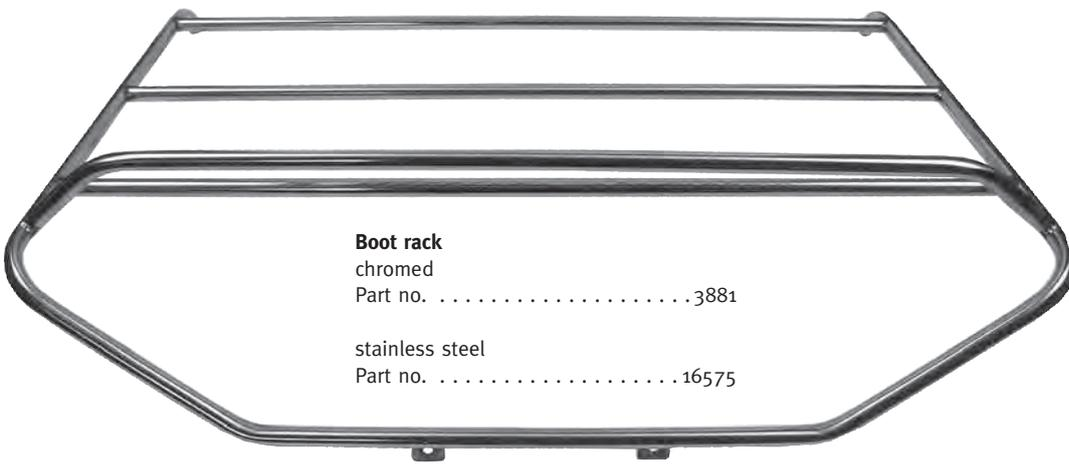

Boot rack
 chromed
 Part no. 3881

stainless steel
 Part no. 16575

18.6

Fittings and external trim parts

Door hinges and door seals - TR2, TR3, TR3A and TR3B

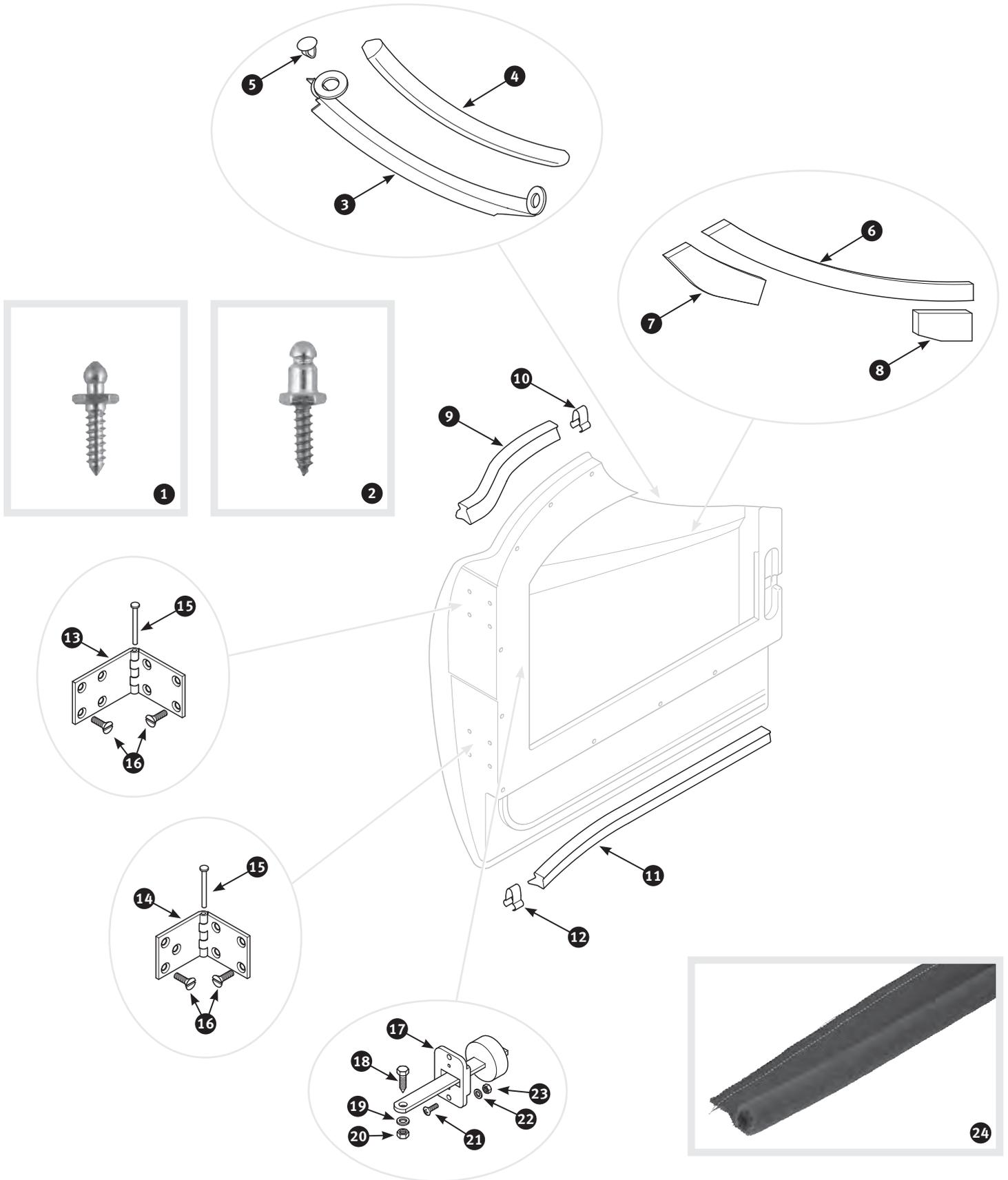

No	Part No	Description	Qty	Notes
1	21292	Tenax peg - self tapping	8	} TR2 to TS5255
2	11416	Lift the dot peg - self tapping	8	
3	20406	Capping LH door - steel	1	} For further information see chapter 18.10
3	20407	Capping RH door - steel	1	
4	18925	Rubber core door capping	2	
5	12089	End cap door capping - chromed	4	
6	300810	Wooden rail LH door top	1	} TR3A and TR3B
6	300811	Wooden rail RH door top	1	
7	475630	Wooden block side screen support, front	2	} TR2 and TR3, TR3A to TS60000
8	300749	Wooden block side screen support, rear	2	
7	300785	Wooden block side screen support, front	2	} TR3A from TS60001, TR3B
8	300786	Wooden block side screen support, rear	2	
9	201359	Rubber seal door to bulkhead	2	} TR2 from TS5251, TR3, TR3A and TR3B
10	2472	Retaining clip rubber seal to bulkhead	14	
11	415	Rubber seal door, lower	2	} TR2 and TR3, TR3A to TS60000
12	2472	Retaining clip rubber seal to door	28	
13	26450	Door hinge LH door, upper	1	
13	26449	Door hinge RH door, upper	1	
14	26452	Door hinge LH door, lower	1	
14	26451	Door hinge RH door, lower	1	
13	4812	Door hinge LH door, upper	1	
13	4808	Door hinge RH door, upper	1	
14	4646	Door hinge LH door, lower	1	
14	4647	Door hinge RH door, lower	1	
15	17975	Pin door hinge	4	} TR3A from TS60001, TR3B
16	3103	Pointed screw door hinge	30	
17	18205	Door check strap	2	
18	3120	Pointed screw door check strap to ‚A‘ post	2	
19	212192	Spring washer	2	
20	2828	Nut	2	
21	7772	Panhead screw door check strap to door	4	
22	212190	Spring washer	4	
23	215477	Nut	4	
24	191	Furflex door seal black	3	} Supplied per metre
24	318269	Furflex door seal red	3	
24	205728	Furflex door seal navy blue	3	
24	226137	Furflex door seal tan	3	



Silicone spray

This spray was invented by the mold release technology. Formulated for use on metal and non-metal surfaces, leaves a dry lubricating film, prevents rubber cracking and drying, displaces moisture. Perfect protection for hood frames, door glass seals and much more..., 400 ml aerosol

Part no. 338785

18.7

Fittings and external trim parts

Door hinges and door seals - TR4 and TR4A

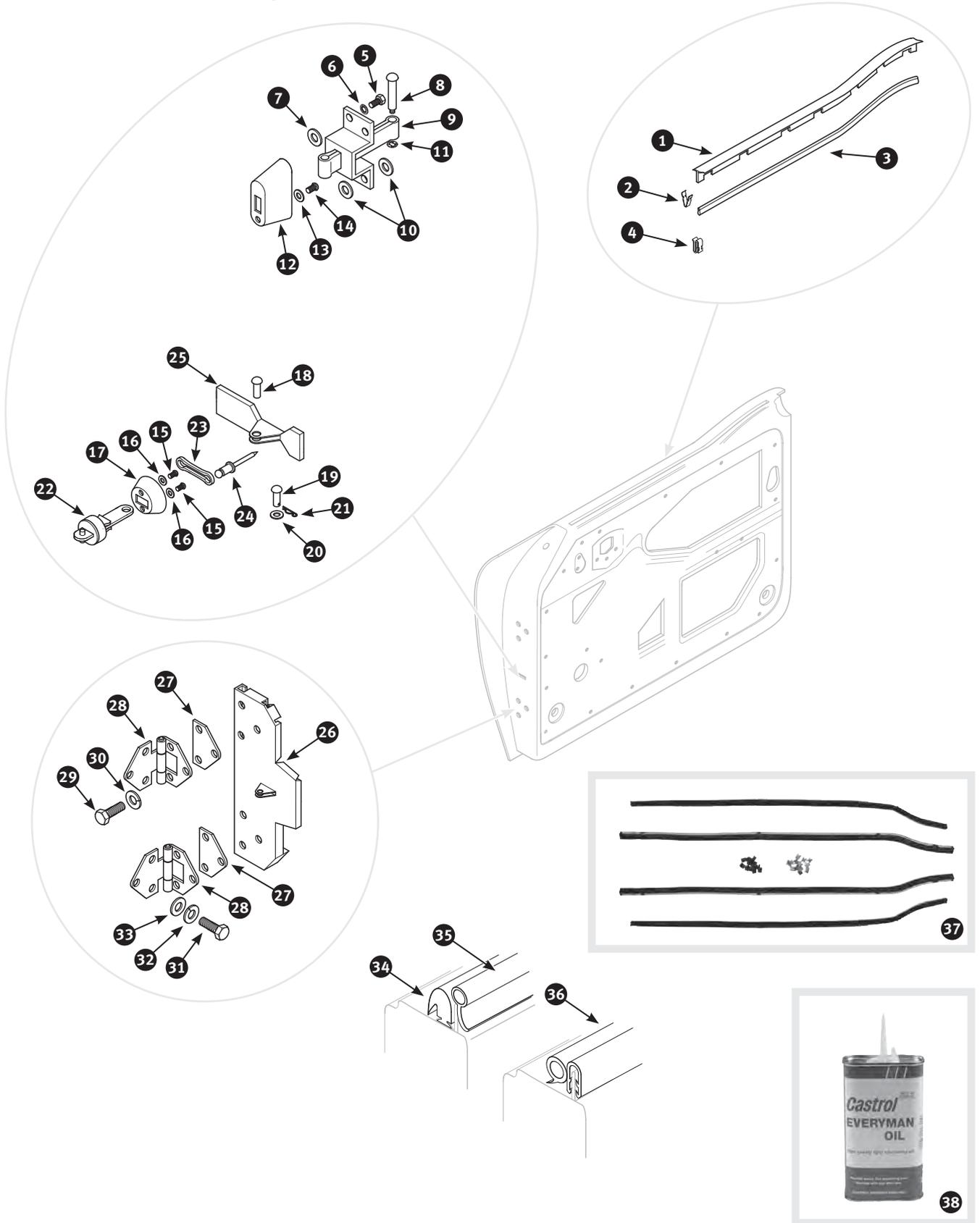

No	Part No	Description	Qty	Notes	
1	26272	Door glass seal LH outer	1		
1	26273	Door glass seal RH outer	1		
2	1891	Retaining clip outer door glass seal.	14		
3	26270	Door glass seal LH inner	1		
3	168	Door glass seal RH inner	1		
4	1932	Retaining clip inner door glass seal.	14		
5	7884	Screw door check strap to ,A' post	6	} TR4 to CT22343	
6	209089	Shakeproof washer internal star	6		
7	2831	Plain washer	6		
8	300790	Clevis pin door check strap	2		
9	16253	Door check strap LH door.	1		
9	26175	Door check strap RH door	1		
10	7793	Plain washer	8		
11	300828	Retaining clip	2		
12	16274	Gaiter door check strap	2		
13	7793	Plain washer	4		
14	10478	Panhead screw	4		
15	4163	Self tapping screw	4		
16	19383	Plain washer	4		
17	120	Gaiter door check strap	2		
18	5618	Rivet check strap to door.	2	} TR4 from CT22344, TR4A	
19	16577	Clevis pin check strap to door, may replace rivet 5618	2		
20	212191	Plain washer	2		
21	3304	Retaining clip	2		
22	1920	Door check strap	2		
23	1678	Clamp door check strap - fixed on ,A' post.	2		
24	7064	Pop rivet	4		
25	312804	Bracket door check strap - welded to ,A' post	2		
26	20842	Reinforcement LH door hinge	1		} TR4 to CT22343
26	20843	Reinforcement RH door hinge	1		
26	300799	Reinforcement LH door hinge	1	} TR4 from CT22344, TR4A	
26	300800	Reinforcement RH door hinge	1		
27	10449	Packing piece door hinge	0	} Quantity as required	
28	445	Door hinge	4		
29	212162	Screw door hinge to door.	12		
30	212194	Spring washer	12		
31	7893	Screw door hinge to ,A' post	12		
32	212194	Spring washer	12		
33	7795	Plain washer	12		
34	1832	Door seal outer, black nylon.	2	} Cars with soft top. Use if the door seal retainer is still fitted	
35	300763	Furflex door seal inner, black	2		
35	298944	Furflex door seal inner, red.	2		
35	300764	Door seal inner, blue	2		
34	300463	Door seal outer, black nylon.	2	} Cars with surrey top. Use if the door seal retainer is still fitted	
35	10250	Furflex door seal inner, black	2		
35	300761	Furflex door seal inner, red.	2		
35	300762	Furflex door seal inner, blue	2		
36	3840	Furflex door seal black.	2	} May replace genuine door seals and can be used when no retainer is fitted	
37	213173	Door glass seal kit contains 2 inner and 2 outer door glass seals and 28 retaining clips	1		
38	329103	Castrol Everyman Oil 250 ml bottle. High quality light lubricant for locks, hinges, linkages etc.	1	} Please find further oils and lubricants in chapter 21.31	

18.8

Fittings and external trim parts

Door locks and handles - TR2, TR3, TR3A and TR3B

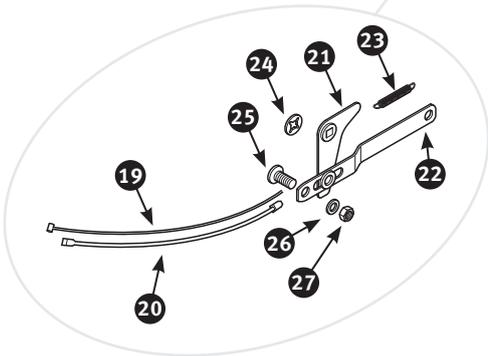
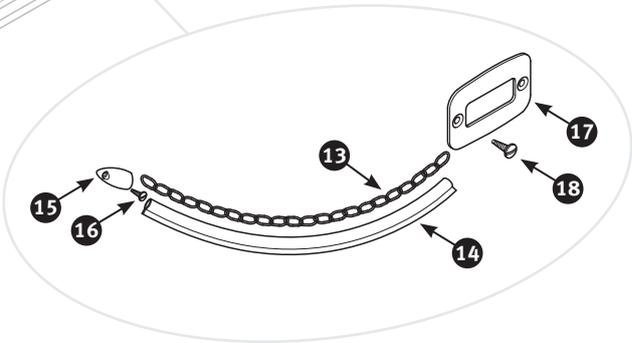
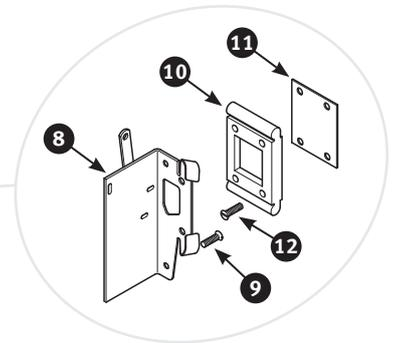
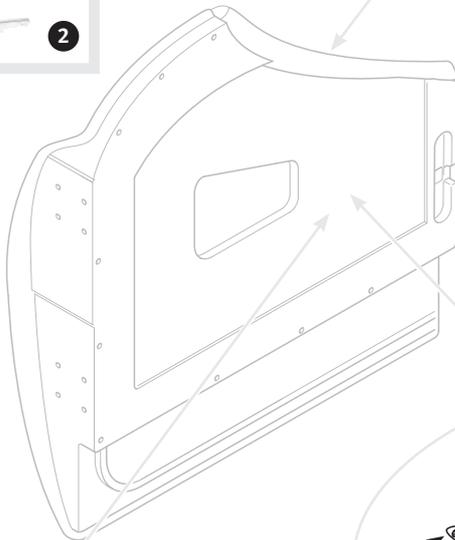
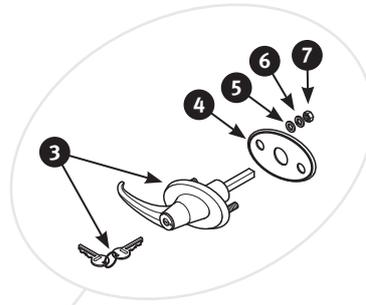

No	Part No	Description	Qty	Notes
1	4921	Private lock set - contains exterior door handles with lock set, cubby box lock, ignition tumbler, boot handle with barrel and matched pair of keys	1	TR3A and TR3B
2	338036	Private lock set - contains exterior door handles with lock set and matched pair of keys	1	
3	1606	Door handle exterior, with lock and key assembly.	2	
4	20935	Gasket door lock	2	
5	7793	Plain washer	4	
6	212190	Spring washer	4	
7	215477	Nut	4	
8	4327	Door lock LH door	1	Late TR3A type. Fits all applications when used with the original cable and fittings
8	4326	Door lock RH door	1	
9	12497	Countersunk screw door lock to door - original style.	8	Alternatives
9	303161	Countersunk screw door lock to door - replacement with cross slot	8	
10	1365	Lock striker on ,B' post	2	Alternatives
11	21429	Packing piece lock striker	2	
12	12497	Countersunk screw lock striker to ,B' post - original style	8	
12	303161	Countersunk screw lock striker to ,B' post - replacement with cross slot	8	
13	366776	Chain door pull	2	TR2 and TR3
14	290585	Slip cover in black, door pull chain	2	
15	300748	Finisher door pull cable, front.	2	
16	20985	Wood screw finisher to door panel	2	
17	5593	Escutcheon door lock lever.	2	
18	5692	Self tapping screw escutcheon to door panel	4	
19	300297	Control cable inner - door pull	2	TR3A and TR3B
20	20987	Slip cover in black - door pull cable	2	
21	20845	Lever door handle to lock remote control	2	
22	297394	Link LH door lock remote control	1	
22	305720	Link RH door lock remote control	1	
23	323319	Return spring door lock remote control	2	
24	294005	Retaining clip return spring.	2	
25	450340	Screw cable attachment	2	
26	212192	Spring washer	2	
27	2828	Nut	2	
28	6339	Key key code: FS.	1	TR3A and TR3B. To identify the correct door lock key for your vehicle, add the three-digit combination to your key code to, i. e. FS876
29	299474	Key key code: FT.	1	
30	329195	Key key code: FA.	1	

Knipex Circlip pliers

130 mm long, for internal circlips
from 8 to 13 mm, bent

Part no.482003

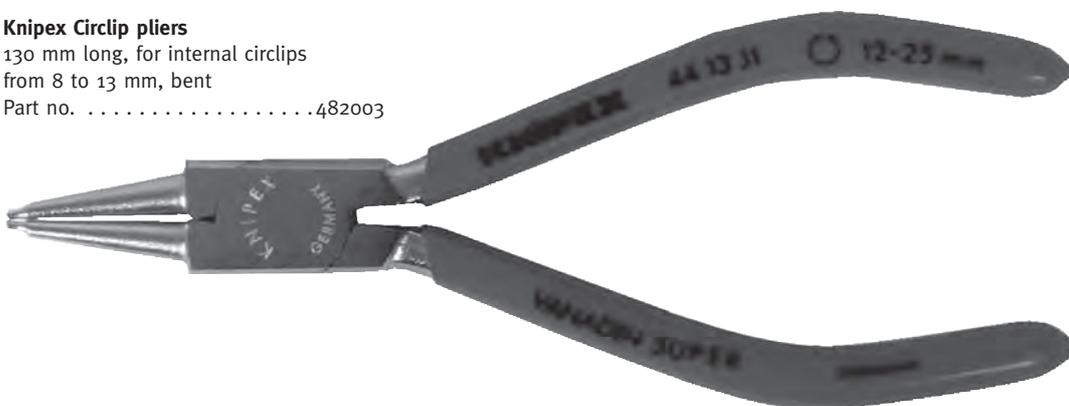

18.9

Fittings and external trim parts

Door locks and handles - TR4 and TR4A

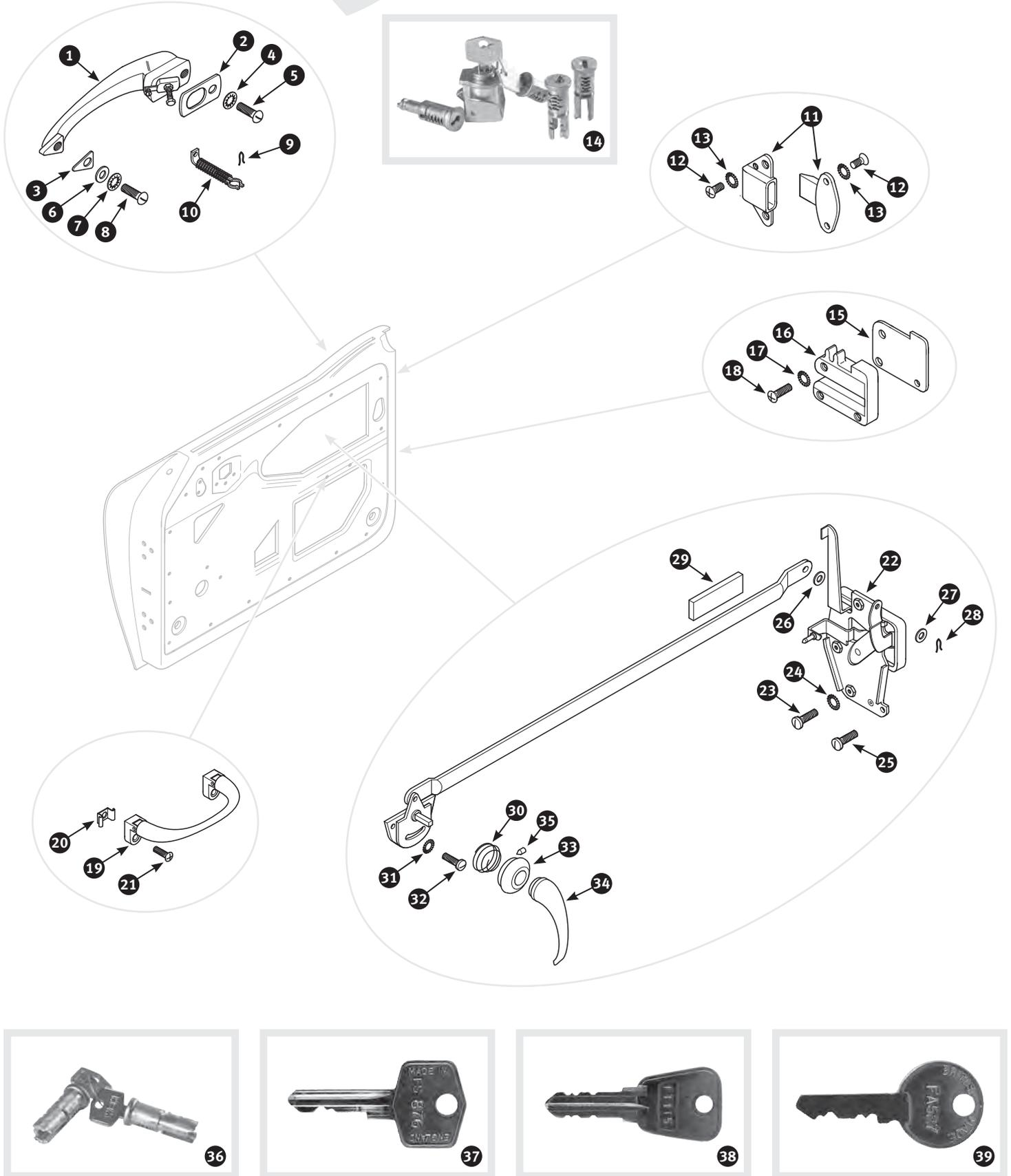

No	Part No	Description	Qty	Notes	
1	15257	Door handle outer, including door lock	1	} Replacement	
2	19448	Gasket door handle - large	2		
3	2041	Gasket door handle - small	2		
4	214403	Shakeproof washer	2		
5	10478	Panhead screw	2		
6	7793	Plain washer	2		
7	214403	Shakeproof washer	2		
8	10478	Panhead screw	2		
9	9631	Retaining clip	2		
10	293500	Connection link door handle to lock	2		
11	200627	Wedge and catch - door restraint device	2		
12	2738	Screw	12		
13	10485	Shakeproof washer dished	12		
14	19374	Private lock set chromed	1		} Contains door lock set, boot handle with barrel, cubby lock and ignition tumbler with matched pair of keys
15	20936	Packing piece lock striker	0	} Quantity as required	
16	200628	Lock striker LH door	1		
16	200629	Lock striker RH door	1		
17	10485	Shakeproof washer dished	6		
18	1134	Countersunk screw lock striker - with locking patch	6		
19	1607	Handle door inner - chromed	2		
20	12910	Captive nut	4		
21	3324	Screw	4		
22	476	Door lock LH door	1		
22	294054	Door lock RH door	1		
23	10478	Panhead screw	6		
24	214403	Shakeproof washer	8		
25	3821	Self tapping screw	2		
26	212191	Plain washer	4		
27	294519	Wavy washer	2		
28	9631	Retaining clip	2		
29	1346	Felt strip	2		
30	1345	Spring door release handle	2		
31	214403	Shakeproof washer	6		
32	10478	Panhead screw	6		
33	448	Escutcheon door release handle	2		
34	308878	Door release handle chromed	2		
35	6333	Pin locating door release handle	2		
36	217420	Private lock set chromed	1	} Contains door lock set with matched pair of keys	
37	6339	Key key code: FS	1		} To identify the correct boot lock key for your vehicle, add the three-digit combination to your key code to, i. e. FS876
38	299474	Key key code: FT	1		
39	329195	Key key code: FA	1		



Luster Lace polish strips are designed to work on all round and tubular metal surfaces. The polish is in the cloth of the strips, no other utilities are needed to get the perfect finish. Luster Lace is fast and easy to use with 360° polishing power that can't be beat. So now you can save up to 70% of your work time. Luster Lace comes in three convenient sizes (narrow, medium, wide) for the care of parts of all sizes.

- Luster Lace Narrow - for wire wheels and filigree parts
- Luster Lace Medium - for headlamp rims, tubular manifolds etc.
- Luster Lace Wide - for large diameters like silencers
- Luster Lace Combo - complete assortment, for all parts

Luster Lace Polishing strips

,combo'. Content: 4 strips 1/2" wide, 3 strips 3/4" wide and 2 strips 1.1/4" wide
 Part no. 485440

18.10

Fittings and external trim parts

Mouldings and wing beadings - TR2, TR3, TR3A and TR3B

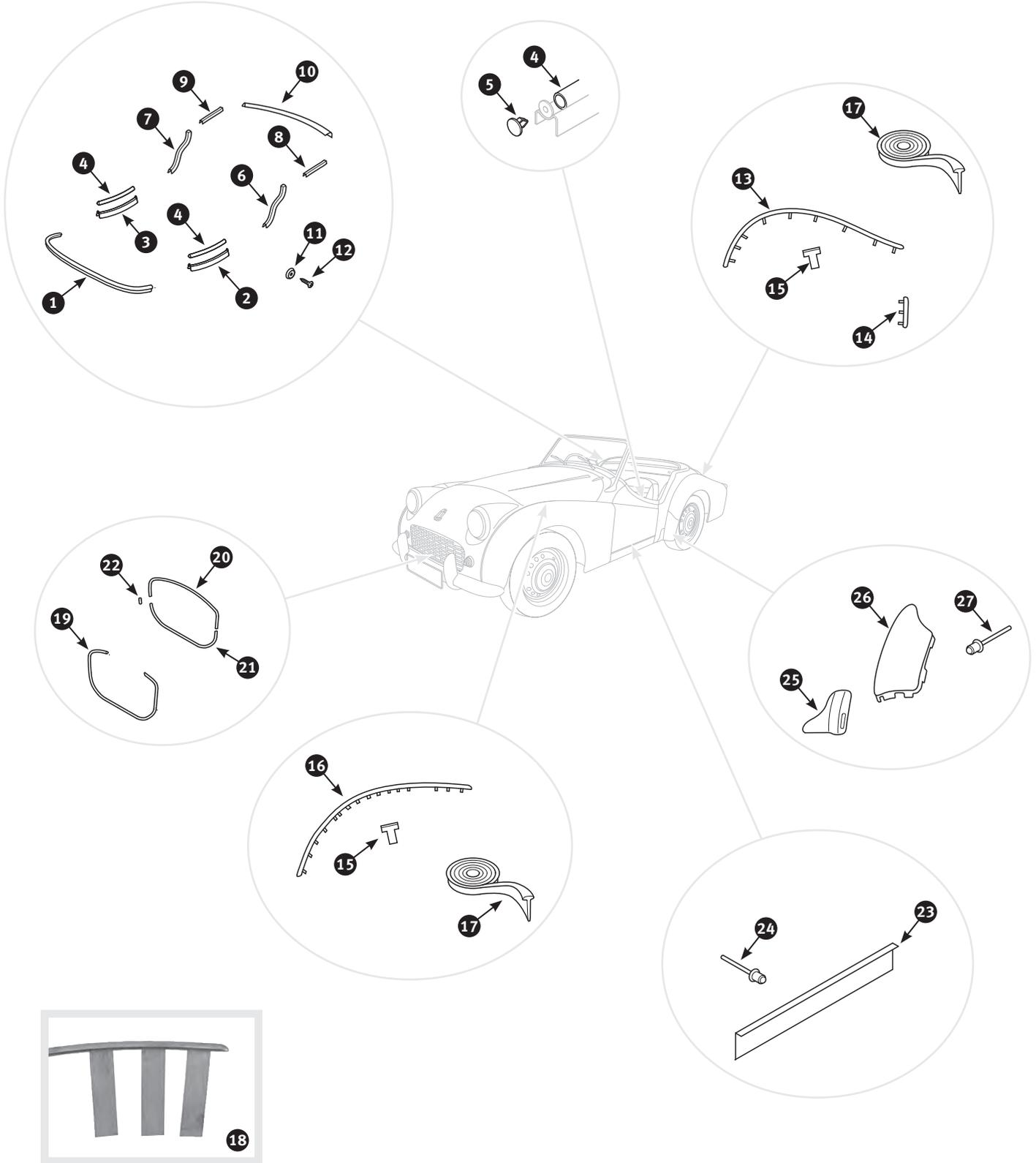

No	Part No	Description	Qty	Notes
1	21441	Capping top of dashboard - fibreglass	1	
2	20406	Capping LH door - metal	1	
2	21437	Capping LH door, fibreglass	1	
3	20407	Capping RH door - metal	1	
3	21438	Capping RH door - fibreglass	1	
4	18925	Rubber core door capping	2	
5	12089	End cap door capping - chromed	4	} TR3A and TR3B
6	203946	Capping behind LH ,B' post - fibreglass	1	
7	21434	Capping behind RH ,B' post - fibreglass	1	
8	22851	Capping LH tonneau area - metal	1	
8	227873	Capping LH tonneau area - fibreglass	1	
9	22850	Capping RH tonneau area - metal	1	
9	300678	Capping RH tonneau area - fibreglass	1	
10	22849	Capping centre tonneau area - steel	1	
11	12587	Cup washer	10	
12	11049	Self tapping screw	10	
13	395	Beading rear wing, long - stainless steel	2	} TR3, TR3A und TR3B - fits also to all TR2
14	396	Beading rear wing, short - stainless steel.	2	
15	2474	Bracket wing beading	50	
16	394	Beading front wing - stainless steel.	2	} TR2
17	300793	Beading wing, plastic - supplied per metre.	10	
18	11578	Beadings for wings - 6 piece stainless steel kit	1	
19	288887	Chrome moulding radiator grille	1	} TR2
20	213947	Chrome moulding radiator grille - upper	1	
21	213948	Chrome moulding radiator grille - lower.	1	} TR3
22	21368	Finishing clip grille mouldings.	1	
23	526	Threshold plate LH inner sill.	1	} Aluminium
23	527	Threshold plate RH inner sill.	1	
23	2560	Threshold plate LH inner sill.	1	} Stainless steel
23	2561	Threshold plate RH inner sill.	1	
24	10085	Pop rivet threshold plate to sill.	4	
25	408	Stoneguard LH rear wing - small	1	
25	409	Stoneguard RH rear wing - small.	1	
26	477	Stoneguard LH rear wing - large	1	
26	478	Stoneguard RH rear wing - large	1	
27	10085	Pop rivet stoneguard to rear wing.	0	} Quantity as required

Autoglym Collection ,immaculate'
 content: 325 ml bodywork shampoo
 conditioner, 325 ml super resin polish,
 325 ml car glass polish, 325 ml vinyl &
 rubber care
 Part no. 245385



18.11

Fittings and external trim parts

Mouldings and wing beadings - TR4 and TR4A

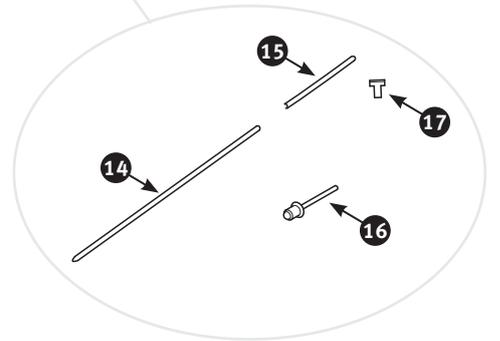
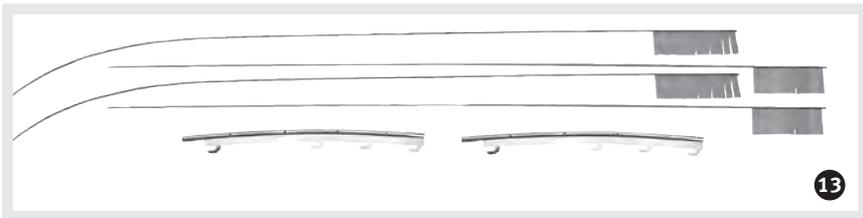
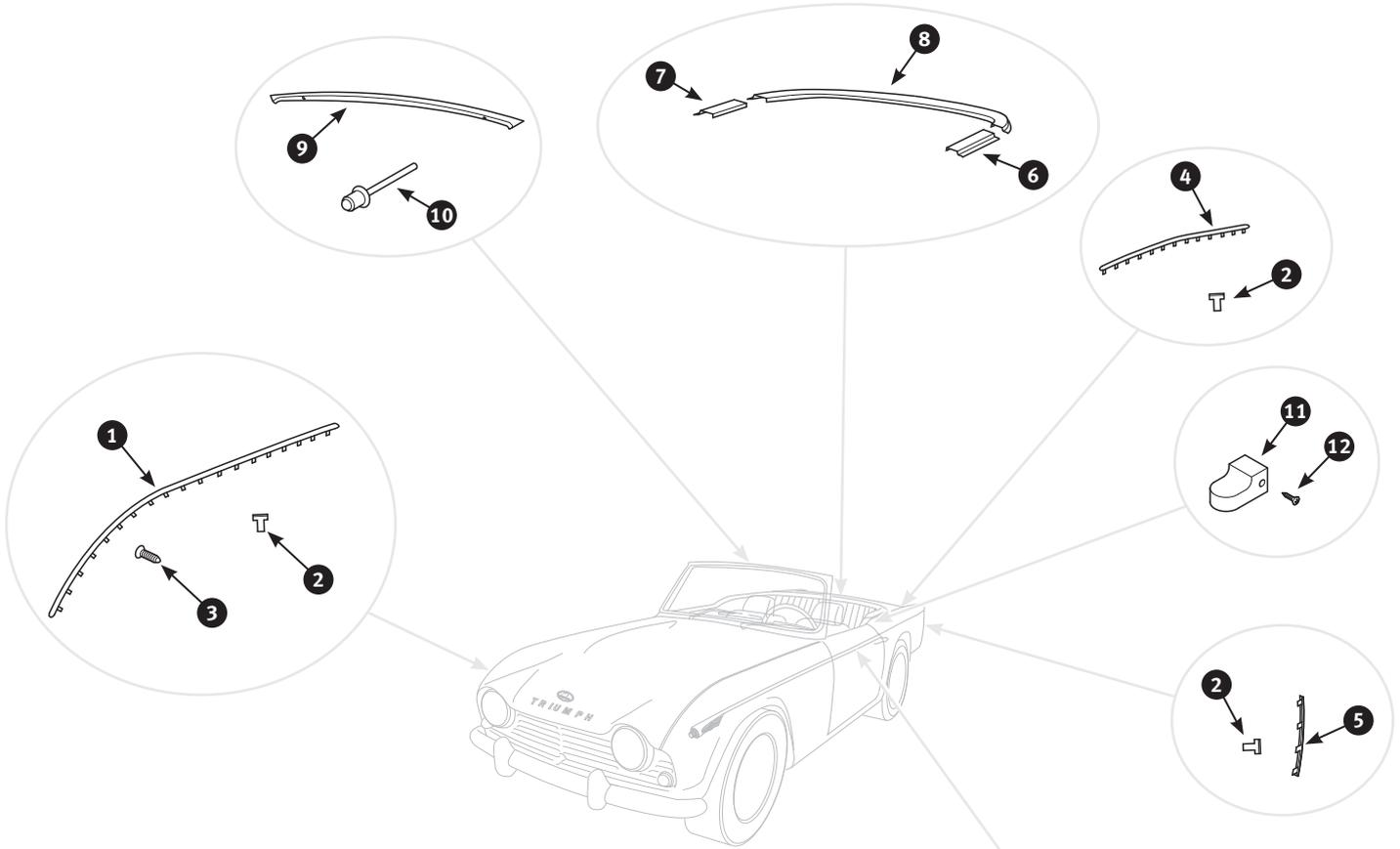

No	Part No	Description	Qty	Notes
1	170	Beading front wing - stainless steel.	2	
2	2474	Bracket wing beading	52	
4	139	Beading rear wing, long - stainless steel	2	
3	3818	Self tapping screw beading to top end of wing	2	
5	141	Beading rear wing, short - stainless steel.	2	
6	300813	Aluminium moulding LH.	1	} TR4 variants with soft top - hood fastener to body
7	300814	Aluminium moulding RH.	1	
8	300798	Aluminium moulding centre	1	
9	20117	Aluminium cover top of windscreen frame	1	} All TR4, TR4A variants with surrey top
9	10504	Aluminium cover top of windscreen frame	1	
10	10085	Pop rivet	11	
11	435	Aluminium cover on LH ,B' post	1	} TR4A
11	436	Aluminium cover on RH ,B' post	1	
12	5027	Self tapping screw	2	
13	11577	Beadings for wings - 6 piece stainless steel kit	1	
14	1241	Moulding front wing - stainless steel.	2	} TR4A
15	1232	Moulding door - stainless steel.	2	
16	202031	Pop rivet moulding on front wing and door	26	
17	1914	Blind fix moulding on door - plastic	2	
18	19566	Threshold plates sill - aluminium. Supplied in pairs	1	
19	3219	Threshold plate sill - stainless steel with ,Triumph laurel wreath' logo.	1	



Wringer
for chamois and towels. Heavy duty steel construction, virtually indestructible. Removes 90% of the water. Cylinder width: 30 cm
Part no. 290337

Chamois
2.5 sqf.
Part no. 292546

4 sqf.
Part no. 292581

19.1

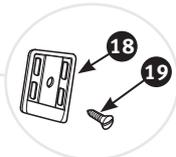
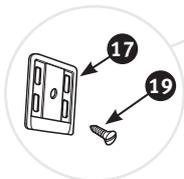
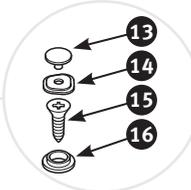
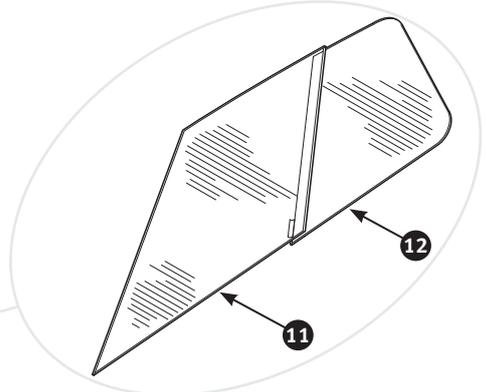
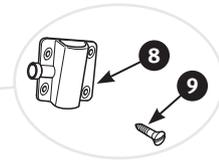
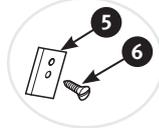
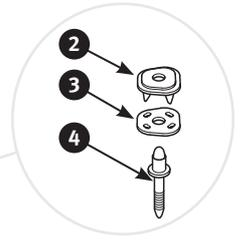
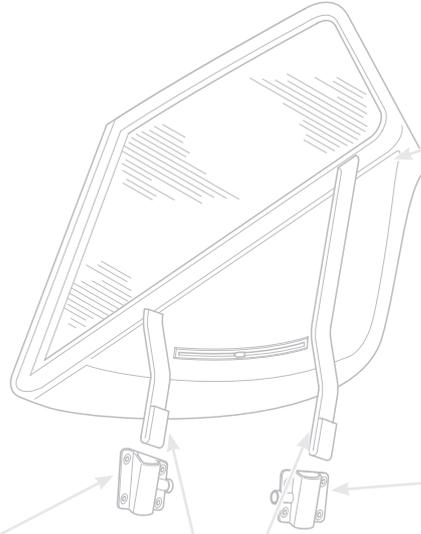

No	Part No	Description	Qty	Notes
1	20665	Side screen LH, in black.	1	TR2 identify by fixed windows
1	20666	Side screen RH, in black.	1	
1	20667	Side screen LH, in white.	1	
1	20668	Side screen RH, in white	1	
1	25360	Side screen LH, in black.	1	TR3, TR3A to TS28825 identify by sliding windows
1	25361	Side screen RH, in black.	1	
1	25362	Side screen LH, in white.	1	
1	25363	Side screen RH, in white	1	
2	389	Lift the dot socket fastener - fixed on side screen.	8	TR2 and TR3, TR3A to TS28825
3	390	Lift the dot clinch plate - fixed on side screen	8	
4	11416	Lift the dot peg - fixed on door.	8	
5	20694	Striker wedge	4	
6	21157	Panhead screw striker wedge retaining	4	
7	25927	Bracket side screen - LH front and RH rear.	2	
8	25926	Bracket side screen - RH front and LH rear.	2	
9	20984	Wood screw bracket to door.	16	
10	533	Side screen LH, in black.	1	
10	534	Side screen RH, in black.	1	
10	535	Side screen LH, in white.	1	TR3A from TS28826, TR3B
10	536	Side screen RH, in white	1	
11	21018	Window in side screen - fixed cobex section	2	
12	15992	Window in LH side screen - sliding section.	1	
12	15993	Window in RH side screen - sliding section	1	
13	4221	Durable dot button fixed on side screen	2	
14	9306	Durable dot socket fixed on side screen	2	
15	18071	Self tapping screw durable dot fastener to door.	2	
16	203055	Durable dot fastener fixed on door	2	
17	4464	Bracket side screen - LH front and RH rear.	2	
18	4465	Bracket side screen - RH front and LH rear.	2	
19	20984	Wood screw bracket to door.	16	
20	399	Dzus fastener side screen to bracket.	4	
21	398	Washer for Dzus fastener	4	
22	10280	Square key to secure side screen	1	

Autoglym Collection - ,valeting'
 content: 325 ml super resin polish, 325 ml
 bodywork shampoo conditioner, 500 ml
 vinyl & rubber care, 500 ml clean wheels,
 a jumbo wash sponge and a perfect
 polishing cloth
 Part no. 366198



19.2

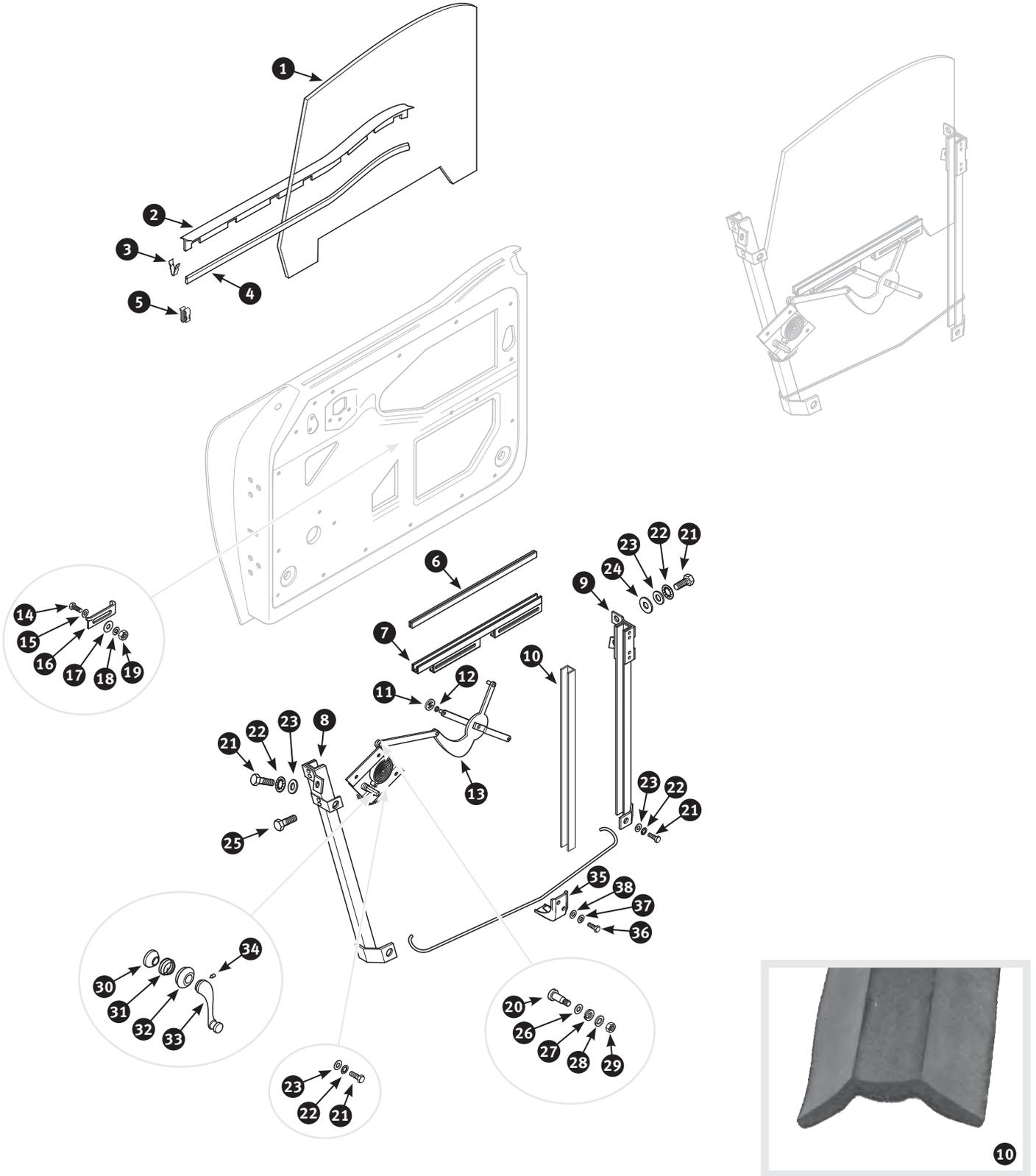

No	Part No	Description	Qty	Notes
1	497	Door glass clear	2	
1	14377	Door glass green tinted	2	
2	26272	Door glass seal LH outer	1	
2	26273	Door glass seal RH outer	1	
3	1891	Retaining clip outer door glass seal.	14	
4	26270	Door glass seal LH inner	1	
4	168	Door glass seal RH inner	1	
5	1932	Retaining clip inner door glass seal.	14	
6	10681	Glazing rubber door glass.	1	
7	26408	Retainer door glass LH door.	1	
7	300804	Retainer door glass RH door.	1	
8	13092	Channel door glass LH door - front	1	
8	13093	Channel door glass RH door - front	1	
9	25149	Channel door glass LH door - rear.	1	
9	25150	Channel door glass RH door - rear	1	
10	12645	Felt strip door glass channel.	4	} Supplied per metre
11	10443	Clip retainer to window regulator	4	
12	9537	Leather washer	8	
13	204164	Window regulator LH door	1	
13	219086	Window regulator RH door	1	
14	3120	Pointed screw	2	
15	212191	Plain washer	2	
16	300754	Stop window regulator.	2	
17	7794	Plain washer	4	
18	212192	Spring washer	2	
19	2828	Nut	2	
20	300792	Pivot bolt window regulator	2	
21	3120	Pointed screw door glass channel to door	17	
22	209089	Shakeproof washer	17	
23	7794	Plain washer - small	17	
24	2831	Plain washer - large.	4	
25	7884	Screw	2	
26	11804	Plain washer	6	
27	6307	Double coil washer	2	
28	212194	Spring washer	2	} TR4 to CT35273
28	11804	Plain washer	2	} TR4 from CT35274, TR4A
29	7739	Nut	2	
30	10447	Foam pad window winder handle	2	
31	1345	Spring between escutchion and window winder handle.	2	
32	448	Escutcheon under window winder handle.	2	
33	425	Window winder handle chromed	2	
34	6333	Pin locating window winder handle.	2	
35	200885	Stop door glass.	2	
36	214337	Panhead screw	4	
37	212190	Spring washer	4	
38	7793	Plain washer	2	

19.3

Glass and glazing Windscreen and interior driving mirror - TR2 to TR3B

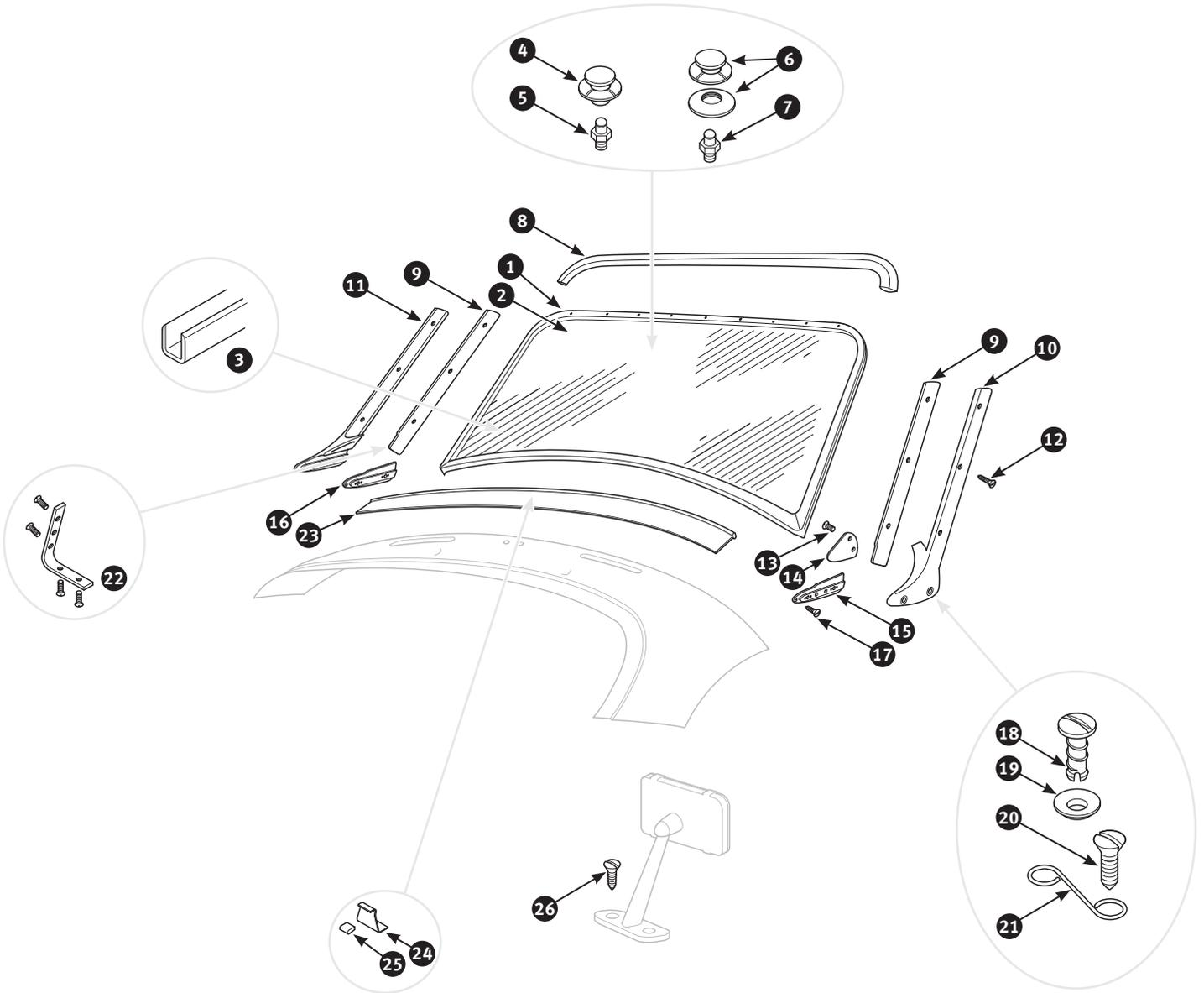

No	Part No	Description	Qty	Notes
1	216294	Windscreen frame	1	
2	2540	Windscreen clear	1	
2	316863	Windscreen green tinted.	2	
3	21073	Glazing rubber windscreen	1	
4	479300	Tenax fastener	10	} TR2 to TS5513. If not available use later fittings (ill. 6 and 7) as a set
5	290287	Tenax peg	10	
6	8015	Tenax fastener with base	10	} TR2 from TS5514, TR3, TR3A and TR3B
7	393	Tenax peg	10	
8	107	Rubber seal between hood and windscreen frame	1	
9	19896	Retainer pillar to windscreen frame	2	
10	3846	Pillar windscreen frame, LH side	1	} TR2 and TR3, TR3A to TS60000
11	201878	Pillar windscreen frame, RH side	1	
10	212723	Pillar windscreen frame, LH side	1	} TR3A from TS60001, TR3B
11	10591	Pillar windscreen frame, RH side	1	
12	1806	Countersunk screw - length: 7/8"	2	} Pillar to windscreen frame
12	391	Countersunk screw - length: 23/32"	4	
13	5692	Self tapping screw corner block to pillar	4	
14	20981	Corner block pillar	1	
15	201688	Guide plate LH pillar	1	} TR2 and TR3, TR3A to TS60000
16	201689	Guide plate RH pillar	1	
17	20959	Countersunk screw guide plate to body	4	} TR3A from TS60001, TR3B
18	397	Dzus fastener pillar to guide plate	4	
19	2475	Washer Dzus fastener	4	
20	14918	Spring Dzus fastener	4	
21	116	Screw pillar to body	4	
22	3122	Fixing bracket with screws - windscreen corner	2	
23	201040	Rubber seal windscreen frame to body	1	
24	2488	Bracket centre windscreen support	1	
25	2489	Rubber in windscreen centre bracket	1	
26	11320	Countersunk screw mirror mounting	2	
27	2486	Interior mirror with stem, black	1	} Identify by bare edges
28	17135	Interior mirror with stem, black	1	
29	204224	Interior mirror with adjustable stem, chromed	1	} May replace original mirror



Brooklands aeroscreen
without brackets
Part no. 450

19.4

Glass and glazing Windscreen and interior driving mirror - TR4 and TR4A

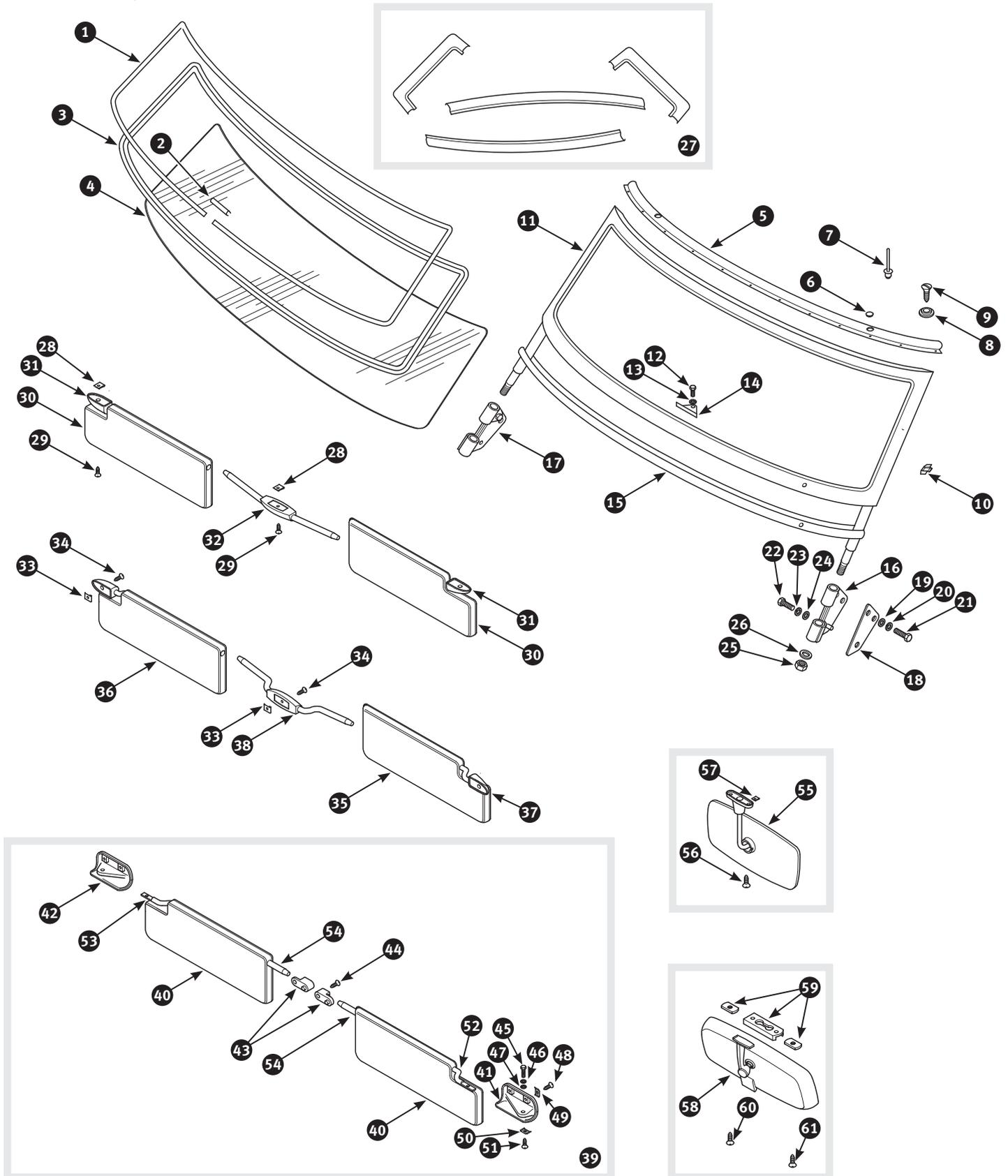

19.4

No	Part No	Description	Qty	Notes
1	121	Filler strip windscreen glazing rubber - chromed plastic.	1	
2	9559	Finishing clip	1	
3	17681	Glazing rubber windscreen	1	
4	971	Windscreen clear	1	
4	316246	Windscreen green tinted.	1	
4	16228	Windscreen green tinted with heavy top in green	1	
4	316247	Windscreen green tinted with heavy top in blue	1	
5	20117	Aluminium cover top of windscreen frame	1	} All TR4, TR4A variants with surrey top } TR4A with soft top
5	10504	Aluminium cover top of windscreen frame	1	
6	16497	Plug for aluminium cover	2	
7	10085	Pop rivet aluminium cover to windscreen frame	11	
8	203055	Durable dot fastener hood to windscreen frame	2	
9	13853	Self tapping screw for durable dot fastener	2	
10	9636	Hook hood to windscreen pillar	2	} TR4
11	300247	Windscreen frame	1	
11	215549	Windscreen frame	1	} TR4A
12	10376	Screw windscreen bracket to centre fascia support	3	
13	10387	Plain washer	3	
14	16513	Support bracket windscreen frame	3	
15	201039	Seal under windscreen frame	1	
16	10305	Bracket windscreen frame to body, LH.	1	
17	299199	Bracket windscreen frame to body, RH.	1	
18	19440	Packing piece windscreen frame bracket	2	
19	12821	Plain washer	4	
20	212192	Spring washer	4	
21	1912	Screw windscreen frame to ,A' post.	4	
22	3072	Screw windscreen frame to ,A' post.	2	
23	212192	Spring washer	2	
24	12821	Plain washer	2	
25	2049	Nyloc nut	2	
26	5337	Plain washer	2	
27	3207	Liner set to cover the inner windscreen frame	1	} Contains 4 liners in black
28	19416	Spire nut	3	
29	310282	Screw	3	
30	18882	Sun visor white	2	} TR4
31	215145	Bracket sun visor outer	2	
32	18032	Bracket sun visor centre.	1	
33	19416	Spire nut	3	
34	310282	Screw	3	
35	215146	Sun visor LH - black.	1	} TR4A
36	215147	Sun visor RH - black	1	
37	297942	Bracket sun visor outer	2	
38	215144	Bracket sun visor centre.	1	
39	338008	Sun visors white, with brackets assembly - LHD	1	} TR6 style - may replace original TR4 and TR4A } sun visors and brackets
39	338340	Sun visors black, with brackets assembly - LHD	1	
39	338341	Sun visors black, with brackets assembly - RHD	1	

19.4

Glass and glazing Windscreen and interior driving mirror - TR4 and TR4A

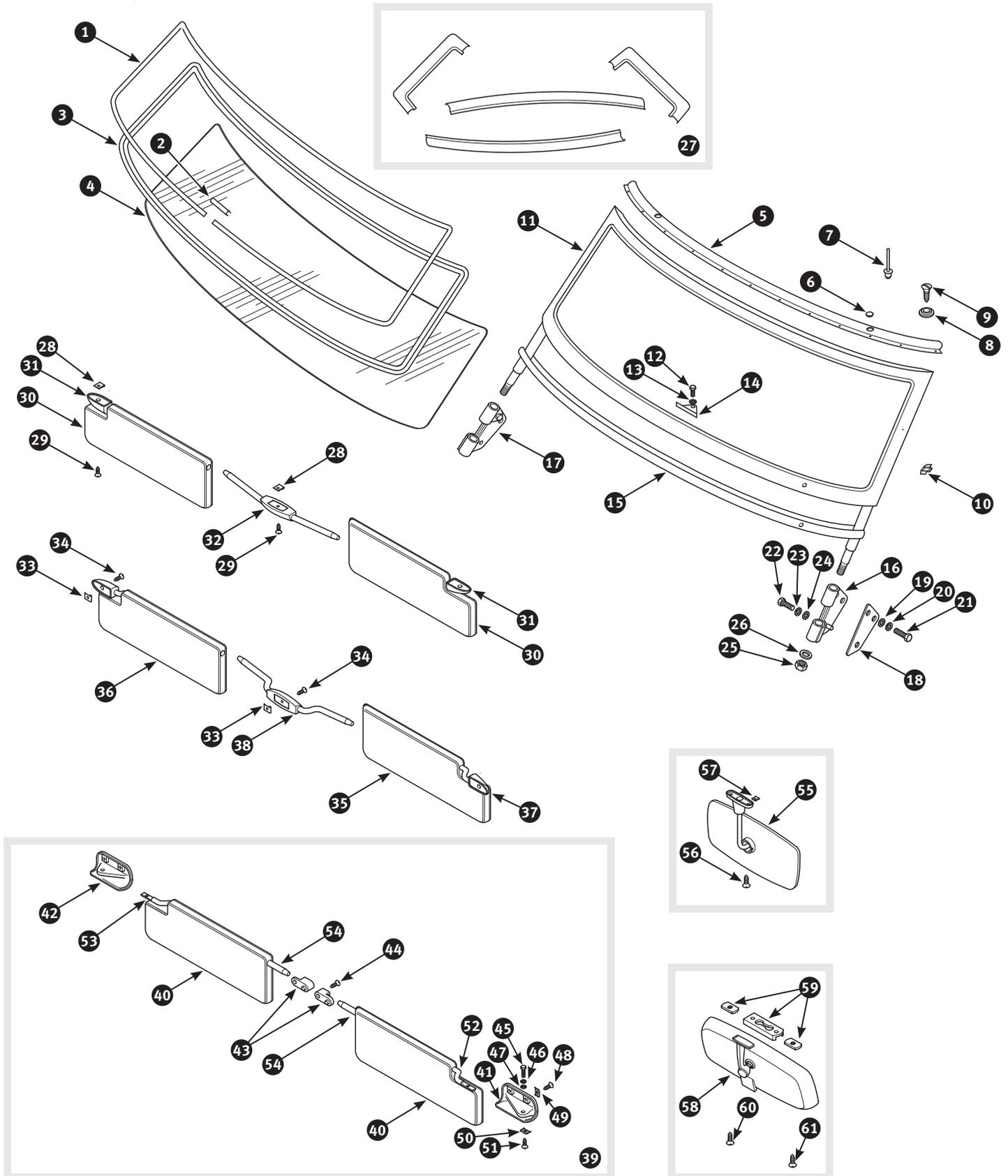

19.4

No	Part No	Description	Qty	Notes	
40	20119	Sun visor white - driver side	1	TR6 style - part of sun visor conversion kits from ill. 39	
40	3841	Sun visor black - driver side	1		
40	20120	Sun visor white, passenger side with mirror - LHD	1		
40	20995	Sun visor white, passenger side with mirror - RHD	1		
40	2554	Sun visor black, passenger side with mirror - LHD	1		
40	16868	Sun visor black, passenger side with mirror - RHD	1		
41	10467	Mounting LH sun visor outer	1		
42	10468	Mounting RH sun visor outer	1		
43	126	Bracket sun visor anchor - rubber	2		
43	317898	Bracket sun visor anchor - polyurethane	2		
44	10741	Screw	2		
45	7884	Screw pivot to outer bracket	2		
46	212191	Plain washer	2		
47	212191	Plain washer	2		
48	4906	Self tapping screw outer bracket to windscreen frame	2		
49	14219	Spire nut	2		
50	9655	Spire nut	4		
51	18510	Self tapping screw	4		
52	2234	Bar LH sun visor	1		
53	1669	Bar RH sun visor	1		
54	1985	Bar sun visor inner	2		
55	11289	Interior mirror with chromed stem and black finish back	1		TR4A style
56	5764	Countersunk screw mirror to windscreen frame	2		
57	19416	Spire nut	2		
58	2095	Interior mirror plastic - assembly	1		TR6 style - may replace original TR4 and TR4A interior mirrors
59	4952	Base plate interior mirror, complete with wedges	1		
60	9619	Screw base plate to windscreen frame	2		
61	17171	Screw stem to mirror head	1		

Screen wash

with citrus fragrance. Keeps the windscreen clean and ice-free and keeps the windscreen washer system from freezing. Performs the best when used pure: up to -70°C.

1 litre
Part no. 394782

5 litres
Part no. 394781



19.5

Glass and glazing Door mirror and wing mirror

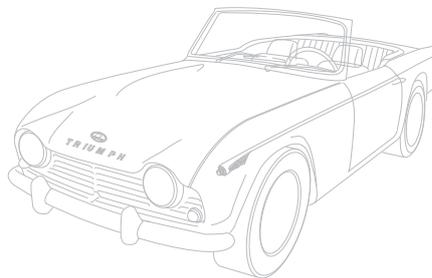
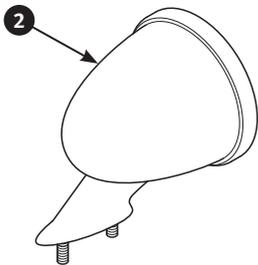
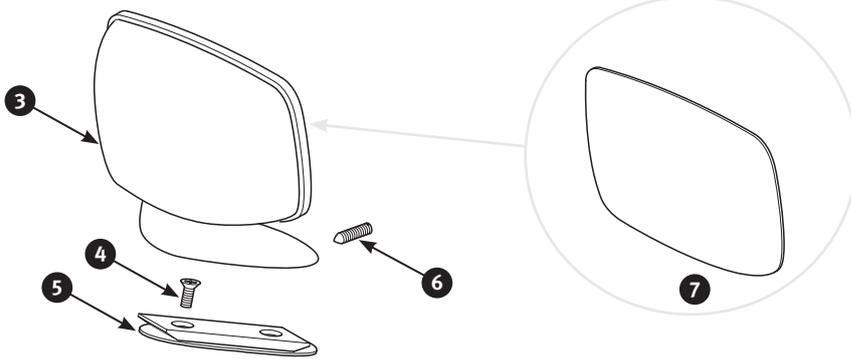
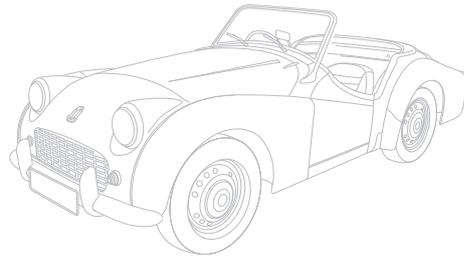
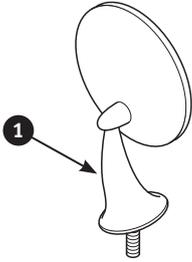

No	Part No	Description	Qty	Notes
1	2719	Mirror with flat glass	1	} Fits LH front wing and RH door. Ask for our special catalogue.
1	12256	Mirror with convex glass.	1	
1	2718	Mirror with flat glass	1	} Fits RH front wing and LH door. Ask for our special catalogue.
1	12255	Mirror with convex glass.	1	
2	7371	Wing mirror chromed with flat glass	2	} Talbot style. Ask for our special catalogue.
2	20745	Wing mirror chromed with convex glass.	2	
2	477975	Wing mirror stainless steel with flat glass	2	} TR4 and TR4A
3	18221	Door mirror chromed with flat glass for LH door.	1	
3	18220	Door mirror chromed with flat glass for RH door.	1	
3	20785	Door mirror chromed with convex glass for LH door	1	
3	20784	Door mirror chromed with convex glass for RH door	1	
4	3817	Self tapping screw mounting pad to door	4	
5	3582	Mirror mounting pad with fitting plate made from black plastic	2	
6	227461	Grub screw mirror mounting pad.	2	
7	19868	Mirror glass flat.	2	
7	305399	Mirror glass flat and tinted.	2	

Autoglym Screen wash

500 ml

Part no. 220603



4 Catalogues, you must have:

- Oils and lubricants
- Tuning and more
- Accessories
- Tools



Order online: www.Limora.com • www.scparts.co.uk

20.1

Seats and interior trim

Seats and seat covers - TR2

Both front seats with fixed backs

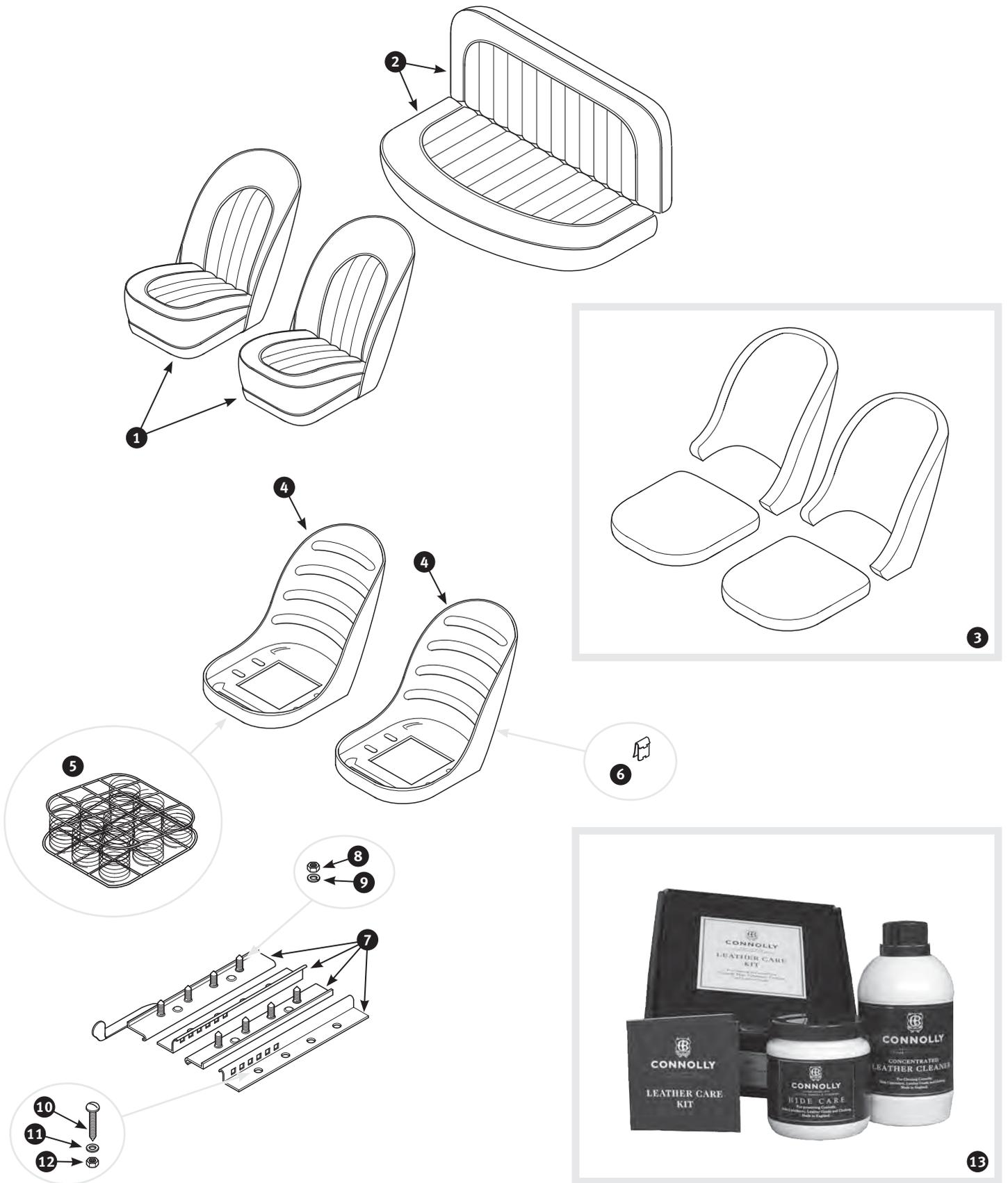

No	Part No	Description	Qty	Notes
1	450815	Vinyl seat covers front seats, black with black piping	1	
1	450817	Vinyl seat covers front seats, cherokee red with cherokee red piping	1	
1	454373	Vinyl seat covers front seats, doeskin with doeskin piping.	1	
1	451272	Vinyl seat covers front seats, tan with tan piping	1	
1	451273	Vinyl seat covers front seats, midnight blue with midnight blue piping	1	
1	451274	Vinyl seat covers front seats, dove grey with dove grey piping	1	
1	348339	Vinyl seat covers front seats, stone beige with stone beige piping	1	
1	451275	Leather seat covers front seat, black with black piping	1	
1	451276	Leather seat covers front seats, cherokee red with cherokee red piping	1	
1	348338	Leather seat covers front seats, doeskin with doeskin piping.	1	
1	451277	Leather seat covers front seats, tan with tan piping	1	
1	451946	Leather seat covers front seats, midnight blue with midnight blue piping	1	
1	451497	Leather seat covers front seats, dove grey with dove grey piping	1	
1	363443	Leather seat covers front seats, stone beige with stone beige piping	1	
2	21459	Vinyl seat covers rear seat, black with black piping	1	
2	21460	Vinyl seat covers rear seat, cherokee red with cherokee red piping	1	
2	366778	Vinyl seat covers rear seat, doeskin with doeskin piping.	1	
2	453723	Vinyl seat covers rear seat, tan with tan piping	1	
2	21461	Vinyl seat covers rear seat, midnight blue with midnight blue piping	1	
2	368528	Vinyl seat covers rear seat, dove grey with dove grey piping	1	
2	368544	Vinyl seat covers rear seat, stone beige with stone beige piping	1	
2	21488	Leather seat covers rear seat, black with black piping	1	
2	21489	Leather seat covers rear seat, cherokee red with cherokee red piping	1	
2	368561	Leather seat covers rear seat, doeskin with doeskin piping.	1	
2	368636	Leather seat covers rear seat, tan with tan piping	1	
2	21490	Leather seat covers rear seat, midnight blue with midnight blue piping	1	
2	368821	Leather seat covers rear seat, dove grey with dove grey piping	1	
2	368840	Leather seat covers rear seat, stone beige with stone beige piping	1	

Note:
Ask for f.o.c. colour samples.
For details please look at the last page of this catalogue.

20.1

Seats and interior trim

Seats and seat covers - TR2

Both front seats with fixed backs

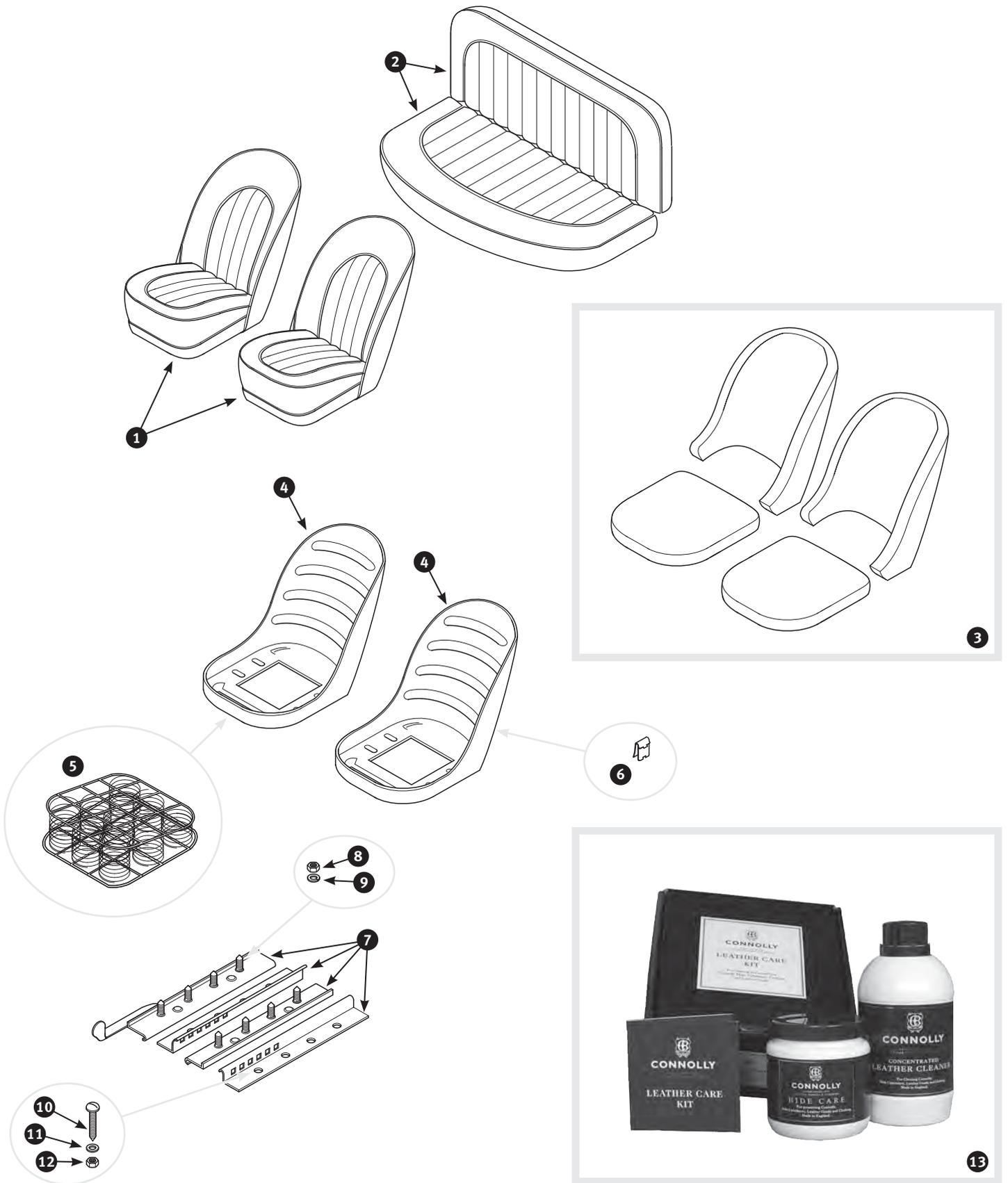

No	Part No	Description	Qty	Notes
2	368842	Rear seat vinyl, black with black piping	1	
2	368858	Rear seat vinyl, cherokee red with cherokee red piping	1	
2	368979	Rear seat vinyl, doeskin with doeskin piping.	1	
2	338680	Rear seat vinyl, tan with tan piping	1	
2	368643	Rear seat vinyl, midnight blue with midnight blue piping	1	
2	368727	Rear seat vinyl, dove grey with dove grey piping	1	
2	368993	Rear seat vinyl, stone beige with stone beige piping	1	
2	369068	Rear seat leather, black with black piping	1	
2	369095	Rear seat leather, cherokee red with cherokee red piping	1	
2	369096	Rear seat leather, doeskin with doeskin piping.	1	
2	369102	Rear seat leather, tan with tan piping	1	
2	369119	Rear seat leather, midnight blue with midnight blue piping	1	
2	369131	Rear seat leather, dove grey with dove grey piping	1	
2	369211	Rear seat leather, stone beige with stone beige piping	1	
3	21453	Seat foam kit front seats	1	} Content: two seat face foams and two seat back foams
4	204252	Seat frame front seat, made from metal.	2	
4	369247	Seat frame front seat, made from fibreglass.	2	} Alternatives
5	12851	Spring core front seat	2	
6	11835	Retaining clip seat cover to seat frame	0	} Quantity as required
7	17828	Seat runners LH front seat	1	
7	17829	Seat runners RH front seat	1	} Supplied in sets of 4
8	2828	Nut	16	
9	212192	Spring washer	16	} Seat runner to seat frame
10	387	Screw	12	
11	212191	Plain washer	12	} Seat runner to floor panel
12	2828	Nut	12	
13	355874	Connolly Leather care kit contents: 500 ml leather cleaner and 284 ml hide care waxy cream	1	} Ask for our special catalogue.

Note:
Ask for f.o.c. colour samples.
For details please look at the last page of this catalogue.

20.2

Driver seat with fixed back and passenger seat with tilt back

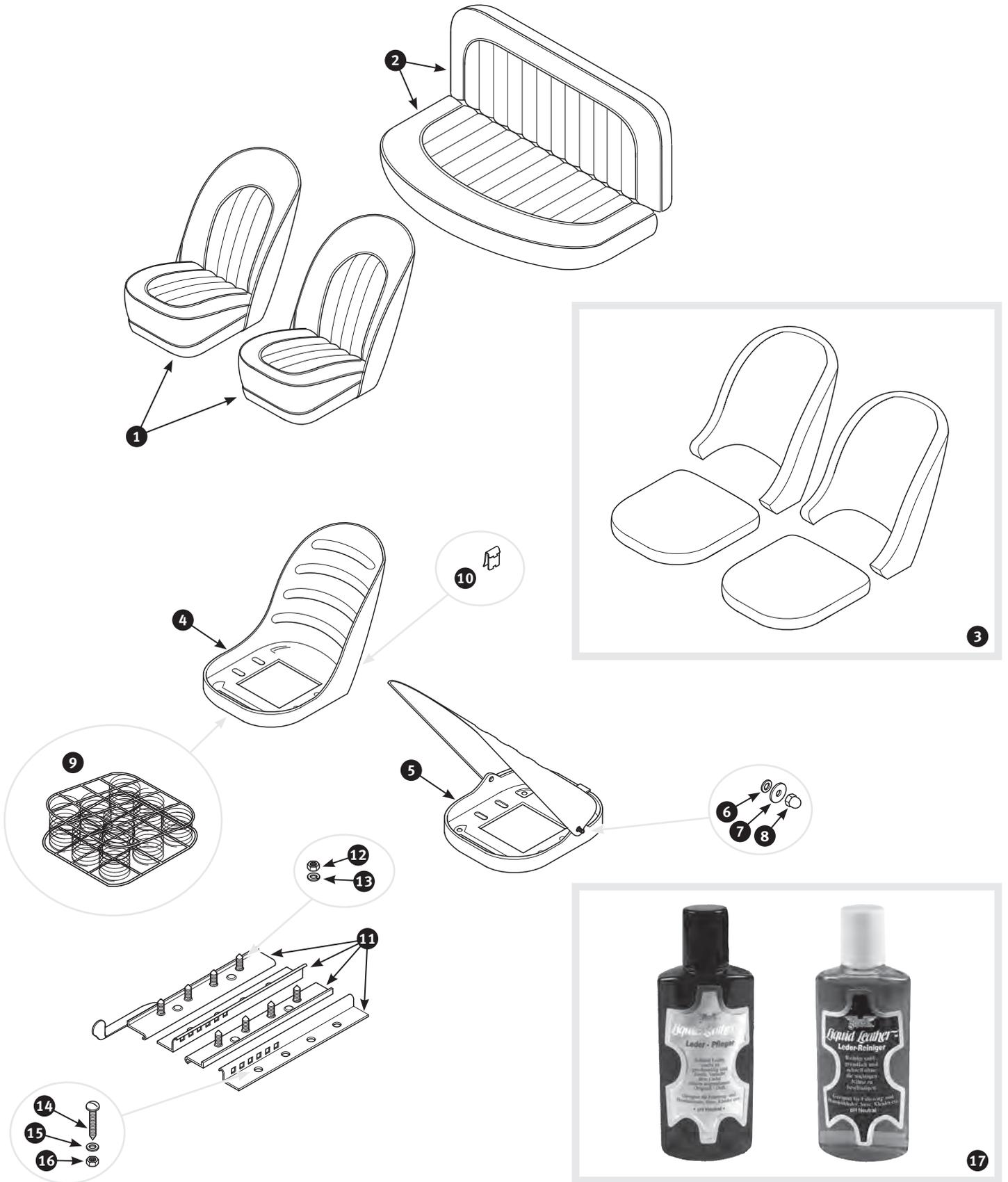

No	Part No	Description	Qty	Notes
1	21533	Vinyl seat covers front seats, black with white piping	1	
1	369462	Vinyl seat covers front seats, cherokee red with white piping	1	
1	21457	Vinyl seat covers front seats, matador red with white piping	1	
1	369259	Vinyl seat covers front seats, doeskin with white piping	1	
1	369389	Vinyl seat covers front seats, tan with white piping.	1	
1	369400	Vinyl seat covers front seats, midnight blue with white piping	1	
1	369425	Vinyl seat covers front seats, dove grey with white piping	1	
1	21482	Leather seat covers front seats, black with white piping	1	
1	369464	Leather seat covers front seats, cherokee red with white piping	1	
1	21483	Leather seat covers front seats, matador red with white piping	1	
1	369260	Leather seat covers front seats, doeskin with white piping	1	
1	369361	Leather seat covers front seats, tan with white piping.	1	
1	369423	Leather seat covers front seats, midnight blue with white piping	1	
1	369449	Leather seat covers front seats, dove grey with white piping	1	
2	21462	Vinyl seat covers rear seat, black with white piping	1	
2	369495	Vinyl seat covers rear seat, cherokee red with white piping	1	
2	369554	Vinyl seat covers rear seat, matador red with white piping	1	
2	369587	Vinyl seat covers rear seat, doeskin with white piping	1	
2	369568	Vinyl seat covers rear seat, tan with white piping.	1	
2	369746	Vinyl seat covers rear seat, midnight blue with white piping	1	
2	369747	Vinyl seat covers rear seat, dove grey with white piping	1	
2	21494	Leather seat covers rear seat, black with white piping	1	
2	21492	Leather seat covers rear seat, cherokee red with white piping	1	
2	21491	Leather seat covers rear seat, matador red with white piping	1	
2	369760	Leather seat covers rear seat, doeskin with white piping	1	
2	369756	Leather seat covers rear seat, tan with white piping.	1	
2	21493	Leather seat covers rear seat, midnight blue with white piping	1	
2	369768	Leather seat covers rear seat, dove grey with white piping	1	

Note:
 Ask for f.o.c. colour samples.
 For details please look at the last page of this catalogue.

20.2

Driver seat with fixed back and passenger seat with tilt back

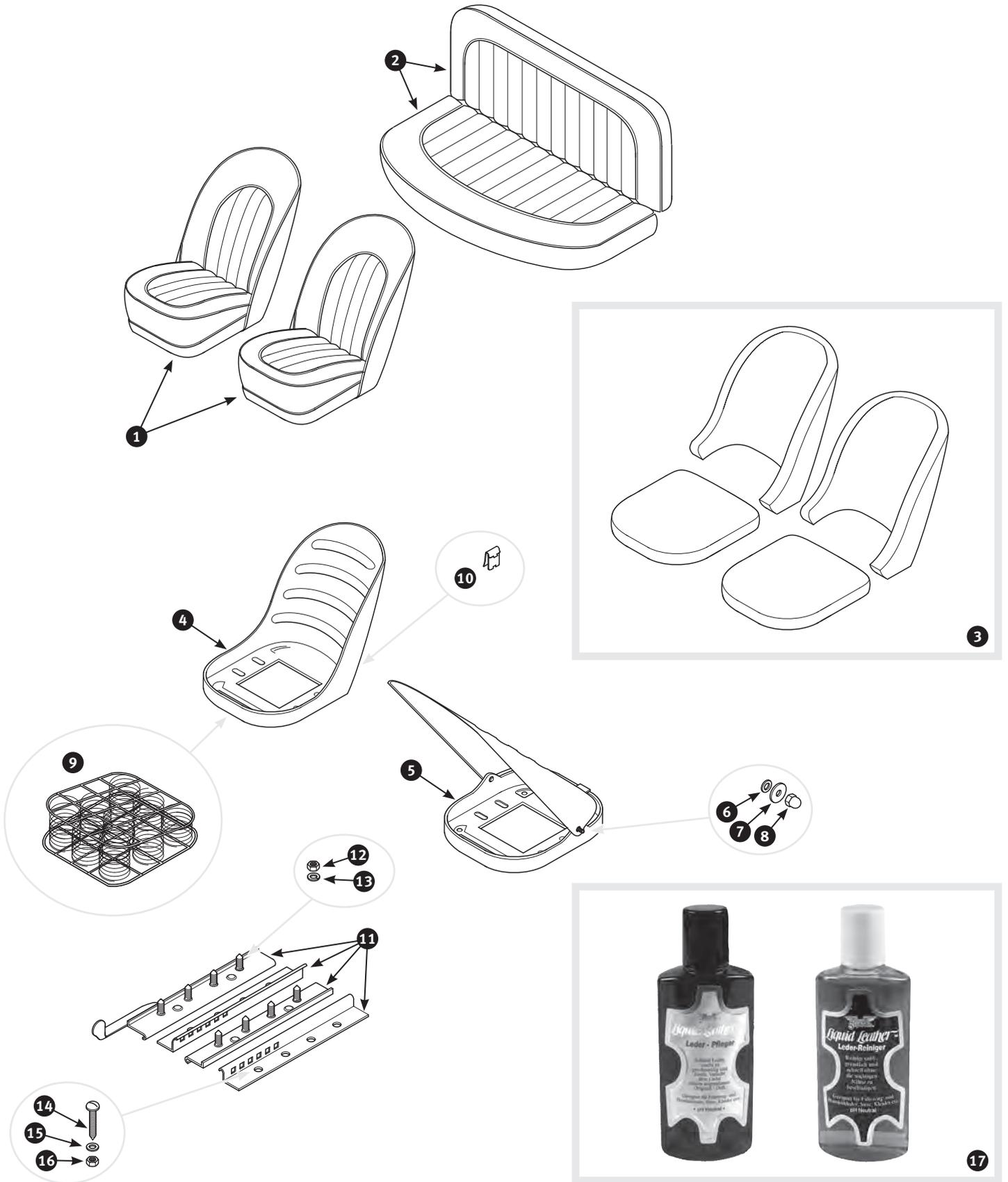

No	Part No	Description	Qty	Notes
2	369769	Rear seat vinyl, black with white piping	1	
2	369798	Rear seat vinyl, cherokee red with white piping	1	
2	369800	Rear seat vinyl, matador red with white piping	1	
2	369809	Rear seat vinyl, doeskin with white piping	1	
2	369806	Rear seat vinyl, tan with white piping	1	
2	369810	Rear seat vinyl, midnight blue with white piping	1	
2	371300	Rear seat vinyl, dove grey with white piping	1	
2	370240	Rear seat leather, black with white piping	1	
2	370242	Rear seat leather, cherokee red with white piping	1	
2	370245	Rear seat leather, matador red with white piping	1	
2	370316	Rear seat leather, doeskin with white piping	1	
2	370309	Rear seat leather, tan with white piping	1	
2	370359	Rear seat leather, midnight blue with white piping	1	
2	370472	Rear seat leather, dove grey with white piping	1	
3	21453	Seat foam kit front seats	1	} Content: two seat face foams and two seat back foams
4	204252	Seat frame driver side. Identify by fixed back	1	
5	204253	Seat frame passenger side. Identify by tilt back	1	
6	3241	Plain washer	2	} Passenger seat only
7	10387	Plain washer chromed	2	
8	8493	Dome nut chromed - seat back to frame	2	
9	12851	Spring core front seat	2	
10	11835	Retaining clip seat cover to seat frame	0	} Quantity as required
11	17828	Seat runners LH front seat	1	} Supplied in sets of 4
11	17829	Seat runners RH front seat	1	
12	2828	Nut	16	} Seat runner to seat frame
13	212192	Spring washer	16	
14	387	Screw	12	} Seat runner to floor panel
15	212191	Plain washer	12	
16	2828	Nut	12	
17	310221	Gliptone Liquid Leather Cleaner 250 ml bottle	1	} Ask for our special catalogue.
17	310220	Gliptone Leather Care 250 ml bottle	1	



Swissvax Leather care kit

All you need to keep your leather in perfect condition. Great attention was put on optics neutral and odourless products, so that leather does not look or smell artificial. Suitable for all leather kinds except aniline leather, water buffalo and suedes.

Content: 250 ml leather cleaner, 250 ml leather milk, 25 ml elephant dubbin, leather brush, care towel and applicator
 Part no. 329976

Note:
 Ask for f.o.c. colour samples.
 For details please look at the last page of this catalogue.

20.3

Driver seat with fixed back and passenger seat with tilt back

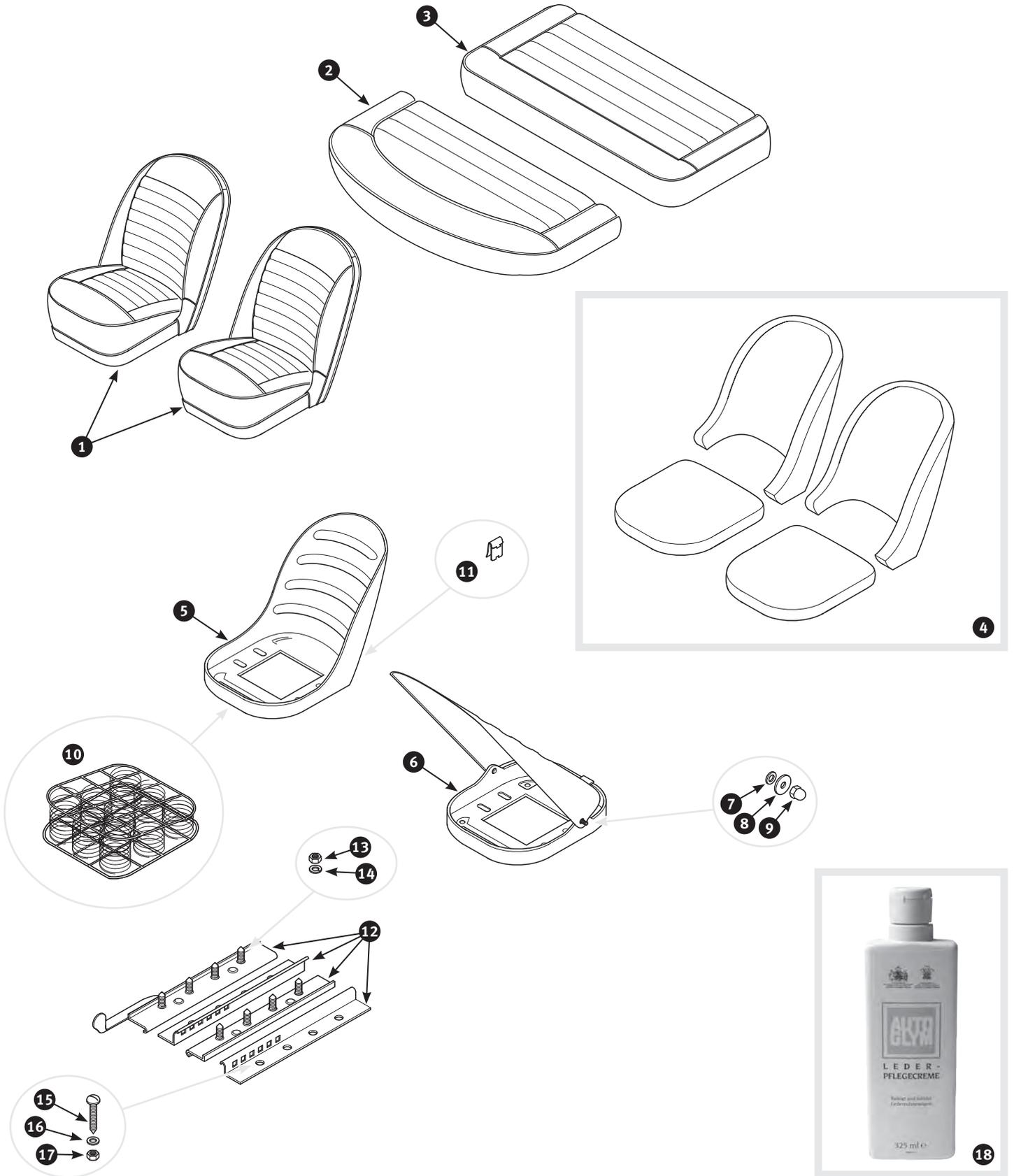

No	Part No	Description	Qty	Notes
1	21536	Vinyl seat covers front seats, black with white piping	1	
1	21534	Vinyl seat covers front seats, cherokee red with white piping	1	
1	370670	Vinyl seat covers front seats, matador red with white piping	1	
1	370929	Vinyl seat covers front seats, doeskin with white piping	1	
1	370930	Vinyl seat covers front seats, beige with white piping	1	
1	370871	Vinyl seat covers front seats, tan with white piping.	1	
1	371078	Vinyl seat covers front seats, midnight blue with white piping	1	
1	371148	Vinyl seat covers front seats, dove grey with white piping	1	
1	371163	Leather seat covers front seats, black with black piping	1	
1	21485	Leather seat covers front seats, black with white piping	1	
1	371203	Leather seat covers front seats, black with red piping.	1	
1	21486	Leather seat covers front seats, cherokee red with white piping	1	
1	371215	Leather seat covers front seats, matador red with white piping	1	
1	371204	Leather seat covers front seats, doeskin with white piping	1	
1	371205	Leather seat covers front seats, beige with white piping	1	
1	371210	Leather seat covers front seats, tan with white piping.	1	
1	371212	Leather seat covers front seats, light tan with light tan piping	1	
1	371216	Leather seat covers front seats, midnight blue with white piping	1	
1	371217	Leather seat covers front seats, dove grey with white piping	1	

Note:
 Ask for f.o.c. colour samples.
 For details please look at the last page of this catalogue.

20.3

Driver seat with fixed back and passenger seat with tilt back

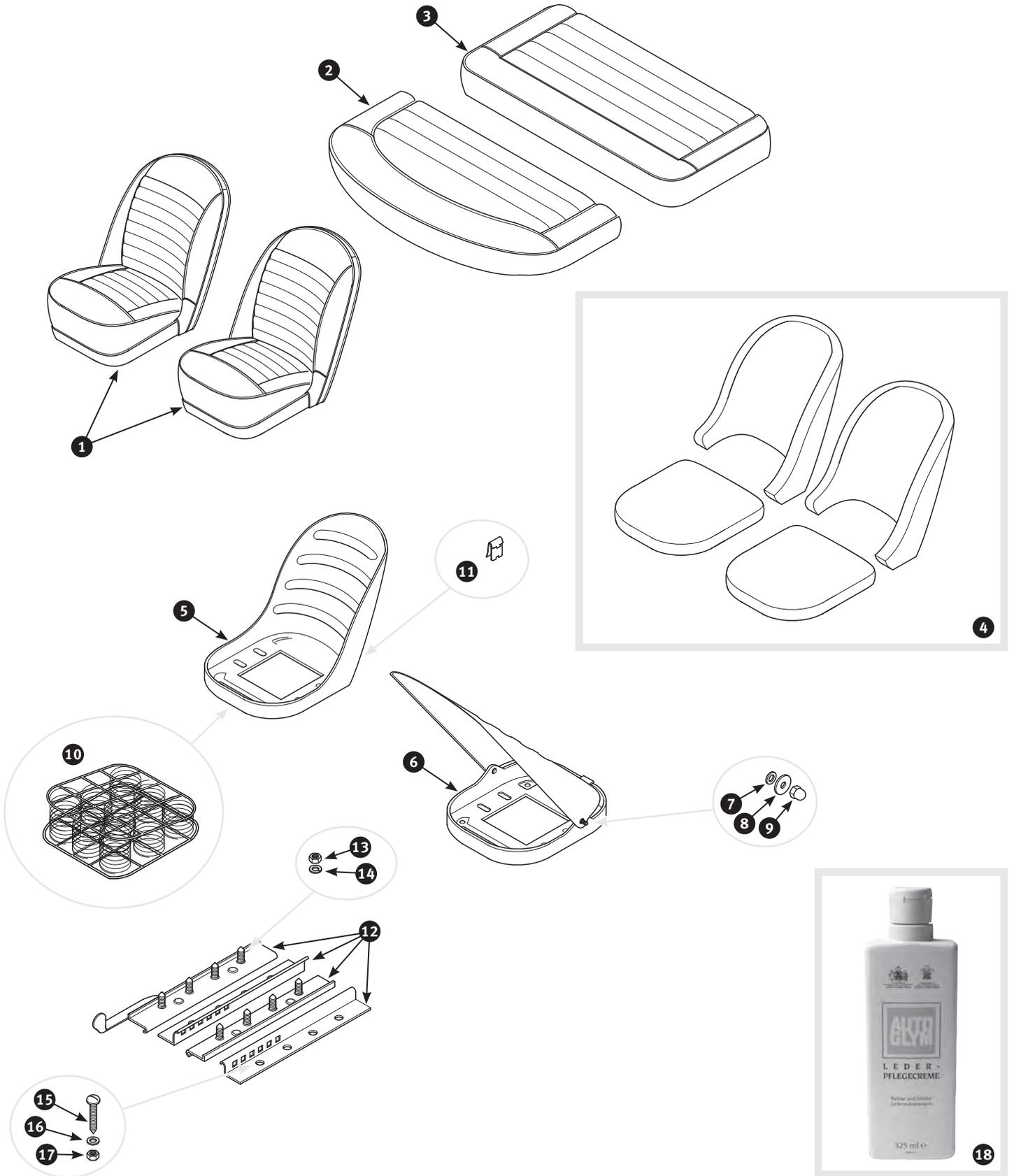

No	Part No	Description	Qty	Notes
2	21465	Vinyl seat covers rear seat, black with white piping	1	TR3A to TS60000
2	21466	Vinyl seat covers rear seat, cherokee red with white piping	1	
2	369989	Vinyl seat covers rear seat, matador red with white piping	1	
2	369821	Vinyl seat covers rear seat, doeskin with white piping	1	
2	369630	Vinyl seat covers rear seat, beige with white piping	1	
2	369957	Vinyl seat covers rear seat, tan with white piping.	1	
2	370002	Vinyl seat covers rear seat, midnight blue with white piping	1	
2	370072	Vinyl seat covers rear seat, dove grey with white piping	1	
2	370171	Leather seat covers rear seat, black with black piping	1	
2	370210	Leather seat covers rear seat, black with white piping	1	
2	371214	Leather seat covers rear seat, black with red piping.	1	
2	21495	Leather seat covers rear seat, cherokee red with white piping	1	
2	371502	Leather seat covers rear seat, matador red with white piping	1	
2	371503	Leather seat covers rear seat, doeskin with white piping	1	
2	371511	Leather seat covers rear seat, beige with white piping	1	
2	371706	Leather seat covers rear seat, tan with white piping.	1	
2	21463	Leather seat covers rear seat, light tan with light tan piping	1	
2	21464	Leather seat covers rear seat, midnight blue with white piping	1	
2	21480	Leather seat covers rear seat, dove grey with white piping	1	
2	372010	Rear seat vinyl, black with white piping.	1	
2	372012	Rear seat vinyl, cherokee red with white piping	1	
2	372014	Rear seat vinyl, matador red with white piping.	1	
2	372080	Rear seat vinyl, doeskin with white piping.	1	
2	372389	Rear seat vinyl, beige with white piping.	1	
2	372391	Rear seat vinyl, tan with white piping	1	
2	372509	Rear seat vinyl, midnight blue with white piping.	1	
2	372621	Rear seat vinyl, dove grey with white piping	1	
2	372736	Rear seat leather, black with black piping	1	
2	372760	Rear seat leather, black with white piping	1	
2	372860	Rear seat leather, black with red piping.	1	
2	273258	Rear seat leather, cherokee red with white piping.	1	
2	273277	Rear seat leather, matador red with white piping	1	
2	273278	Rear seat leather, doeskin with white piping	1	
2	373367	Rear seat leather, beige with white piping	1	
2	373389	Rear seat leather, tan with white piping.	1	
2	373407	Rear seat leather, light tan with light tan piping.	1	
2	373541	Rear seat leather, midnight blue with white piping	1	
2	305648	Rear seat leather, dove grey with white piping	1	

Note:
 Ask for f.o.c. colour samples.
 For details please look at the last page of this catalogue.

20.3

Seats and interior trim

Seats and seat covers - TR3A and TR3B

Driver seat with fixed back and passenger seat with tilt back

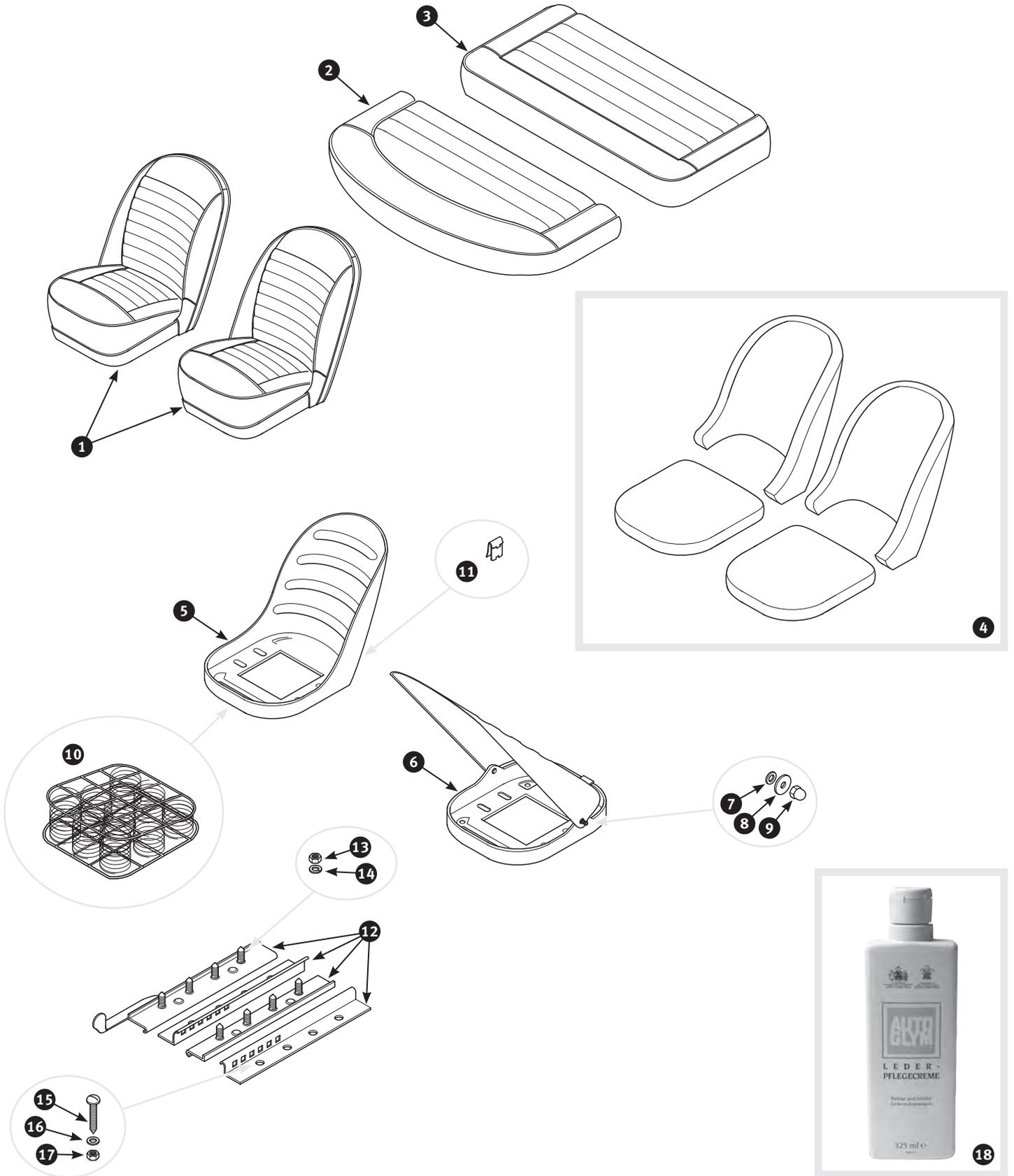

No	Part No	Description	Qty	Notes
3	203892	Vinyl seat covers rear seat, black with white piping	1	TR3A from TS60001, TR3B
3	212414	Vinyl seat covers rear seat, cherokee red with white piping	1	
3	330741	Vinyl seat covers rear seat, matador red with white piping	1	
3	479710	Vinyl seat covers rear seat, doeskin with white piping	1	
3	374001	Vinyl seat covers rear seat, beige with white piping	1	
3	374036	Vinyl seat covers rear seat, tan with white piping.	1	
3	374040	Vinyl seat covers rear seat, midnight blue with white piping	1	
3	374057	Vinyl seat covers rear seat, dove grey with white piping	1	
3	374058	Leather seat covers rear seat, black with black piping	1	
3	21497	Leather seat covers rear seat, black with white piping	1	
3	374112	Leather seat covers rear seat, black with red piping.	1	
3	374222	Leather seat covers rear seat, cherokee red with white piping	1	
3	374712	Leather seat covers rear seat, matador red with white piping	1	
3	374732	Leather seat covers rear seat, doeskin with white piping	1	
3	374744	Leather seat covers rear seat, beige with white piping	1	
3	374751	Leather seat covers rear seat, tan with white piping.	1	
3	374753	Leather seat covers rear seat, light tan with light tan piping	1	
3	347780	Leather seat covers rear seat, midnight blue with white piping	1	
3	374781	Leather seat covers rear seat, dove grey with white piping	1	
3	374800	Rear seat vinyl, black with white piping.	1	
3	375304	Rear seat vinyl, cherokee red with white piping	1	
3	374060	Rear seat vinyl, matador red with white piping.	1	
3	374823	Rear seat vinyl, doeskin with white piping.	1	
3	374827	Rear seat vinyl, beige with white piping.	1	
3	374829	Rear seat vinyl, tan with white piping	1	
3	374988	Rear seat vinyl, midnight blue with white piping.	1	
3	375460	Rear seat vinyl, dove grey with white piping	1	
3	330573	Rear seat leather, black with black piping	1	
3	375305	Rear seat leather, black with white piping	1	
3	375378	Rear seat leather, black with red piping.	1	
3	375456	Rear seat leather, cherokee red with white piping.	1	
3	375457	Rear seat leather, matador red with white piping	1	
3	375458	Rear seat leather, doeskin with white piping	1	
3	375459	Rear seat leather, beige with white piping	1	
3	375377	Rear seat leather, tan with white piping.	1	
3	373820	Rear seat leather, light tan with light tan piping.	1	
3	373823	Rear seat leather, midnight blue with white piping	1	
3	373843	Rear seat leather, dove grey with white piping	1	

Note:
 Ask for f.o.c. colour samples.
 For details please look at the last page of this catalogue.

20.3

Seats and interior trim

Seats and seat covers - TR3A and TR3B

Driver seat with fixed back and passenger seat with tilt back

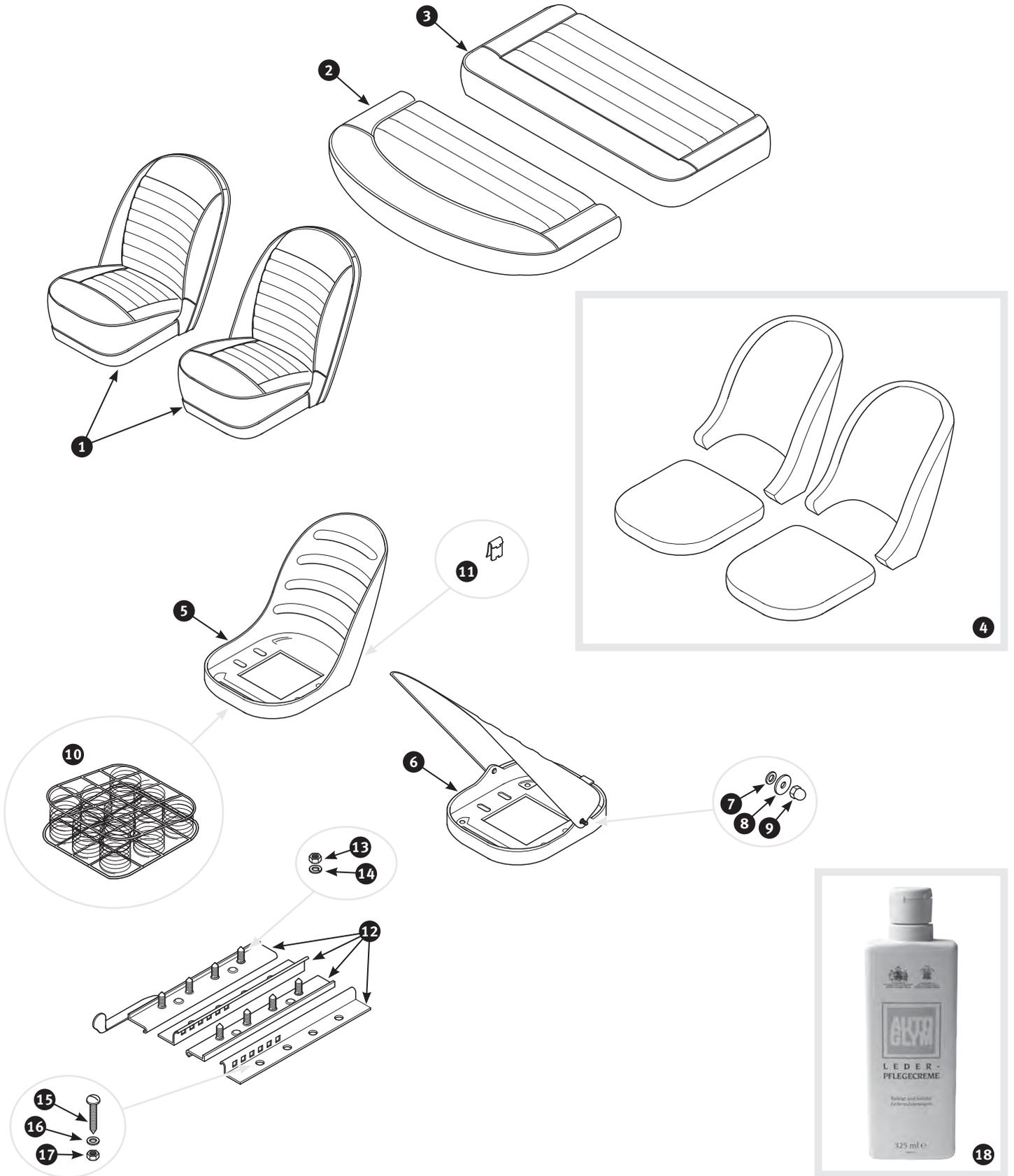

No	Part No	Description	Qty	Notes
4	21453	Seat foam kit front seats	1	} Content: two seat face foams and two seat back foams
5	204252	Seat frame driver side. Identify by fixed back	1	
6	204253	Seat frame passenger side. Identify by tilt back	1	} Passenger seat only
7	3241	Plain washer	2	
8	10387	Plain washer chromed	2	
9	8493	Dome nut chromed - seat back to frame	2	
10	12851	Spring core front seat	2	} Quantity as required
11	11835	Retaining clip seat cover to seat frame	0	
12	17828	Seat runners LH front seat	1	} Supplied in sets of 4
12	17829	Seat runners RH front seat	1	
13	2828	Nut	16	} Seat runner to seat frame
14	212192	Spring washer	16	
15	387	Screw	12	} Seat runner to floor panel
16	212191	Plain washer	12	
17	2828	Nut	12	
18	310443	Autoglym Leather Care 325 ml bottle.	1	} Ask for our special catalogue.

Connolly Leather care kit
 contents: 500 ml leather cleaner
 and 284 ml hide care waxy cream
 Part no. 355874



Note:
 Ask for f.o.c. colour samples.
 For details please look at the last page of this catalogue.

20.4

Seats and interior trim

Seats and seat covers - TR4 to middle of 1963

To chassis no. CT20876

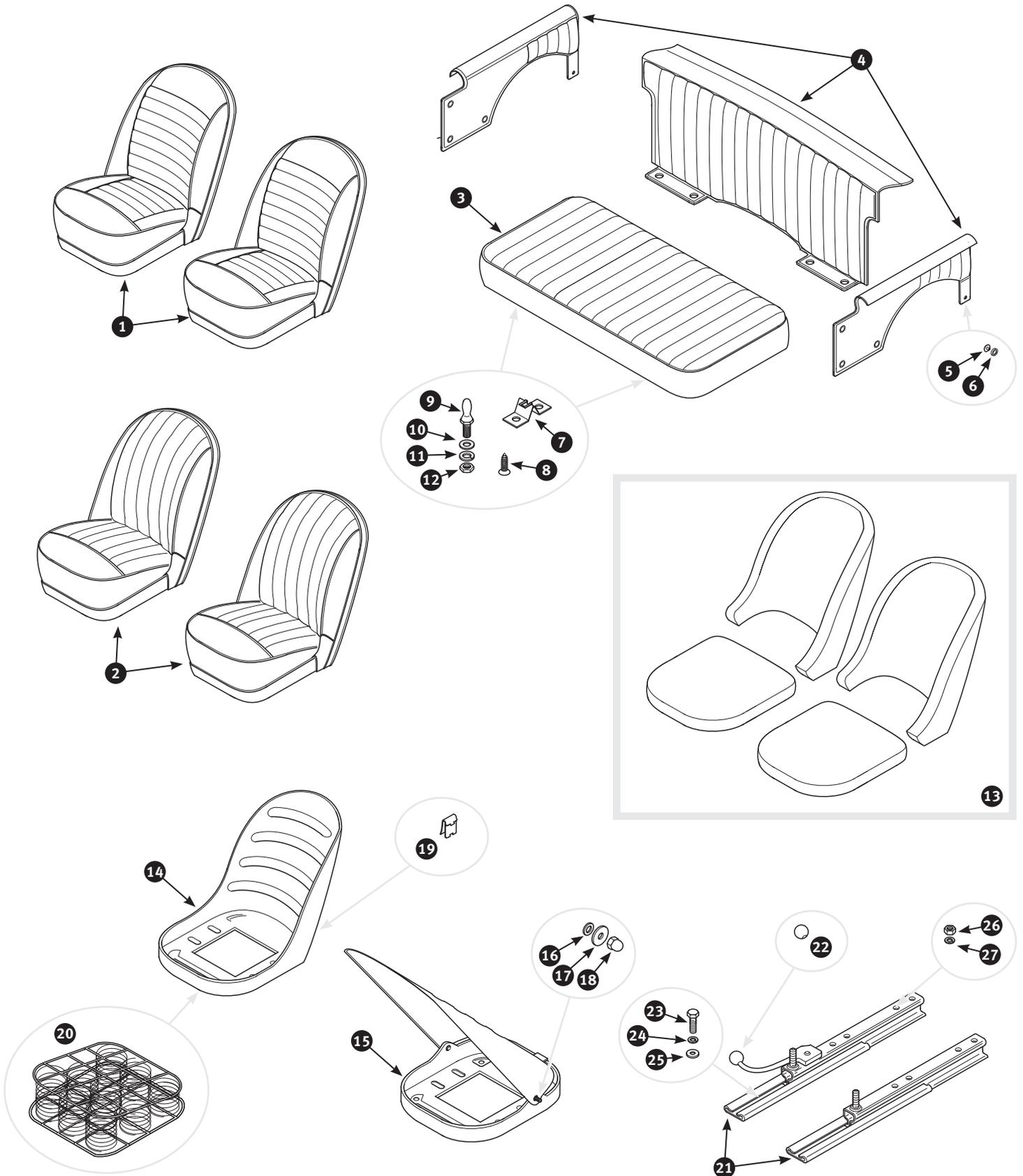

No	Part No	Description	Qty	Notes
1	21536	Vinyl seat covers front seats, black with white piping	1	To CT15273
1	21534	Vinyl seat covers front seats, cherokee red with white piping	1	
1	370670	Vinyl seat covers front seats, matador red with white piping	1	
1	370929	Vinyl seat covers front seats, doeskin with white piping	1	
1	370930	Vinyl seat covers front seats, beige with white piping	1	
1	370871	Vinyl seat covers front seats, tan with white piping.	1	
1	371078	Vinyl seat covers front seats, midnight blue with white piping	1	
1	371148	Vinyl seat covers front seats, dove grey with white piping	1	
1	371163	Leather seat covers front seats, black with black piping	1	
1	21485	Leather seat covers front seats, black with white piping	1	
1	371203	Leather seat covers front seats, black with red piping.	1	
1	21486	Leather seat covers front seats, cherokee red with white piping	1	
1	371215	Leather seat covers front seats, matador red with white piping	1	
1	371204	Leather seat covers front seats, doeskin with white piping	1	
1	371205	Leather seat covers front seats, beige with white piping	1	
1	371210	Leather seat covers front seats, tan with white piping.	1	
1	371212	Leather seat covers front seats, ight tan with light tan piping	1	
1	371216	Leather seat covers front seats, midnight blue with white piping	1	
1	371217	Leather seat covers front seats, dove grey with white piping	1	
2	21537	Vinyl seat covers front seats, black with white piping	1	
2	21538	Vinyl seat covers front seats, cherokee red with white piping	1	
2	21539	Vinyl seat covers front seats, midnight blue with white piping	1	
2	21500	Leather seat covers front seats, black with white piping	1	
2	21501	Leather seat covers front seats, cherokee red with white piping	1	
2	21502	Leather seat covers front seats, midnight blue with white piping	1	

Note:
 Ask for f.o.c. colour samples.
 For details please look at the last page of this catalogue.

20.4

Seats and interior trim

Seats and seat covers - TR4 to middle of 1963

To chassis no. CT20876

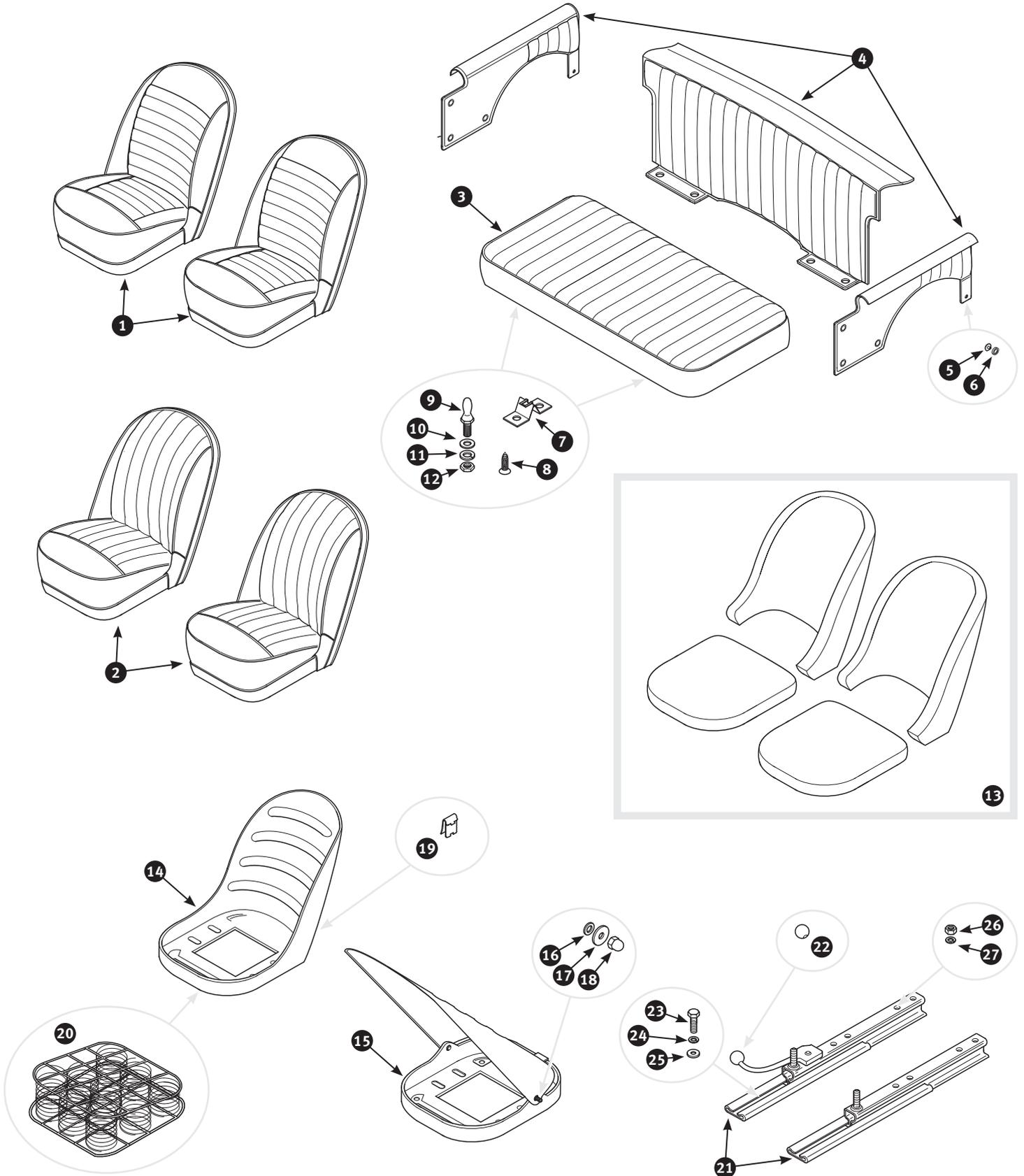

No	Part No	Description	Qty	Notes
3	423352	Vinyl seat covers rear seat, black with white piping	1	
3	423354	Vinyl seat covers rear seat, cherokee red with white piping	1	
3	423401	Vinyl seat covers rear seat, matador red with white piping	1	
3	423404	Vinyl seat covers rear seat, doeskin with white piping	1	
3	423298	Vinyl seat covers rear seat, eige with white piping	1	
3	434282	Vinyl seat covers rear seat, tan with white piping.	1	
3	434283	Vinyl seat covers rear seat, midnight blue with white piping	1	
3	435375	Vinyl seat covers rear seat, dove grey with white piping	1	
3	435376	Leather seat covers rear seat, black with black piping	1	
3	435381	Leather seat covers rear seat, black with white piping	1	
3	435384	Leather seat covers rear seat, black with red piping	1	
3	455179	Leather seat covers rear seat, cherokee red with white piping	1	
3	455410	Leather seat covers rear seat, matador red with white piping	1	
3	455463	Leather seat covers rear seat, doeskin with white piping	1	
3	455562	Leather seat covers rear seat, beige with white piping	1	
3	456150	Leather seat covers rear seat, tan with white piping.	1	
3	456152	Leather seat covers rear seat, light tan with light tan piping	1	
3	456386	Leather seat covers rear seat, midnight blue with white piping	1	
3	457136	Leather seat covers rear seat, dove grey with white piping	1	
3	436672	Rear seat vinyl, black with white piping.	1	
3	436674	Rear seat vinyl, cherokee red with white piping	1	
3	436685	Rear seat vinyl, matador red with white piping.	1	
3	436686	Rear seat vinyl, doeskin with white piping.	1	
3	436687	Rear seat vinyl, beige with white piping.	1	
3	436701	Rear seat vinyl, tan with white piping	1	
3	436726	Rear seat vinyl, midnight blue with white piping.	1	
3	436730	Rear seat vinyl, dove grey with white piping	1	
3	423458	Rear seat leather, black with black piping	1	
3	436671	Rear seat leather, black with white piping	1	
3	436673	Rear seat leather, black with red piping	1	
3	436758	Rear seat leather, cherokee red with white piping.	1	
3	420853	Rear seat leather, matador red with white piping	1	
3	421858	Rear seat leather, doeskin with white piping	1	
3	422129	Rear seat leather, beige with white piping	1	
3	423303	Rear seat leather, tan with white piping.	1	
3	423304	Rear seat leather, light tan with light tan piping.	1	
3	423305	Rear seat leather, midnight blue with white piping	1	
3	423351	Rear seat leather, dove grey with white piping	1	

Note:
 Ask for f.o.c. colour samples.
 For details please look at the last page of this catalogue.

20.4

Seats and interior trim

Seats and seat covers - TR4 to middle of 1963

To chassis no. CT20876

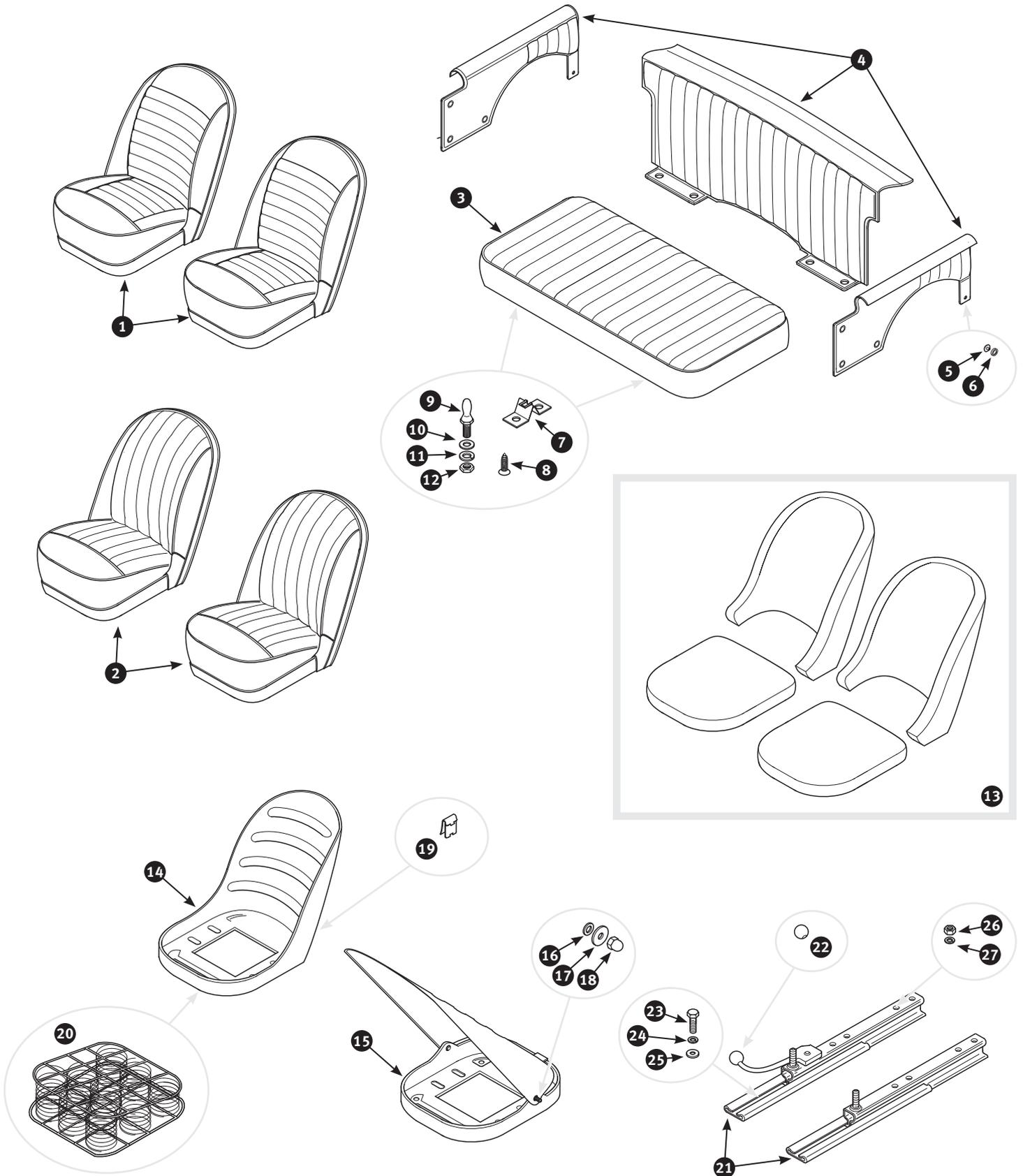

No	Part No	Description	Qty	Notes
4	328917	Hood frame covering kit vinyl, black with white piping	1	Soft top models only
4	379154	Hood frame covering kit vinyl, cherokee red with white piping	1	
4	319683	Hood frame covering kit vinyl, matador red with white piping	1	
4	388702	Hood frame covering kit vinyl, doeskin with white piping	1	
4	388703	Hood frame covering kit vinyl, beige with white piping	1	
4	388704	Hood frame covering kit vinyl, tan with white piping.	1	
4	312545	Hood frame covering kit vinyl, midnight blue with white piping	1	
4	388706	Hood frame covering kit vinyl, dove grey with white piping	1	
4	389127	Hood frame covering kit leather, black with black piping	1	
4	389128	Hood frame covering kit leather, black with white piping	1	
4	389139	Hood frame covering kit leather, black with red piping	1	
4	389138	Hood frame covering kit leather, cherokee red with white piping	1	
4	389145	Hood frame covering kit leather, matador red with white piping	1	
4	389151	Hood frame covering kit leather, doeskin with white piping	1	
4	389152	Hood frame covering kit leather, beige with white piping	1	
4	389224	Hood frame covering kit leather, tan with white piping.	1	
4	389246	Hood frame covering kit leather, light tan with light tan piping	1	
4	389248	Hood frame covering kit leather, midnight blue with white piping	1	
4	394297	Hood frame covering kit leather, dove grey with white piping	1	

Order free of charge:

Tuning catalogue

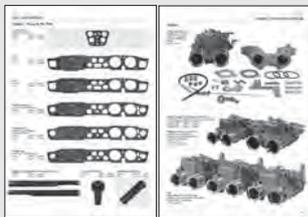

Order free of charge:

Accessories catalogue

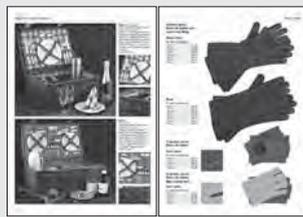

Note:

Ask for f.o.c. colour samples.
For details please look at the last page of this catalogue.

20.4

Seats and interior trim

Seats and seat covers - TR4 to middle of 1963

To chassis no. CT20876

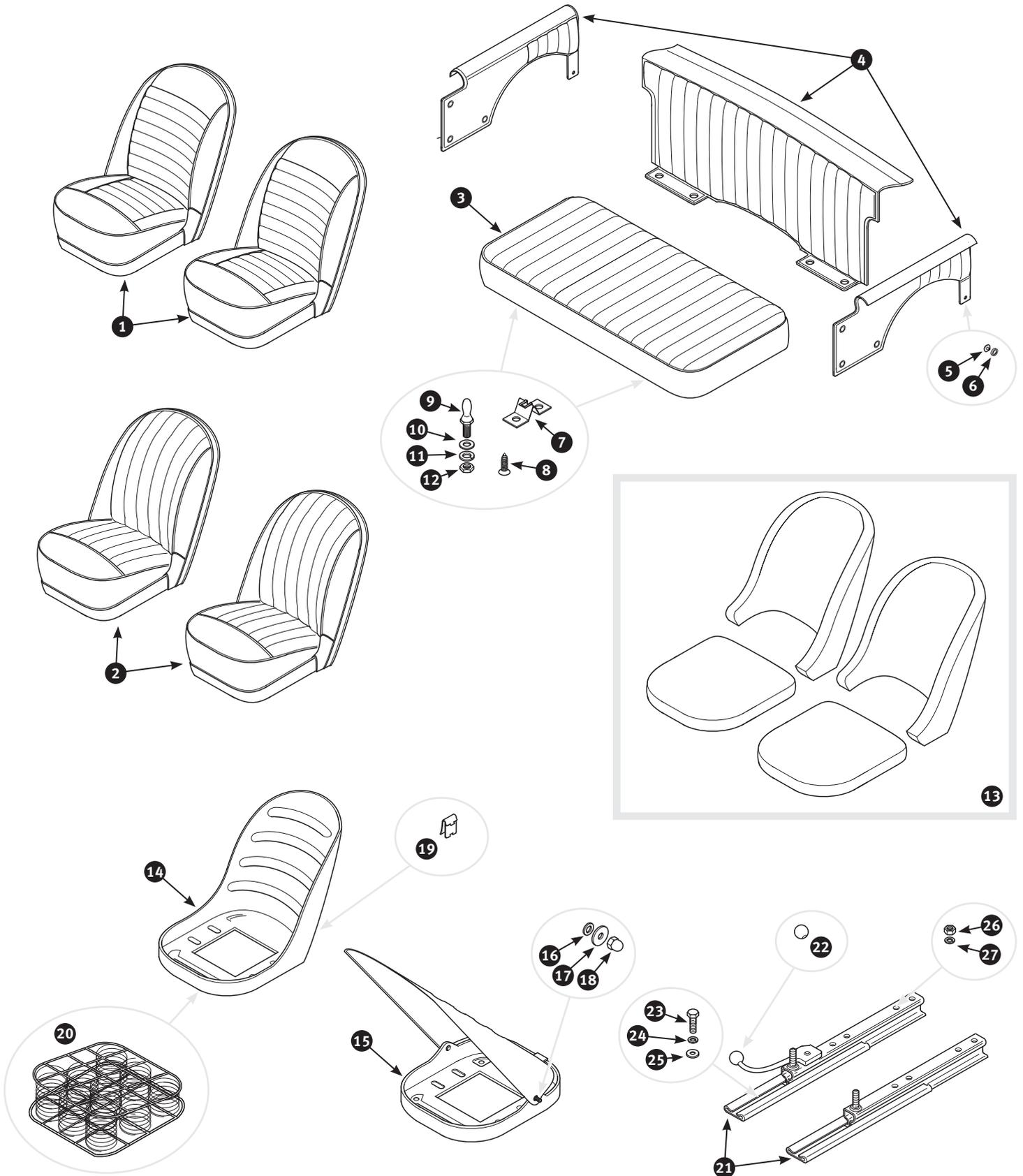

No	Part No	Description	Qty	Notes
5	4221	Durable dot button	12	} Fixed on hood frame covers
6	9306	Durable dot socket	12	
7	300730	Retainer	2	} Rear seat
8	300836	Wood screw	4	
9	326080	Cotter pin	2	
10	7793	Plain washer	2	
11	212190	Spring washer	2	
12	215477	Nut	2	
13	21453	Seat foam kit front seats	1	} Content: two seat face foams and two seat back foams
14	204252	Seat frame driver side. Identify by fixed back	1	
15	204253	Seat frame passenger side. Identify by tilt back	1	
16	3241	Plain washer	2	} Passenger seat only
17	10387	Plain washer chromed	2	
18	8493	Dome nut chromed - seat back to frame	2	} Quantity as required
19	11835	Retaining clip seat cover to seat frame	0	
20	12852	Spring core front seat	2	
21	21451	Seat runners LH front seat	1	} Supplied in sets of 4
21	21450	Seat runners RH front seat	1	
22	3651	Knob seat back release	2	
23	3072	Screw	8	} Seat runner to floor panel
24	212191	Plain washer	8	
25	6175	Spacing washer	8	
26	212451	Nyloc nut	8	} Seat runner to seat frame
27	212191	Plain washer	8	



Auto-Dehydrator

„Air Dry“ holds 600 g of water. No fogged up windows, rust, electric problems, mold, bad smell. Re-usable, just dry after 3 month. Dimensions: 30 x 14 x 9 cm, weight: 1 kg
Part no.246550

Note:

Ask for f.o.c. colour samples.
For details please look at the last page of this catalogue.

20.5

Seats and interior trim

Seats and seat covers - TR4 from middle of 1963

From chassis number CT20877

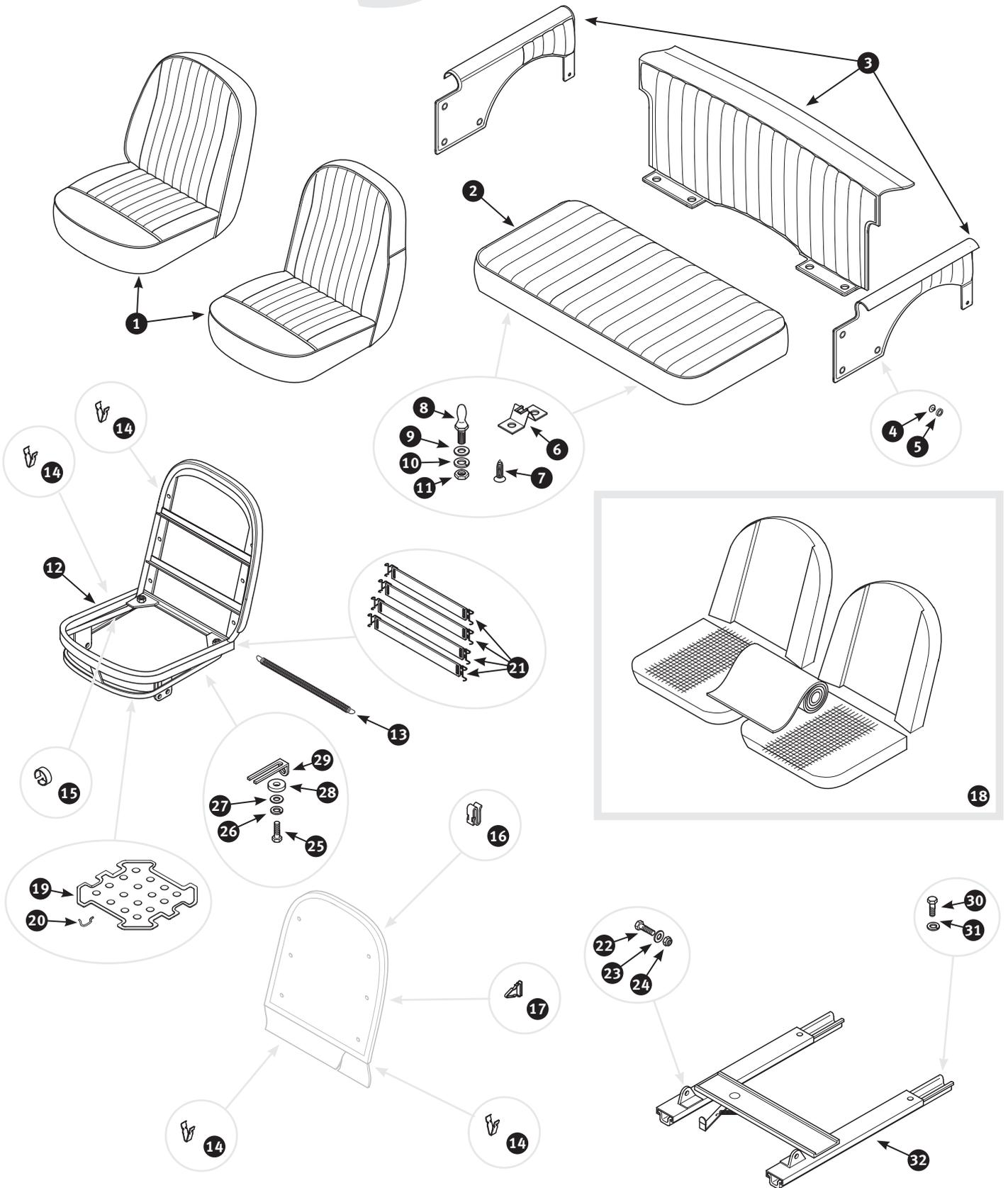

No	Part No	Description	Qty	Notes
1	16920	Vinyl seat covers front seats, black with white piping	1	
1	21471	Vinyl seat covers front seats, cherokee red with white piping	1	
1	457415	Vinyl seat covers front seats, matador red with white piping	1	
1	388705	Vinyl seat covers front seats, doeskin with white piping	1	
1	457818	Vinyl seat covers front seats, beige with white piping	1	
1	457847	Vinyl seat covers front seats, tan with white piping.	1	
1	21472	Vinyl seat covers front seats, midnight blue with white piping	1	
1	394298	Vinyl seat covers front seats, dove grey with white piping	1	
1	394306	Vinyl seat covers front seats, biscuit with biscuit piping	1	
1	394322	Leather seat covers front seats, black with black piping	1	
1	316626	Leather seat covers front seats, black with white piping	1	
1	394333	Leather seat covers front seats, black with red piping	1	
1	330904	Leather seat covers front seats, cherokee red with white piping	1	
1	394340	Leather seat covers front seats, matador red with white piping	1	
1	394346	Leather seat covers front seats, doeskin with white piping	1	
1	394347	Leather seat covers front seats, beige with white piping	1	
1	394348	Leather seat covers front seats, tan with white piping.	1	
1	394349	Leather seat covers front seats, light tan with light tan piping	1	
1	330905	Leather seat covers front seats, midnight blue with white piping	1	
1	394387	Leather seat covers front seats, dove grey with white piping	1	
1	394388	Leather seat covers front seats, biscuit with biscuit piping	1	

Note:
 Ask for f.o.c. colour samples.
 For details please look at the last page of this catalogue.

20.5

Seats and interior trim

Seats and seat covers - TR4 from middle of 1963

From chassis number CT20877

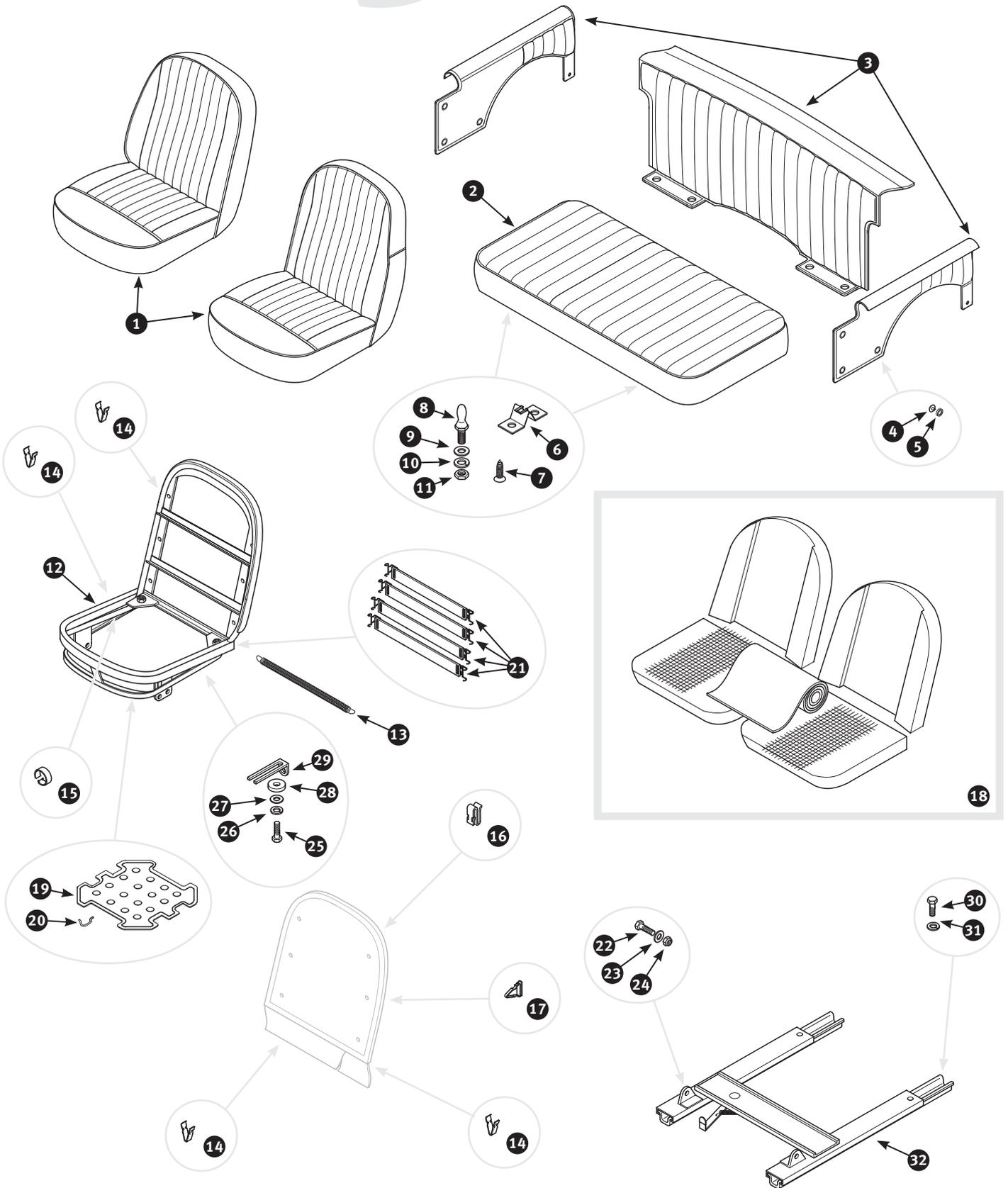

No	Part No	Description	Qty	Notes
2	423352	Vinyl seat covers rear seat, black with white piping	1	
2	423354	Vinyl seat covers rear seat, cherokee red with white piping	1	
2	423401	Vinyl seat covers rear seat, matador red with white piping	1	
2	423404	Vinyl seat covers rear seat, doeskin with white piping	1	
2	423298	Vinyl seat covers rear seat, beige with white piping	1	
2	434282	Vinyl seat covers rear seat, tan with white piping.	1	
2	434283	Vinyl seat covers rear seat, midnight blue with white piping	1	
2	435375	Vinyl seat covers rear seat, dove grey with white piping	1	
2	394327	Vinyl seat covers rear seat, biscuit with biscuit piping	1	
2	435376	Leather seat covers rear seat, black with black piping	1	
2	435381	Leather seat covers rear seat, black with white piping	1	
2	435384	Leather seat covers rear seat, black with red piping	1	
2	455179	Leather seat covers rear seat, cherokee red with white piping	1	
2	455410	Leather seat covers rear seat, matador red with white piping	1	
2	455463	Leather seat covers rear seat, doeskin with white piping	1	
2	455562	Leather seat covers rear seat, beige with white piping	1	
2	456150	Leather seat covers rear seat, tan with white piping.	1	
2	456152	Leather seat covers rear seat, light tan with light tan piping	1	
2	456386	Leather seat covers rear seat, midnight blue with white piping	1	
2	457136	Leather seat covers rear seat, dove grey with white piping	1	
2	341709	Leather seat covers rear seat, biscuit with biscuit piping	1	
2	436672	Rear seat vinyl, black with white piping.	1	
2	436674	Rear seat vinyl, cherokee red with white piping	1	
2	436685	Rear seat vinyl, matador red with white piping.	1	
2	436686	Rear seat vinyl, doeskin with white piping.	1	
2	436687	Rear seat vinyl, beige with white piping.	1	
2	436701	Rear seat vinyl, tan with white piping	1	
2	436726	Rear seat vinyl, midnight blue with white piping.	1	
2	436730	Rear seat vinyl, dove grey with white piping	1	
2	394313	Rear seat vinyl, biscuit with biscuit piping	1	
2	436671	Rear seat leather, black with white piping	1	
2	423458	Rear seat leather, black with black piping	1	
2	436673	Rear seat leather, black with red piping	1	
2	436758	Rear seat leather, cherokee red with white piping.	1	
2	420853	Rear seat leather, matador red with white piping	1	
2	421858	Rear seat leather, doeskin with white piping	1	
2	422129	Rear seat leather, beige with white piping	1	
2	423303	Rear seat leather, tan with white piping.	1	
2	423304	Rear seat leather, light tan with light tan piping	1	
2	423305	Rear seat leather, midnight blue with white piping	1	
2	423351	Rear seat leather, dove grey with white piping	1	
2	394352	Rear seat leather, biscuit with biscuit piping	1	

Note:
 Ask for f.o.c. colour samples.
 For details please look at the last page of this catalogue.

20.5

Seats and interior trim

Seats and seat covers - TR4 from middle of 1963

From chassis number CT20877

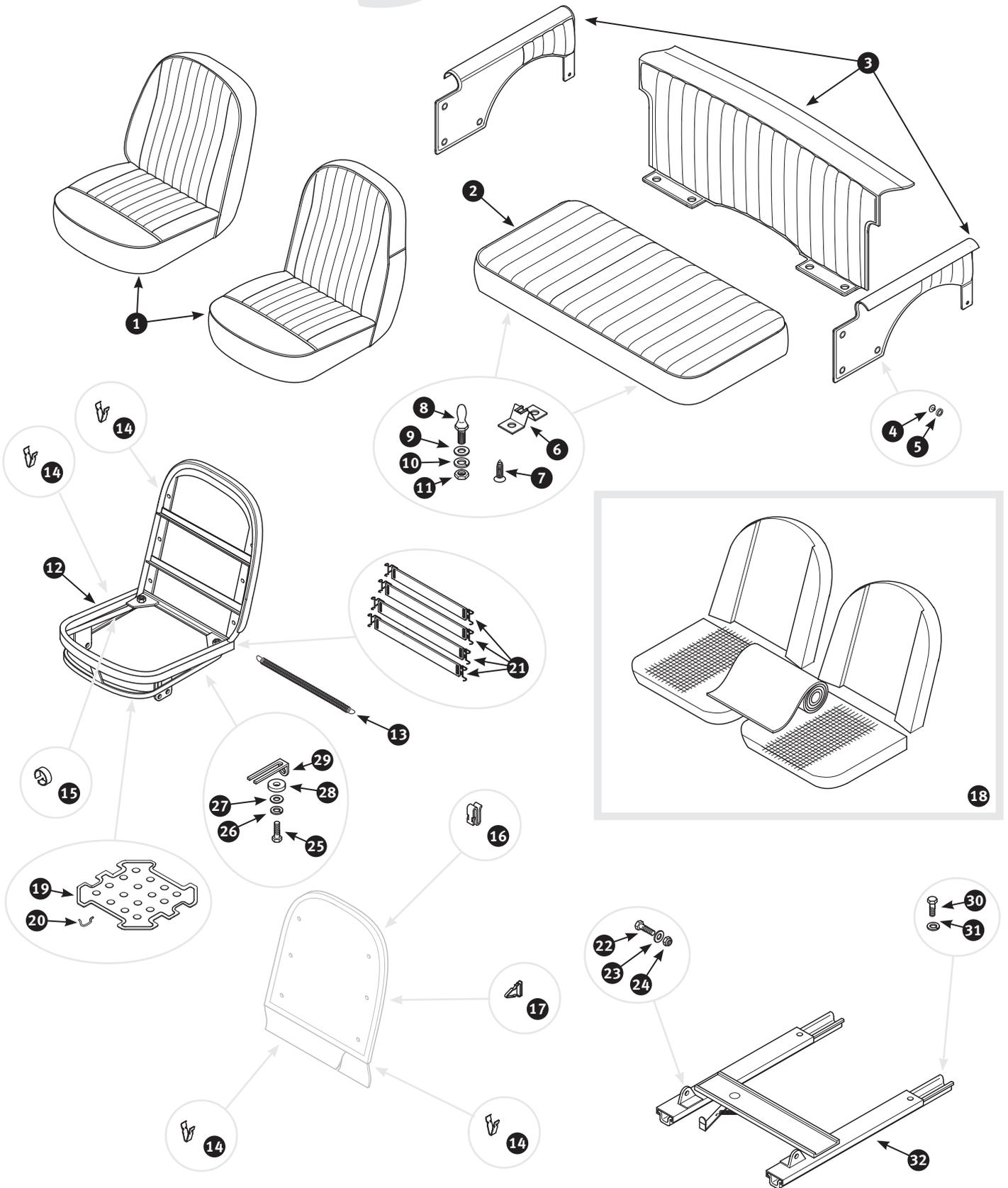

No	Part No	Description	Qty	Notes	
3	328917	Hood frame covering kit vinyl, black with white piping	1	} Soft top models only	
3	379154	Hood frame covering kit vinyl, cherokee red with white piping	1		
3	319683	Hood frame covering kit vinyl, matador red with white piping	1		
3	388702	Hood frame covering kit vinyl, doeskin with white piping	1		
3	388703	Hood frame covering kit vinyl, beige with white piping	1		
3	388704	Hood frame covering kit vinyl, tan with white piping.	1		
3	312545	Hood frame covering kit vinyl, midnight blue with white piping	1		
3	388706	Hood frame covering kit vinyl, dove grey with white piping	1		
3	379261	Hood frame covering kit vinyl, biscuit with biscuit piping	1		
3	389127	Hood frame covering kit leather, black with black piping	1		
3	389128	Hood frame covering kit leather, black with white piping	1		
3	389139	Hood frame covering kit leather, black with red piping	1		
3	389138	Hood frame covering kit leather, cherokee red with white piping	1		
3	389145	Hood frame covering kit leather, matador red with white piping	1		
3	389151	Hood frame covering kit leather, doeskin with white piping	1		
3	389152	Hood frame covering kit leather, beige with white piping	1		
3	389224	Hood frame covering kit leather, tan with white piping.	1		
3	389246	Hood frame covering kit leather, light tan with light tan piping	1		
3	389248	Hood frame covering kit leather, midnight blue with white piping	1		
3	394297	Hood frame covering kit leather, dove grey with white piping	1		
3	294077	Hood frame covering kit leather, biscuit with biscuit piping	1		
4	4221	Durable dot button	12		} Fixed on hood frame covers
5	9306	Durable dot socket	12		
6	300730	Retainer	2		
7	300836	Wood screw	4		} Rear seat
8	326080	Cotter pin	2		
9	7793	Plain washer	2		
10	212190	Spring washer	2		
11	215477	Nut	2		
12	316605	Seat frame LH front seat	1		} Seat cover to seat frame
12	311020	Seat frame RH front seat	1		
13	294878	Spring seat cover tension.	2		
14	3964	Retaining clip	70		
15	3675	Retaining clip	4		

Note:
 Ask for f.o.c. colour samples.
 For details please look at the last page of this catalogue.

20.5

Seats and interior trim

Seats and seat covers - TR4 from middle of 1963

From chassis number CT20877

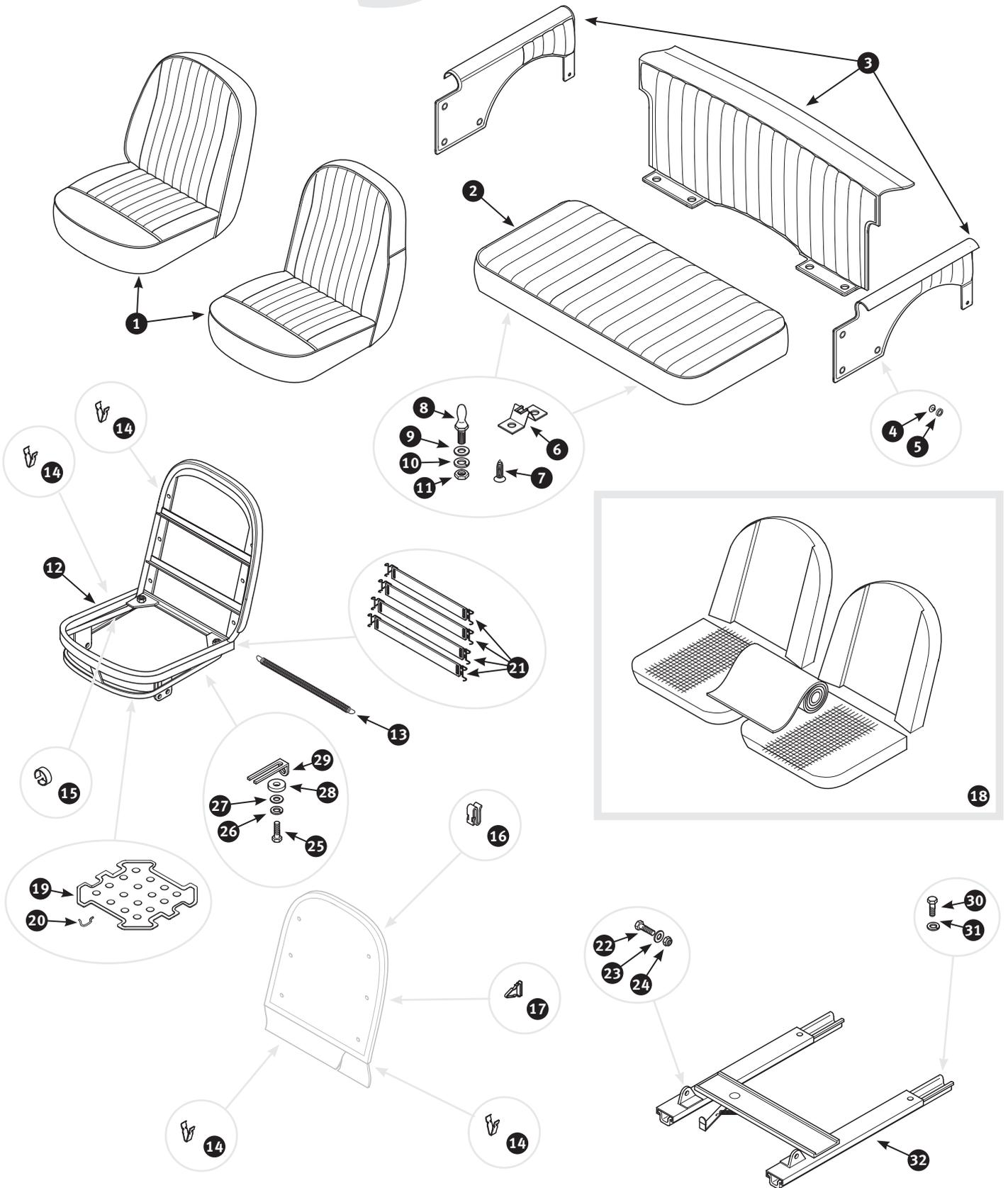

No	Part No	Description	Qty	Notes
16	10357	Retaining clip	6	} Seat back board to seat frame
17	205737	Retaining clip	12	
18	16924	Seat foam kit front seats	1	} Content: two seat face foams and two seat back foams
19	1805	Diaphragm seat base	2	} Seat frame to seat runner
20	1804	Hook diaphragm to seat frame	12	
21	21209	Webbing seat back - front seat	2	
22	7893	Screw	4	
23	9204	Plain washer	8	} Fixing seat runner stop and seat frame rebound buffer
24	2049	Nyloc nut	4	
25	300838	Screw	4	} Seat runner to floor panel
26	300778	Washer dished	4	
27	2831	Plain washer	6	
28	293704	Rebound buffer seat frame	4	
29	300777	Stop seat runner	2	} Seat runner to floor panel
30	3072	Screw	8	
31	212191	Plain washer	8	
32	21452	Seat runner	2	



316895	Leather seats complete with vinyl covered head rests, colour: black	1	} These seats come with four brackets to attach to the original seat runners - supplied in pairs
322434	Leather seats complete with vinyl covered head rests, colour: black with white piping	1	
323093	Leather seats complete with vinyl covered head rests, colour: black with red piping	1	
326378	Leather seats complete with vinyl covered head rests, colour: biscuit	1	

Note:
 Ask for f.o.c. colour samples.
 For details please look at the last page of this catalogue.

20.6

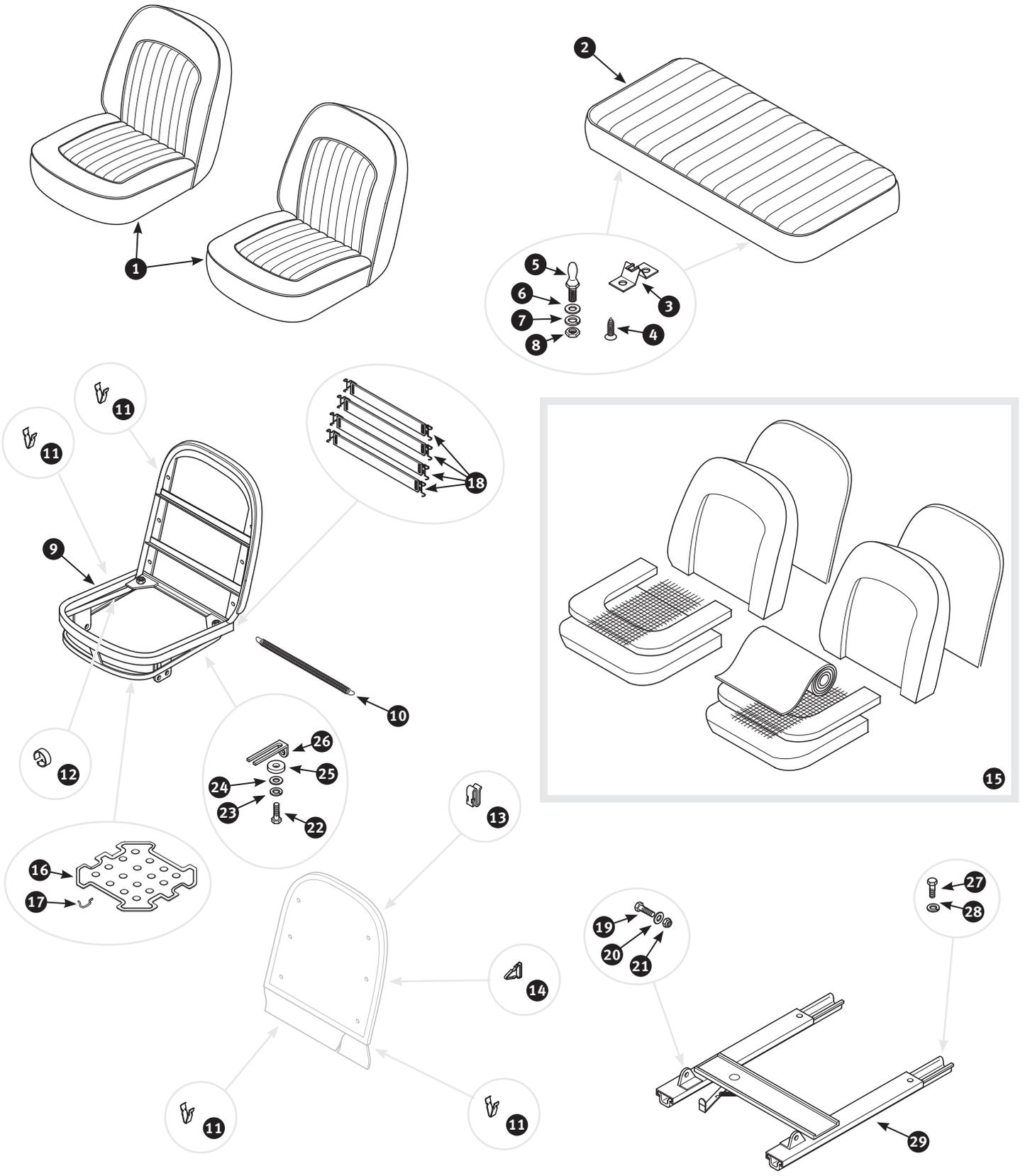

No	Part No	Description	Qty	Notes
1	15013	Vinyl seat covers front seats, black with white piping	1	
1	15162	Vinyl seat covers front seats, cherokee red with white piping	1	
1	395361	Vinyl seat covers front seats, matador red with white piping	1	
1	395362	Vinyl seat covers front seats, doeskin with white piping	1	
1	395365	Vinyl seat covers front seats, beige with white piping	1	
1	395367	Vinyl seat covers front seats, tan with white piping.	1	
1	15163	Vinyl seat covers front seats, midnight blue with white piping	1	
1	395373	Vinyl seat covers front seats, dove grey with white piping	1	
1	311019	Vinyl seat covers front seats, biscuit with biscuit piping	1	
1	395389	Leather seat covers front seats, black with black piping	1	
1	318635	Leather seat covers front seats, black with white piping	1	
1	395414	Leather seat covers front seats, black with red piping	1	
1	21508	Leather seat covers front seats, cherokee red with white piping	1	
1	395457	Leather seat covers front seats, matador red with white piping	1	
1	395463	Leather seat covers front seats, doeskin with white piping	1	
1	395464	Leather seat covers front seats, beige with white piping	1	
1	395466	Leather seat covers front seats, tan with white piping.	1	
1	395467	Leather seat covers front seats, light tan with light tan piping	1	
1	21509	Leather seat covers front seats, midnight blue with white piping	1	
1	395477	Leather seat covers front seats, dove grey with white piping	1	
1	395830	Leather seat covers front seats, biscuit with biscuit piping	1	

Note:
 Ask for f.o.c. colour samples.
 For details please look at the last page of this catalogue.

20.6

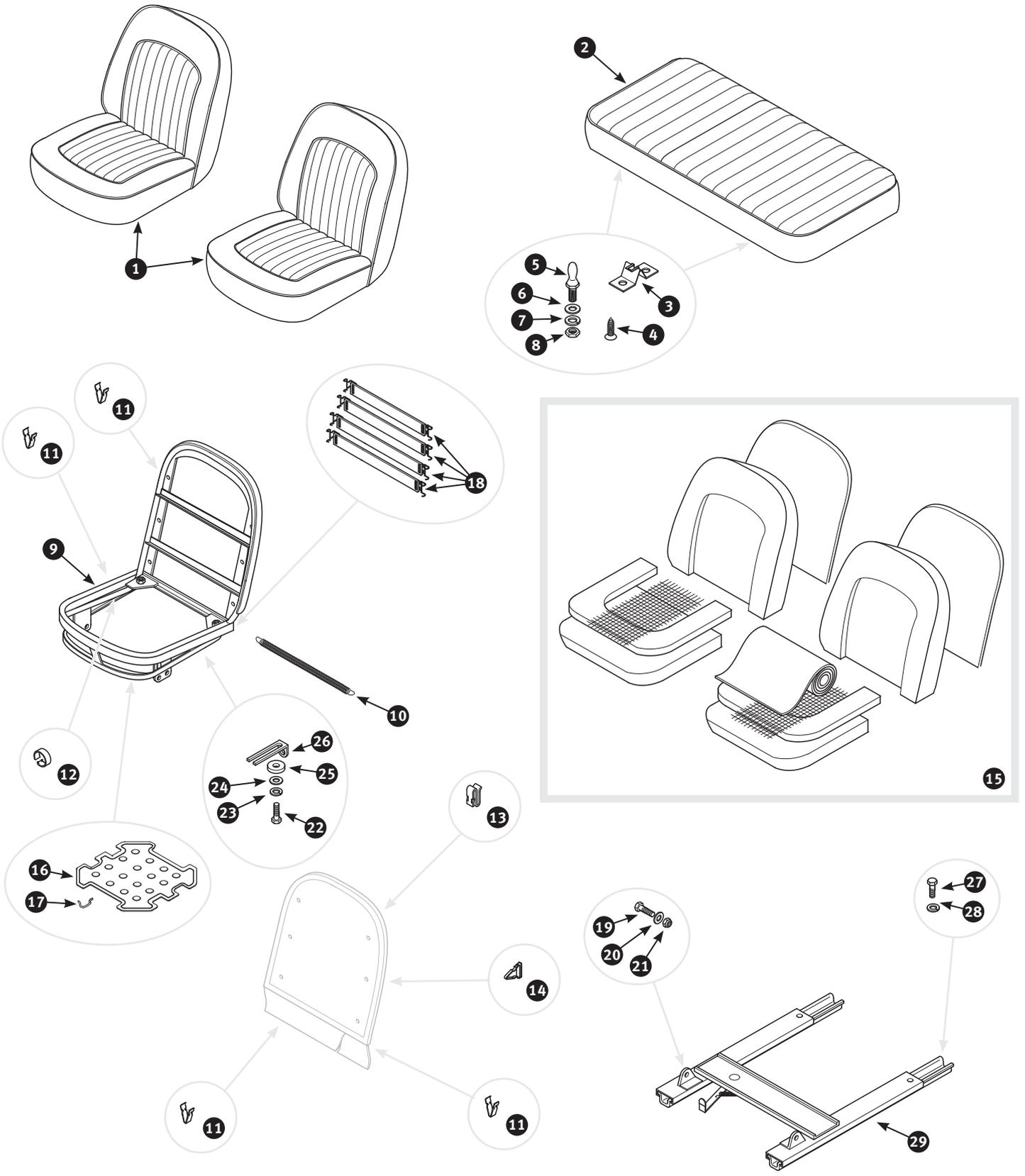

No	Part No	Description	Qty	Notes
2	423352	Vinyl seat covers rear seat, black with white piping	1	
2	423354	Vinyl seat covers rear seat, cherokee red with white piping	1	
2	423401	Vinyl seat covers rear seat, matador red with white piping	1	
2	423404	Vinyl seat covers rear seat, doeskin with white piping	1	
2	423298	Vinyl seat covers rear seat, beige with white piping	1	
2	434282	Vinyl seat covers rear seat, tan with white piping.	1	
2	434283	Vinyl seat covers rear seat, midnight blue with white piping	1	
2	435375	Vinyl seat covers rear seat, dove grey with white piping	1	
2	394327	Vinyl seat covers rear seat, biscuit with biscuit piping	1	
2	435376	Leather seat covers rear seat, black with black piping	1	
2	435381	Leather seat covers rear seat, black with white piping	1	
2	435384	Leather seat covers rear seat, black with red piping	1	
2	455179	Leather seat covers rear seat, cherokee red with white piping	1	
2	455410	Leather seat covers rear seat, matador red with white piping	1	
2	455463	Leather seat covers rear seat, doeskin with white piping	1	
2	455562	Leather seat covers rear seat, beige with white piping	1	
2	456150	Leather seat covers rear seat, tan with white piping.	1	
2	456152	Leather seat covers rear seat, light tan with light tan piping	1	
2	456386	Leather seat covers rear seat, midnight blue with white piping	1	
2	457436	Leather seat covers rear seat, dove grey with white piping	1	
2	341709	Leather seat covers rear seat, biscuit with biscuit piping	1	
2	436672	Rear seat vinyl, black with white piping.	1	
2	436674	Rear seat vinyl, cherokee red with white piping	1	
2	436685	Rear seat vinyl, matador red with white piping.	1	
2	436686	Rear seat vinyl, doeskin with white piping.	1	
2	436687	Rear seat vinyl, beige with white piping.	1	
2	436701	Rear seat vinyl, tan with white piping	1	
2	436726	Rear seat vinyl, midnight blue with white piping.	1	
2	436730	Rear seat vinyl, dove grey with white piping	1	
2	394313	Rear seat vinyl, biscuit with biscuit piping	1	
2	436671	Rear seat leather, black with white piping	1	
2	423458	Rear seat leather, black with black piping	1	
2	436673	Rear seat leather, black with red piping	1	
2	436758	Rear seat leather, cherokee red with white piping.	1	
2	420853	Rear seat leather, matador red with white piping	1	
2	421858	Rear seat leather, doeskin with white piping	1	
2	422129	Rear seat leather, beige with white piping	1	
2	423303	Rear seat leather, tan with white piping.	1	
2	423304	Rear seat leather, light tan with light tan piping	1	
2	423305	Rear seat leather, midnight blue with white piping	1	
2	423351	Rear seat leather, dove grey with white piping	1	
2	394352	Rear seat leather, biscuit with biscuit piping	1	

Note:
 Ask for f.o.c. colour samples. For details please look at the last page of this catalogue.

20.6

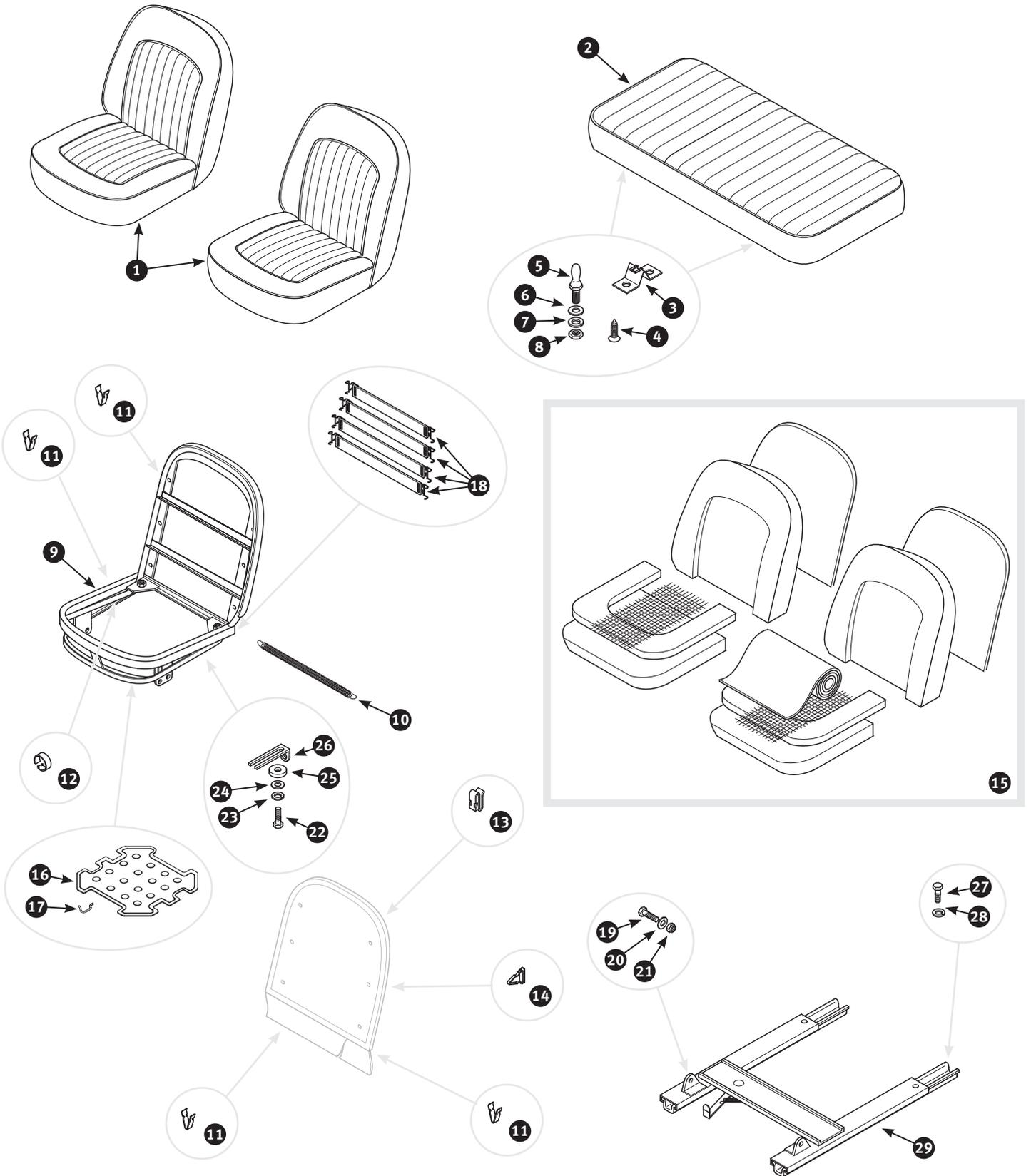

No	Part No	Description	Qty	Notes
3	300730	Retainer	2	Rear seat
4	300836	Wood screw	4	
5	326080	Cotter pin	2	
6	7793	Plain washer	2	
7	212190	Spring washer	2	
8	215477	Nut	2	
9	316605	Seat frame LH front seat	1	Seat cover to seat frame
9	311020	Seat frame RH front seat	1	
10	294878	Spring seat cover tension	2	Seat back board to seat frame
11	3964	Retaining clip	70	
12	3675	Retaining clip	4	
13	10357	Retaining clip	6	Content: two seat face foams and two seat back foams
14	205737	Retaining clip	12	
15	16924	Seat foam kit front seats	1	
16	1805	Diaphragm seat base	2	Seat frame to seat slide
17	1804	Hook diaphragm to seat frame	12	
18	21209	Webbing seat back - front seat	2	Fixing seat runner stop and seat frame rebound buffer
19	7893	Screw	4	
20	9204	Plain washer	8	Seat runner to floor panel
21	2049	Nyloc nut	4	
22	300838	Screw	4	Seat runner to floor panel
23	300778	Washer dished	4	
24	2831	Plain washer	6	
25	293704	Rebound buffer seat frame	4	
26	300777	Stop seat runner	2	
27	3072	Screw	8	
28	212191	Plain washer	8	
29	21452	Seat runner	2	



316895	Leather seats complete with vinyl covered head rests, colour: black	1	These seats come with four brackets to attach to the original seat runners - supplied in pairs
322434	Leather seats complete with vinyl covered head rests, colour: black with white piping	1	
323093	Leather seats complete with vinyl covered head rests, colour: black with red piping	1	
326378	Leather seats complete with vinyl covered head rests, colour: biscuit	1	

Note:
 Ask for f.o.c. colour samples.
 For details please look at the last page of this catalogue.

20.7

Seats and interior trim

Trim kits - TR2

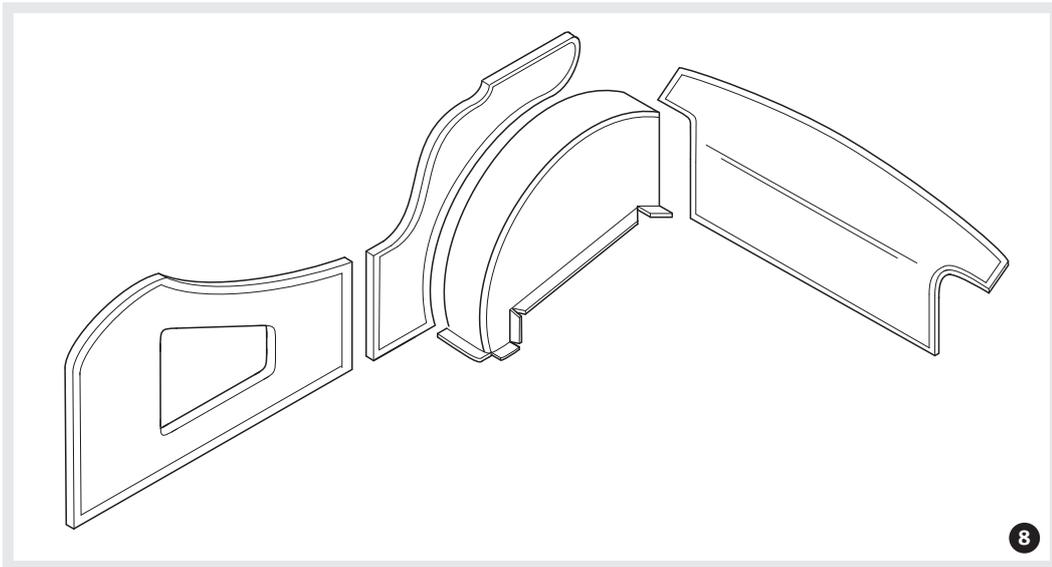
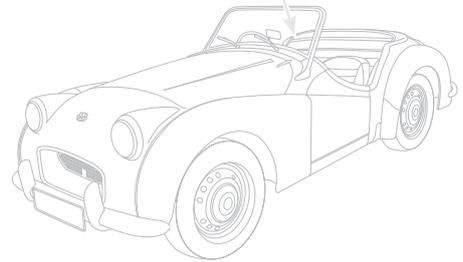
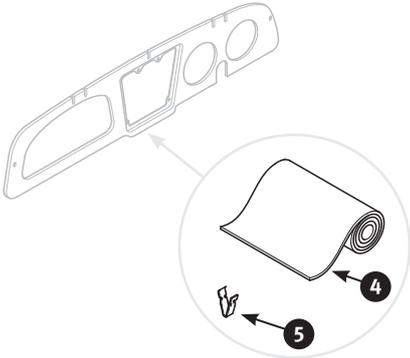
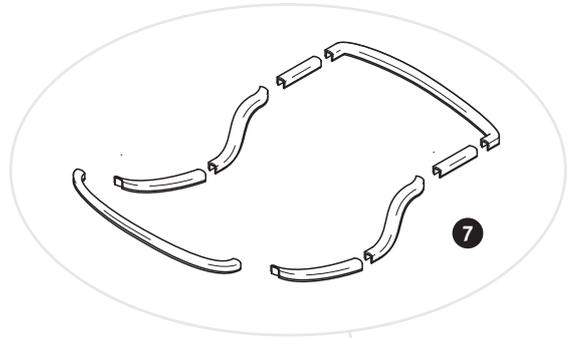
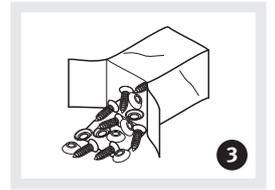
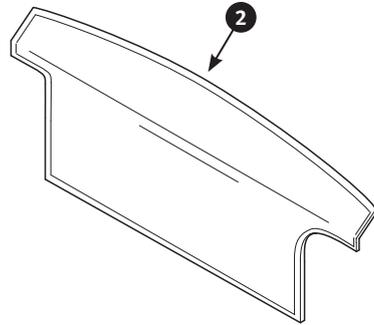
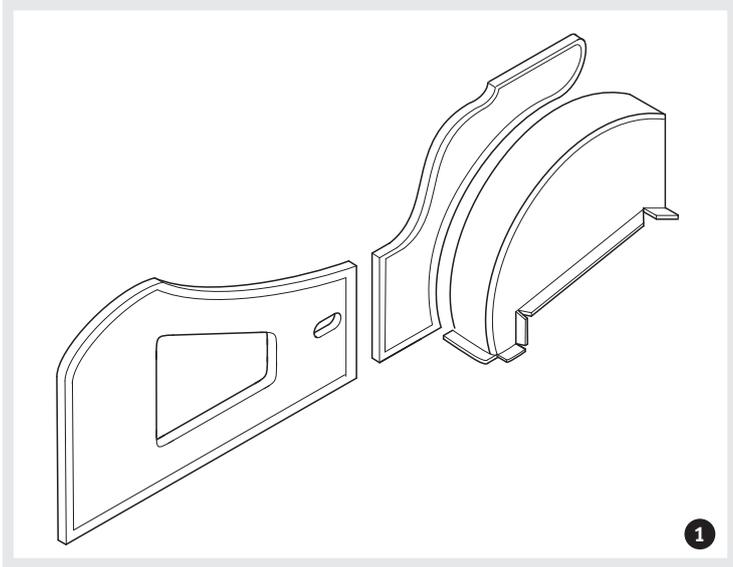

No	Part No	Description	Qty	Notes	
1	21513	Trim kit black	1	6 piece vinyl kit. In addition you need the rear cockpit panel (ill. 2)	
1	21514	Trim kit cherokee red	1		
1	395390	Trim kit doeskin	1		
1	319678	Trim kit tan	1		
1	21515	Trim kit midnight blue	1		
1	395387	Trim kit dove grey	1		
1	395424	Trim kit stone beige	1		
2	394440	Cockpit panel black	1		Vinyl
2	394465	Cockpit panel cherokee red	1		
2	394468	Cockpit panel doeskin	1		
2	394469	Cockpit panel midnight blue	1		
2	394472	Cockpit panel tan	1		
2	394476	Cockpit panel dove grey	1		
2	394488	Cockpit panel stone grey	1	Content: 50 chromed screws and cup washers	
3	15121	Fitting kit trim panels	1		
4	394489	Vinyl material dashboard, black	1		
4	394503	Vinyl material dashboard, cherokee red	1		
4	394505	Vinyl material dashboard, doeskin	1		
4	394511	Vinyl material dashboard, midnight blue	1		
4	394512	Vinyl material dashboard, tan	1		
4	394392	Vinyl material dashboard, dove grey	1		
4	394404	Vinyl material dashboard, stone beige	1		
5	11835	Retaining clip vinyl material on dashboard	10		
6	16109	Adhesive for trim panels - 750 ml can	1	Complete car set	
6	20056	Adhesive for trim panels - 400 ml aerosol	1		
7	394519	Vinyl material cockpit cappings, black	1		
7	394521	Vinyl material cockpit cappings, cherokee red	1		
7	394522	Vinyl material cockpit cappings, doeskin	1		
7	394527	Vinyl material cockpit cappings, midnight blue	1		
7	394531	Vinyl material cockpit cappings, tan	1		
7	6595	Vinyl material cockpit cappings, dove grey	1		
7	420277	Vinyl material cockpit cappings, stone beige	1		
7	329992	Leather material cockpit cappings, black	1		Complete car set
7	329993	Leather material cockpit cappings, cherokee red	1		
7	447018	Leather material cockpit cappings, doeskin	1		
7	447019	Leather material cockpit cappings, midnight blue	1		
7	329996	Leather material cockpit cappings, tan	1		
7	329995	Leather material cockpit cappings, dove grey	1		
7	329994	Leather material cockpit cappings, stone beige	1	7 piece leather kit (including rear cockpit panel)	
8	329929	Trim kit black	1		
8	329930	Trim kit cherokee red	1		
8	446996	Trim kit doeskin	1		
8	329933	Trim kit tan	1		
8	447000	Trim kit midnight blue	1		
8	329932	Trim kit dove grey	1		
8	329931	Trim kit stone beige	1		

Note:
 Ask for f.o.c. colour samples.
 For details please look at the last page of this catalogue.

20.8

Seats and interior trim

Trim kits - TR3

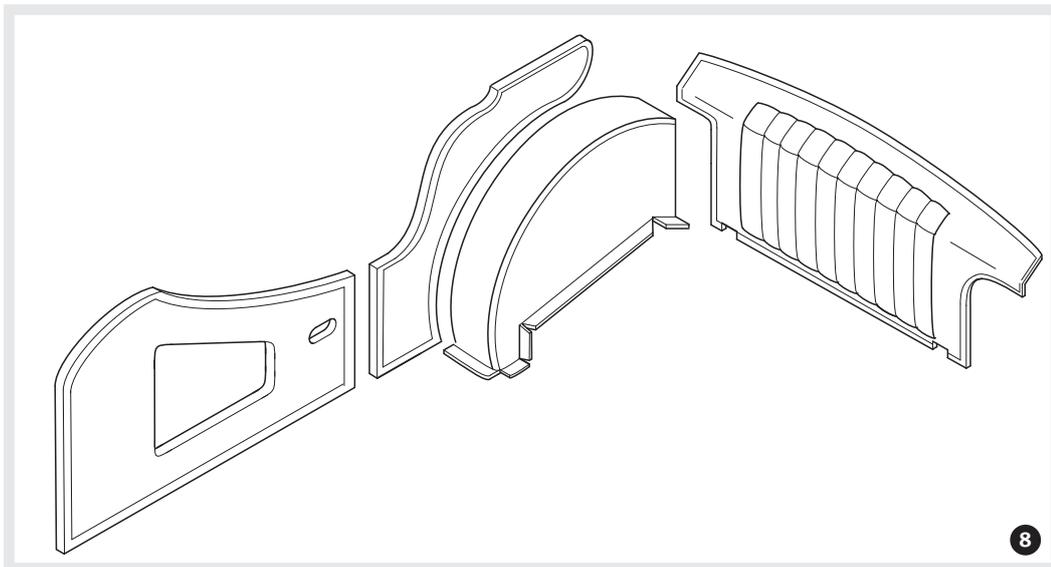
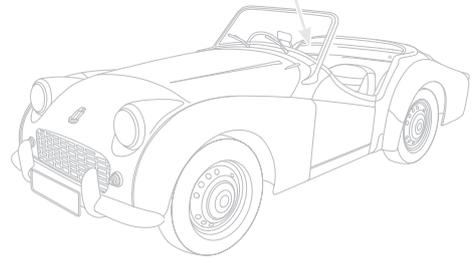
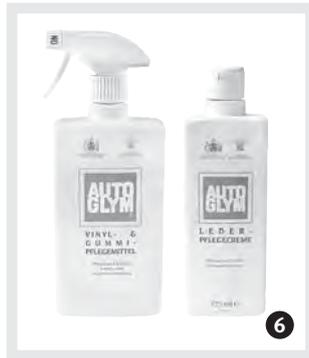
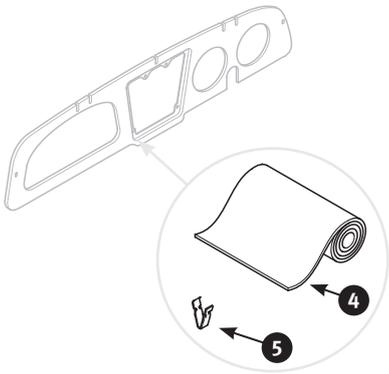
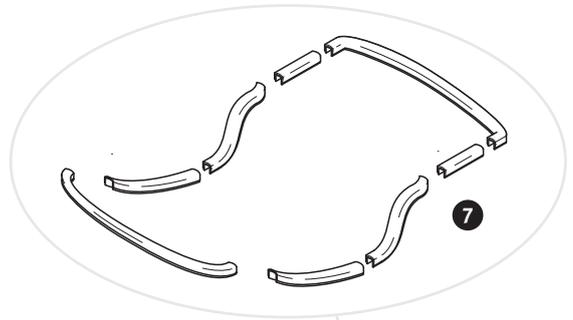
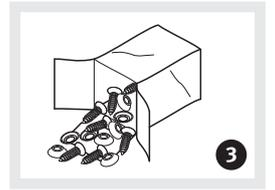
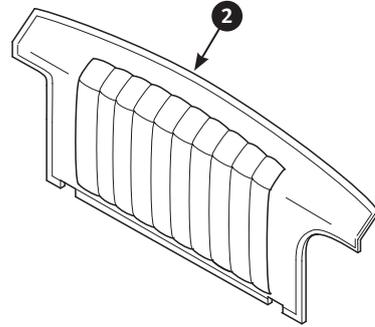
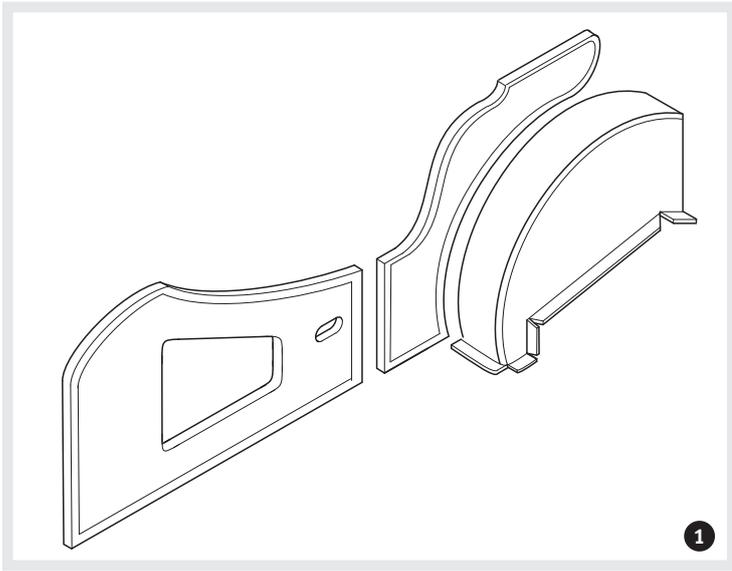

No	Part No	Description	Qty	Notes
1	21516	Trim kit black with white piping	1	6 piece vinyl kit. In addition you need the rear cockpit panel (ill. 2)
1	21517	Trim kit vinyl, cherokee red with white piping - 6 piece	1	
1	394668	Trim kit vinyl, matador red with white piping - 6 piece	1	
1	394559	Trim kit vinyl, doeskin with white piping - 6 piece	1	
1	394560	Trim kit vinyl, tan with white piping - 6 piece	1	
1	21518	Trim kit vinyl, midnight blue with white piping - 6 piece	1	
1	394585	Trim kit vinyl, dove grey with white piping - 6 piece	1	Vinyl
2	394586	Cockpit panel vinyl, black with white piping.	1	
2	330336	Cockpit panel vinyl, cherokee red with white piping	1	
2	394600	Cockpit panel vinyl, matador red with white piping.	1	
2	394606	Cockpit panel vinyl, doeskin with white piping.	1	
2	330339	Cockpit panel vinyl, tan with white piping	1	
2	394618	Cockpit panel vinyl, midnight blue with white piping	1	Content: 50 chromed screws and cup washers
2	330338	Cockpit panel vinyl, dove grey with white piping	1	
3	15121	Fitting kit trim panels.	1	Perfect to beautify and protect fascias, dash panels, vinyl door and seat facings and door rubber seals
4	394489	Vinyl material dashboard, black	1	
4	394503	Vinyl material dashboard, cherokee red	1	
4	394631	Vinyl material dashboard, matador red	1	
4	394505	Vinyl material dashboard, doeskin.	1	
4	394512	Vinyl material dashboard, tan	1	
4	394511	Vinyl material dashboard, midnight blue	1	
4	394392	Vinyl material dashboard, dove grey	1	
5	11835	Retaining clip vinyl material on dashboard.	10	
6	310442	Autoglym Vinyl and Rubber Care 500 ml pump spray	1	
6	310443	Autoglym Leather Care 325 ml bottle.	1	Complete car set
7	394519	Vinyl material cockpit cappings, black	1	
7	394521	Vinyl material cockpit cappings, cherokee red	1	
7	394632	Vinyl material cockpit cappings, matador red	1	
7	394522	Vinyl material cockpit cappings, doeskin	1	
7	394531	Vinyl material cockpit cappings, tan	1	
7	394527	Vinyl material cockpit cappings, midnight blue	1	
7	6595	Vinyl material cockpit cappings, dove grey.	1	Complete car set
7	329992	Leather material cockpit cappings, black	1	
7	329993	Leather material cockpit cappings, cherokee red.	1	
7	330420	Leather material cockpit cappings, matador red	1	
7	447018	Leather material cockpit cappings, doeskin	1	
7	329996	Leather material cockpit cappings, tan.	1	7 piece leather kit (including rear cockpit panel)
7	447019	Leather material cockpit cappings, midnight blue	1	
7	329995	Leather material cockpit cappings, dove grey	1	
8	330306	Trim kit black with white piping	1	
8	330307	Trim kit leather, cherokee red	1	
8	446981	Trim kit leather, matador red with white piping.	1	
8	446989	Trim kit leather, doeskin.	1	
8	330296	Trim kit leather, tan with white piping	1	
8	446998	Trim kit leather, midnight blue with white piping	1	
8	330295	Trim kit leather, dove grey with white piping	1	

Note:
 Ask for f.o.c. colour samples.
 For details please look at the last page of this catalogue.

20.9

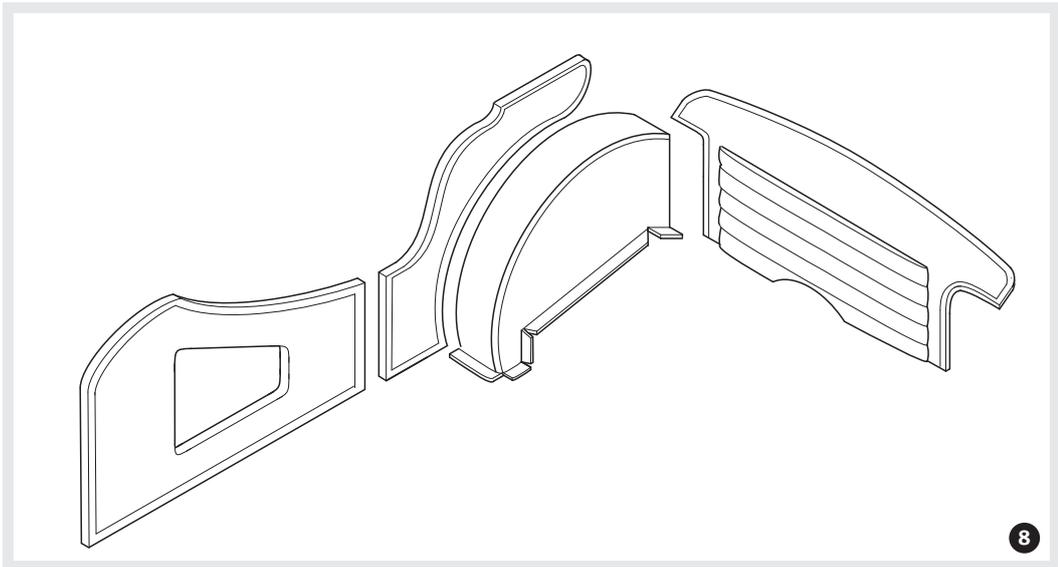
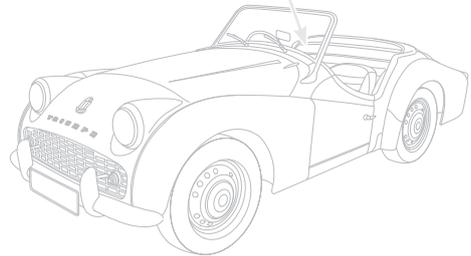
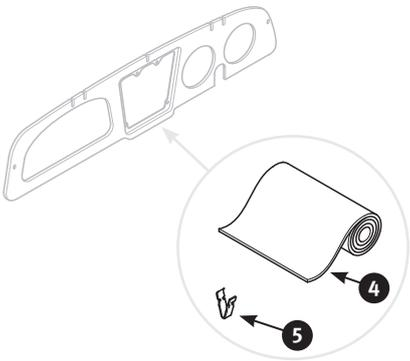
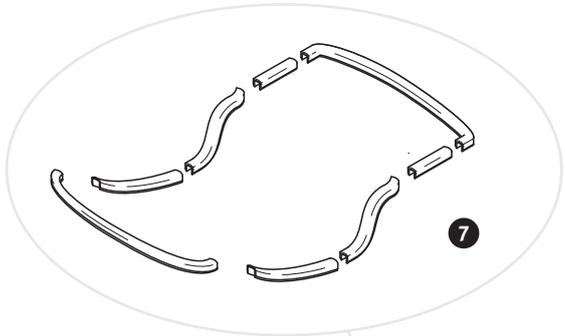
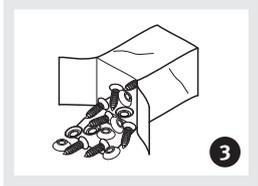
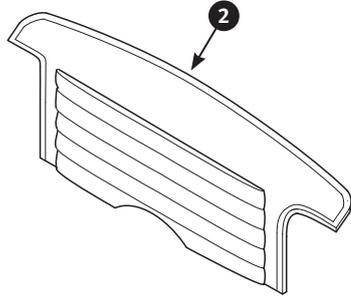
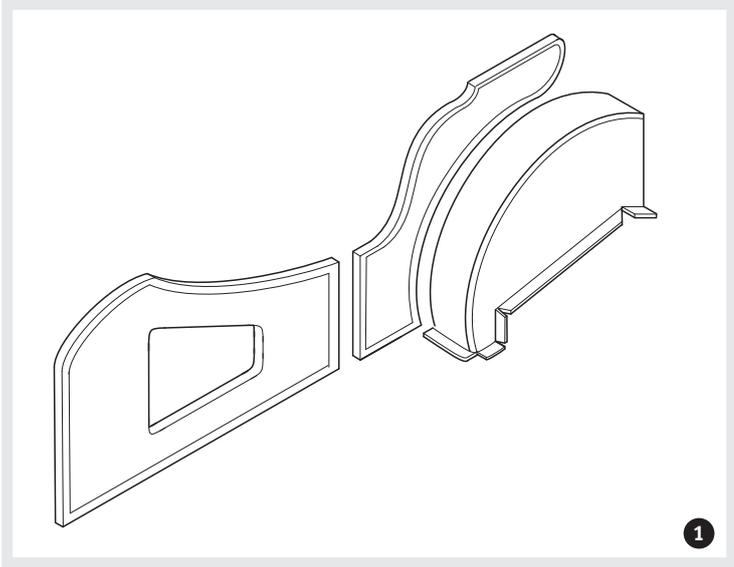

No	Part No	Description	Qty	Notes
1	21519	Trim kit black with white piping	1	6 piece vinyl kit. In addition you need the rear cockpit panel (ill. 2)
1	21520	Trim kit cherokee red with white piping	1	
1	330293	Trim kit matador red with white piping	1	
1	330294	Trim kit doeskin with white piping	1	
1	394540	Trim kit beige with white piping	1	
1	330419	Trim kit tan with white piping	1	
1	21521	Trim kit midnight blue with white piping	1	
1	330418	Trim kit dove grey with white piping	1	
2	330482	Cockpit panel black with white piping	1	
2	330476	Cockpit panel cherokee red with white piping	1	
2	330337	Cockpit panel matador red with white piping	1	Vinyl
2	394619	Cockpit panel doeskin with white piping	1	
2	394613	Cockpit panel beige white piping	1	
2	330479	Cockpit panel tan with white piping	1	
2	330480	Cockpit panel midnight blue with white piping	1	
2	330478	Cockpit panel dove grey with white piping	1	
3	15121	Fitting kit trim panels.	1	
4	394489	Vinyl material dashboard, black	1	
4	394503	Vinyl material dashboard, cherokee red	1	
4	394631	Vinyl material dashboard, matador red	1	
4	394505	Vinyl material dashboard, doeskin.	1	
4	300817	Vinyl material dashboard, beige	1	
4	394512	Vinyl material dashboard, tan	1	
4	394511	Vinyl material dashboard, midnight blue	1	
4	394392	Vinyl material dashboard, dove grey	1	
5	11835	Retaining clip vinyl material on dashboard.	10	
6	355874	Connolly Leather care kit content: 500 ml leather cleaner and 284 ml hide care waxy cream	1	
7	394519	Vinyl material cockpit cappings, black	1	Complete car set
7	394521	Vinyl material cockpit cappings, cherokee red	1	
7	394632	Vinyl material cockpit cappings, matador red	1	
7	394522	Vinyl material cockpit cappings, doeskin	1	
7	396818	Vinyl material cockpit cappings, beige	1	
7	394531	Vinyl material cockpit cappings, tan	1	
7	394527	Vinyl material cockpit cappings, midnight blue	1	
7	6595	Vinyl material cockpit cappings, dove grey.	1	Complete car set
7	329992	Leather material cockpit cappings, black	1	
7	329993	Leather material cockpit cappings, cherokee red.	1	
7	330420	Leather material cockpit cappings, matador red	1	
7	447018	Leather material cockpit cappings, doeskin	1	
7	446977	Leather material cockpit cappings, beige	1	
7	329996	Leather material cockpit cappings, tan.	1	
7	447019	Leather material cockpit cappings, midnight blue	1	
7	329995	Leather material cockpit cappings, dove grey	1	
8	330435	Trim kit black with white piping	1	7 piece leather kit (including rear cockpit panel)
8	330436	Trim kit cherokee red with white piping	1	
8	446695	Trim kit matador red with white piping	1	
8	446721	Trim kit doeskin with white piping	1	
8	446884	Trim kit beige with white piping	1	
8	446827	Trim kit tan with white piping	1	
8	330440	Trim kit midnight blue with white piping	1	
8	330438	Trim kit dove grey with white piping	1	

Note:
Ask for f.o.c. colour samples.
For details please look at the last page of this catalogue.

20.10

Seats and interior trim Trim kits - TR3A from TS60001, TR3B

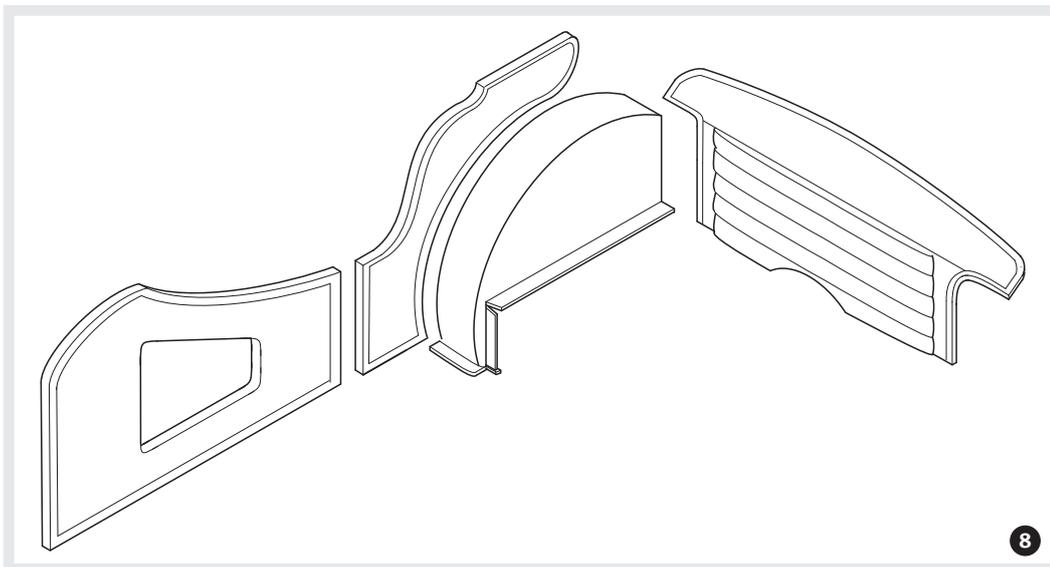
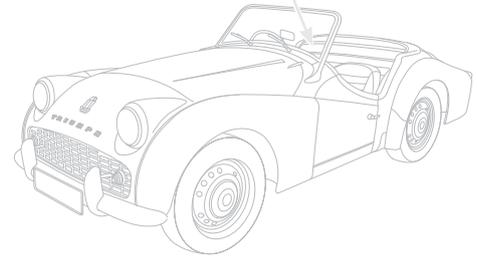
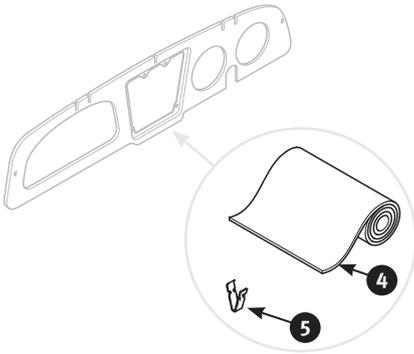
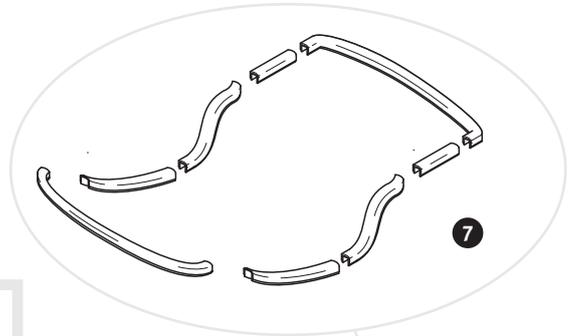
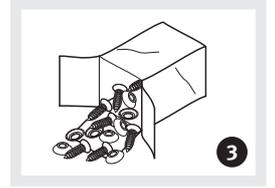
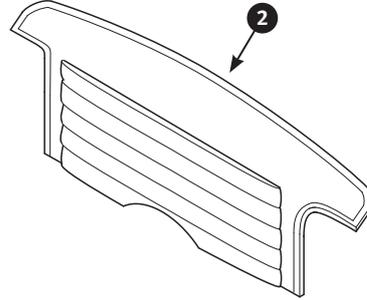
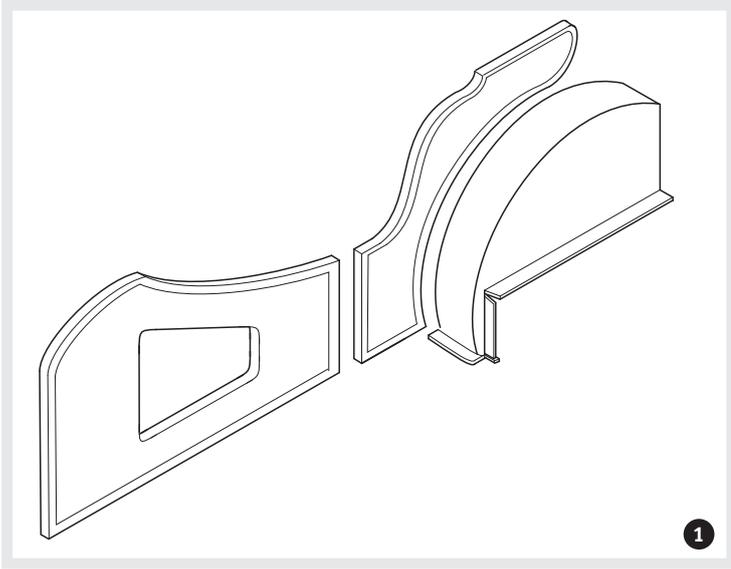

No	Part No	Description	Qty	Notes
1	21522	Trim kit black with white piping	1	6 piece vinyl kit. In addition you need the rear cockpit panel (ill. 2)
1	21523	Trim kit cherokee red with white piping	1	
1	330292	Trim kit matador red with white piping	1	
1	312094	Trim kit rdoeskin with white piping	1	
1	394587	Trim kit beige white piping	1	
1	330335	Trim kit tan with white piping	1	
1	330427	Trim kit midnight blue with white piping	1	
1	330425	Trim kit dove grey with white piping	1	
2	330475	Cockpit panel black	1	
2	330483	Cockpit panel cherokee red	1	
2	446493	Cockpit panel matador red	1	Vinyl
2	446500	Cockpit panel doeskin	1	
2	446504	Cockpit panel beige	1	
2	330486	Cockpit panel tan	1	
2	446529	Cockpit panel midnight blue	1	
2	446530	Cockpit panel dove grey	1	
3	15121	Fitting kit trim panels.	1	
4	394489	Vinyl material dashboard, black	1	
4	394503	Vinyl material dashboard, cherokee red	1	
4	394631	Vinyl material dashboard, matador red	1	
4	394505	Vinyl material dashboard, doeskin.	1	
4	300817	Vinyl material dashboard, beige	1	
4	394512	Vinyl material dashboard, tan	1	
4	394511	Vinyl material dashboard, midnight blue	1	
4	394392	Vinyl material dashboard, dove grey	1	
5	11835	Retaining clip vinyl material on dashboard.	10	
6	310221	Gliptone Liquid Leather Cleaner 250 ml bottle	1	
6	310220	Gliptone Leather Care 250 ml bottle	1	
7	394519	Vinyl material cockpit cappings, black	1	Complete car set
7	394521	Vinyl material cockpit cappings, cherokee red	1	
7	394632	Vinyl material cockpit cappings, matador red	1	
7	394522	Vinyl material cockpit cappings, doeskin	1	
7	396818	Vinyl material cockpit cappings, beige	1	
7	394531	Vinyl material cockpit cappings, tan	1	
7	394527	Vinyl material cockpit cappings, midnight blue	1	
7	6595	Vinyl material cockpit cappings, dove grey	1	Complete car set
7	329992	Leather material cockpit cappings, black	1	
7	329993	Leather material cockpit cappings, cherokee red	1	
7	330420	Leather material cockpit cappings, matador red	1	
7	447018	Leather material cockpit cappings, doeskin	1	
7	446977	Leather material cockpit cappings, beige	1	
7	329996	Leather material cockpit cappings, tan.	1	
7	447019	Leather material cockpit cappings, midnight blue	1	
7	329995	Leather material cockpit cappings, dove grey	1	
8	315478	Trim kit black with white piping	1	7 piece leather kit (including rear cockpit panel)
8	330442	Trim kit cherokee red with white pipingce	1	
8	446960	Trim kit matador red with white piping	1	
8	446961	Trim kit doeskin with white piping	1	
8	446967	Trim kit leather, beige with white piping	1	
8	446972	Trim kit tan with white piping	1	
8	330446	Trim kit leather, midnight blue with white piping	1	
8	330444	Trim kit dove grey with white piping	1	

Note:
 Ask for f.o.c. colour samples.
 For details please look at the last page of this catalogue.

20.11

Seats and interior trim

Trim kits - TR4

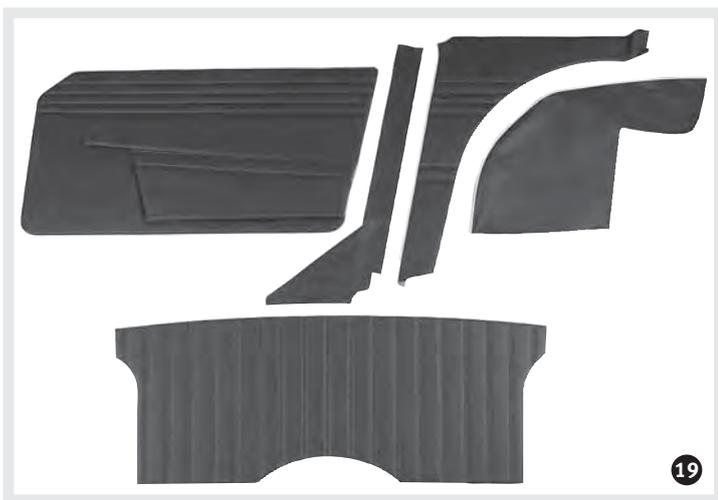
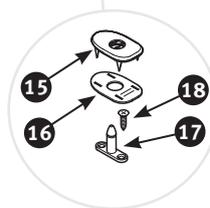
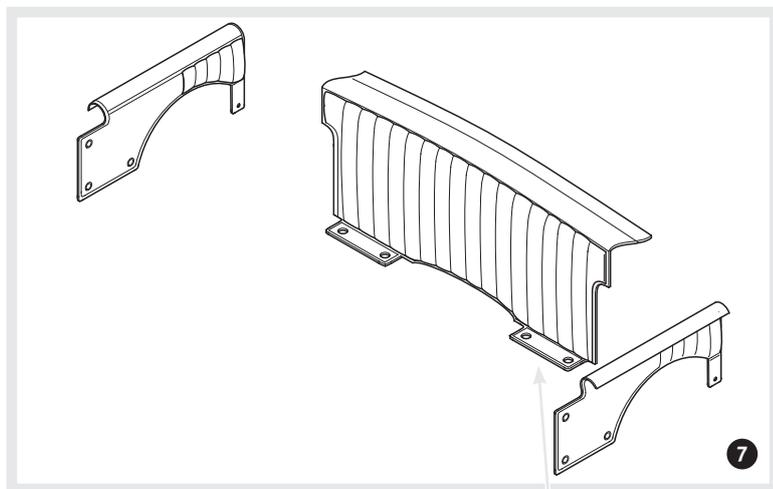
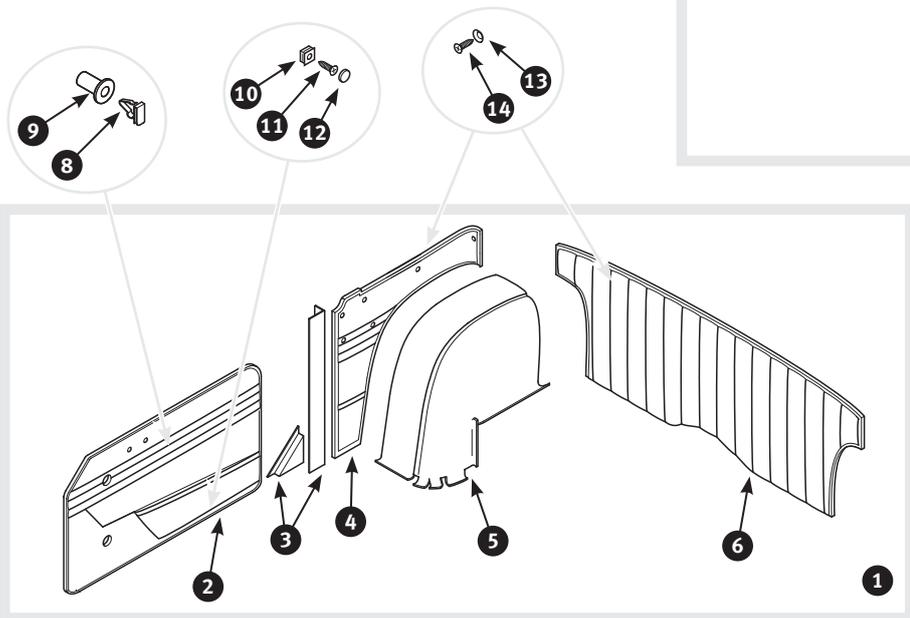

No	Part No	Description	Qty	Notes
1	21525	Trim kit black with white piping	1	9 piece vinyl kit. Soft top models need in addition our hood frame covering kit (ill. 7)
1	330799	Trim kit cherokee red with white piping	1	
1	21526	Trim kit matador red with white piping	1	
1	315281	Trim kit doeskin with white piping	1	
1	330641	Trim kit beige with white piping	1	
1	330422	Trim kit tan with white piping	1	
1	330802	Trim kit midnight blue with white piping	1	
1	447020	Trim kit dove grey with white piping	1	
1	447044	Trim kit biscuit with biscuit piping	1	
2	328075	Door panels black with white piping	1	2 piece vinyl kit
2	315914	Door panels cherokee red with white piping	1	
2	447056	Door panels matador red with white piping	1	
2	447060	Door panels doeskin with white piping	1	
2	447045	Door panels beige with white piping	1	
2	447048	Door panels tan with white piping	1	
2	330819	Door panels midnight blue with white piping	1	
2	307901	Door panels dove grey with white piping	1	
2	448683	Door panels biscuit with biscuit piping	1	
3	307825	Vinyl material ,B' post, black	1	4 piece kit
3	2226	Vinyl material ,B' post, cherokee red	1	
3	307828	Vinyl material ,B' post, matador red	1	
3	204205	Vinyl material ,B' post, doeskin	1	
3	330182	Vinyl material ,B' post, beige	1	
3	330181	Vinyl material ,B' post, tan	1	
3	330603	Vinyl material ,B' post, midnight blue	1	
3	22897	Vinyl material ,B' post, dove grey	1	
3	301941	Vinyl material ,B' post, biscuit with biscuit piping	1	
4	330794	Rear wheel arch panels black with white piping	1	2 piece vinyl kit
4	295389	Rear wheel arch panels cherokee red with white piping	1	
4	300784	Rear wheel arch panels matador red with white piping	1	
4	302397	Rear wheel arch panels doeskin with white piping	1	
4	395910	Rear wheel arch panels beige with white piping	1	
4	395911	Rear wheel arch panels tan with white piping	1	
4	395916	Rear wheel arch panels midnight blue with white piping	1	
4	395917	Rear wheel arch panels dove grey with white piping	1	
4	395923	Rear wheel arch panels biscuit with biscuit piping	1	
5	328916	Vinyl material rear wheel arch, black with white piping	1	2 piece kit
5	330844	Vinyl material rear wheel arch, cherokee red with white piping	1	
5	330843	Vinyl material rear wheel arch, matador red with white piping	1	
5	459685	Vinyl material rear wheel arch, doeskin with white piping	1	
5	459686	Vinyl material rear wheel arch, beige with white piping	1	
5	459716	Vinyl material rear wheel arch, tan with white piping	1	
5	330847	Vinyl material rear wheel arch, midnight blue with white piping	1	
5	446940	Vinyl material rear wheel arch, dove grey with white piping	1	
5	446949	Vinyl material rear wheel arch, biscuit with biscuit piping	1	

Note:
 Ask for f.o.c. colour samples.
 For details please look at the last page of this catalogue.

20.11

Seats and interior trim

Trim kits - TR4

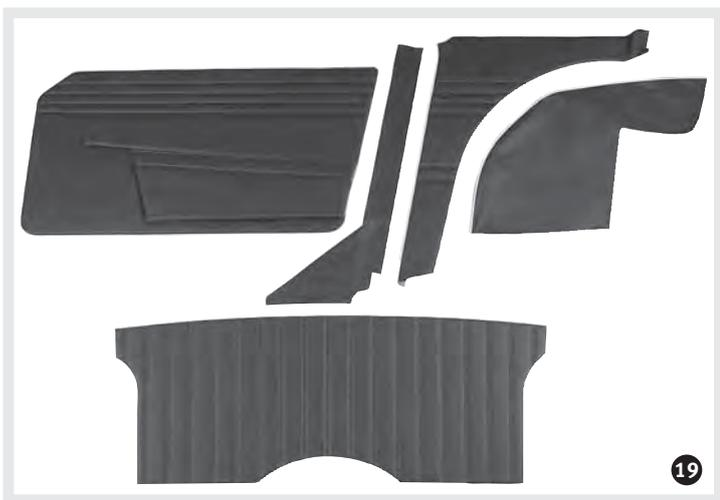
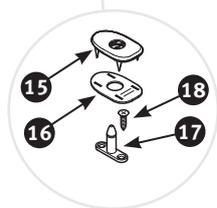
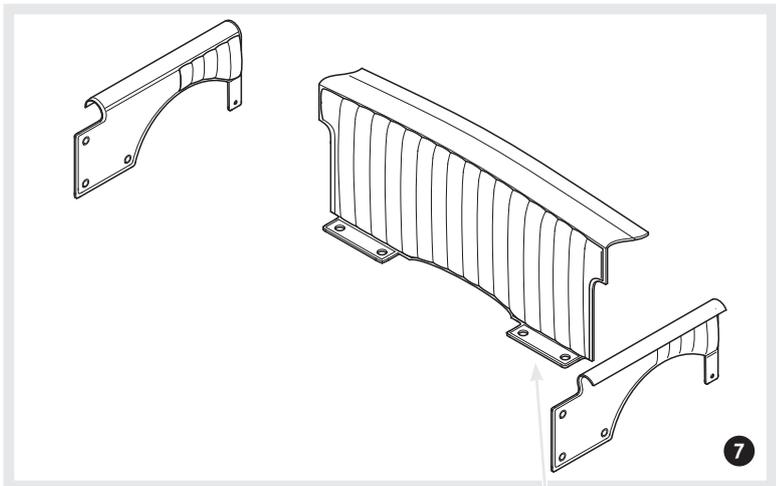
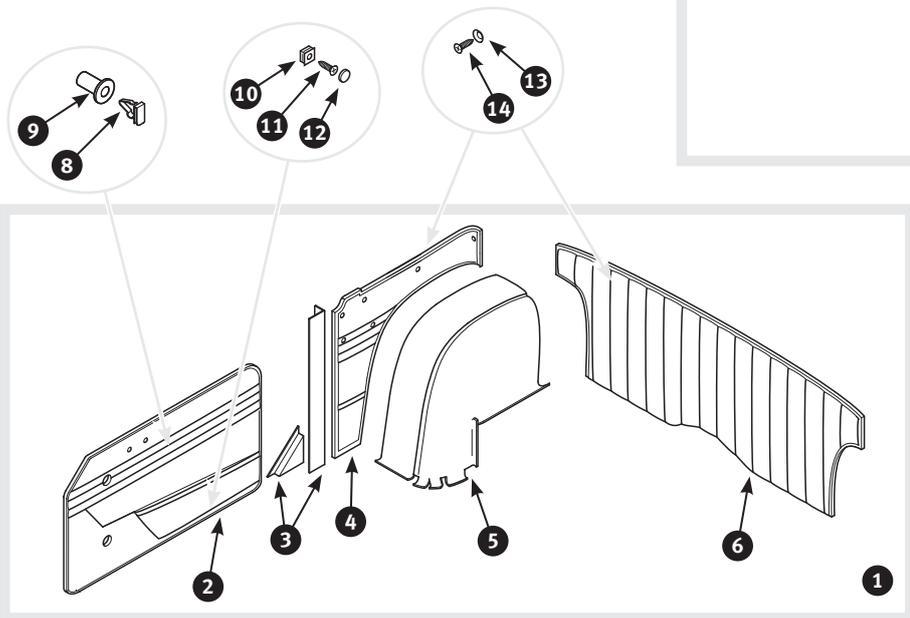

No	Part No	Description	Qty	Notes
6	319376	Cockpit panel black	1	Vinyl
6	330838	Cockpit panel cherokee red	1	
6	330837	Cockpit panel matador red with	1	
6	395926	Cockpit panel doeskin	1	
6	462075	Cockpit panel beige	1	
6	446511	Cockpit panel tan	1	
6	330841	Cockpit panel midnight blue	1	
6	446491	Cockpit panel dove grey	1	
6	446652	Cockpit panel biscuit	1	
7	328917	Hood frame covering kit vinyl, black with white piping	1	
7	379154	Hood frame covering kit vinyl, cherokee red with white piping	1	
7	319683	Hood frame covering kit vinyl, matador red with white piping	1	
7	388702	Hood frame covering kit vinyl, doeskin with white piping	1	
7	388703	Hood frame covering kit vinyl, beige with white piping	1	
7	388704	Hood frame covering kit vinyl, tan with white piping	1	
7	312545	Hood frame covering kit vinyl, midnight blue with white piping	1	
7	388706	Hood frame covering kit vinyl, dove grey with white piping	1	
7	379261	Hood frame covering kit vinyl, biscuit with biscuit piping	1	
8	205737	Retaining clip door panel	30	Door pocket retaining
9	209749	Bush securing door panel clip	30	
10	12606	Cup washer with claw	4	
11	3815	Self tapping screw	4	
12	1349	Cap on self tapping screw - black	4	Wheel arch and cockpit panel retaining
13	5341	Cup washer	16	
14	18071	Self tapping screw	16	
15	389	Lift the dot socket fastener	4	Securing hood frame covering kit on rear floor panel
16	390	Lift the dot clinch plate	4	
17	296896	Lift the dot peg	4	
18	18071	Self tapping screw	8	
19	396078	Trim kit black with black piping	1	9 piece leather kit. Soft top models need in addition our hood frame covering kit (ill. 20)
19	330810	Trim kit black with white piping	1	
19	300731	Trim kit black with red piping	1	
19	330811	Trim kit cherokee red with white piping	1	
19	395929	Trim kit matador red with white piping	1	
19	395937	Trim kit doeskin with white piping	1	
19	395997	Trim kit beige with white piping	1	
19	396032	Trim kit tan with white piping	1	
19	396043	Trim kit light tan with light tan piping	1	
19	330814	Trim kit midnight blue with white piping	1	
19	396046	Trim kit dove grey with white piping	1	
19	396055	Trim kit biscuit with biscuit piping	1	

Note:
 Ask for f.o.c. colour samples.
 For details please look at the last page of this catalogue.

20.11

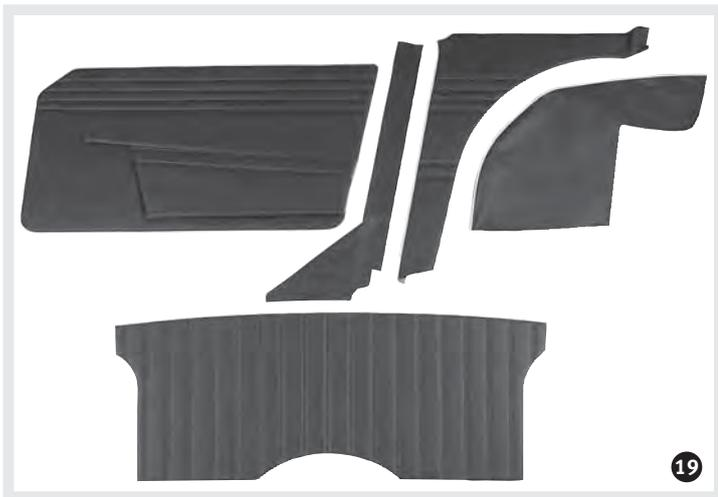
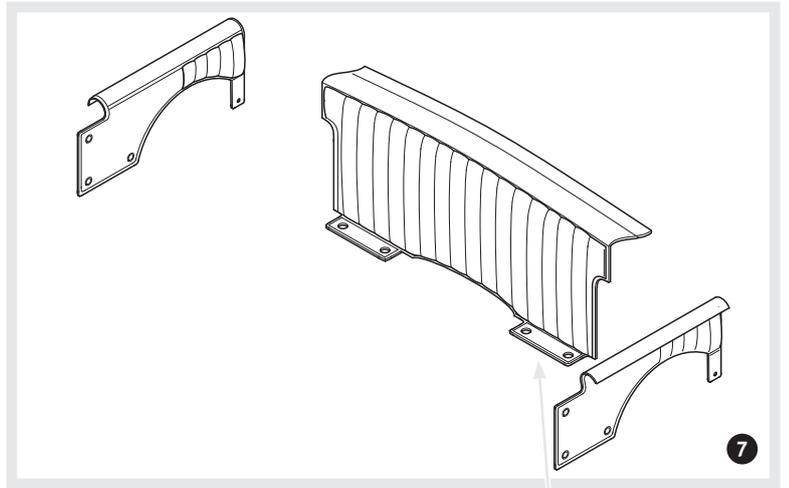
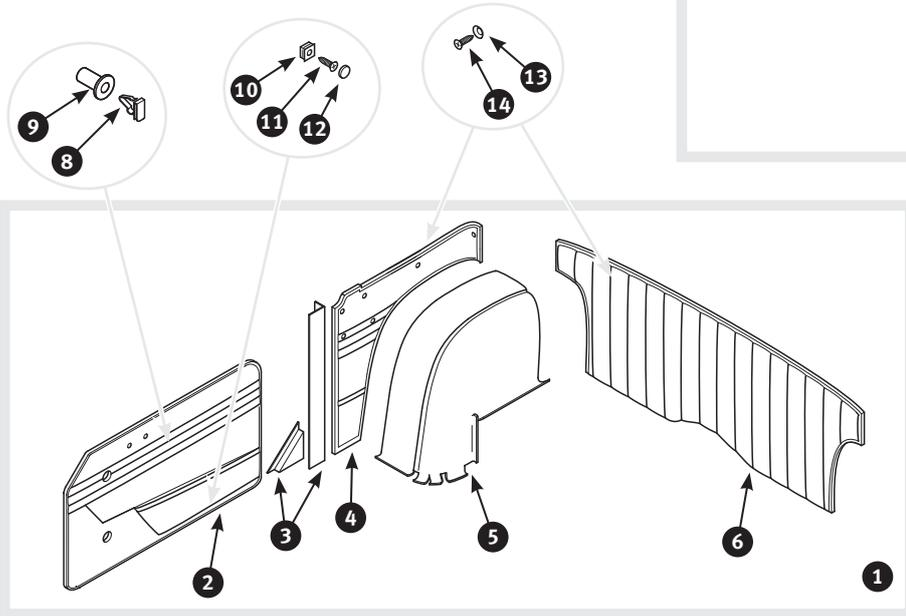

No	Part No	Description	Qty	Notes
20	389127	Hood frame covering kit leather, black with black piping	1	Soft top models only
20	389128	Hood frame covering kit leather, black with white piping	1	
20	389139	Hood frame covering kit leather, black with red piping	1	
20	389138	Hood frame covering kit leather, cherokee red with white piping . . .	1	
20	389145	Hood frame covering kit leather, matador red with white piping . . .	1	
20	389151	Hood frame covering kit leather, doeskin with white piping	1	
20	389152	Hood frame covering kit leather, beige with white piping	1	
20	389224	Hood frame covering kit leather, tan with white piping	1	
20	389246	Hood frame covering kit leather, light tan with light tan piping . . .	1	
20	389248	Hood frame covering kit leather, midnight blue with white piping . .	1	
20	394297	Hood frame covering kit leather, dove grey with white piping	1	
20	294077	Hood frame covering kit leather, biscuit with biscuit piping	1	



Hamper
 for 2 persons, willow made with cord handle, size: 44 x 32 x 22 cm
 Content: two white porcelain plates, two white porcelain cups in a willow bread basket, one 1-litre vacuum flask, 6-piece stainless steel cutlery with plastic handles, one opener and two rectangular shaped containers
 Part no.485742

Note:
 Ask for f.o.c. colour samples.
 For details please look at the last page of this catalogue.

20.12

Seats and interior trim

Trim kits - TR4A

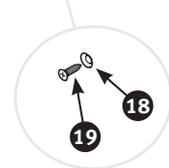
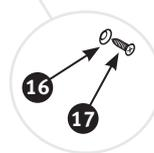
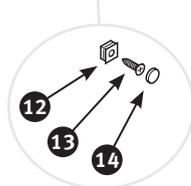
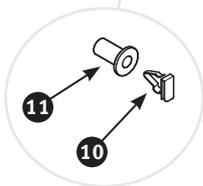
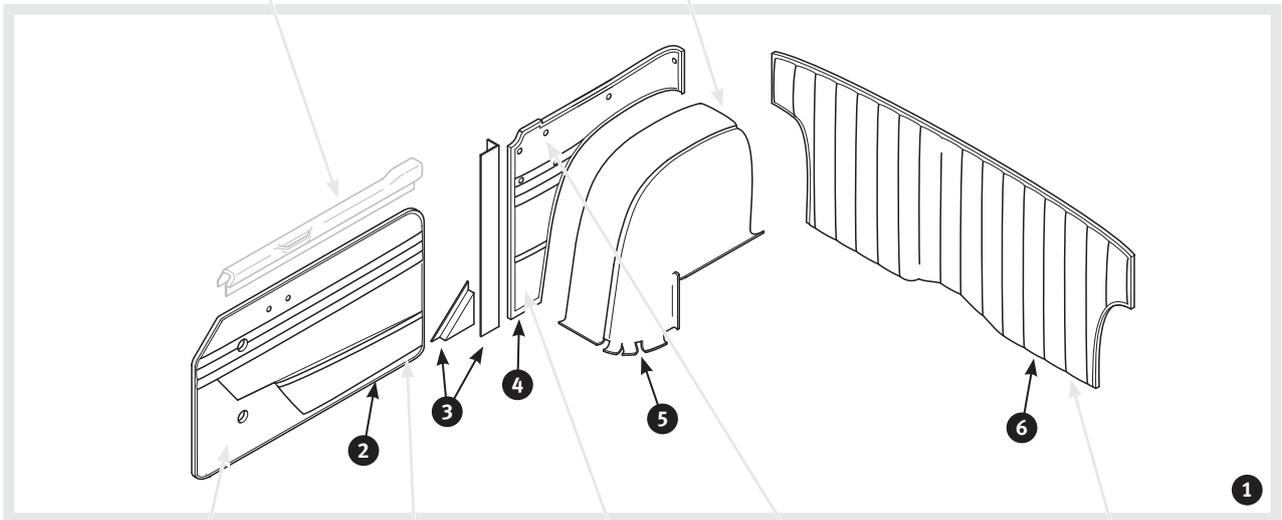
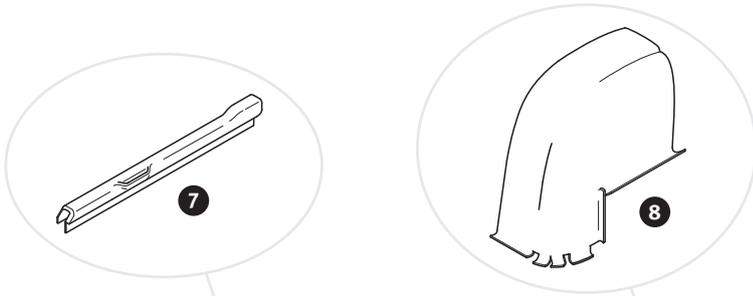

No	Part No	Description	Qty	Notes
1	20241	Trim kit black with white piping	1	9 piece vinyl kit
1	20242	Trim kit cherokee red with white piping	1	
1	312376	Trim kit matador red with white piping	1	
1	396804	Trim kit doeskin with white piping	1	
1	396805	Trim kit beige with white piping	1	
1	396808	Trim kit tan with white piping	1	
1	22902	Trim kit midnight blue with white piping	1	
1	396814	Trim kit dove grey with white piping	1	
1	315191	Trim kit biscuit with biscuit piping	1	
2	328075	Door panels black with white piping	1	2 piece vinyl kit
2	315914	Door panels cherokee red with white piping	1	
2	447056	Door panels matador red with white piping	1	
2	447060	Door panels doeskin with white piping	1	
2	447045	Door panels beige with white piping	1	
2	447048	Door panels tan with white piping	1	
2	330819	Door panels midnight blue with white piping	1	
2	307901	Door panels dove grey with white piping	1	
2	448683	Door panels biscuit with biscuit piping	1	
3	307825	Vinyl material ,B' post, black	1	4 piece kit
3	2226	Vinyl material ,B' post, cherokee red	1	
3	307828	Vinyl material ,B' post, matador red	1	
3	204205	Vinyl material ,B' post, doeskin	1	
3	330182	Vinyl material ,B' post, beige	1	
3	330181	Vinyl material ,B' post, tan	1	
3	330603	Vinyl material ,B' post, midnight blue	1	
3	22897	Vinyl material ,B' post, dove grey	1	
3	301941	Vinyl material ,B' post, biscuit with biscuit piping	1	
4	330831	Rear wheel arch panels black with white piping	1	2 piece vinyl kit
4	330832	Rear wheel arch panels cherokee red with white piping	1	
4	458719	Rear wheel arch panels matador red with white piping	1	
4	449169	Rear wheel arch panels doeskin with white piping	1	
4	449751	Rear wheel arch panels beige with white piping	1	
4	451947	Rear wheel arch panels tan with white piping	1	
4	330835	Rear wheel arch panels midnight blue with white piping	1	
4	458843	Rear wheel arch panels dove grey with white piping	1	
4	459457	Rear wheel arch panels biscuit with biscuit piping	1	
5	328916	Vinyl material rear wheel arch, black with white piping	1	2 piece kit
5	330844	Vinyl material rear wheel arch, cherokee red with white piping	1	
5	330843	Vinyl material rear wheel arch, matador red with white piping	1	
5	459685	Vinyl material rear wheel arch, doeskin with white piping	1	
5	459686	Vinyl material rear wheel arch, beige with white piping	1	
5	459716	Vinyl material rear wheel arch, tan with white piping	1	
5	330847	Vinyl material rear wheel arch, midnight blue with white piping	1	
5	446940	Vinyl material rear wheel arch, dove grey with white piping	1	
5	446949	Vinyl material rear wheel arch, biscuit with biscuit piping	1	

Note:
 Ask for f.o.c. colour samples.
 For details please look at the last page of this catalogue.

20.12

Seats and interior trim

Trim kits - TR4A

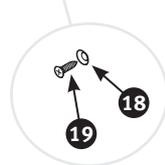
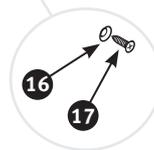
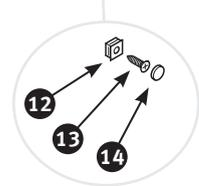
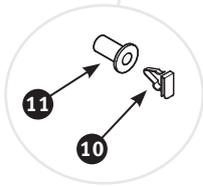
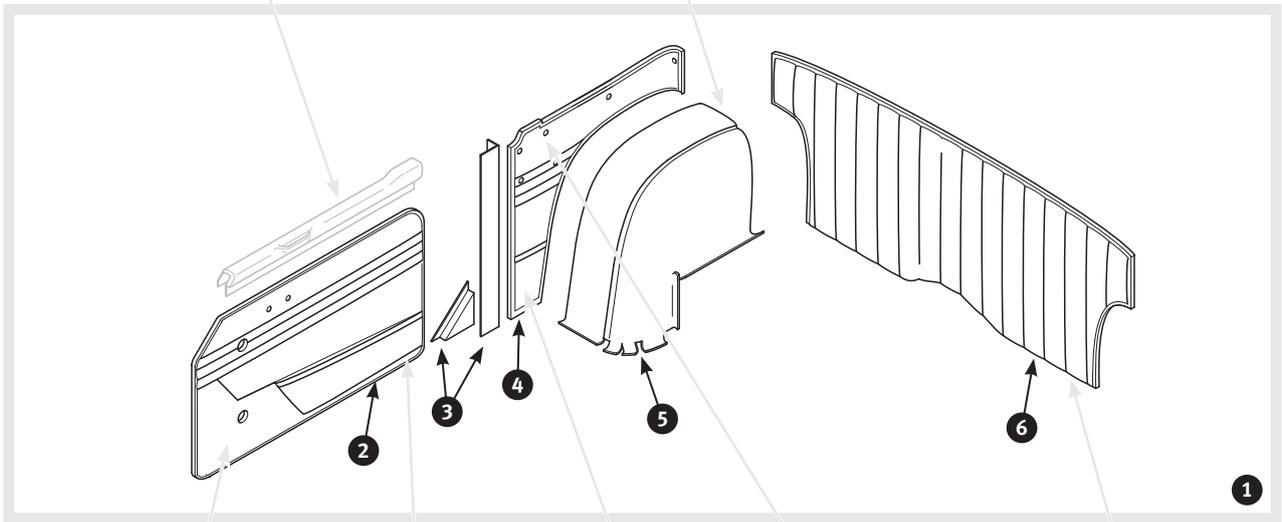
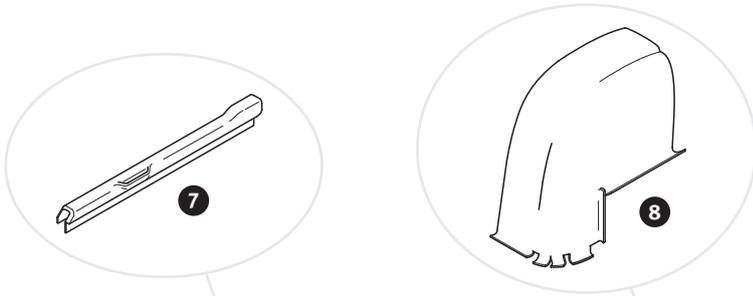

No	Part No	Description	Qty	Notes
6	484	Cockpit panel black	1	Vinyl
6	331154	Cockpit panel cherokee red	1	
6	396873	Cockpit panel matador red	1	
6	423459	Cockpit panel doeskin	1	
6	423467	Cockpit panel beige	1	
6	423643	Cockpit panel tan	1	
6	331157	Cockpit panel midnight blue	1	
6	424510	Cockpit panel dove grey	1	
6	434268	Cockpit panel biscuit	1	
7	4744	Capping LH door - plastic	1	
7	4745	Capping RH door - plastic	1	
8	15231	Foam pad rear wheel arch panel	2	
9	336400	Fitting kit trim panels	1	
10	205737	Retaining clip door panel	30	
11	209749	Bush securing door panel clip	30	
12	12606	Cup washer with claw	4	Door pocket retaining
13	3815	Self tapping screw	4	
14	1349	Cap on self tapping screw - black	4	
15	205737	Retaining clip	6	Rear wheel arch panel retaining
16	5341	Cup washer	6	
17	18071	Self tapping screw	6	
18	5341	Cup washer	11	Cockpit panel retaining
19	18071	Self tapping screw	11	
20	436549	Trim kit black with black piping	1	9 piece leather kit
20	315359	Trim kit black with white piping	1	
20	436731	Trim kit black with red piping	1	
20	331142	Trim kit cherokee red with white piping	1	
20	436759	Trim kit matador red with white piping	1	
20	436783	Trim kit doeskin with white piping	1	
20	436824	Trim kit beige with white piping	1	
20	436826	Trim kit tan with white piping	1	
20	436844	Trim kit light tan with tan piping	1	
20	331325	Trim kit midnight blue with white piping	1	
20	436863	Trim kit dove grey with white piping	1	
20	341957	Trim kit biscuit with biscuit piping	1	
21	487057	Svissvax Leather care kit with German label	1	Content: 250 ml leather cleaner, 250 ml leather milk, 25 ml elephant dubbin, leather brush, care towel and applicator
21	329976	Svissvax Leather care kit with English label	1	



Knipex Revolving punch pliers
with 6 punch tubes from 2 to 5 mm. For
punching clean holes in leather, vinyl and
other fabrics. Powder coated
Part no. 467345

Note:
Ask for f.o.c. colour samples.
For details please look at the last page of this catalogue.

20.13

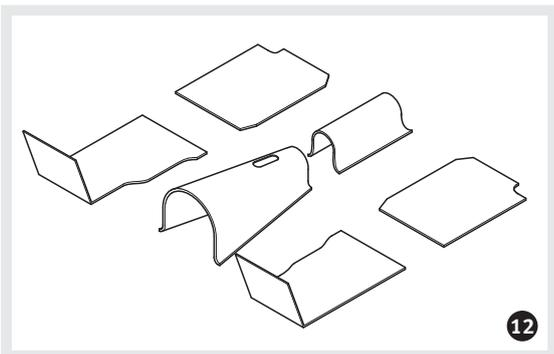
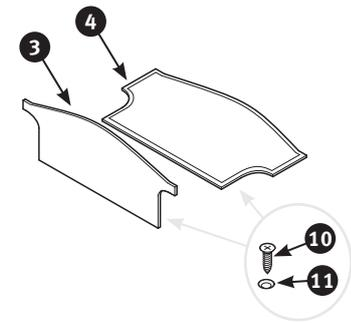
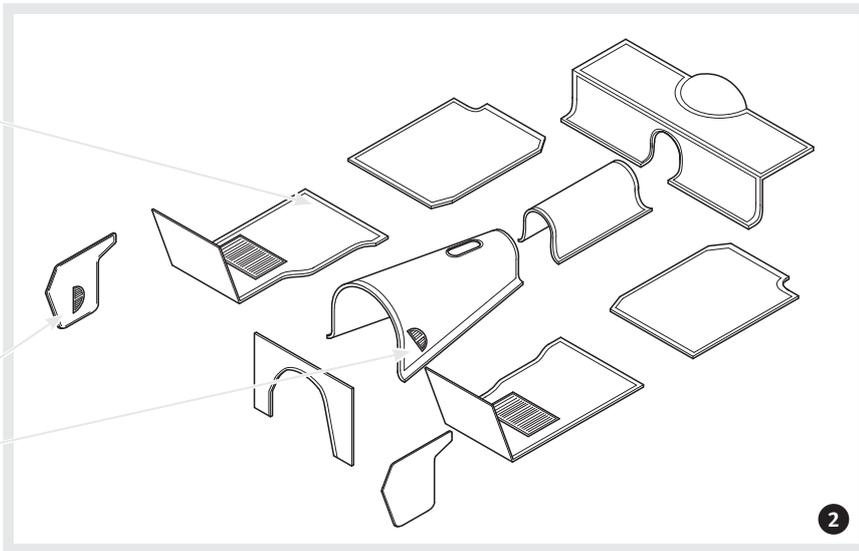
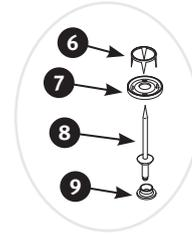
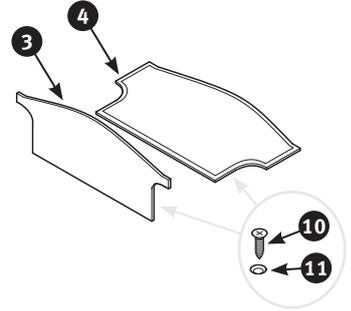
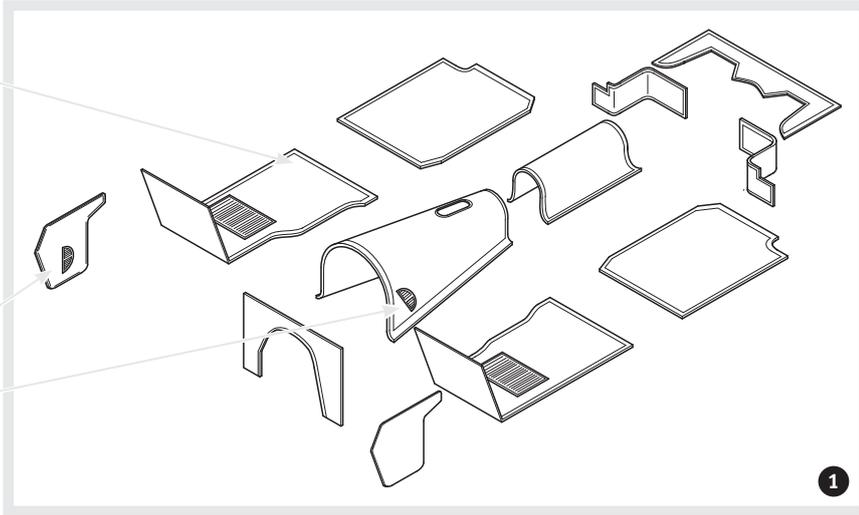
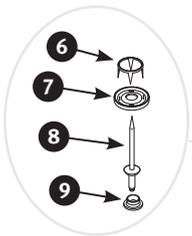

No	Part No	Description	Qty	Notes
1	13968	Carpet set black	1	TR2 and TR3, TR3A to TS60000 - de-luxe pile
1	13969	Carpet set red	1	
1	17688	Carpet set navy	1	
1	13977	Carpet set black	1	TR2 and TR3, TR3A to TS60000 - 100% wool
1	13978	Carpet set red	1	
1	13980	Carpet set navy	1	
2	13971	Carpet set black	1	
2	13972	Carpet set red	1	TR3A from TS60001, TR3B - de-luxe pile
2	330656	Carpet set navy	1	
2	13982	Carpet set black	1	TR3A from TS60001, TR3B - 100% wool
2	13983	Carpet set red	1	
2	13985	Carpet set navy	1	
3	21240	Board fuel tank - in boot area	1	
4	330177	Boot carpet black - de-luxe pile	1	TR2 and TR3
4	3174	Boot carpet black - 100% wool	1	
4	3801	Boot mat black - hadura	1	TR3A and TR3B
5	1849	Rubber mat for carpet protection	4	
6	8500	Carpet spike	0	Quantity as required
7	4579	Female carpet clip	0	
8	10085	Pop rivet	0	
9	203055	Durable dot fastener - riveted to floor panel	0	
10	11049	Self tapping screw tank board and boot mat attachment	14	
11	12587	Cup washer	14	
12	330246	Sound deadening kit	1	TR2 and TR3, TR3A to TS60000
12	330247	Sound deadening kit	1	
13	20056	Adhesive for carpets - 400 ml aerosol	0	TR3A from TS60001, TR3B
13	16109	Adhesive for carpets - 750 ml can	0	
14	4525	Rubber mats footwell, black with 'Triumph' script - supplied in pairs	1	Quantity as required

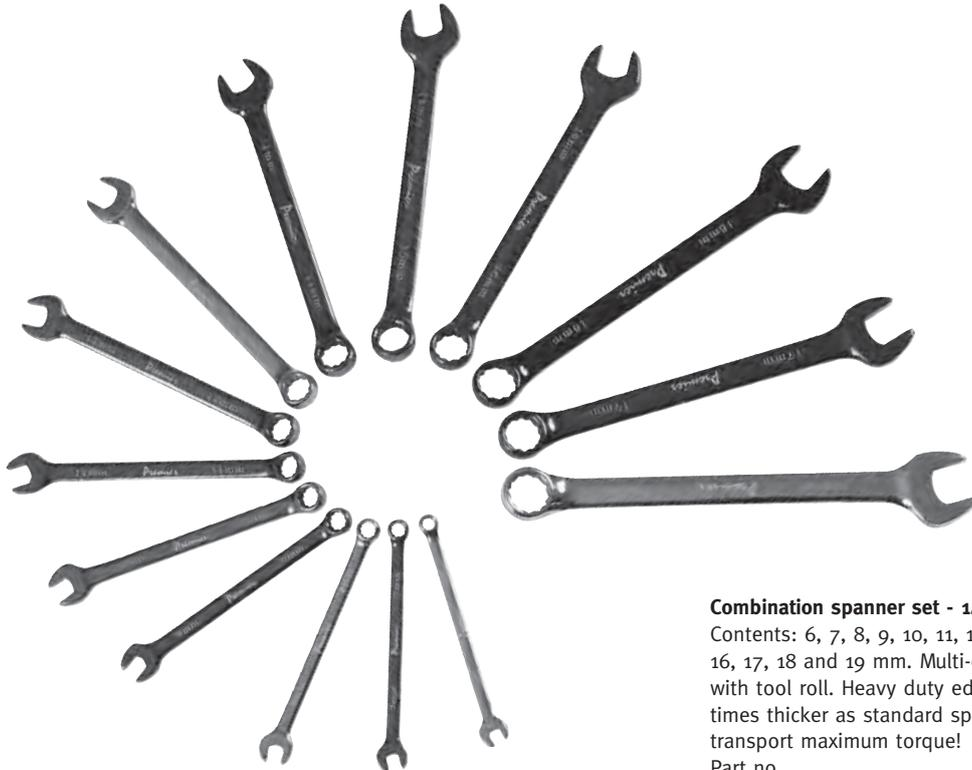

Combination spanner set - 14 piece
 Contents: 6, 7, 8, 9, 10, 11, 12, 13, 14, 15, 16, 17, 18 and 19 mm. Multi-color. Comes with tool roll. Heavy duty edition, ca. 1,5 times thicker as standard spanners to transport maximum torque!
 Part no. 464592

Note:
 Ask for f.o.c. colour samples.
 For details please look at the last page of this catalogue.

20.14

Seats and interior trim Carpet sets - TR4 and TR4A

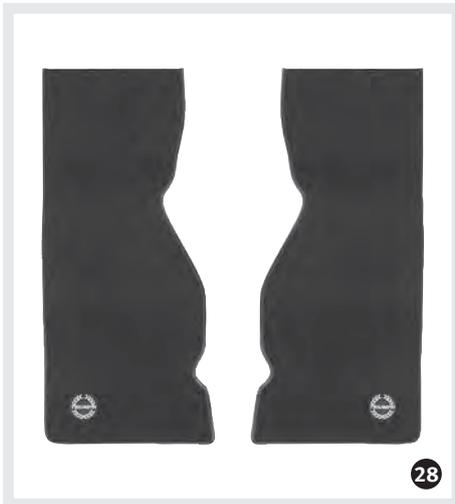
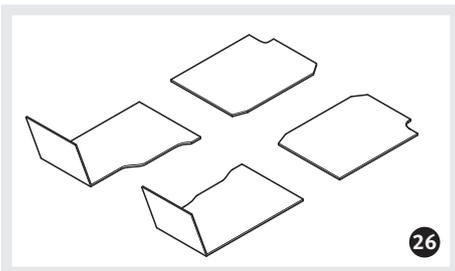
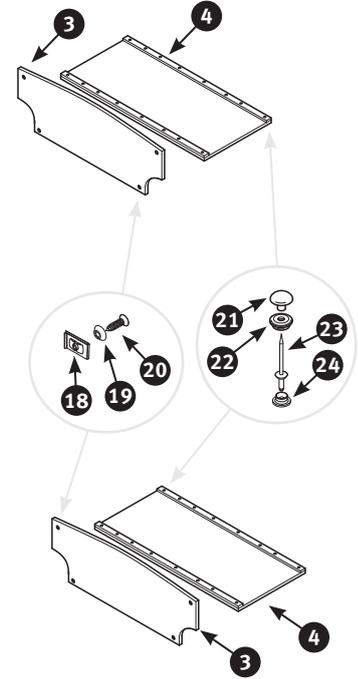
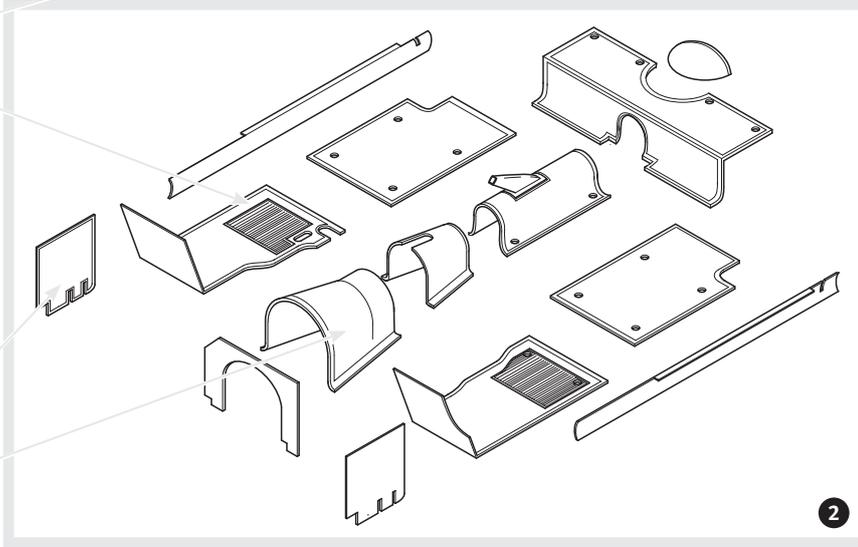
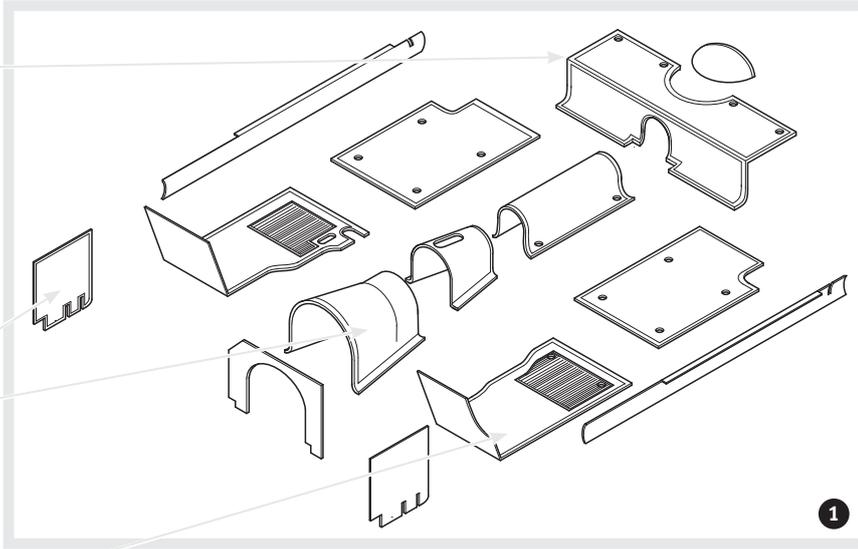
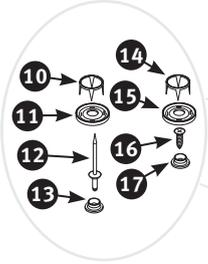
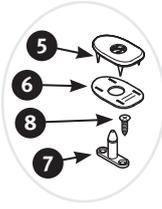

No	Part No	Description	Qty	Notes	
1	13974	Carpet set black	1	TR4 - de-luxe pile	
1	13975	Carpet set cherokee red	1		
1	396080	Carpet set tan	1		
1	331023	Carpet set navy	1		
1	331025	Carpet set wedgewood blue	1		
1	396090	Carpet set dove grey	1		
1	396117	Carpet set biscuit	1	TR4 - 100% wool	
1	13987	Carpet set black	1		
1	13988	Carpet set cherokee red	1		
1	13989	Carpet set tan	1		
1	331012	Carpet set navy	1		
1	331006	Carpet set wedgewood blue	1		
1	13991	Carpet set dove grey	1	TR4A - de-luxe pile	
1	396670	Carpet set biscuit	1		
2	13753	Carpet set black	1		
2	13755	Carpet set cherokee red	1		
2	13757	Carpet set tan	1		
2	339014	Carpet set navy	1		
2	15213	Carpet set wedgewood blue	1	TR4A - 100% wool	
2	13967	Carpet set dove grey	1		
2	396769	Carpet set biscuit	1		
2	13754	Carpet set black	1		
2	13756	Carpet set cherokee red	1		
2	468734	Carpet set tan	1		
2	331257	Carpet set navy	1	TR4A - 100% wool	
2	13759	Carpet set wedgewood blue	1		
2	13992	Carpet set dove grey	1		
2	396666	Carpet set biscuit	1		
3	144	Board fuel tank - in boot area	1		Rear seat pan to carpet - TR4
4	289414	Cover spare wheel	1		
5	389	Lift the dot socket fastener	4		
6	390	Lift the dot clinch plate	4		
7	296896	Lift the dot peg	4		
8	5760	Self tapping screw	8		
9	1849	Rubber mat for carpet protection	4	When sound deadening kit is not fitted - Quantity as required	
10	8500	Carpet spike	0		
11	4579	Female carpet clip	0		
12	10085	Pop rivet	0		
13	203055	Durable dot fastener - riveted to floor panel	0		
14	8500	Carpet spike	0		
15	4579	Female carpet clip	0	When sound deadening kit is fitted - Quantity as required	
16	3814	Self tapping screw	0		
17	5585	Socket carpet retaining - screwed to floor panel	0		

Order free of charge:

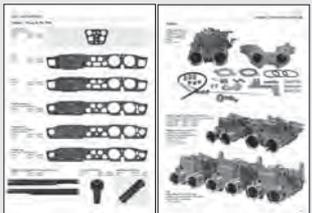

Tuning catalogue

Order free of charge:

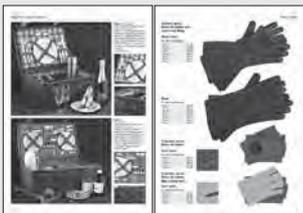

Accessories catalogue

Note:
 Ask for f.o.c. colour samples.
 For details please look at the last page of this catalogue.

20.14

Seats and interior trim Carpet sets - TR4 and TR4A

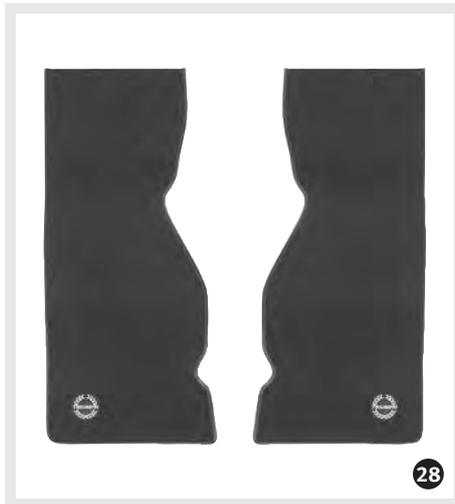
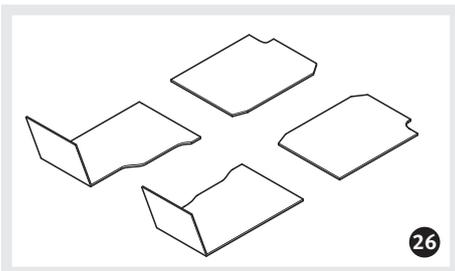
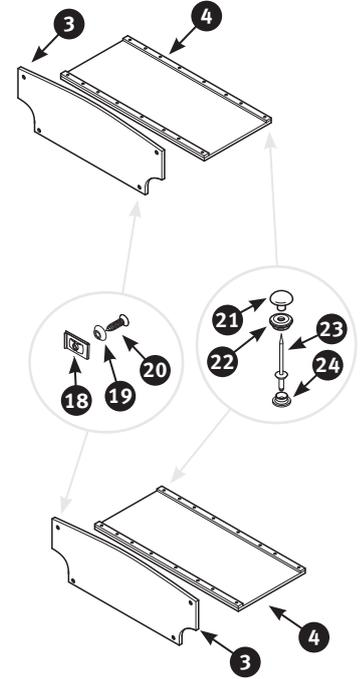
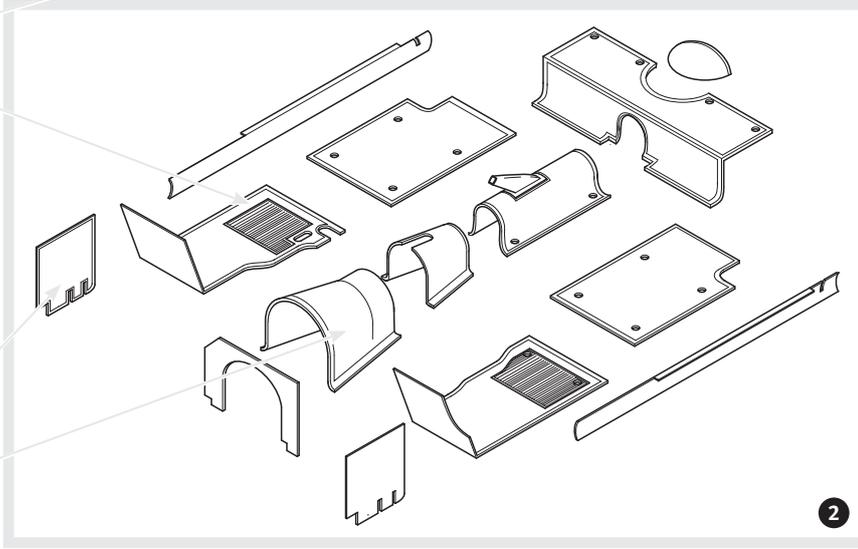
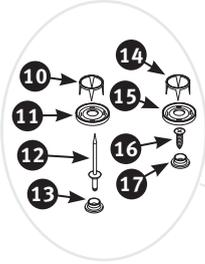
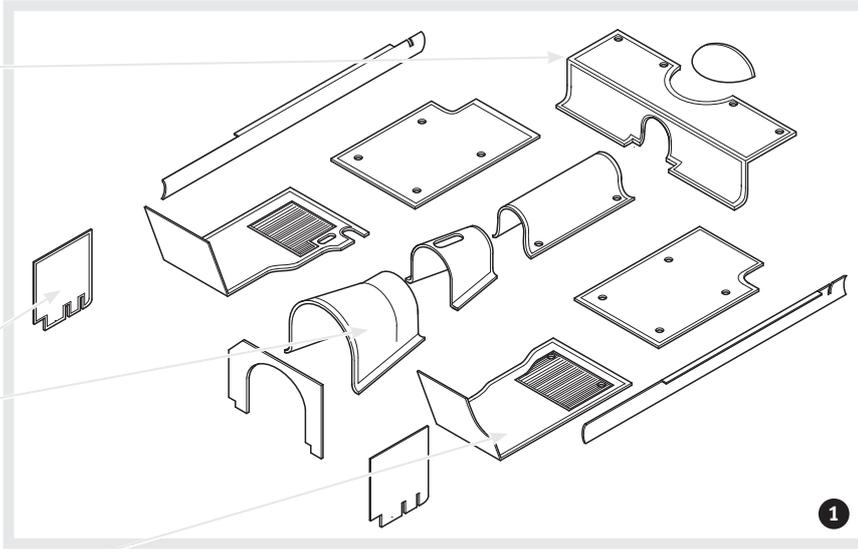
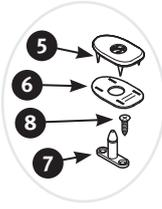

20.14

No	Part No	Description	Qty	Notes
18	3824	Spire nut	8	} Tank board retaining
19	11166	Plain washer	8	
20	3821	Self tapping screw	8	
21	9306	Durable dot socket	2	} Spare wheel cover retaining
22	9307	Durable dot base	2	
23	4870	Pop rivet	2	
24	203055	Durable dot fastener	2	
25	309516	Fitting kit carpet set.	1	
26	316598	Sound deadening kit	1	} TR4
26	14306	Sound deadening kit	1	
27	1873	Boot carpet black - de-luxe pile	1	} Optional extra
28	15399	Footwell carpets black with ,Triumph' script - de-luxe pile	1	} Supplied in pairs
28	16552	Footwell carpets black without ,Triumph' script - 100% wool	1	
29	4525	Rubber mats footwell, black with ,Triumph' script.	1	

Adhesive

for carpets, seat covers and trim panels

400 ml aerosol

Part no. 20056

750 ml can

Part no. 16109



Note:
 Ask for f.o.c. colour samples.
 For details please look at the last page of this catalogue.

20.15

Seats and interior trim

Hood, tonneau and hood cover - TR2 to TS5255

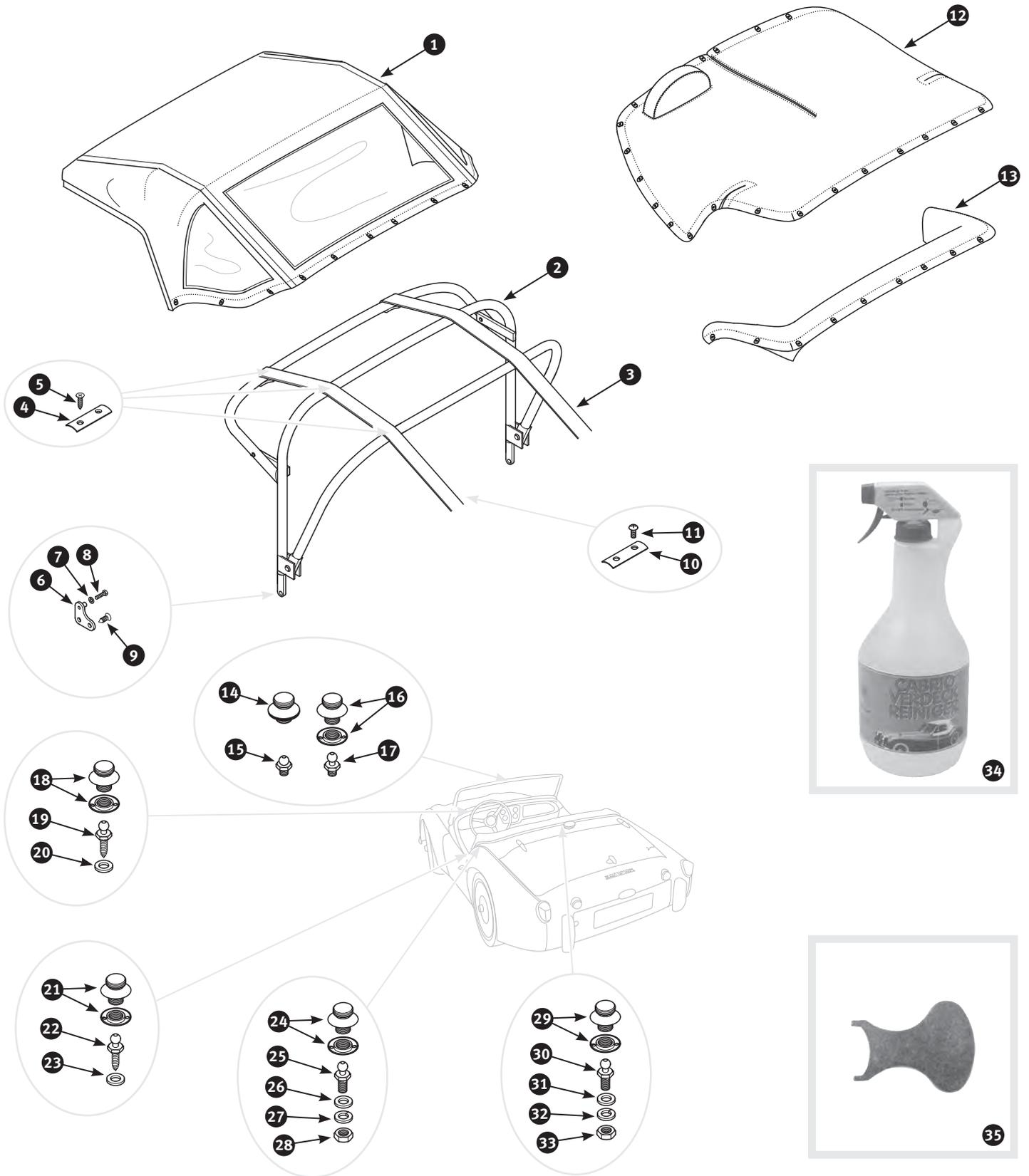

No	Part No	Description	Qty	Notes
1	17137	Vinyl hood black - heavy duty material	1	} Variant with 3 windows
1	373278	Vinyl hood black - everflex material.	1	
1	317258	Canvas hood black - double duck material.	1	
1	317257	Mohair hood black.	1	
2	325503	Hood frame	1	} Secures webbings to hood frame sticks
3	16494	Webbing hood - in black	2	
4	1825	Clamping plate	6	
5	19296	Self tapping screw	12	
6	11283	Clamp plate hood frame to body - LH	1	
6	11284	Clamp plate hood frame to body - RH	1	
7	212195	Plain washer	2	} Secures webbings to rear decking panel
8	11264	Screw hood frame to clamp plate	2	
9	20959	Countersunk screw clamp plate to body	4	
10	1825	Clamping plate	2	
11	214337	Panhead screw	2	
12	11437	Vinyl tonneau black - heavy duty material	1	
12	373632	Vinyl tonneau black - everflex material	1	
12	317256	Canvas tonneau black - double duck material	1	
12	327505	Mohair tonneau black	1	} RHD cars
12	11436	Vinyl tonneau black - heavy duty material	1	
12	330119	Vinyl tonneau black - everflex material	1	
12	323334	Canvas tonneau black - double duck material	1	
12	372342	Mohair tonneau black	1	
13	2476	Vinyl hood cover black - heavy duty material	1	
13	373780	Vinyl hood cover black - everflex material	1	
13	315282	Canvas hood cover black - double duck material	1	
13	327506	Mohair hood cover black	1	
14	479300	Tenax fastener	10	} Hood to windscreen frame (original style). If not available use TR3 Tenax fittings as a set (ill. 16 and 17)
15	290287	Tenax peg	10	
16	8015	Tenax fastener with base	10	} Hood to windscreen frame (TR3 style)
17	393	Tenax peg	10	
18	8015	Tenax fastener with base	30	} Tonneau to door and scuttle panel
19	21292	Tenax peg - self tapping.	16	
20	5458	Leather washer	16	} Hood and tonneau to ,B' post
21	8015	Tenax fastener with base	2	
22	21291	Tenax peg - self tapping.	2	
23	5458	Leather washer	2	
24	8015	Tenax fastener with base	2	} Hood cover to capping behind ,B' post
25	1224	Tenax peg	2	
26	5458	Leather washer	2	
27	212190	Spring washer	2	
28	215477	Nut	2	
29	8015	Tenax fastener with base	12	
30	1224	Tenax peg	12	} Hood, tonneau and hood cover to rear decking panel
31	5458	Leather washer	12	
32	212190	Spring washer	12	
33	215477	Nut	12	
34	205401	Fertan Hood cleaner for vinyl hoods, 1 litre pump spray	1	
35	20709	Tool - special key for tenax fasteners	1	

Note: Hood materials and specifications:

A: **Heavy duty vinyl** - a popular grade material specifically formulated to reproduce the texture and appearance of the vinyl hoods on most British sports cars. The typical life expectancy for this material is over 5 years. Available in black only. B: **Everflex Vinyl** - used as Original Equipment by most British sports car Manufacturers. Our Everflex hoods and tonneaus are considered to be the best choice for those seeking to retain that „original factory appearance“. The typical life expectancy for this material is over 10 years. Various colours available. C: **Double duck** - a 20 oz canvas hooding fitted as standard to many classic cars. This material is popular as a direct replacement to a vinyl hood, offering improved insulation properties in comparison to vinyl hoods. Available in black only. D: **Mohair** - a superior quality canvas material considered to be the finest car hooding material available and used as original equipment by many of the worlds luxury car manufacturers. We have seen 20 plus years old examples of hoods made from this fabric that still look as good as new. Mohair does not require any special treatments and is available in various colours.

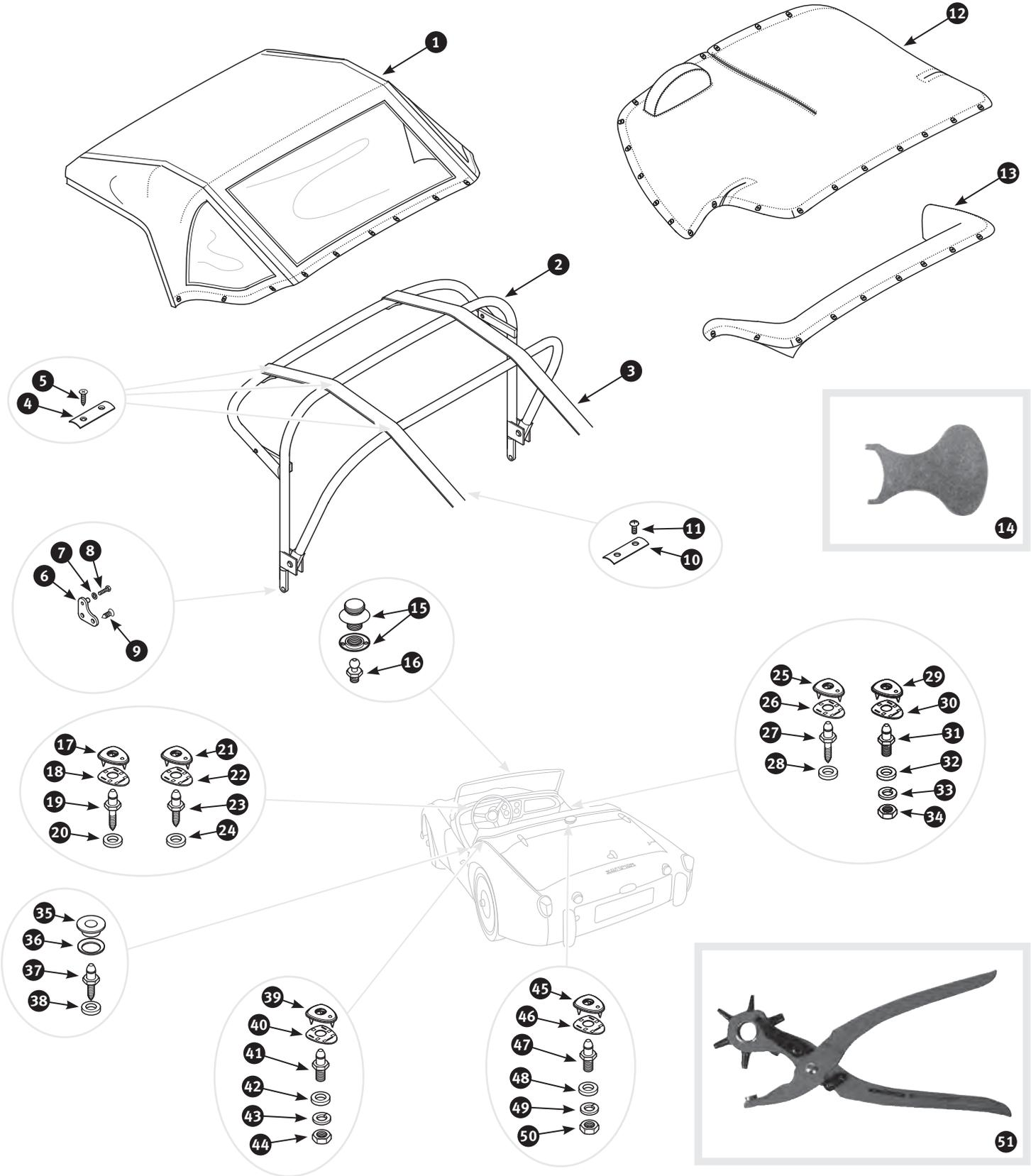

No	Part No	Description	Qty	Notes
1	17137	Vinyl hood black - heavy duty material	1	} Variant with 3 windows
1	373278	Vinyl hood black - everflex material.	1	
1	317258	Canvas hood black - double duck material.	1	
1	317257	Mohair hood black.	1	
2	325503	Hood frame	1	} Secures webbings to hood frame sticks
3	16494	Webbing hood - in black	2	
4	1825	Clamping plate	6	
5	19296	Self tapping screw	12	
6	11283	Clamp plate hood frame to body - LH	1	
1	11284	Clamp plate hood frame to body - RH	1	
7	212195	Plain washer	2	} Secures webbings to tonneau decking panel
8	11264	Screw hood frame to clamp plate	2	
9	20959	Countersunk screw clamp plate to body	4	
10	1825	Clamping plate	2	
11	214337	Panhead screw	2	
12	11437	Vinyl tonneau black - heavy duty material	1	
12	373632	Vinyl tonneau black - everflex material	1	
12	317256	Canvas tonneau black - double duck material	1	
12	327505	Mohair tonneau black	1	} RHD cars
12	11436	Vinyl tonneau black - heavy duty material	1	
12	330119	Vinyl tonneau black - everflex material	1	
12	323334	Canvas tonneau black - double duck material	1	
12	372342	Mohair tonneau black	1	
13	2476	Vinyl hood cover black - heavy duty material	1	
13	373780	Vinyl hood cover black - everflex material	1	
13	315282	Canvas hood cover black - double duck material	1	
13	327506	Mohair hood cover black	1	
14	20709	Tool - special key for tenax fasteners.	1	
15	8015	Tenax fastener with base	10	} Hood to windscreen frame
16	393	Tenax peg	10	
17	389	Lift the dot socket fastener	8	} TR2 and TR3, TR3A to TS60000. Tonneau to scuttle panel
18	390	Lift the dot clinch plate	8	
19	11416	Lift the dot peg - self tapping.	8	
20	5458	Leather washer	8	
21	389	Lift the dot socket fastener	8	} TR3A from TS60001, TR3B. Tonneau to scuttle panel
22	390	Lift the dot clinch plate	8	
23	11415	Lift the dot peg - self tapping.	8	} TR2 and TR3, TR3A to TS60000. Tonneau to door
24	5458	Leather washer	8	
25	389	Lift the dot socket fastener	8	
26	390	Lift the dot clinch plate	8	
27	11416	Lift the dot peg - self tapping.	8	} TR3A from TS60001, TR3B. Tonneau to door
28	5458	Leather washer	8	
29	389	Lift the dot socket fastener	8	
30	390	Lift the dot clinch plate	8	
31	19738	Lift the dot peg	8	} TR3A from TS60001, TR3B. Tonneau to door
32	5458	Leather washer	8	
33	212190	Spring washer	8	} Hood and tonneau to ,B' post
34	215477	Nut	8	
35	10371	Eyelet	2	
36	10372	Retaining ring for eyelet.	2	
37	11415	Lift the dot peg - self tapping.	2	
38	5458	Leather washer	2	

Note:
 Ask for f.o.c. colour samples.
 For details please look at the last page of this catalogue.

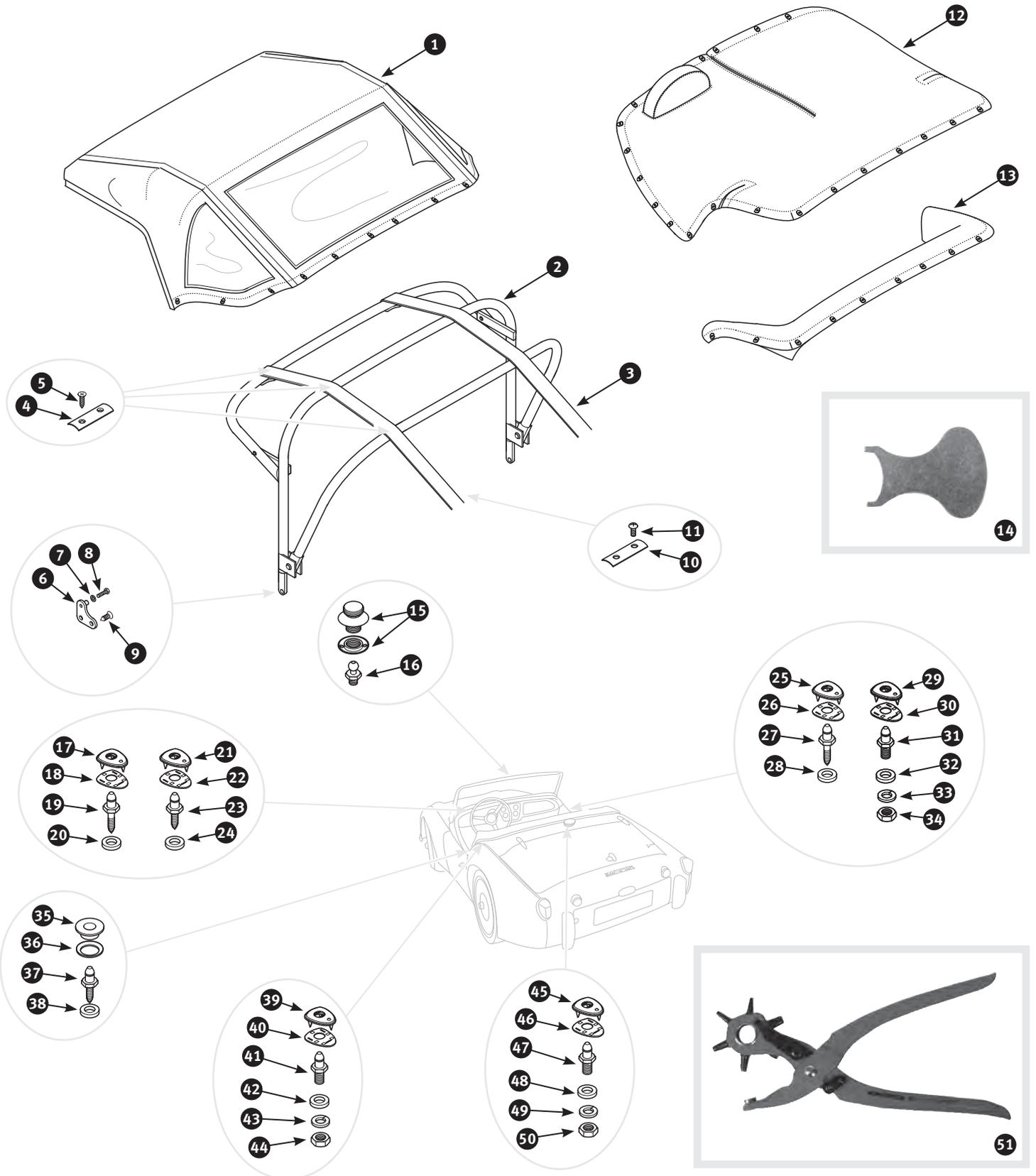

No	Part No	Description	Qty	Notes
39	389	Lift the dot socket fastener	12	Hood cover to capping behind ,B' post
40	390	Lift the dot clinch plate	2	
41	19738	Lift the dot peg	2	
42	5458	Leather washer	2	
43	212190	Spring washer	2	
44	215477	Nut	2	Hood, tonneau and hood cover to rear decking panel
45	389	Lift the dot socket fastener	12	
46	390	Lift the dot clinch plate	12	
47	19738	Lift the dot peg	12	
48	5458	Leather washer	12	
49	212190	Spring washer	12	
50	215477	Nut	12	
51	467345	Knipex Revolving punch pliers with 6 punch tubes from 2 to 5 mm. For punching clean holes in leather, vinyl and other fabrics. Powder coated	1	



Autoglym Car Interior Shampoo

A carefully balanced blend of surface active ingredients and deodorising agents „deep clean“ quickly and safely. This easy to use spray and wipe formula removes stains and grime from synthetic fabric upholstery, carpets, roof linings, vinyls, leather and plastics. Ideal for use as a general cleaner in caravans, boats, trucks and many other situations. 500 ml.

Part no. 310440

Order free of charge:

Tuning catalogue

Order free of charge:

Accessories catalogue

Note:
Ask for f.o.c. colour samples.
For details please look at the last page of this catalogue.

20.17

Seats and interior trim

Hood and tonneau - TR4

Soft top models only

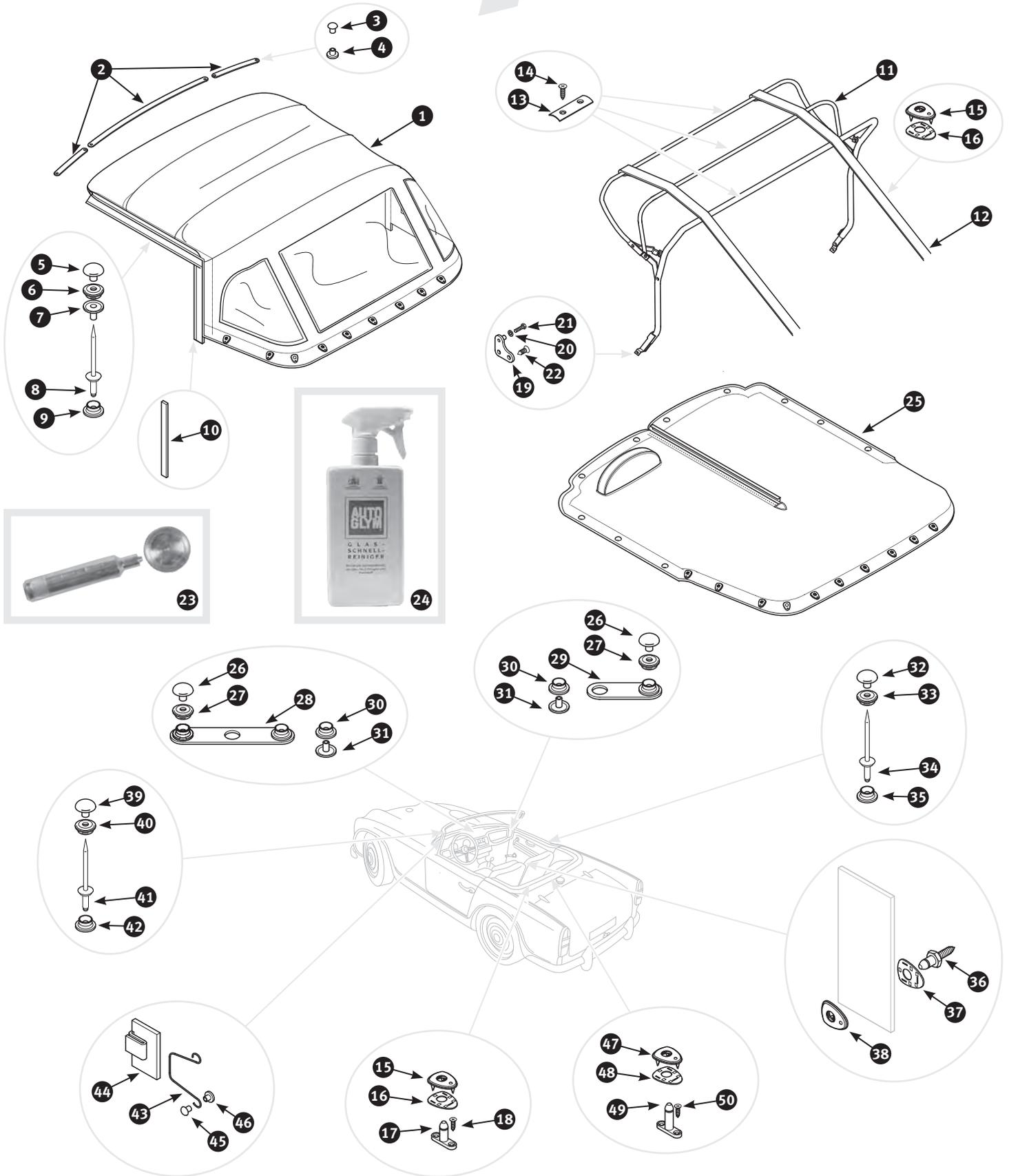

No	Part No	Description	Qty	Notes
1	14713	Vinyl hood black - heavy duty material	1	
1	373547	Vinyl hood black - everflex material.	1	
1	215181	Canvas hood black - double duck material.	1	
1	327433	Mohair hood black.	1	
2	18688	Hood stiffener 3 piece	1	
3	19256	Rivet retaining hood stiffener	12	
4	19308	Cap for rivet	12	
5	4221	Durable dot button on hood - chromed	6	} Lateral hood fixing on hood frame
6	9306	Durable dot socket on hood - chromed	6	
7	9307	Durable dot base on hood - chromed	6	
8	10085	Pop rivet	6	
9	203055	Durable dot fastener on hood frame - chromed	6	
10	19934	Hood stiffener - side	2	
11	21440	Hood frame	1	
12	16494	Webbing hood - in black	2	
13	1825	Clamping plate	6	} Secures webbings to hood frame sticks
14	19296	Self tapping screw	12	
15	389	Lift the dot socket fastener	2	} Secures webbings to tonneau decking panel
16	390	Lift the dot clinch plate	2	
17	296896	Lift the dot peg - height: 5/8".	2	
18	18071	Self tapping screw	4	
19	11283	Clamp plate hood frame to body - LH	1	
19	11284	Clamp plate hood frame to body - RH	1	
20	212195	Plain washer	4	
21	11264	Screw hood frame to clamp plate	2	
22	20959	Countersunk screw clamp plate to body	4	
23	17381	Tool for Durable Dot buttons	1	
24	220603	Autoglym Screen wash 500 ml pumpspray	1	} Recommended for use on acrylic, perspex and plastic windows
25	336736	Vinyl tonneau black - heavy duty material	1	} LHD cars
25	373714	Vinyl tonneau black - everflex material	1	
25	370043	Canvas tonneau black - double duck material	1	
25	373243	Mohair tonneau black	1	
25	347862	Vinyl tonneau black - heavy duty material	1	} RHD cars
25	293890	Vinyl tonneau black - everflex material	1	
25	338326	Canvas tonneau black - double duck material	1	
25	482966	Mohair tonneau black	1	

Note:
 Ask for f.o.c. colour samples.
 For details please look at the last page of this catalogue.

Note: Hood materials and specifications:
 A: **Heavy duty vinyl** - a popular grade material specifically formulated to reproduce the texture and appearance of the vinyl hoods on most British sports cars. The typical life expectancy for this material is over 5 years. Available in black only. B: **Everflex Vinyl** - used as Original Equipment by most British sports car Manufacturers. Our Everflex hoods and tonneaus are considered to be the best choice for those seeking to retain that „original factory appearance“. The typical life expectancy for this material is over 10 years. Various colours available. C: **Double duck** - a 20 oz canvas hooding fitted as standard to many classic cars. This material is popular as a direct replacement to a vinyl hood, offering improved insulation properties in comparison to vinyl hoods. Available in black only. D: **Mohair** - a superior quality canvas material considered to be the finest car hooding material available and used as original equipment by many of the worlds luxury car manufacturers. We have seen 20 plus years old examples of hoods made from this fabric that still look as good as new. Mohair does not require any special treatments and is available in various colours.

20.17

Seats and interior trim

Hood and tonneau - TR4

Soft top models only

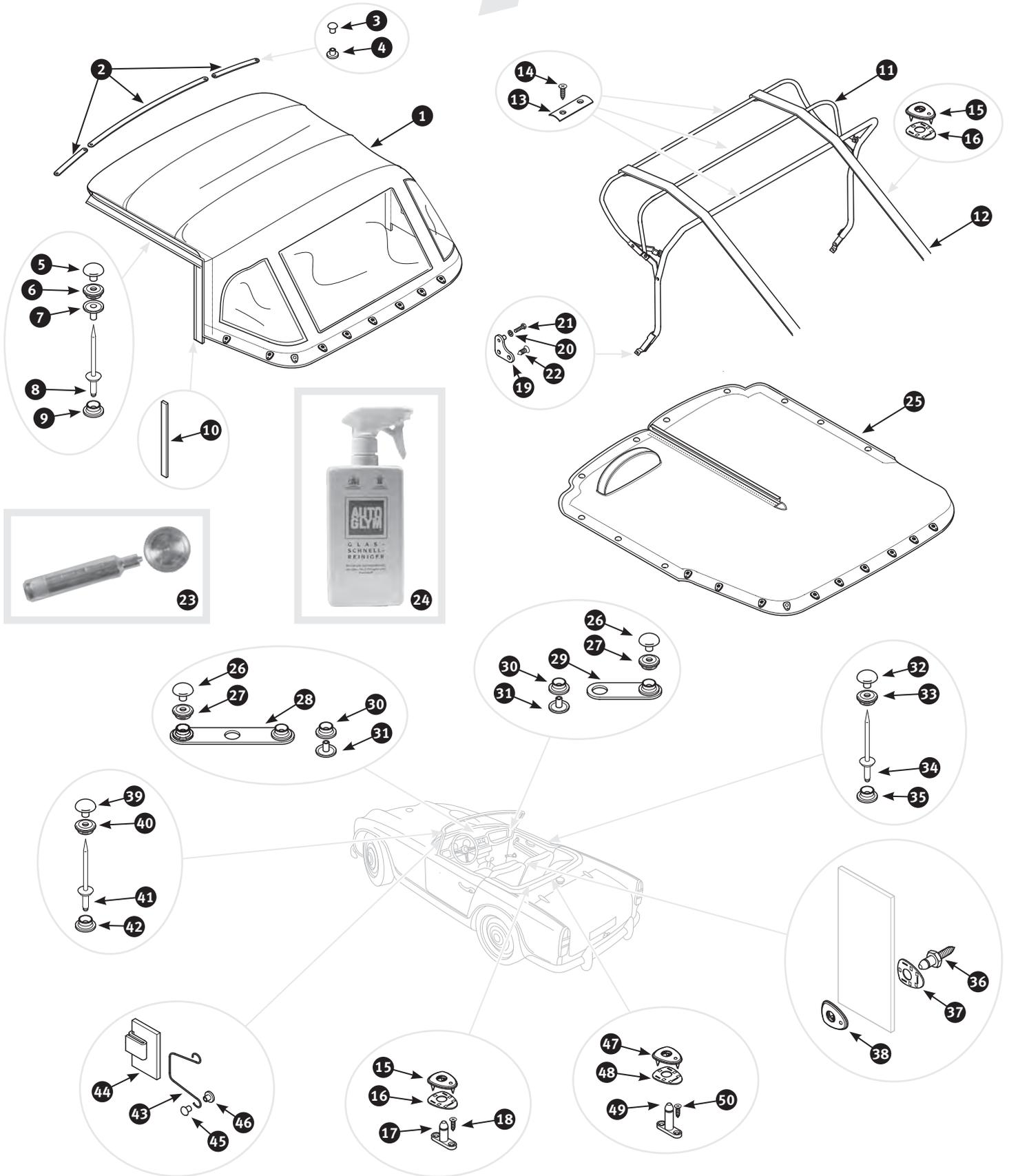

No	Part No	Description	Qty	Notes
26	4221	Durable dot button on tonneau - chromed	4	} Tonneau to scuttle panel
27	9306	Durable dot socket on tonneau - chromed	4	
28	3740	Bracket - centre	1	
29	3741	Bracket - outer	2	
30	203055	Durable dot fastener - separately	4	
31	9307	Durable dot base - separately	4	} Tonneau to door
32	4221	Durable dot button on tonneau - chromed	6	
33	9306	Durable dot socket on tonneau - chromed	6	
34	4870	Pop rivet	6	
35	203055	Durable dot fastener on door - chromed	6	
36	11415	Lift the dot peg on passenger seat	1	
37	390	Lift the dot clinch plate on tonneau tie strip	1	
38	389	Lift the dot socket fastener on tonneau tie strip	1	
39	4221	Durable dot button on hood - chromed	2	} Hood to windscreen frame
40	9306	Durable dot socket on hood - chromed	2	
41	10085	Pop rivet	2	
42	203055	Durable dot fastener on windscreen frame - chromed	2	
43	12894	Hood catch side valance - chromed	2	} Hood to windscreen pillar
44	9636	Bracket on windscreen pillar	2	
45	19256	Rivet	4	
46	19308	Cap for rivet	4	
47	389	Lift the dot socket fastener	14	} Hood and tonneau to rear decking panel
48	390	Lift the dot clinch plate	14	
49	3533	Lift the dot peg - height: 3/8"	14	
50	18071	Self tapping screw	28	

Note:
 Ask for f.o.c. colour samples.
 For details please look at the last page of this catalogue.

Duster
 made of 100% soft cotton. Lifts dust without scratching the paint.
 Part no. 318723



Note: Hood materials and specifications:
 A: **Heavy duty vinyl** - a popular grade material specifically formulated to reproduce the texture and appearance of the vinyl hoods on most British sports cars. The typical life expectancy for this material is over 5 years. Available in black only. B: **Everflex Vinyl** - used as Original Equipment by most British sports car Manufacturers. Our Everflex hoods and tonneaus are considered to be the best choice for those seeking to retain that „original factory appearance“. The typical life expectancy for this material is over 10 years. Various colours available. C: **Double duck** - a 20 oz canvas hooding fitted as standard to many classic cars. This material is popular as a direct replacement to a vinyl hood, offering improved insulation properties in comparison to vinyl hoods. Available in black only. D: **Mohair** - a superior quality canvas material considered to be the finest car hooding material available and used as original equipment by many of the worlds luxury car manufacturers. We have seen 20 plus years old examples of hoods made from this fabric that still look as good as new. Mohair does not require any special treatments and is available in various colours.

20.18

Seats and interior trim Hood, tonneau and hood cover - TR4A

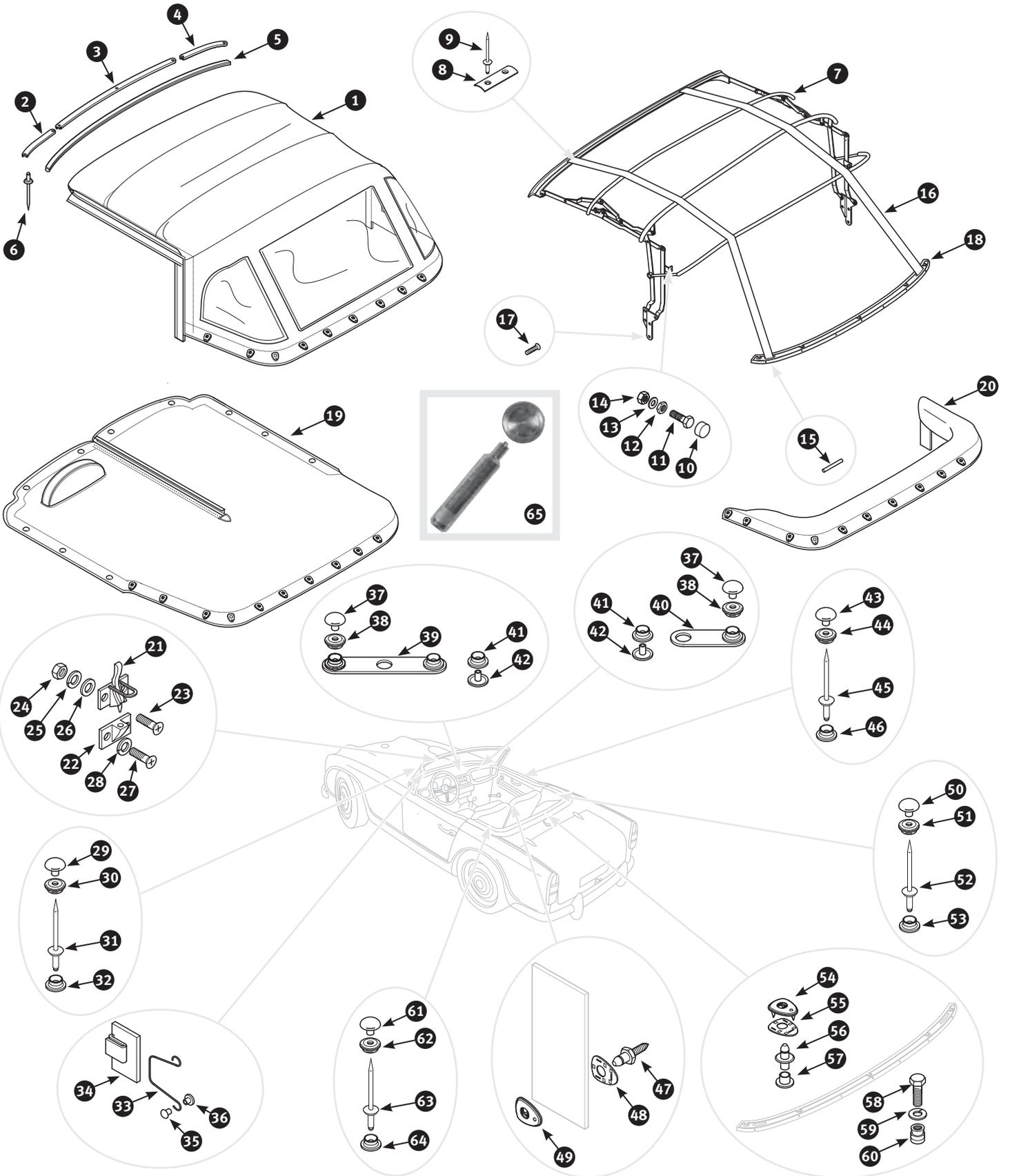

No	Part No	Description	Qty	Notes
1	14261	Vinyl hood black - heavy duty material	1	
1	373554	Vinyl hood black - everflex material.	1	
1	315725	Canvas hood black - double duck material.	1	
1	289412	Mohair hood black.	1	
2	1354	Aluminium retainer hood seal - LH	1	
3	1645	Aluminium retainer hood seal - centre	1	
4	1766	Aluminium retainer hood seal - RH	1	
5	123	Hood seal	1	
6	10085	Pop rivet retainer to hood frame.	9	
7	1654	Hood anchor bar rear.	1	
8	212813	Hood frame	1	
9	1825	Clamping plate	8	} Secures webbings to hood frame sticks
10	10085	Pop rivet	16	
11	296929	Rebound buffer hood frame	2	
12	3072	Screw	2	
13	7656	Nut - locking.	2	
14	212191	Plain washer	2	
15	2828	Nut	2	
16	17488	Steady pin hood to rear anchor bar.	2	
17	16494	Webbing hood - in black	2	
18	7860	Countersunk screw hood frame to body.	6	} Alternatives
18	1134	Countersunk screw hood frame to body - with locking patch	6	
19	336735	Vinyl tonneau black - heavy duty material	1	} LHD cars
19	373757	Vinyl tonneau black - everflex material	1	
19	372861	Canvas tonneau black - double duck material	1	
19	317501	Mohair tonneau black	1	} RHD cars
19	347863	Vinyl tonneau black - heavy duty material	1	
19	331045	Vinyl tonneau black - everflex material	1	
19	311471	Canvas tonneau black - double duck material	1	
19	468352	Mohair tonneau black	1	
20	327508	Vinyl hood cover black - heavy duty material	1	
20	373888	Vinyl hood cover black - everflex material	1	
20	327509	Canvas hood cover black - double duck material	1	
20	327510	Mohair hood cover black	1	
21	21369	Hood catch front - chromed	2	} Hood to windscreen frame
22	10446	Bracket on windscreen frame	2	
23	11320	Countersunk screw hood catch to hood frame	4	
24	215477	Nut	4	
25	212190	Spring washer	4	
26	11231	Plain washer	4	
27	11320	Countersunk screw bracket to windscreen frame.	4	
28	212190	Spring washer	4	

Note:
 Ask for f.o.c. colour samples.
 For details please look at the last page of this catalogue.

Note: Hood materials and specifications:

A: **Heavy duty vinyl** - a popular grade material specifically formulated to reproduce the texture and appearance of the vinyl hoods on most British sports cars. The typical life expectancy for this material is over 5 years. Available in black only. B: **Everflex Vinyl** - used as Original Equipment by most British sports car Manufacturers. Our Everflex hoods and tonneaus are considered to be the best choice for those seeking to retain that „original factory appearance“. The typical life expectancy for this material is over 10 years. Various colours available. C: **Double duck** - a 20 oz canvas hooding fitted as standard to many classic cars. This material is popular as a direct replacement to a vinyl hood, offering improved insulation properties in comparison to vinyl hoods. Available in black only. D: **Mohair** - a superior quality canvas material considered to be the finest car hooding material available and used as original equipment by many of the worlds luxury car manufacturers. We have seen 20 plus years old examples of hoods made from this fabric that still look as good as new. Mohair does not require any special treatments and is available in various colours.

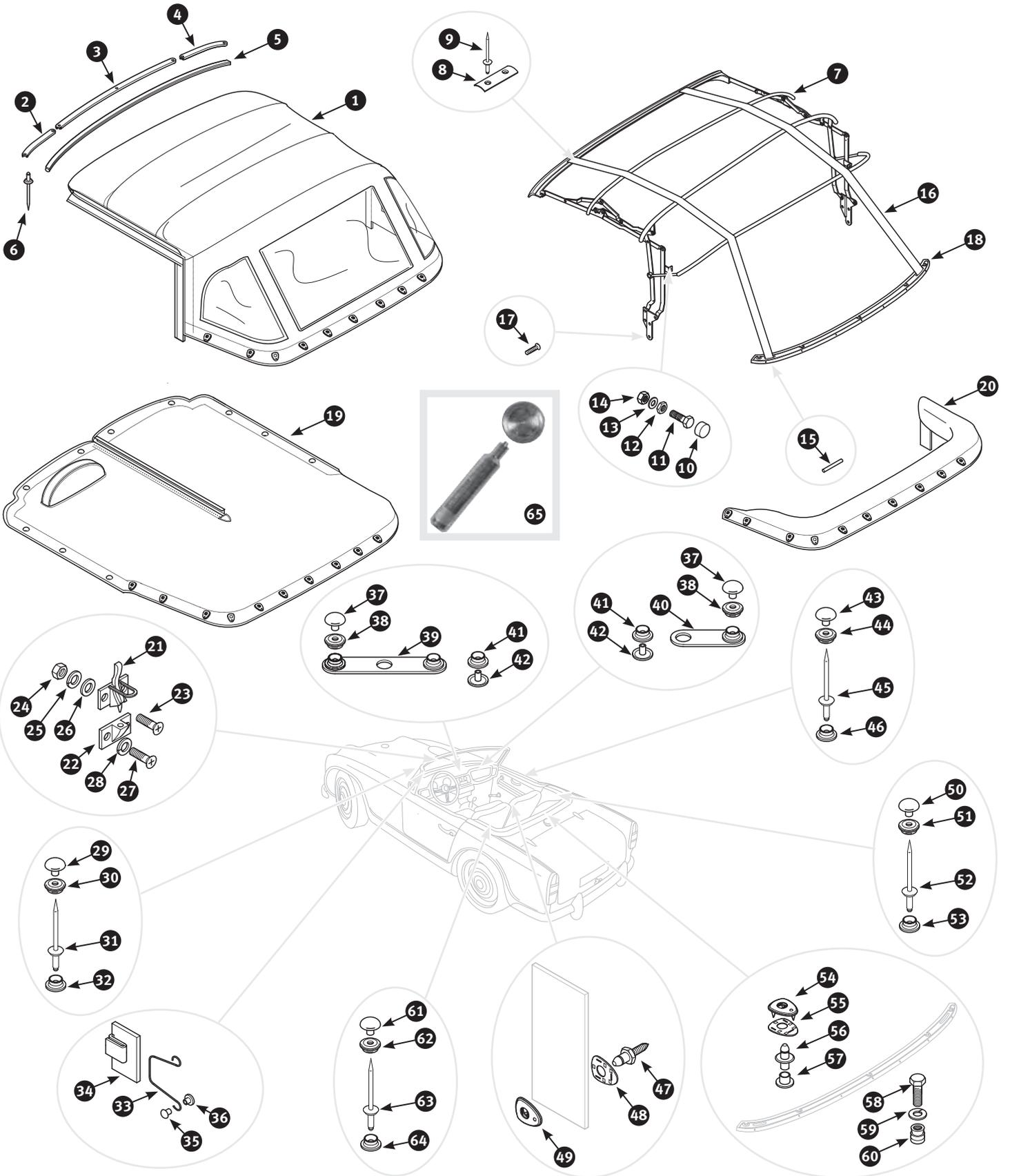

No	Part No	Description	Qty	Notes
29	4221	Durable dot button on hood - chromed	2	Hood to windscreen frame
30	9306	Durable dot socket on hood - chromed	2	
31	10085	Pop rivet	2	
32	203055	Durable dot fastener on windscreen frame - chromed	2	Hood to windscreen pillar
33	12894	Hood catch side valance - chromed	2	
34	9636	Bracket on windscreen pillar	2	
35	19256	Rivet	4	
36	19308	Cap for rivet	4	
37	4221	Durable dot button on tonneau - chromed	4	Tonneau to scuttle panel
38	9306	Durable dot socket on tonneau - chromed	4	
39	3740	Bracket - centre	1	
40	3741	Bracket - outer	2	
41	203055	Durable dot fastener - separately	4	
42	9307	Durable dot base - separately	4	
43	4221	Durable dot button on tonneau - chromed	6	Tonneau to door
44	9306	Durable dot socket on tonneau - chromed	6	
45	4870	Pop rivet	6	
46	203055	Durable dot fastener on door - chromed	6	
47	11415	Lift the dot peg on passenger seat	1	Tonneau tie strip to passenger seat
48	390	Lift the dot clinch plate on tonneau tie strip	1	
49	389	Lift the dot socket fastener on tonneau tie strip	1	
50	4221	Durable dot button on hood cover	4	Hood cover to rear quarter panel
51	9306	Durable dot socket on hood cover	4	
52	10085	Pop rivet	4	
53	203055	Durable dot fastener on rear quarter panel	4	
54	389	Lift the dot socket fastener	7	Hood, tonneau and hood cover to hood anchor bar
55	390	Lift the dot clinch plate	7	
56	10436	Lift the dot peg in hood anchor bar	7	
57	21362	Fixing pin on lift the dot peg	7	
58	3120	Pointed screw	5	Hood anchor bar to rear decking panel
59	212192	Spring washer	5	
60	25711	Rivet with thread	5	
61	4221	Durable dot button	6	Hood, tonneau and hood cover to forward decking panel
62	9306	Durable dot socket	6	
63	10085	Pop rivet	6	
64	203055	Durable dot fastener on decking panel	6	
65	17381	Tool for Durable Dot buttons	1	

Note:
 Ask for f.o.c. colour samples.
 For details please look at the last page of this catalogue.

Note: Hood materials and specifications:

A: **Heavy duty vinyl** - a popular grade material specifically formulated to reproduce the texture and appearance of the vinyl hoods on most British sports cars. The typical life expectancy for this material is over 5 years. Available in black only. B: **Everflex Vinyl** - used as Original Equipment by most British sports car Manufacturers. Our Everflex hoods and tonneaus are considered to be the best choice for those seeking to retain that „original factory appearance“. The typical life expectancy for this material is over 10 years. Various colours available. C: **Double duck** - a 20 oz canvas hooding fitted as standard to many classic cars. This material is popular as a direct replacement to a vinyl hood, offering improved insulation properties in comparison to vinyl hoods. Available in black only. D: **Mohair** - a superior quality canvas material considered to be the finest car hooding material available and used as original equipment by many of the worlds luxury car manufacturers. We have seen 20 plus years old examples of hoods made from this fabric that still look as good as new. Mohair does not require any special treatments and is available in various colours.

20.19

Seats and interior trim Hard top - TR2, TR3, TR3A and TR3B

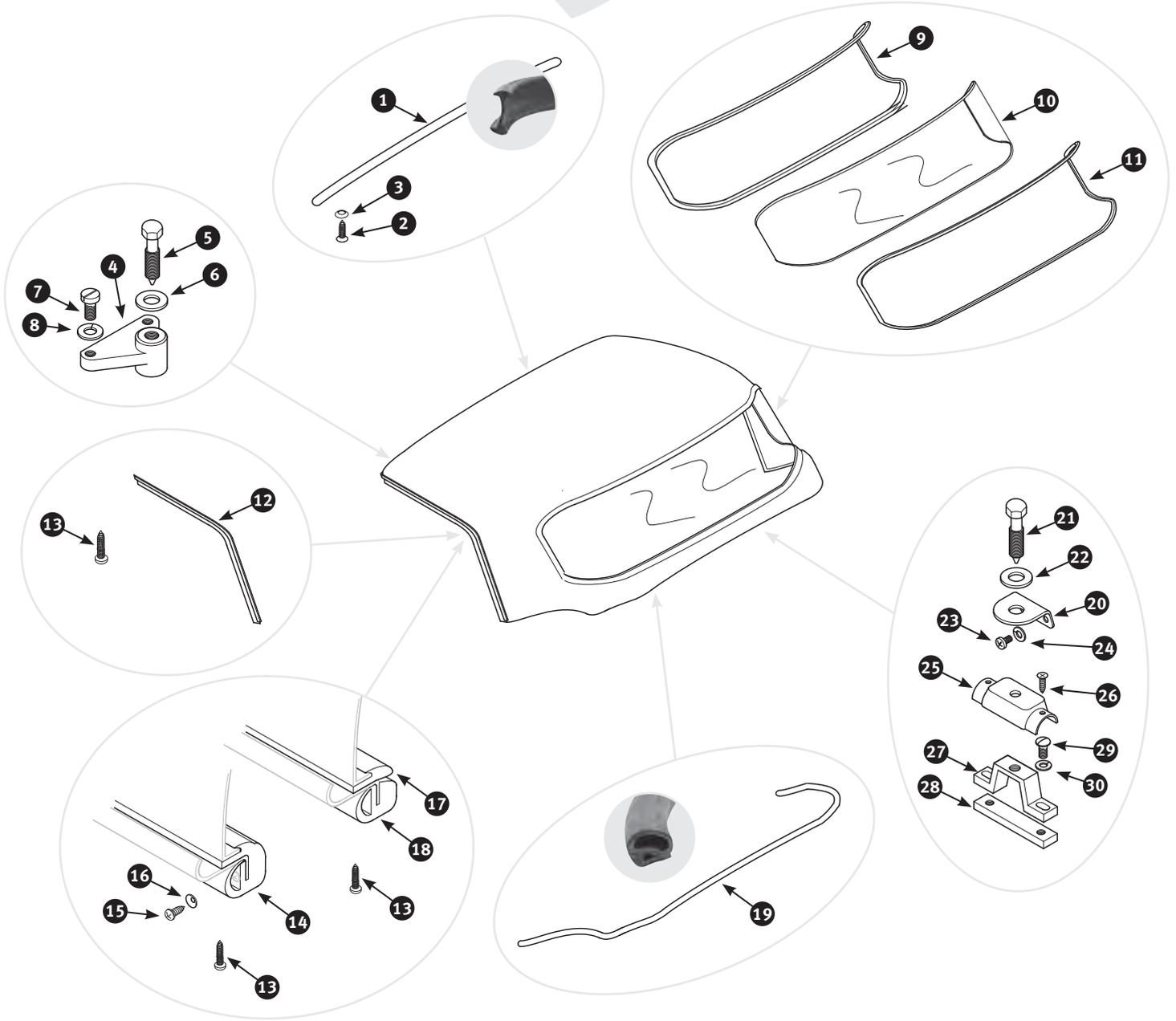

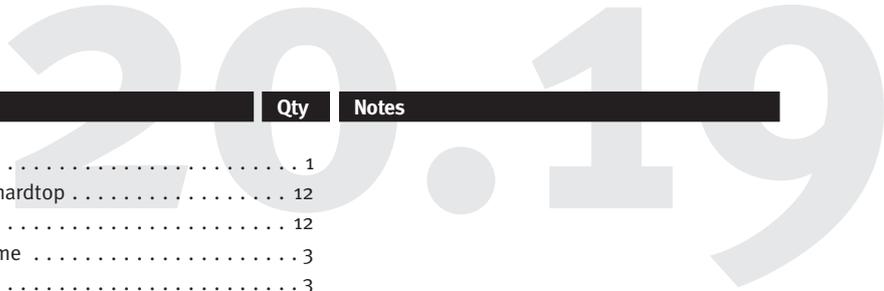

No	Part No	Description	Qty	Notes
1	2499	Rubber seal hardtop front	1	
2	11049	Self tapping screw rubber seal to hardtop	12	
3	12587	Cup washer	12	
4	2496	Bracket hardtop to windscreen frame	3	
5	2491	Pointed screw hardtop to bracket	3	
6	10387	Plain washer chromed	3	
7	12933	Screw bracket to windscreen frame	6	
8	212190	Spring washer	6	
9	2478	Sealing rubber rear hardtop screen	1	
10	15485	Rear hard top screen perspex	1	} Comes with oversize
11	215857	Filler strip rear hardtop screen	1	
12	215854	Drip rail hardtop - LH.	1	
12	215853	Drip rail hardtop - RH	1	
13	3818	Self tapping screw drip rail to hardtop.	12	
14	300467	Rubber seal hardtop drip rail	2	} Early type. May be replaced by the later 2-piece rubber and furflex seal (ill. 17 and 18)
15	11049	Self tapping screw rubber seal to drip rail	14	
16	12587	Cup washer	14	} Later type. Must be used together with one of our furflex seals (ill. 18)
17	2502	Rubber seal hardtop drip rail	2	
18	318273	Furflex door seal black.	2	} Supplied per metre - must be used together with our rubber seal 2502 (ill. 1)
18	336549	Furflex door seal navy	2	
18	318274	Furflex door seal red	2	
18	337323	Furflex door seal grey	2	
18	337327	Furflex door seal suede green.	2	
19	215852	Rubber seal hardtop to rear decking panel.	1	
20	200521	Cover hardtop retaining - rear.	2	
20	300788	Cover hardtop retaining - centre	1	
20	300787	Cover hardtop retaining - side.	2	
21	2494	Pointed screw hardtop to clamp bracket	5	
22	7794	Plain washer	5	
23	7852	Panhead screw fixing cover on hardtop	5	
24	209089	Shakeproof washer	5	
25	412	Clamping plate hardtop - side.	2	
25	413	Clamping plate hardtop - rear and centre.	3	
26	5692	Self tapping screw clamping plate to tonneau capping	10	
27	2493	Clamp bracket hardtop to rear decking panel	5	
28	2492	Tapped plate for clamp bracket.	5	
29	13660	Panhead screw clamp plate to rear decking panel.	10	
30	212190	Spring washer	10	
31	327454	Hard top black fibreglass	1	
31	299876	Hard top white fibreglass	1	
32	4066	Fitting kit hardtop	1	
33	349251	Plastic cleaner with gleam-alcohol, 500 ml handsprayer	1	} For the gentle cleaning of all water resistant plastic surfaces outside of the car

20.20

Seats and interior trim Hard top and surrey top - TR4 and TR4A

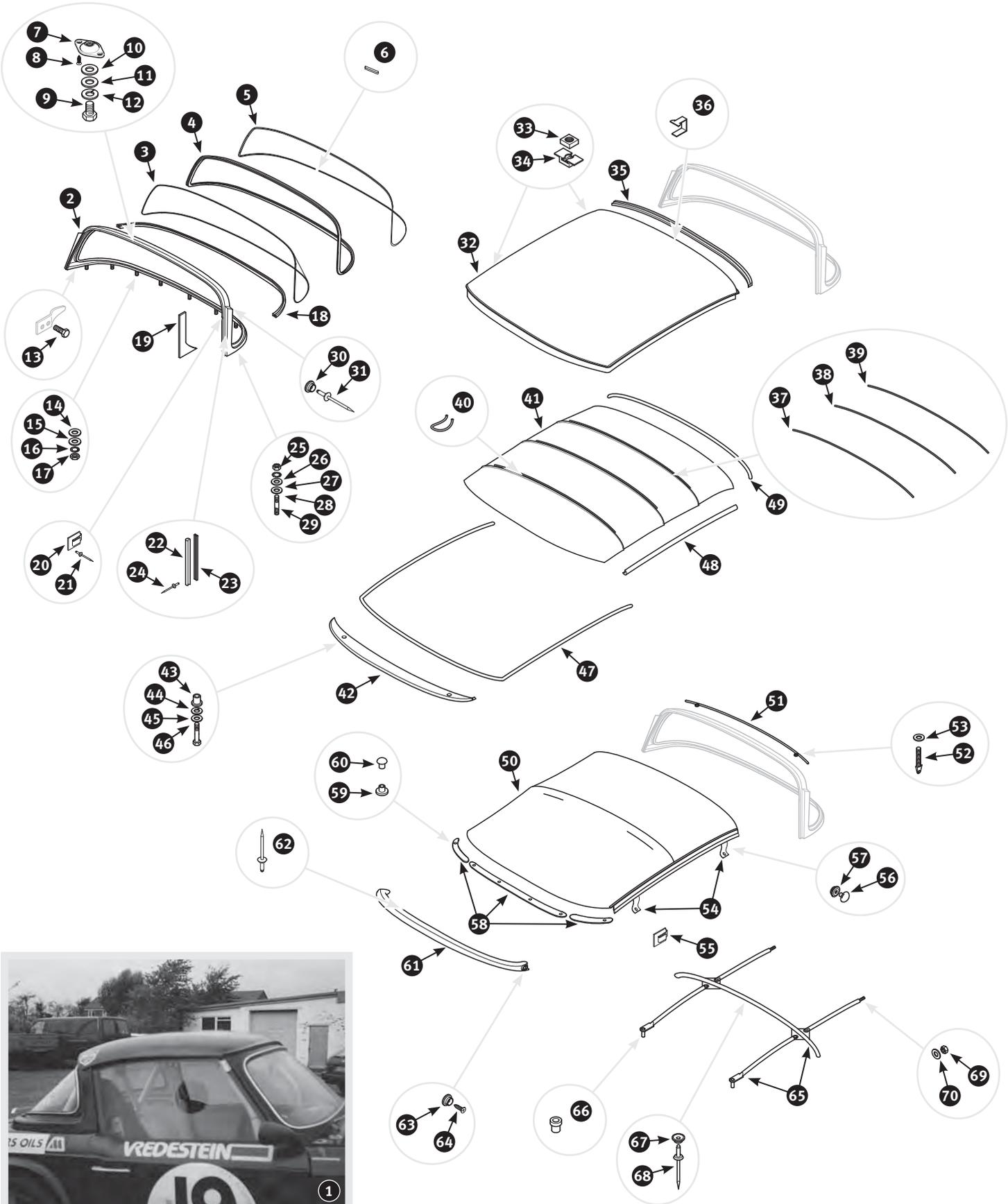

No	Part No	Description	Qty	Notes
1	293958	Hard top in black	1	} Fibreglass. One piece racing spec.
1	448649	Hard top in white	1	
2	202515	Frame for rear screen - fibreglass	1	} Alternatives
3	19123	Rear screen surrey top - glass.	1	
3	323901	Rear screen surrey top - perspex.	1	} Chromed plastic
4	10854	Glazing rubber rear screen	1	
5	2187	Filler strip rear screen glazing rubber.	1	} Hard top to screen frame
6	9559	Finishing clip filler strip	1	
7	478654	Cover plate in rear screen frame - stainless steel	2	} Hard top to screen frame
8	16158	Self tapping screw	4	
9	10376	Screw chromed	2	
10	9418	Fibre washer - may replace original rubber washer	2	
11	10387	Plain washer chromed	2	
12	212194	Spring washer	2	} Screen frame to decking panel - centre fixing
13	7853	Panhead screw - fitted to hood frame fixing tapped plates in ,B' post to prevent rattles	4	
14	11441	Fibre washer - may replace original rubber washer	7	} Screen frame to decking panel - centre fixing
15	7794	Plain washer	7	
16	300328	Shakeproof washer	7	
17	2828	Nut	7	
18	421	Rubber seal screen frame to decking panel	1	} Screen frame to decking panel - side fixing
19	300769	Cover screen frame - LH inner.	1	
19	300770	Cover screen frame - RH inner.	1	} Surrey top canopy fixing
20	21432	Clamping plate surrey top canopy.	2	
21	10085	Pop rivet	4	} Surrey top canopy fixing
22	300462	Sealing rubber	2	
23	3736	Channel sealing rubber	2	} Surrey top canopy fixing
24	10085	Pop rivet	8	
25	2828	Nut	2	} Screen frame to decking panel - side fixing
26	300328	Shakeproof washer	2	
27	7794	Plain washer	2	} Screen frame to decking panel - side fixing
28	11441	Fibre washer - may replace original rubber washer	2	
29	19626	Stud	2	} Surrey top canopy fixing
30	203055	Durable dot fastener on rear screen frame.	2	
31	4870	Pop rivet	2	} Surrey top canopy fixing
32	24964	Hard top roof - fibreglass - colour: black	1	
32	325501	Hard top roof - aluminium	1	} Cars with hard top
32	202516	Hard top roof - steel	1	
33	9662	Square nut	4	} Cars with hard top
34	10630	Cage for square nut.	4	
35	300815	Capping rear.	1	} Cars with hard top and original headlining
36	21754	Retaining clip rear capping.	9	
37	338047	Stay headlining - front	1	} Cars with hard top and original headlining
38	338048	Stay headlining - centre	1	
39	338049	Stay headlining - rear.	1	} Cars with hard top and original headlining
40	10445	Retaining clip headlining to stay.	6	
41	323902	Headlining kit pop-in fibreglass replacement	1	} Cars with hard top. Replaces ill. 37 to 40

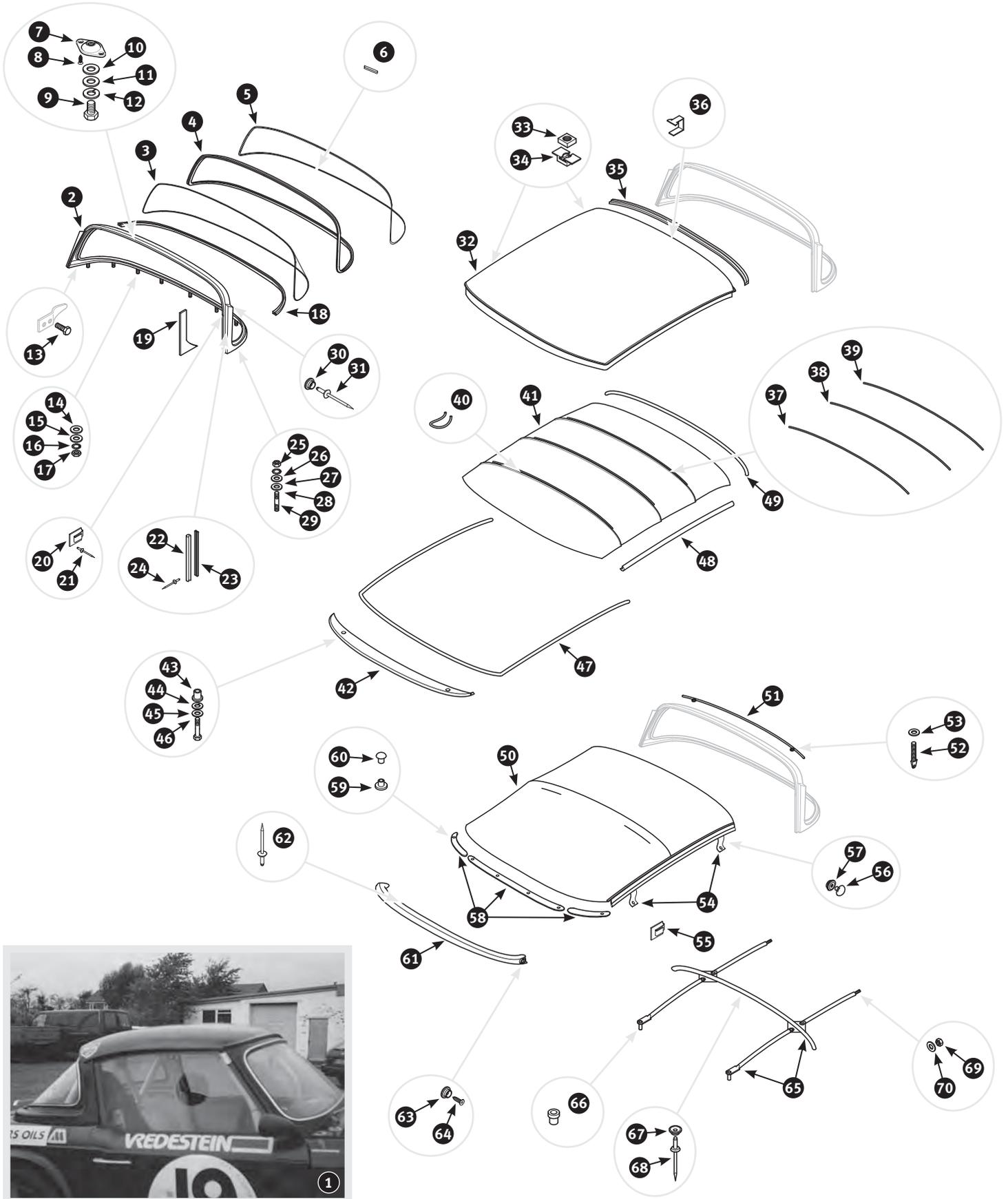

No	Part No	Description	Qty	Notes
42	17336	Sealing rubber hard top - front	1	Cars with hard top
43	24913	Distance tube hard top to windscreen frame	2	
44	212194	Spring washer	2	
45	10387	Plain washer chromed	2	
46	21143	Bolt hard top to windscreen frame	2	
47	326078	Draught excluder black.	1	
47	293703	Draught excluder midnight blue	1	
47	337836	Draught excluder red	1	
48	300462	Sealing rubber hard top to door glass	2	
49	15506	Sealing rubber hard top to rear screen frame	1	
50	146	Surrey top canopy black - Vinyl material	1	Cars with surrey top
50	316374	Surrey top canopy black - Double Duck material.	1	
50	331091	Surrey top canopy black - Mohair material.	1	
51	11234	Retainer surrey top to rear screen frame	1	
52	11237	Thumb screw surrey top to rear screen frame - chromed	2	
53	10387	Plain washer chromed	2	
54	12894	Hood catch surrey top canopy - chromed.	4	
55	9636	Bracket securing surrey top catch on windscreen pillar	2	
56	4221	Durable dot button on surrey top	10	
57	9306	Durable dot socket on surrey top	10	
58	18688	Hood stiffener surrey top - 3 piece	1	
59	19256	Rivet retaining surrey top stiffener	4	
60	19308	Cap for rivet	4	
61	20117	Aluminium cover top of windscreen frame	1	
62	10085	Pop rivet	9	
63	203055	Durable dot fastener on aluminium cover.	2	
64	13853	Self tapping screw for durable dot fastener	2	
65	145	Framework surrey top canopy.	1	
66	21142	Rubber bush	2	
67	203055	Durable dot fastener on framework.	6	
68	10085	Pop rivet	6	
69	7741	Nut on framework - rear.	2	
70	212195	Plain washer	2	

Sewing awl

supplied in a 5 piece set. Contents: 1 sewing awl with a nice wooden handle, 2 spare needles and 180 yards of extra thread. The special saddler tool for leather and thick materials. The Sewing Awl sews a lock stitch just like a machine and is the perfect device for sewing heavy leather, vinyl or cloth. Also works great for upholstery and auto tops, vinyl and leather repairs. Made in USA.

Part no. 369532

Needle

for sewing awl above

straight, fine. Part no. 487348

straight, coarse. Part no. 487347

curved, coarse Part no. 487346

Thread

waxed Polyester, tan, 160 meter

coarse Part no. 487349

fine Part no. 487350



Note:
Ask for f.o.c. colour samples.
For details please look at the last page of this catalogue.

- **Online shop**
- **From the drawing to the shopping cart**
- **24 hours a day, 7 days a week**

www.Limora.com
www.ScParts.co.uk



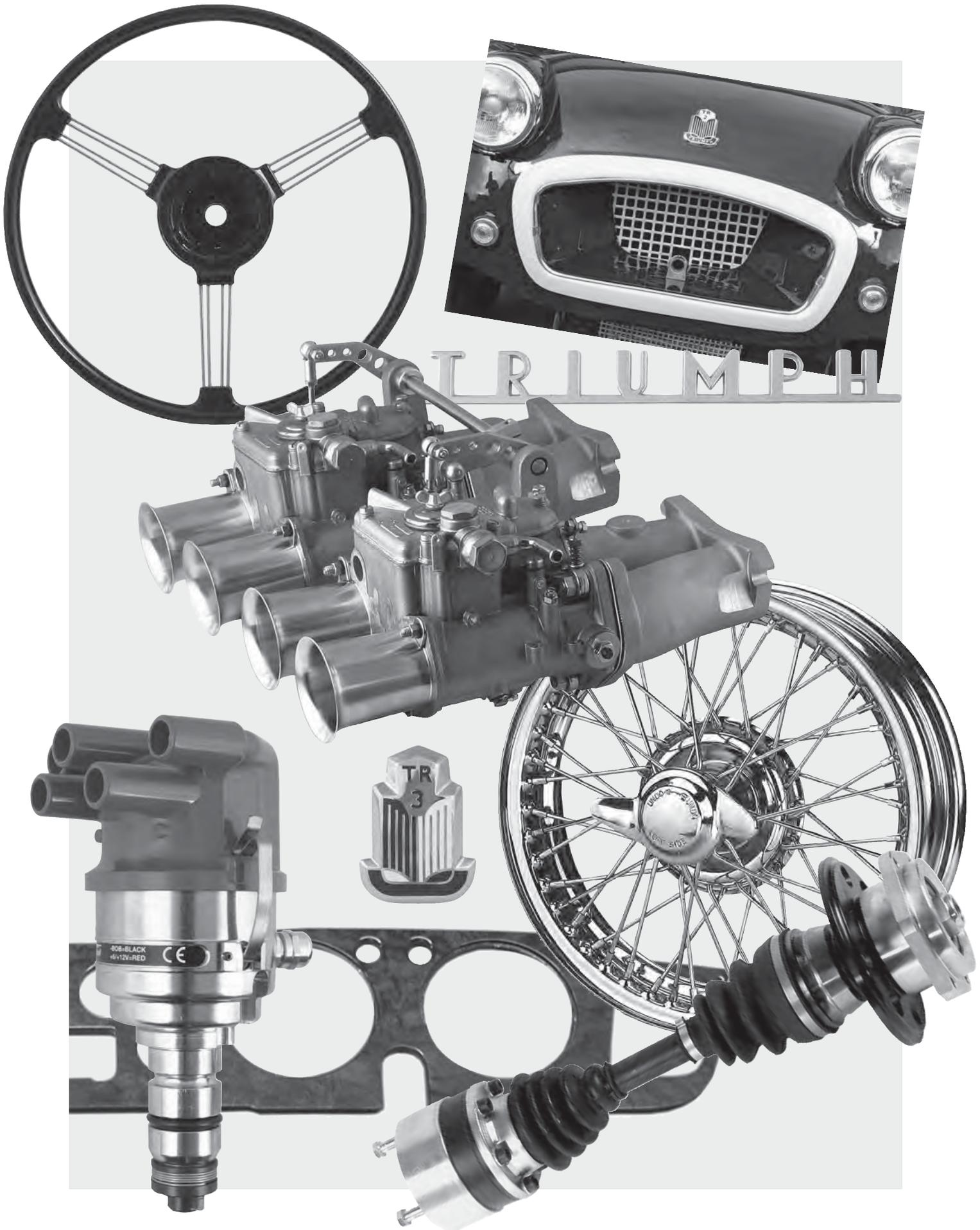

21.1

Competition parts and accessories

Cylinder block and crankshaft



- 1 **10832** Oil sump aluminium.
Features: external bracing and integral top oil splash plate
- 1 **478587** Oil sump magnesium.
Features: external bracing, integral top oil splash plate and additional anti-surge baffle plates
- no ill. **478586** Fitting kit for alloy and magnesium oil sumps
- 2 **324537** Oil pump updated,
for maximum oil delivery to update any engine
- 3 Kent Camshafts - new items
 - 302899** 280°
power band: 2200 to 7000 rpm,
valve timing: 37/63 and 73/27, 280°/280°,
cam lift: 0.293"
 - 302902** 290°
power band: 3000 to 7500 rpm,
valve timing: 42/68 and 78/32, 290°/290°,
cam lift: 0.309"
 - 342026** 300°
power band: 3750 to 8000 rpm,
valve timing: 47/73 and 83/37, 300°/300°,
cam lift: 0.324"
- 4 **14656** Crankshaft forged from EN40B steel,
nitride and cross drilled. Ready ground to suit our rear oil seal
- 5 Forged aluminium pistons
for road, competition and full race engines. Supplied complete with piston rings and gudgeon pins. We recommend to use our Composite cylinder head gasket.
 - 327466** 3-ring circlip piston, bore size: 87 mm

4 Catalogues, you must have: f.o.c.

- Accessories
- Tuning and more



Tools •
Oils and lubricants •

Order online: www.Limora.com • www.scparts.co.uk



6



7



8



9



10



11



12



13



14

- 6 Mahle Piston sets with liners assembly
20830 86.0 mm bore size
26225 87.0 mm bore size
- 7 **324539** Con rod forged steel, H beam type, complete with bolts
- 8 **293174** ARP Stud kit for standard con rods. Made of high grade 8740 chrome moly steel and heat treated to a nominal tensile strength of 200,000 psi. Threads are rolled after heat treat to ensure optimum fatigue strength. They are fully capable of handling the extra stress of high combustion pressure engines
- 9 **204624** Pulley crankshaft, made from alloy. For 3/8" fan belt conversions.
- 10 **26343** Oil seal conversion kit, crankshaft rear. Please note: crankshaft flange needs some modification. Please find single components for individual conversion below
- no ill. **315241** Oil seal separately, for oil seal conversion kit 26343 (ill. 9)
- 11 **337600** Housing distributor and tachometer drive, made from aluminium
- 12 **12868** Cam follower, fully heat treated steel version. Height: 50mm, weight: 71g. Recommendable for all fast road and race engines
- 13 **363161** Cam follower, lightweight and fully heat treated steel version. Height: 39mm, weight: 53g. Recommendable for all fast road and race engines
- 14 **12126** Push rod competition type with unfinished length. Tubular pushrod for standard cam followers. Made from 4130 Chrome Moly steel for extra strength and resistance to bending at high rpm. These have the bottom ball of the pushrod fitted, and the top cup unfitted. This allows you cut to length to accommodate skimmed cylinder heads, decked blocks, different valve heights etc and achieve optimum rocker angles. The top cup presses in- and will not come out.

21.1

Competition parts and accessories

Cylinder block and crankshaft



- 15 **18198** Oil filter for spin on conversion
- 16 **25212** Oil filter adaptor for spin on conversion TR2 to TR4
- 17 **3117** Oil filter adaptor for spin on conversion TR4A
- 18 **FilterMAG**
FilterMAG's powerful rare-earth magnets trap and hold wear-inducing metal particles smaller than 40 microns down to 1 micron that the filter cannot stop. It extends oil life and reduces maintenance costs. Easy fitting while magnetic force „snaps“ FilterMAG to the filter canister. FilterMAG has a lifetime warranty.
 - 481133** standard type,
for oil filters from 2.90“ to 3.40“ diameter,
height 2.0“
 - 481135** high performance type,
for oil filters from 2.90“ to 3.40“ diameter,
height 2.625“
- 19 **Hylomar**
 - 3476** Universal jointing compound
100g. tube
 - 355145** High performance jointing compound
„Racing Formula“ with increased adhesive properties,
ideal for competition use
75g. tube

4 Catalogues, you must have: f.o.c.

- Accessories
- Tuning and more



Tools •
Oils and lubricants •

Order online: www.Limora.com • www.scparts.co.uk

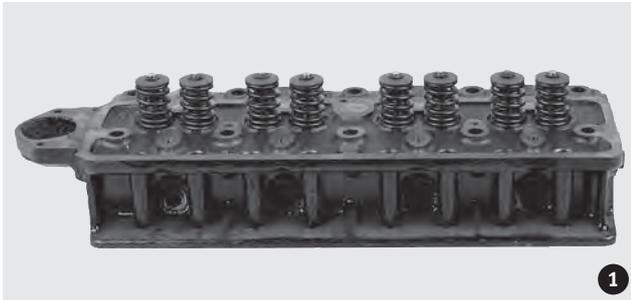

1

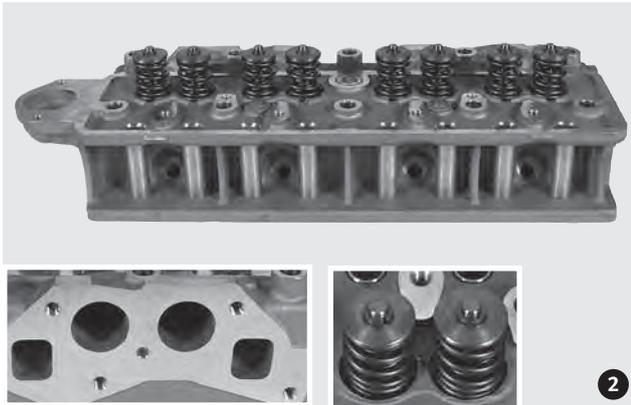

2

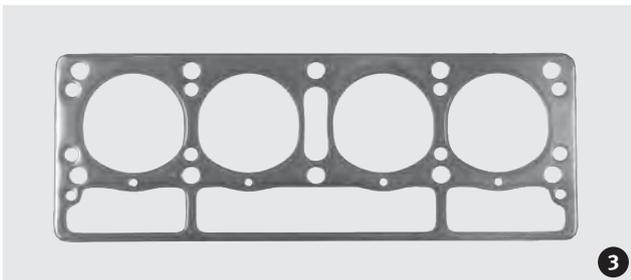

3



4

- 1 Cylinder heads made from cast iron suitable for lead free applications
 - 18087** Cylinder head - exchange
,Low port' type complete with valves springs
TR2, TR3 to engine no. TS13051
 - 210207** Cylinder head - exchange
,High port' type complete with valves and springs
TR3 from engine no. TS13052, TR3A to TR4A
 - 212628** Cylinder head - new item
,High port' type without valves, valve guides and valve seat inserts
TR3 from engine no. TS13052, TR3A to TR4A
- 2 Cylinder heads made from aluminium
These replacement cylinder heads are made from cast LM25 aluminium alloy with a specially designed figure of eight valve seat integrally cast in. These inserts are made of a special stainless steel alloy to enable them to use unleaded fuel. This material has the same coefficient of expansion as LM25 aluminium and hence there is no possibility of the seat coming loose. As well as the obviously better heat dissipation of aluminium, it's use of allows a higher compression ratio to be used than would be possible with cast iron (approximately 0.5 of a ratio for the same type of fuel). There is also a weight saving, thus improving the weight distribution and therefore the handling characteristics of the car. Specifications: fully machined, balanced and polished combustion chambers with bronze valve guides and lead free valve seats.
 - 328185** Cylinder head - new item
,High port' type complete with valves, valve guides and valve springs
TR3 from engine no. TS13052, TR3A to TR4A
 - 2 **319160** Cylinder head - new item
,High port' type with valve guides and valve seats
TR3 from engine no. TS13052, TR3A to TR4A
- 3 Composite cylinder head gaskets
The genuine cylinder head gasket for the classic Triumph 4 cylinder engine were originally just made of plain copper and known for corrosion and other problems. We can offer a composite head gasket of the latest design, using the most advanced manufacturing techniques. With our new gasket made from high quality composite material you have the following benefit:
 - stronger support for oil and water galleries
 - bigger bore sizes possible
 - higher compression possible
 - improved design for reliability
 - 320514** Bore size: 83 to 86 mm
thickness: 0.60", built-in thickness: 0.57"
 - 336961** Bore size: 83 to 86 mm
thickness: 0.35", built-in thickness: 0.33" (for full race engines)
 - 10579** Bore size: 87 mm
thickness: 0.60", built-in thickness: 0.57"
- 4 **362049** ARP Studs and nuts - cylinder head
high grade 8470 chrome moly with a tensile strength of 190.000 psi ensure substantial strength and reduces stretching

21.2

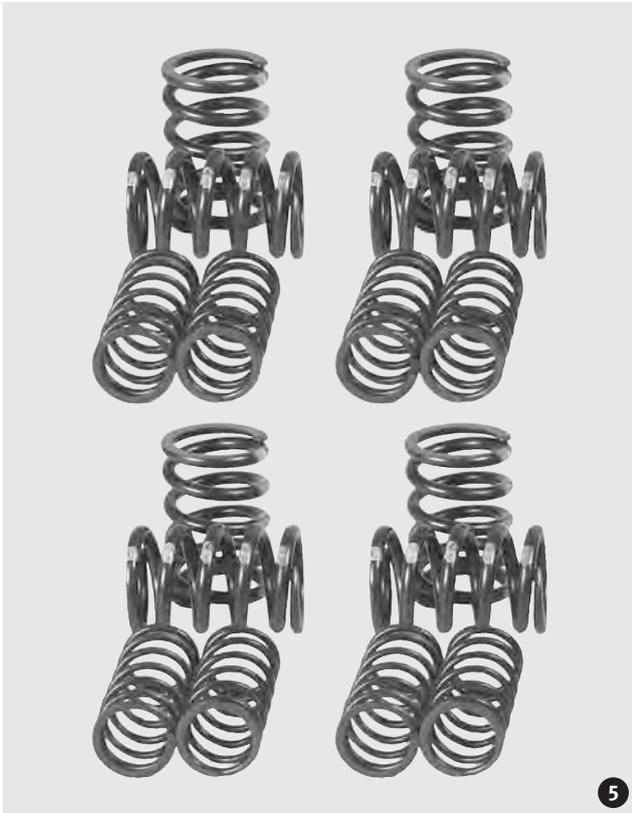

- 5 Valve springs
 - 1097** Complete car set with triple exhaust and double inlet valve springs
TR2 to TR3A, TR4 to engine no. CT21470
 - 304999** Stem diameter 3/8"
TR2 to TR3A, TR4 to engine no. CT21470
 - 13135** Stem diameter 5/16"
TR4 from engine no. CT21471, TR4A
 - 318593** Stem diameter 5/16" and 17/32" outer diameter.
Allows to run ,late' valves in ,early' heads
TR2 to TR3A, TR4 to engine no. CT21470

 - 1098** Complete car set with double exhaust and inlet valve springs
TR4 from engine no. CT21471, TR4A
- 7 **12871** Valve spring cap - aluminium,
for double inlet and exhaust valve springs
TR4 from engine no. CT21471, TR4A
- 8 Gas flowed stainless steel valves with 5/16" stem diameter
TR4 from engine no. CT21471, TR4A. The fitting in conjunction
with our valve guides 318593 (ill. 5) allows to run these ,late'
valves in ,early' heads
 - 12602** Inlet valve
head diameter: 1.655"
- 9 Gas flowed stainless steel valves with 5/16" stem diameter
TR4 from engine no. CT21471, TR4A. The fitting in conjunction
with our valve guides 318593 (ill. 5) allows to run these ,late'
valves in ,early' heads
 - 12605** Exhaust valve
head diameter: 1.437"

4 Catalogues, you must have: f.o.c.

- Accessories
- Tuning and more



Tools •
Oils and lubricants •

Order online: www.Limora.com • www.scparts.co.uk

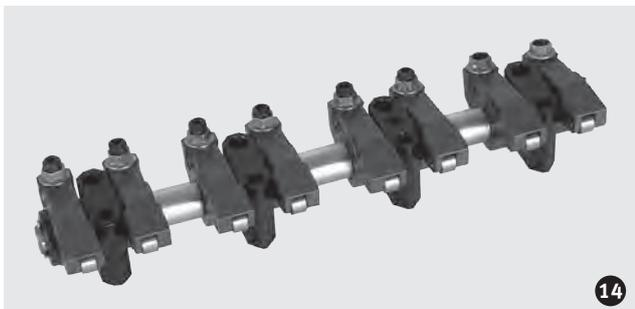
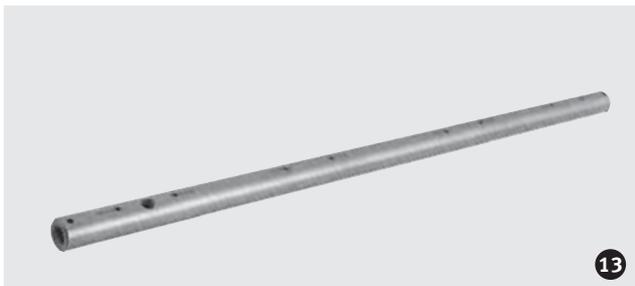

- 10 **13573** Oil feed pipe for external rocker shaft lubrication
- 11 **324532** Pedestal - made from aluminium, supplied in sets of 4
- 12 **13050** Rocker shaft - tufride
- 13 **13051** Spacer set for rocker shaft made from high quality steel
- 14 **327463** Rocker kit roller tip type with needle bearings, valve lift: 1.5:1
If high ratio rocker kits will be fitted always check valve clearance to block and pistons, may be additional machining is required. also check the lift capabilities of the valve springs for coil binding. Alternatively fitting of a cam with lower valve lift is required.
Please note: must be used with aluminium rocker cover
- 15 **4014** Rocker cover - polished aluminium, non vented. Comes with oil filler cap TR2 to TR4
- 16 **4015** Rocker cover - polished aluminium, vented. Comes with oil filler cap TR4A

Please find single components for individual rocker cover conversion below

- no ill. **15742** Oil filler cap - separately
- no ill. **203987** Stud for alloy rocker cover
- no ill. **974** Rocker cover gasket

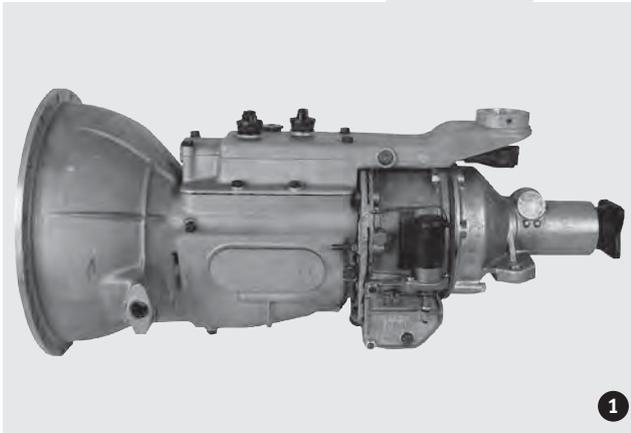

1



2



3

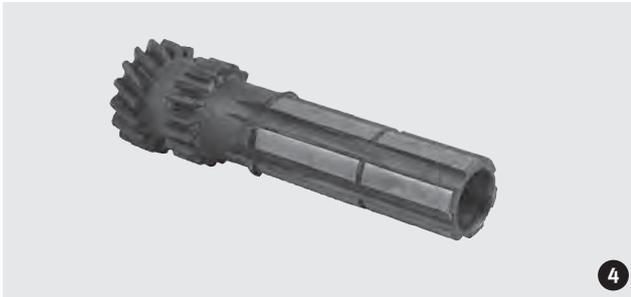

4

- 1 Gearbox with ,A' type overdrive, reconditioned, outright
- 485394** 3 synchro box. Main characteristics: clutch housing adapts early ,Bomb' type starter motor TR2 and TR3, TR3A to TS50000
- 485395** 3 synchro box. Main characteristics: clutch housing adapts late ,Long' type starter motor TR3A from TS50001
- 485396** 4 synchro box. Main characteristics: clutch housing adapts late ,Long' type starter motor TR3B, TR4 and TR4A
- 2 **336340** Angle drive - speedometer cable to overdrive perfect uprated quality TR4A
- 3 **17855** Accumulator piston competition type with two uprated springs and a larger piston TR4A IRS fitted with overdrive unit 22/61753
- no ill. **355745** Spring for accumulator piston 17855 supplied in pairs TR4A IRS fitted with overdrive unit 22/61753
- 4 Lay gear for 4 synchro gearbox uprated type with pre-fitted bearings TR3B, TR4 and TR4A
- 342119** Variant with 17 teeth
- 337474** Variant with 16 teeth

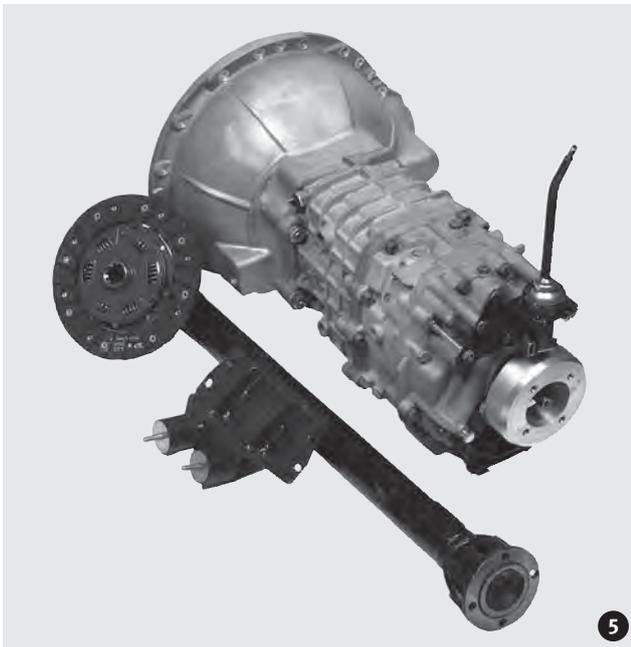

5



6



7

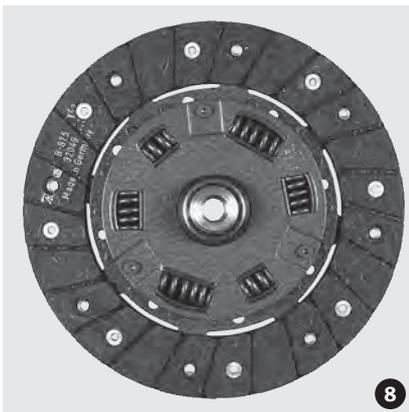

8

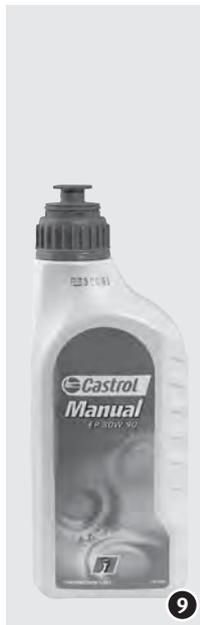

9

- 5 **325726** Getrag 5-speed gearbox complete kit ready to bolt on
This kit comprising a special bellhousing, clutch plate, release roller bearing, spigot bush for crankshaft, gear stick, special speedo drive to use with the genuine speedo cable, special bracket to mount gearbox at original crossmember and an exchange propshaft. This conversion kit is built to adapt the original release fork and clutch shaft.

Please find single components for individual Getrag conversion below

- 6 **327668** Propshaft - exchange
7 **328991** Clutch release bearing
8 **329767** Clutch plate
9 **290203** Castrol Gearbox oil EP90 - 1 litre bottle

4 Catalogues, you must have: f.o.c.

- Accessories
- Tuning and more



Tools •
Oils and lubricants •

Order online: www.Limora.com • www.scparts.co.uk



1

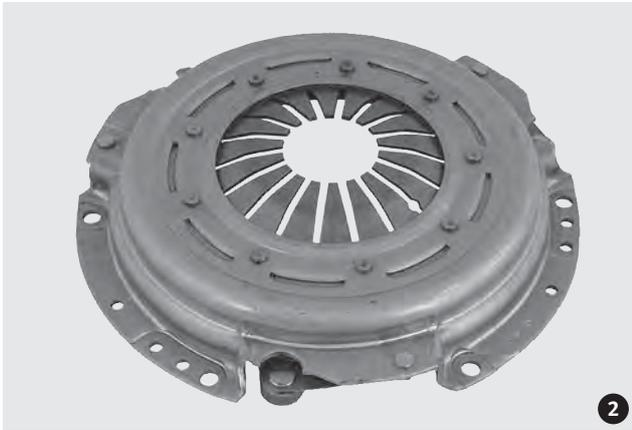

2

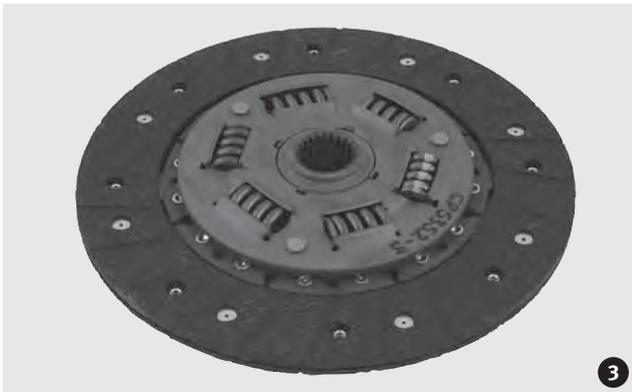

3



4



5



6

1 Flywheel

Our aluminium flywheels are made of the highest quality 6061 T6 aluminium. The material is fantastic for strength, heat dissipation and of course reduction in weight. The friction surface we use is an incredibly strong 1045 steel. The plates are milled to meet our high specifications. The flywheel can mate with any type of clutch material, including organic, kevlar, ceramic, metallic and sintered iron. We attach the replaceable friction surface with military grade aerospace fasteners. With these replaceable plates there is no need to replace the entire flywheel when the clutch or flywheel is at the end of its life, saving time and money. The ring gears we use are also made from 1050 steel and are heat treated for durability. The gears are heated then pressed on and secured with grade 8 button screws. We were the first to utilize a stepped dowel system in most of our flywheel applications. This doweling method ensures that once the pressure plate is installed the dowels cannot be removed because they become locked into place. No steel flywheel can compete with the awesome serviceability, strength and superior design of our aluminium flywheels. If there was a better material out there, we would be using it.

343487 Lightened aluminium type, with ring gear assembly.
Weight: 10kg
TR3A from engine no. TS50001, TR3B, TR4 and TR4A

Upgraded clutch - ,road' type with 8.5" diameter
Please note: these single clutch items must used in sets TR2 to TR4.

- 2 **13140** Clutch cover
- 3 **1100** Clutch plate with 10 splines
- 4 **328991** Clutch release bearing - reinforced roller type complete with sleeve

Upgraded clutch - ,road' type with 8.5" diameter TR4A

- 2 **13140** Clutch cover
 - 3 **13141** Clutch plate with 23 splines
 - 4 **328991** Clutch release bearing - reinforced roller type complete with sleeve
- 5 Alignment tool for clutch
- 16275** Variant with 10 splines - TR2 to TR4
 - 25700** Variant with 23 splines - TR4A
- 6 Clutch hoses - aeroquip type
- 13278** TR2, TR3 to TS13045
 - 14409** TR3 from TS13046, TR3A, TR3B and TR4
 - 14292** TR4A



1



2



3



4



5

- 1 **327489** Aluminium radiator, high performance type characteristic: offset inlet, long filler neck extension but no crank hole
TR2, TR3, TR3A and TR3B, TR4 to CT9552
- 2 **327490** Aluminium radiator, high performance type characteristic: offset inlet, no filler neck extension and no crank hole
TR4 from CT9553
- 3 **327491** Aluminium radiator, high performance type
TR4A
- 4 **25778** Water pipe between water pump and radiator made from stainless steel. Comes with hole to adapt thermo switch for electric fan control
- 5 Thermo switch
fits to stainless steel water pipe 25778 (ill. 4). Please note: choice of thermo switch should be matched to your thermostat. Do not tempted to use one which cuts in at too late temperature. Please remember there is approx. 7° C drop through the radiator.
313475 82°C on / 68°C off - use with 74°C thermostat
313365 86°C on / 76°C off - use with 74° or 82°C thermostat
311660 86°C on / 81°C off - use with 82°C thermostat
313240 88°C on / 79°C off - use with 82° or 88°C thermostat
311661 92°C on / 87°C off - use with 88°C thermostat

**4 Catalogues, you must have:
f.o.c.**

- Accessories
- Tuning and more



Tools •
Oils and lubricants •

Order online: www.Limora.com • www.scparts.co.uk

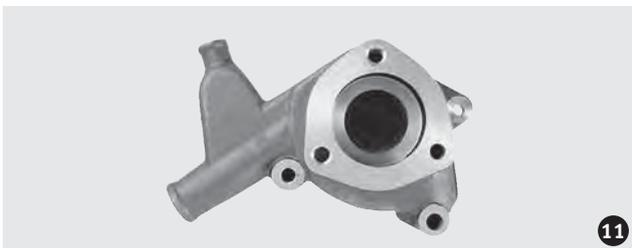
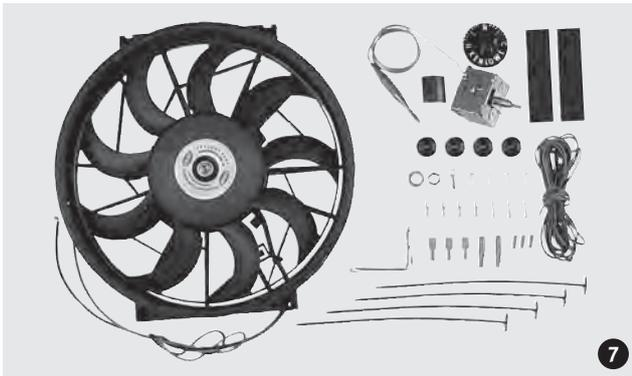
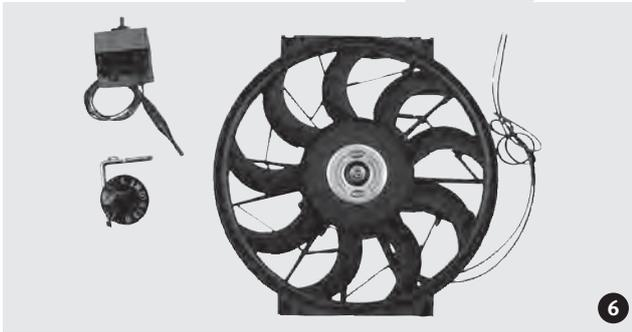

- 6 Kenlowe Electric fan fitted between grille and radiator. These fans are classed as secondary cooling and will probably prove to be adequate, but may be used with genuine fan.
 Technical data: Single fan, diameter 255 mm, installation depth: 46 mm, air flow rate: 1210 m³/h TR2 to TR4A
290010 Without thermostatic switch
15197 With thermostatic switch

- 7 Kenlowe Electric fan fitted between radiator and engine. This fan is recommended as a primary cooling source and requires removal of the original fan and fan extension.
 Technical data: Single fan, diameter 320 mm, installation depth: 66 mm, air flow rate: 3126 m³/h TR2 to TR4A
301248 With thermostatic switch
 Please find single Kenlowe components for individual conversion below

- 8 **202250** Kenlowe Thermostatic switch with sender
 no ill. **12193** Kenlowe Gasket for thermostatic switch sender 202250 (ill. 8)

- 9 **4734** Kenlowe Thermo fan switch kit complete with warning light and fitting kit

- 10 Conversion kit to narrow fan belt
15523 Variant without crankshaft balancer containing 3 pulleys and 1 fan belt. This conversion runs with the original fan, an electric fan is not necessary
479632 Variant with crankshaft balancer containing 3 pulleys and 1 fan belt. This conversion runs only with an electric fan. The original fan has to be replaced
 no ill. **17791** Replacement fan belt for narrow fan belt conversions 15523 and 479632

- 11 **324529** Water pump housing - made from aluminium weight only 0.9 kg

- 12 **471110** Water pump - made from aluminium this lightweight version is a direct replacement for the existing pump but with re-designed impeller to give higher volumes of flow. The improved flow and increased water pressure ensures that all parts of the cooling system receive adequate distribution of water. This pump comes without pulley and is recommended to be fitted in conjunction with our narrow fan belt conversion kit 15523 (ill. 10).
 Weight only 0.7 kg



13

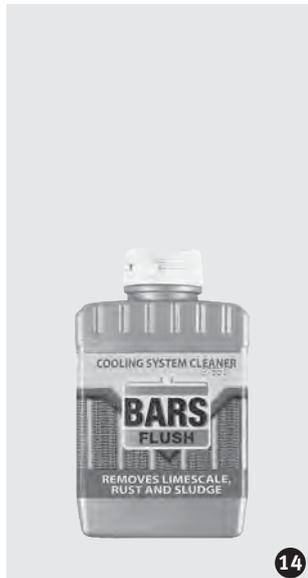

14



15

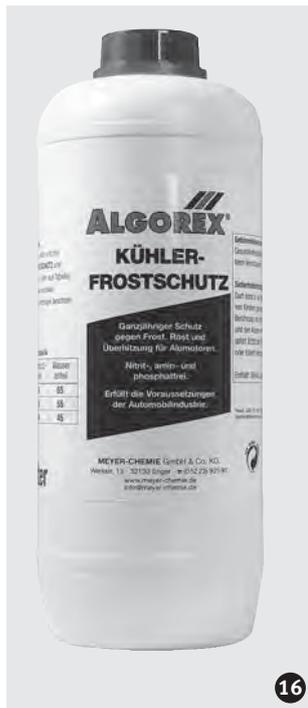

16

- 13 Redline Water Wetter super coolant doubles the wetting ability of water. Improves heat transfer. Reduces cylinder head temperature. Reduces rust, corrosion and electrolysis. Cleans and lubricates water pump seals can be used with all antifreeze/coolants. Improves the ability of coolant to wet heat transfer surfaces by 50%. This provides significantly better coolant contact in the cylinder head and can reduce coolant and head temperature by as much as 65°F. Can be used with 100% water in racing but does not protect magnesium or alter freezing point.
303509 355 ml bottle
- 14 **305787** Bars flush cleans and conditions the cooling system
100 g bottle
- 15 **22884** Penrite Rust-preventive for the cooling system
1 litre bottle
- 16 Anti-freeze coolant for radiator this anti-freeze coolant provides all-year-round protection for your engine against frost, rust and over-heating. Also suitable for alloy engines.
373200 1 litre bottle
314878 1.5 litre bottle
315178 5 litre canister

4 Catalogues, you must have: f.o.c.

- Accessories
- Tuning and more



- Tools •
- Oils and lubricants •

Order online: www.Limora.com • www.scparts.co.uk

21.6

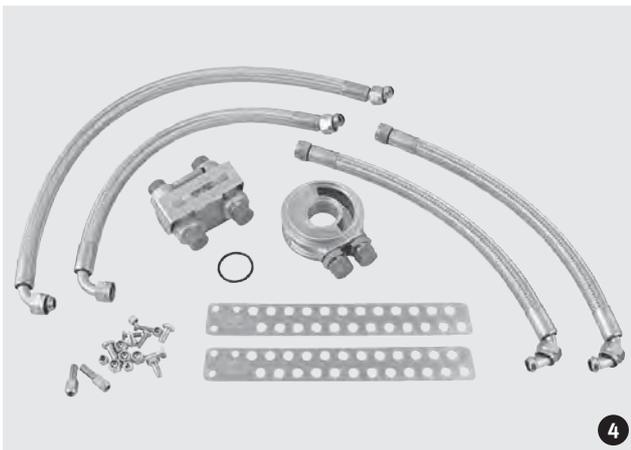
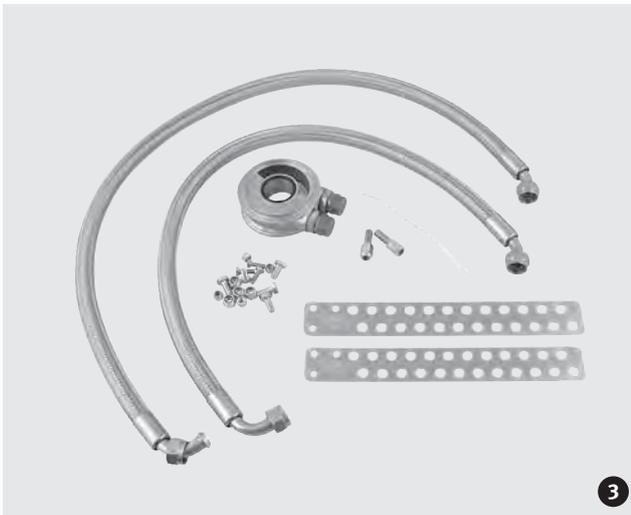
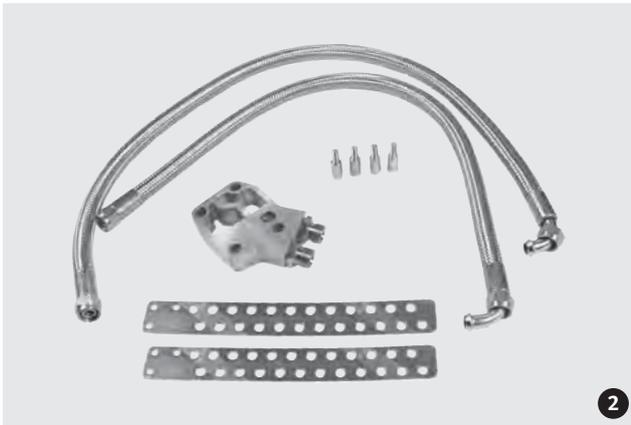
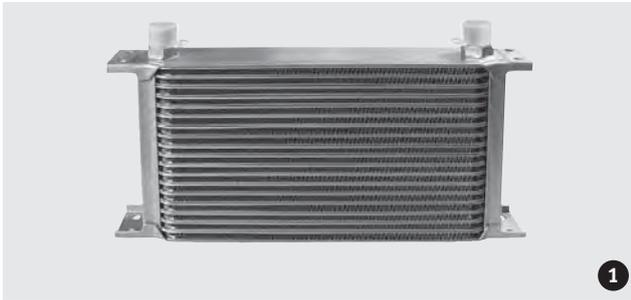

1 Oil cooler with 1/2" unions

Our oil coolers are designed to provide the means by which oils of varying viscosities may be cooled by a flow of air at ambient temperature. Any vehicle using higher rpm than envisaged by the manufacturer needs an oil cooler. The oil cooling requirement of an engine increases threefold for every 1000 rpm increase. Oil, when heated, starts to lose film strength, i.e. the ability to keep metallic surfaces from touching, when the film strength is insufficient to withstand the load, seizure and bearing failure take place. Following sizes are available.

9483 10 rows, sizes: 33 x 8 x 5.5 cm

6341 13 rows, sizes: 33 x 10 x 5.5 cm

300147 16 rows, sizes: 33 x 13 x 5.5 cm

307372 19 rows, sizes: 33 x 15 x 5.5 cm

2 Oil cooler fitting kit, for use with the original filter head

TR2, TR3, TR3A, TR3B and TR4 (identify by square adaptor plate)

327412 With rubber hoses and all needed fittings

13584 With steel braided hoses and all needed fittings

3 Oil cooler fitting kit, for use with the original filter head

TR4A (identify by round adaptor plate)

12205 With rubber hoses and all needed fittings

13587 With steel braided hoses and all needed fittings

4 Oil cooler fitting kit, for use with the original filter head.

Thermostatic controlled

TR2 to TR4A

13588 With rubber hoses and all needed fittings

14382 With steel braided hoses and all needed fittings

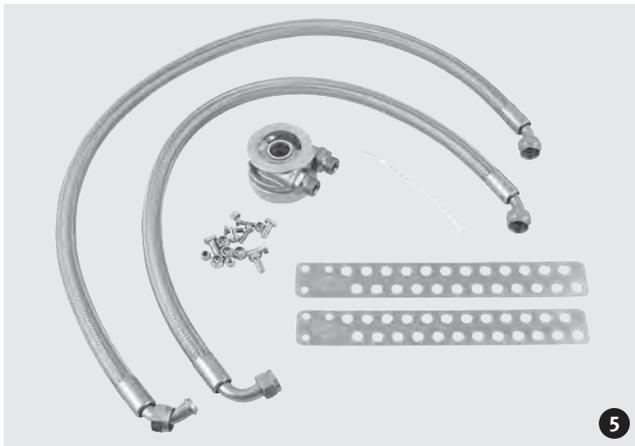

- 5 Oil cooler fitting kit, comes with adaptor for spin on conversion
TR2 to TR4A
319659 With rubber hoses and all needed fittings
319656 With steel braided hoses and all needed fittings

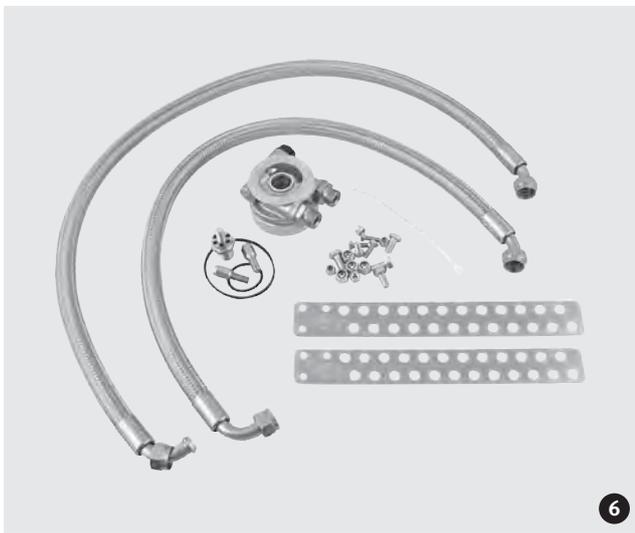

- 6 Oil cooler fitting kit, comes with adaptor for spin on conversion. Thermostatic controlled
TR2 to TR4A
319660 With rubber hoses and all needed fittings
319655 With steel braided hoses and all needed fittings

- 7 **18198** Oil filter for spin on conversions (ill.'s 5 and 6)
- 8 FilterMAG
FilterMAG's powerful rare-earth magnets trap and hold wear-inducing metal particles smaller than 40 microns down to 1 micron that the filter cannot stop. It extends oil life and reduces maintenance costs. Easy fitting while magnetic force „snaps“ FilterMAG to the filter canister. FilterMAG has a lifetime warranty.

- 481133** Standard type
for oil filters from 2.90" to 3.40" diameter,
height 2.0"
- 481135** High performance type
for oil filters from 2.90" to 3.40" diameter,
height 2.625"

- 9 **14275** Oil stat with 1/2" unions
- 10 **13441** Oil stat with push on fittings



21.7



1



2



3



4



5

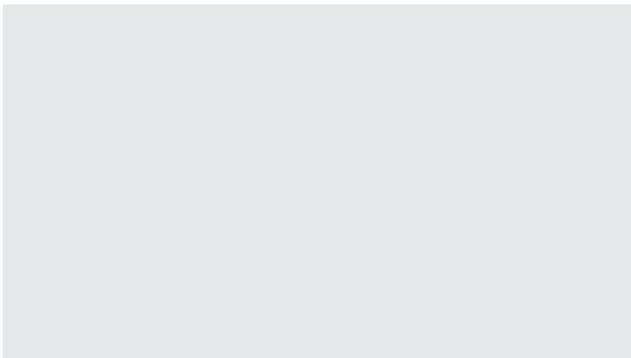

- 1 **300847** Fuel tank - aluminium
Identify by outlet in bottom centre. Needs modification of fuel lines when fitted to TR3A from TS60001 onwards
TR2, TR3, TR3A and TR3B
- 2 **19261** Fuel tank - aluminium
Needs modification on boot floor when fitted to TR4 models
TR4 and TR4A
- 3 **14976** Mitsuba Fuel pump - the one and only!
Dual polarity. Minimum flow approx. 90 litre per hour. Fuel pressure 0.3 bar. Dimensions: 20 x 6 cm.
Mitsuba is one of the leading Japanese manufacturer of electronic fuel pumps. Mitsuba pumps are frequently used in rally and race vehicles. In our opinion, the definitely best and most reliable fuel pump. Suitable for all carburettor engines.
- no ill. **212850** Replacement filter for Mitsuba for fuel pump 14976
- 4 Facet Fuel pump -complete with fitting kit
12 volts interruptor type
 - 15353** Minimum flow rate: 81 litre per hour
fuel pressure: 0,27 to 0.31 bar
 - 304847** Minimum flow rate: 121 litre per hour
fuel pressure: 0.34 to 0.41 bar
 - 12287** Minimum flow rate: 159 litre per hour
fuel pressure: 0.41 bis 0.55 bar
- 5 **8609** Blanking plate for fuel pump hole in cylinder block. You will need this blanking plate when you are replacing the mechanical pump with a high pressure electric unit
- no ill. **8602** Gasket for blanking plate 8609



- 6 **Filter King Fuel pressure regulator**
The ideal way to control the flow and pressure of the fuel delivered to the carburettor
343001 67 mm specification with glass body
15395 85 mm specification with glass body
no ill. **355497** Replacement filter for 67 mm fuel regulator 343001
no ill. **327900** Replacement filter for 85 mm fuel regulator 15395
- 7 **315876** Fuel filter - chrome plated for 5/16" fuel hose
- 8 **316736** Press cap for (5/16") fuel hose
- 9 **316733** Fuel hose - 5/16" braided with zinc plated wire, supplied per metre

**4 Catalogues, you must have:
f.o.c.**

- Accessories
- Tuning and more



- Tools •
- Oils and lubricants •

Order online: www.Limora.com • www.scparts.co.uk

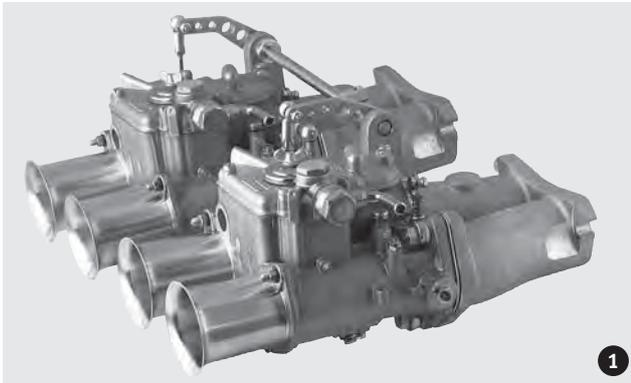

1



2

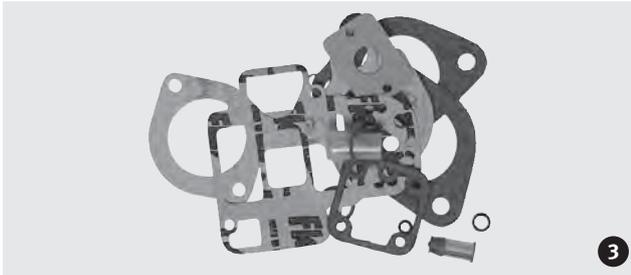

3



4



5



6

- 1 Power has a new name: Weber.
If you are looking for a simple and effective bolt-on performance part, you won't get around these. Weber carburetors provide more power, more torque, better response and a beautiful sound. Please note: Genuine Weber carburetors are cast with the WEBER logo and are stamped „Made in Spain“.
Complete kit comprising two carburetors, inlet manifolds, linkage and all fittings
TR3 from TS9350, TR3A, TR3B, TR4, TR4A
338681 With Weber 40 DCOE carburetors
320961 With Weber 45 DCOE carburetors

- Please find single Weber components for individual conversion below
- no ill. **20393** Weber Carburettor - 40 DCOE type fitted with standard jets
 - no ill. **204940** Weber Carburettor - 45 DCOE type fitted with standard jets
 - no ill. **487085** Throttle linkage for twin Weber DCOE carburetors. Can be used with the standard rod operated linkage
 - no ill. **16979** Inlet manifold for twin Weber DCOE carburettor conversion, 120 mm deep. Designed for LHD cars, but can also be fitted to all RHD vehicles. Supplied in pairs
 - no ill. **12981** Seal plate Weber DCOE carburettor to inlet manifold
 - 2 **17047** Fuel hose kit for twin Weber DCOE carburetors aeroquip type
 - 3 Rebuilt kit - Weber carburettor
336204 40 DCOE type
204941 45 DCOE type
 - 4 **17935** SU Carburetors - HS6 type new items to fit standard inlet manifold. Replacement for Zenith Stromberg carburetors, ready to bolt on TR4A
 - no ill. **487435** Throttle and choke linkage for SU-HS6 conversion
 - 5 **212128** Carburettor damper oil for post 1950 vehicles with SU and Zenith Stromberg carburetors. 125 ml bottle
 - 6 **316230** SU Carburettor cleaner 500 ml aerosol



7



8



9



10



11

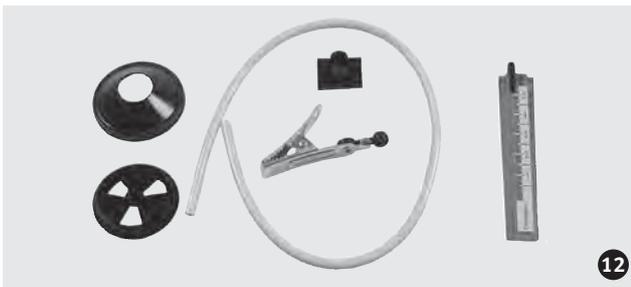

12



13

- 7 Hand reamer for 5/16" throttle spindles
323998 With standard size. Lengths: 115 mm
23031 With 0.010" oversize. Lengths: 235 mm
- 8 Grose jet - superior replacement of needle valve and seat
19687 For SU carburetors
19686 For Zenith Stromberg carburetors
- 9 **20661** Tool kit for SU carburetors
 three-piece including jet linkage spanner
- 10 **19067** Adjusting tool
 for idle mixture screw on Zenith Stromberg carburetors
- 11 **19729** Carburettor balancer
 for SU and Zenith Stromberg carburetors - alloy die cast type
- 12 **25749** Gunson's Carburettor balancer
 for SU and Zenith Stromberg carburetors - plastic type
- 13 **343265** Gunson's Gas tester
 digital exhaust CO analyser with pulse pump

4 Catalogues, you must have: f.o.c.

- Accessories
- Tuning and more



Tools •
Oils and lubricants •

Order online: www.Limora.com • www.scparts.co.uk



1



2



3



4



5

- 1 SU Air filter
 - 215270** For SU-H4 carburetors
round, centre type, 45 mm deep, chromed
TR2
 - 215269** For SU-H6 and SU-HS6 carburetors
round, centre type, 45 mm deep, chromed
TR3, TR3A, TR3B, TR4 and TR4A
- 2 Speedograph Air filter
 - 2705** For SU-H4 carburetors
round, offset type, 25 mm deep, chromed
TR2
 - 2708** For SU-H6, SU-HS6 and Zenith Stromberg 175 CD
carburetors
round, centre type, 25 mm deep, chromed
TR3, TR3A, TR3B, TR4 and TR4A
- 3 Speedograph Air filter
 - 14254** For Weber 40 DCOE carburetors
43 mm deep, chromed
 - 12111** For Weber 45 DCOE carburetors
43 mm deep, chromed

K&N Air filters

probably the most efficient way of ensuring clean, dirt free air for the engine without compromising performance. All filters are constructed with ultra-strong molded pliable rubber flanges which absorb vibration and allow for secure attachment and can also be stretched for up to 1/16" to fit in-between sizes. K&N filters are washable, long life filters.

- 4 K&N Air filter
 - 14357** For SU-H4 carburetors
round, offset type, 45 mm deep
TR2
 - 311563** For SU-H6 and SU-HS6 carburetors
round, offset type, 45 mm deep
TR3, TR3A, TR3B and TR4
 - 4813** For SU-H6, SU-HS6 and Zenith Stromberg
carburetors
round, centre type, 45 mm deep
TR4 and TR4A
 - 311578** For SU-H6, SU-HS6 and Zenith Stromberg
carburetors
round, centre type, 63 mm deep
TR4 and TR4A
- 5 K&N Air filter for Weber 40 and 45 DCOE carburetors
 - 4817** 45 mm deep. For 16 mm ram pipes
 - 22650** 70 mm deep. For 16 mm ram pipes
 - 215251** 83 mm deep. For 26/39 mms ram pipes



6

- 6 **316850** K&N Air filter for Weber 45 DCOE carburetors tapered, 76 mm deep. Two per carburettor needed

K&N Air filter cleaner
the only cleaner formulated to clean K&N filtercharger elements. The use of other cleaning liquids can result in damaging the cotton material of the air filter and therefore the guarantee expires. K&N air filter cleaners are diminishable biologically and do not harm alloy, chrome, rubber, plastic and lacquer to. K&N filters can be washed out up to 25 times before they need to be replaced.

- 7 **4820** 330 ml pump spray
- 8 **319259** 1 litre bottle

K&N air filter oil
is the only oil specially formulated to work in combination with the cotton fabric in K&N filtercharger elements providing a superior air filtration system. When used as directed, it quickly penetrates the filter pleats, where it remains suspended in the cotton fabric. Saturation is maintained until the element is cleaned with K&N air filter cleaner.

- 9 **214887** 20 ml sachet (enough for 2 filters)
- 10 **12353** 237 ml bottle
- 11 **311572** 400 ml aerosol



7



8



9



10



11

**4 Catalogues, you must have:
f.o.c.**

- Accessories
- Tuning and more



- Tools •
- Oils and lubricants •

Order online: www.Limora.com • www.scparts.co.uk

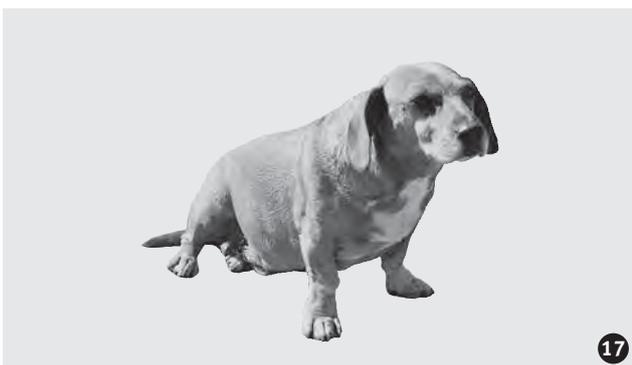

- 12 Ram pipe
for SU-H4 carburetors, alloy, no gauze
TR2
356204 1.4" deep
26522 2.8" deep
- 13 Ram pipe
for SU-H4 carburetors, alloy, with gauze
TR2
216075 1.5" deep
344130 2.9" deep
- 14 Ram pipe
for SU-H6 and SU-HS6 carburetors, alloy, no gauze. Needs
modification to use on Zenith Stromberg carburetors
TR3, TR3A, TR3B, TR4 und TR4A
294256 1.4" deep
356195 2.75" deep
- 15 Ram pipe
for SU-H6 and SU-HS6 carburetors, alloy, with gauze. Needs
modification to use on Zenith Stromberg carburetors
TR3, TR3A, TR3B, TR4 und TR4A
206481 1.5" deep
356200 2.95" deep
- 16 K&N crank case breather
size: diameter: 51 mms, height: 38 mm
317467 With external inlet pipe for 1/2" hose
210700 With external inlet pipe for 5/8" hose
- 17 **0815** Stups
only restricted quantity available

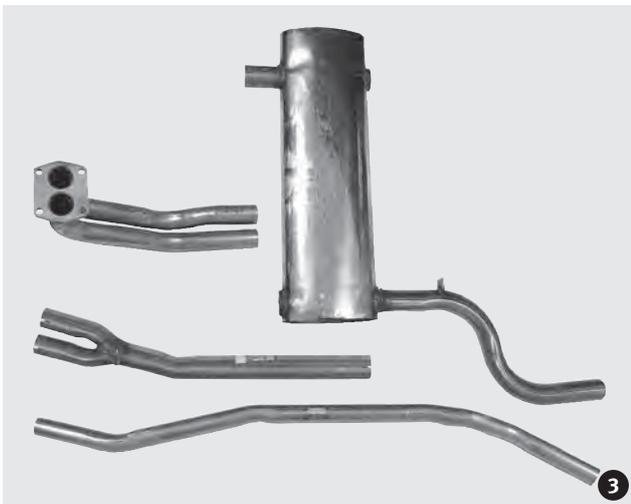
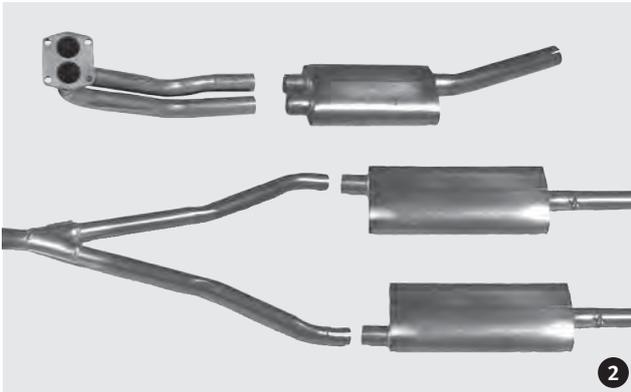
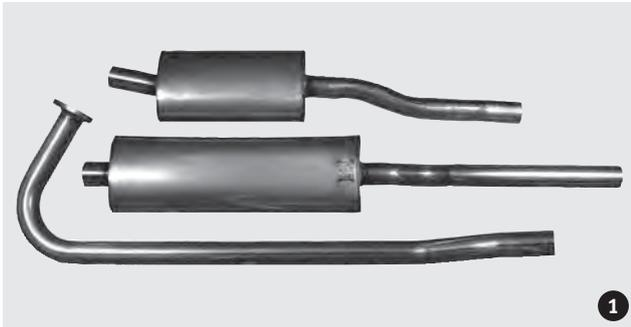

- 1 **928** Exhaust system - stainless steel TR2 to TR4
- 2 **1916** Exhaust system - stainless steel twin box type TR4A to approx. CTC70000
- 3 **1917** Exhaust system - stainless steel single cross box type TR4A from approx. CTC70001

4 Catalogues, you must have:
f.o.c.

- Accessories
- Tuning and more



- Tools •
- Oils and lubricants •

Order online: www.Limora.com • www.scparts.co.uk

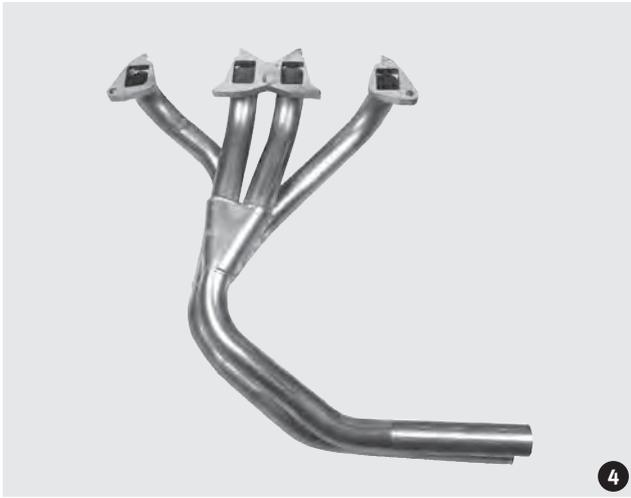

- 4 Tubular manifold
TR3A from TS50001, TR3B, TR4 and TR4A
(cars fitted with ,long type' starter motor. Could also be fitted to earlier cars when using a high torque starter motor).
326262 Stainless steel
4526 Mild steel



- 5 Stainless steel pipes - connecting exhaust with tubular manifold - TR2 to TR4
337393 ,Y' exhaust pipe - manifold to adaptor pipe
342059 Adaptor pipe - ,Y' pipe to exhaust system



- 6 Stainless steel pipe - connecting exhaust with tubular manifold - TR4A
2637 ,Y' pipe - tubular manifold to exhaust system



- 7 Exhaust system - stainless steel
2" big bore type with single silencer. This exhaust will link to our tubular manifolds 326262 and 4526 (ill. 4)
13010 TR2 to TR4
13012 TR4A

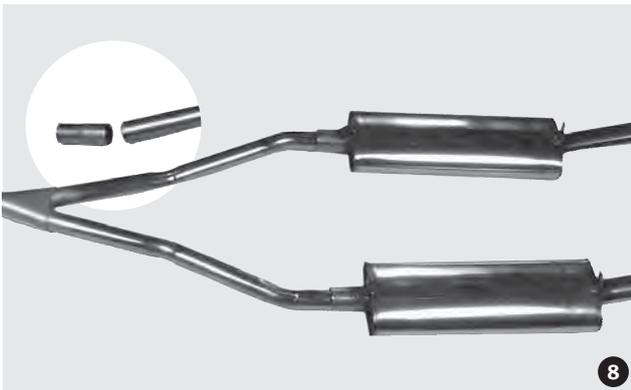

- 8 **15533** Exhaust system - stainless steel
1.7/8" sports type with twin rear silencers. This exhaust will link to our tubular manifolds 326262 and 4526 (ill. 4)
TR4A

21.10

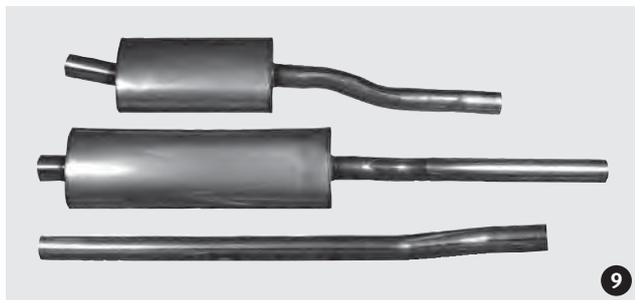

9



10

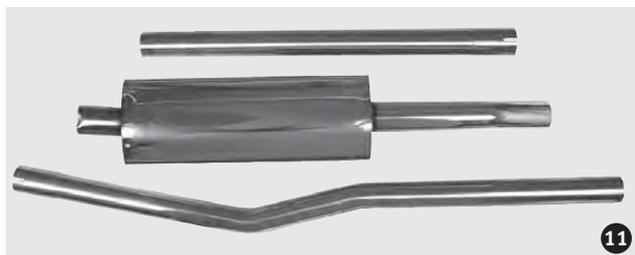

11

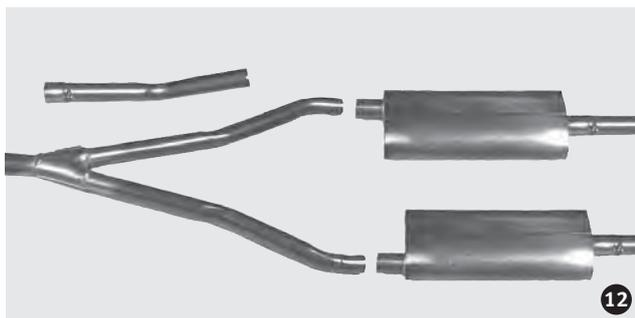

12



13



14



15

Phoenix Performance Exhausts

no price compromise on quality. Their craftsmen use the industry's most sophisticated pipe bending technology to produce perfect mandrel bends to promote optimum exhaust gas flow performance. All systems are manufactured from the finest 304 Grade stainless steel throughout their construction, including the internal baffle plates.

- 9 **298057** Phoenix Exhaust system - stainless steel
3 piece kit with standard diameter but without down pipe. Could be fitted to our tubular manifolds 296611 or 326262 (ill. 10) when using adaptor pipe 298058 TR2 to TR4
- no ill. **298058** Phoenix Adaptor pipe - stainless steel
allows to adapt the above exhaust system to a tubular manifold 296611 or 323526 (ill. 10) TR2 to TR4
- 10 Phoenix Tubular manifold - stainless steel
4-in-2-in-1 type with 2" big bore diameter
296611 TR2 from TS13052, TR3, TR3A to TS50000 (cars fitted with ,bomb type' starter motor)
323526 TR3A from TS50001, TR3B, TR4 and TR4A (cars fitted with ,long type' starter motor. Could also be fitted to earlier cars when using a high torque starter motor)
- 11 Phoenix Exhaust system - stainless steel
2" big bore type with single silencer. This exhaust will link to our tubular manifolds 296611 and 323526 (ill. 10)
13011 TR2 to TR4
296126 TR4A
- 12 **296291** Phoenix Exhaust system - stainless steel
2" big bore type with twin silencer. This exhaust will link to our tubular manifold 323526 (ill. 10) TR4A
- 13 Exhaust mounting kits
20760 TR3 from TS11717, TR3A and TR3B. Must be modified when using on earlier models
20761 TR4
20762 TR4A to approx. CT70000 (cars fitted with twin box exhaust)
20763 TR4A from approx. CT70001 (cars fitted with single cross box exhaust)
- 14 **317127** Exhaust thermal wrap
roll with 10 meter - 50 mm wide, 2 mm thick. Heat resistant to 1000° C
- 15 **485440** Luster Lace Polishing strips ,Combo' complete assortment, for exhaust systems and tubular manifolds. Content: 4 strips 1/2" wide, 3 strips 3/4" wide and 2 strips 1.1/4" wide

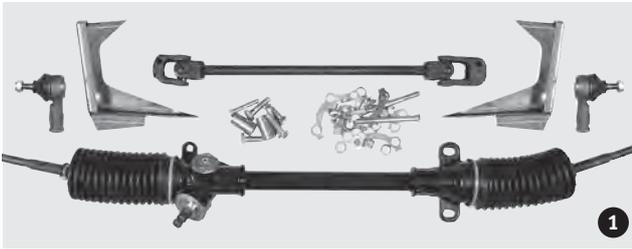

1

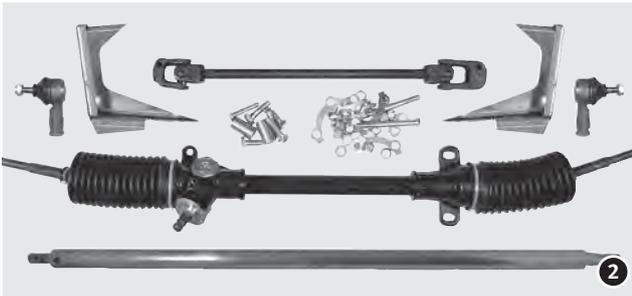

2



3



4

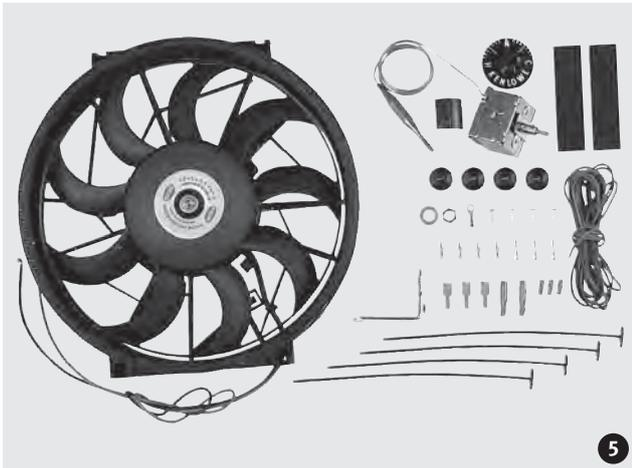

5

Steering rack conversion kit including modified steering arms. Your original steering arms need to be returned to us for credit as they are supplied on an exchange basis

- 1 TR2, TR3, TR3A and TR3B - vehicles with split steering column
6634 LHD cars
329330 RHD cars
- 2 TR2, TR3, TR3A and TR3B - vehicles with rigid steering column
294686 LHD cars
338812 RHD cars

Please find further components for steering rack conversion below

TR2, TR3, TR3A and TR3B

- 3 Support kit to bolt steering rack conversion kit to bulkhead
338040 LHD cars
338039 RHD cars
 - 4 **478480** Fan blade with fitting kit may replace original fan
 - 5 **301248** Kenlowe Electric fan with thermostatic switch technical data: single fan, diameter 320 mm, installation depth: 66 mm, air flow rate: 3126 m³/h. Fitted between radiator and engine. This fan is recommended as a primary cooling source and can be used as an alternative to our fan conversion 478480 (ill. 3)
- no ill. **3491** Contact mechanism for original control head when fitting a steering rack conversion kit

4 Catalogues, you must have: f.o.c.

- Accessories
- Tuning and more



- Tools •
- Oils and lubricants •

Order online: www.Limora.com • www.scparts.co.uk



6



7

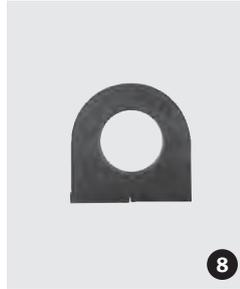

8



9



10

6 Steering rack high ratio type (2.1/2 turns from lock to lock). Mounted with rubber bushes to chassis

314953 LHD cars - TR4 from CT20064, all TR4A

314954 RHD cars - TR4 from CT20266, all TR4A

7 **347706** Tie rod end - reinforced type TR4 und TR4A

8 Polyurethane bushes

Polyurethane bushes give improved suspension location with a greater wear resistance compared to their rubber equivalents. They are naturally self-lubricating. A worthwhile addition to any car, the polyethylene bushes are supplied individually, with a steel sleeve where necessary.

25799 Polyurethane bush - steering rack mounting replacement for rubber mountings

TR4 RHD from CT20266, TR4 LHD from CT20064, all TR4A

9 **17053** Fitting kit - steering rack uprated aluminium version. Replacement for rubber mountings

TR4 RHD from CT20266, TR4 LHD from CT20064, all TR4A

10 **343863** Bush - steering column manufactured from modern nylon bearing material which can operate with much closer tolerances than the original bush could TR4 and TR4A



1



2



3



4

- 1 Moto-Lita Mark 3 woodrim wheels
hand finished laminated marine timber rims with 3 polished spokes with holes and visible rivets. Only original with the „Moto-Lita“ logo.
4637 13“ flat
4636 13“ dished
4635 14“ flat
4634 14“ dished
4943 15“ flat
4633 15“ dished
337063 16“ flat
337064 16“ dished
- 2 Moto-Lita Mark 3 woodrim wheels
hand finished laminated marine timber rims with 3 polished spokes with slots and visible rivets. Only original with the „Moto-Lita“ logo.
303130 13“ flat
276612 13“ dished
326559 14“ flat
323406 14“ dished
313431 15“ flat
313432 15“ dished
- 3 Moto-Lita Classic 3 spoke woodrim wheels
hand finished laminated marine timber rims with 3 polished spokes with slots and visible rivets. Only original with the „Moto-Lita“ logo.
318372 15“ flat
- 4 Moto-Lita Mark 10 woodrim wheels
hand finished laminated marine timber rims with 3 polished spokes and visible rivets. Only original with the „Moto-Lita“ logo.
329343 15“ flat
337070 15“ dished



5



6



7



8

- 5 Moto-Lita Classic 4 spoke woodrim wheels
hand finished laminated marine timber rims with 4 polished spokes and visible rivets. Only original with the „Moto-Lita“ logo.
337067 14“ flat
318370 15“ flat
337068 16“ flat
- 6 Moto-Lita Classic 4 spoke woodrim wheels
hand finished mahogany and walnut timber rims with 4 polished spokes. No visible alloy steering ring and rivets. Only original with the „Moto-Lita“ logo.
318553 15“ flat
206798 15“ flat
- 7 Moto-Lita Mark 9 Woodrim wheels in traditional style
hand finished mahogany and walnut timber rims and 3 polished heavy gauge aluminium alloy spokes with holes. No visible alloy steering ring and rivets. Only original with the „Moto-Lita“ logo.
321867 14“ flat, mahogany
326298 14“ dished, mahogany
325594 15“ flat, mahogany
302955 15“ dished, mahogany
337071 14“ flat, walnut
337074 14“ dished, walnut
337072 15“ flat, walnut
337073 15“ dished, walnut
- 8 Moto-Lita Mark 9 Woodrim wheels in traditional style
hand finished mahogany and walnut timber rims and 3 polished heavy gauge aluminium alloy spokes with slots. No visible alloy steering ring and rivets. Only original with the „Moto-Lita“ logo.
337079 14“ flat, mahogany
337080 14“ dished, mahogany
318201 15“ flat, mahogany
21222 15“ dished, mahogany
337077 14“ flat, walnut
337076 14“ dished, walnut
337078 15“ flat, walnut
337075 15“ dished, walnut

21.13



1



2



3



4

Moto-Lita Mark 4 leather rim steering wheels with 3 spokes, available in four variants. First selection black cowhide, handsewn over rubber handgrip. Heavy gauge aluminium alloy spokes.

- 1 Polished spokes with holes
 - 4618 13" flat
 - 4624 13" dished
 - 4626 14" flat
 - 4628 14" dished
 - 4630 15" flat
 - 4632 15" dished
- 2 Polished spokes with oval slots
 - 348394 13" flat
 - 348398 13" dished
 - 348395 14" flat
 - 348399 14" dished
 - 348396 15" flat
 - 348400 15" dished
- 3 Polished spokes
 - 306738 12" flat
 - 306739 12" dished
- 4 Black coloured spokes with holes
 - 4619 13" flat
 - 4623 13" dished
 - 4625 14" flat
 - 4627 14" dished
 - 4629 15" flat
 - 4631 15" dished

4 Catalogues, you must have:
f.o.c.

- Accessories
- Tuning and more



Tools •
Oils and lubricants •

Order online: www.Limora.com • www.scparts.co.uk

21.14



1



2



3



4



5

- 1 **318640** Moto-Lita Boss kit supplied without centre cap. This boss will accept the original control head TR2, TR3, TR3A and TR3B - cars fitted with adjustable steering wheel
- 2 **21664** Moto-Lita Boss kit supplied without centre cap. This boss will accept the original control head TR2, TR3, TR3A and TR3B - cars fitted with non-adjustable steering wheel
- 3 **4946** Moto-Lita Boss kit supplied with horn push for conversion to indicator switch TR2, TR3, TR3A and TR3B - cars fitted with adjustable steering wheel
- 4 **4947** Moto-Lita Boss kit supplied with horn push for conversion to indicator switch TR2, TR3, TR3A and TR3B - cars fitted with non-adjustable steering wheel
- 5 **4944** Moto-Lita Boss kit without horn control TR4 and TR4A



6



7



8



9



10



11



12



13

Please find single Moto-Lita components for individual conversion below

- 6 **307427** Moto-Lita Centre cap for steering wheel boss, black
- 7 **326172** Moto-Lita Horn push for steering wheel boss, black plastic
- 8 Moto-Lita Retaining ring for steering wheel including screw kit
322655 polished
323440 black

no ill. **347826** Moto-Lita Screw kit for steering wheel retaining chromed

- 9 Moto-Lita Centre cap for boss kit made from polished alloy
219954 3.5" diameter, screws and rings are visible
205326 4.0" diameter, screws and rings are not visible

Self adhesive badges for steering wheel boss

- 10 **326442** With 'Triumph' shield logo
- 11 **480813** With 'Triumph' laurel logo
- 12 **327883** With 'Union Jack'
- 13 **469570** With crossed chequered flags

21.15



1



2

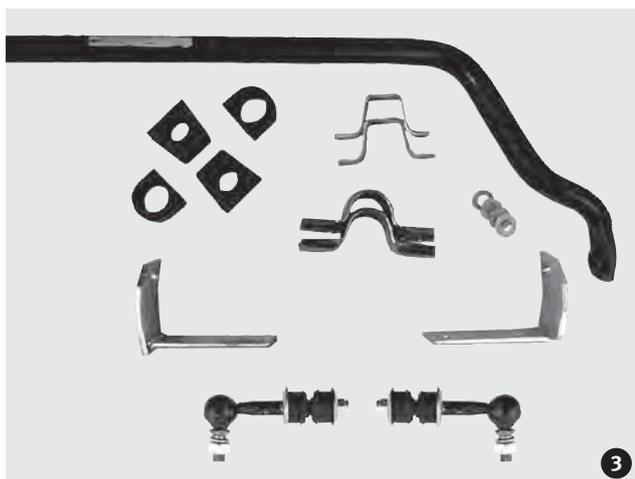

3



4



5

1 Gaz shock absorbers

a real leap forward in performance suspension. A new range of fully adjustable competition and fast road shock absorbers and suspension kits for the discerning driver.

Flexibility: Easy 36 point rotary adjustment providing the facility for fine tuning without the need to remove the shock absorber from the car. Revolutionary: Double lip seal plus a further stem seal on the piston rod. Produces a shock absorber with unrivalled performance characteristics for both the road and track. Drivability: Employing our complete understanding of every aspect of damping technology we believe that Gaz shock absorbers strike the ultimate balance between comfort and performance road holding. Reliability: Every unit is fully tested and dispatched from our factory with an individual dynamometer report. Quality: Made to accredited ISO9002 standard and supplied with a 3 year warranty. Durability: Zinc plated body that resists salt spray and road grime on vehicles where detailing really matters. Availability: A full range of full adjustable shock absorbers and suspension kits for popular models.

342047 TR2, TR3, TR3A, TR3B and TR4

342049 TR4A

2 Koni shock absorbers

the Koni Classic line makes modern shock absorber technology available for classic cars and cars from the '50s, '60s, '70s and '80s. This range makes our extensive know-how and experience of improving handling and road holding available to owners of classic cars. Classic shock absorbers have the same superior qualities which the red Koni Special and the yellow Koni Sport shock absorbers offer to modern cars. Your classic car will run so smoothly that you won't recognise it. Koni Classic shock absorbers are finished with the traditional black gloss and wing logo used for the very first Koni shock absorbers. Koni Classic provides a unique combination of modern technology combined with traditional looks.

Koni's are adjustable, which means that you can influence the behaviour of the car to meet your preferences. It also means that wear can be compensated (however, you will probably never need it). Last but not least; Koni's are built to last a lifetime. Once you bought a set of Koni's for your car, the usually will outlive it.

213154 TR2, TR3, TR3A, TR3B and TR4

12998 TR4A

3 Anti roll bar

including fitting kit - uprated 3/4" version

12562 TR2, TR3, TR3A and TR3B

4507 TR4

4506 TR4A

4 Hub - made from alloy

TR3 from TS130046, TR3A and TR4

325990 With standard flange

337461 With extra thick flange for better adjustment

5 Wheel stud

TR3 from TS130046, TR3A, TR3B, TR4 and TR4A

196 With 1.1/2" standard length - cars with disc wheels

342039 Longer version with 1.21/32"

may replace original wheel studs when fitting alloy wheels, using wheel spacers or to obtain more thread contact on competition cars

478468 Longer version with 2.11/64"

may replace original wheel studs when fitting alloy wheels, using wheel spacers or to obtain more thread contact on competition cars



6



7



8



9

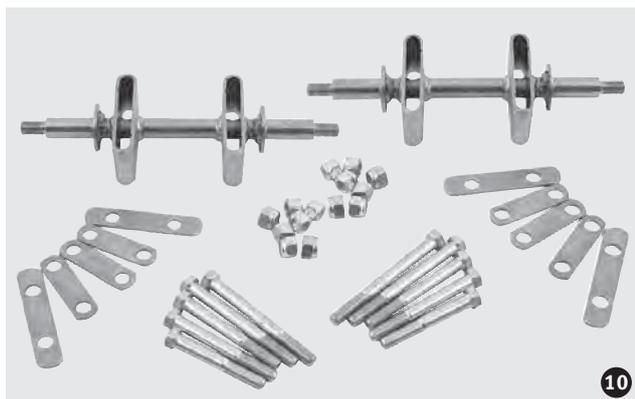

10

- 6 Polyurethane bushes give improved suspension location with a greater wear resistance compared to their rubber equivalents. They are naturally self-lubricating. A worthwhile addition to any car, the polyethylene bushes are supplied individually, with a steel sleeve where necessary.

325767 Front shock absorber lower mounting
TR2 to TR4

25798 Front shock absorber lower mounting. With inner sleeve
TR4A

317093 Front shock absorber upper mounting
TR2 to TR4A

25795 Front lower wishbone, with inner sleeve
TR4A

25794 Front upper wishbone
TR2 to TR4A

25794 Front lower wishbone
TR2, TR3 to TS9120

317871 Front anti roll bar link, with inner sleeve
TR4A

312158 Lubricant for polyurethane bushes, 5 g. tube

- 7 Nylatron bushes are machined from graphite impregnated nylon. They are designed to replace the standard rubber bush, thus helping to stiffen suspension unless you are willing to accept an increase of maintenance, noise and vibration. Recommended for competition, sprint and full race cars.

13527 Front lower wishbone - supplied in sets of 4
TR2 to TR4

25564 Front upper wishbone - supplied in sets of 4
TR2 to TR4

13527 Front upper wishbone - supplied in sets of 4 - TR4A

13529 Front lower inner wishbone - supplied in sets of 4
TR4A

13530 Front lower outer wishbone - supplied in sets of 4
TR4A

317094 Front shock absorber upper mounting - TR4A

12667 Front shock absorber lower mounting - TR4A

- 8 Coil springs

we offer a complete range of competition coil springs from Rally, through Fast Road to Full Race specification. All these springs are designed to be used with the standard 2" coil spring spacer 19115. It may not be needed when fitting these springs to lightweight cars.

1102 Spring rate: 390 lbs/in
fitted length on TR2 to TR4 models: 7.1"
fitted length on TR4A models: 7"

12112 Spring rate: 390 lbs/in
fitted length on TR2 to TR4 models: 6.7"
fitted length on TR4A models: 6.7"

4677 Spring rate: 420 lbs/in
fitted length on TR2 to TR4 models: 7"
fitted length on TR4A models: 7"

4493 Spring rate: 420 lbs/in
fitted length on TR2 to TR4 models: 6.2"
fitted length on TR4A models: 6"

12324 Spring rate: 450 lbs/in
fitted length on TR2 to TR4 models: 6.5"
fitted length on TR4A models: 6.5"

- 9 **19115** Coil spring spacer
made from aluminium. Height: 2"

- 10 **300878** Wishbone fulcrum pin
this useful kit allows an accurate camber setting of the front suspension. Complete set for RH and LH side
TR4 with wire wheels from CT6344, TR4 with disc wheels from CT6391, all TR4A



1



2



3



4



5



6

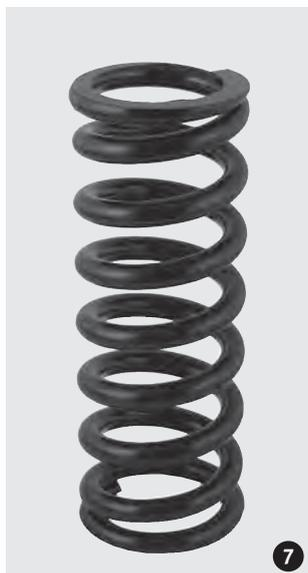

7



8



9



10

- 1 Leaf springs
 - 17408** Lowered by 1" approx
TR2, TR3, TR3A, TR4 up to CT23382
 - 12572** Road/Rally type with increased spring rate
TR2, TR3, TR3A, TR4 up to CT23382
 - 17407** Lowerd race type with increased spring rate
TR2, TR3, TR3A, TR4 up to CT23382
 - 296860** Lowered by 1" approx
TR4 from CT23383
- 2 **313452** Polyurethane bush - leaf spring, rear shackle
TR2 to TR4A with solid rear axle
- 3 **13034** Nylatron bush - leaf spring, rear shackle
TR2 to TR4A with solid rear axle
- 4 Shock absorber - 25% uprated version
TR2 to TR4
 - 479657** LH rear - new item
 - 19186** LH rear - exchange
 - 479658** RH rear - new item
 - 19187** RH rear - exchange
- 5 **25796** Polyurethane bush with inner sleeve
rear trailing arm
TR4A IRS
- 6 **12814** Nylatron bush - rear trailing arm
TR4A IRS
- 7 Coil springs for TR4 IRS
We offer a complete range of competition coil springs from Rally, through Fast Road to Full Race specification. All these springs are designed to be used with the standard 2" coil spring spacer 19115. It may not be needed when fitting these springs to lightweight cars.
 - 1103** Spring rate: 390 lbs/in
fitted length: 9.65"
 - 2765** Spring rate: 420 lbs/in
fitted length: 8.85"
 - 4678** Spring rate: 420 lbs/in
fitted length: 8.5"
 - 4710** Spring rate: 510 lbs/in
fitted length: 8.45"
 - 4679** Spring rate: 550 lbs/in
fitted length: 7.3"
- 8 **19115** Spacer - coil spring
made from aluminium. Height: 2"
TR4A IRS
- 9 **20035** Spacer plate - coil spring
made from nylon. Allows adjustment of the spring
fitted height. Maximum of 2 per spring. Height: 1.20"
TR4A IRS
- 10 **317895** Polyurethane pad - coil spring insulator
TR4A IRS



11

11 Shock absorber - 25% uprated version TR4A

326287 LH rear - new item

20857 LH rear - exchange

326288 RH rear - new item

20858 RH rear - exchange



12

12 **15826** Shock absorber valve - 25% uprated version to fit to your own unit TR4A

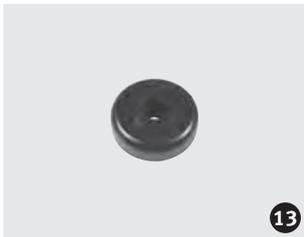

13

13 **317093** Polyurethane bush rear shock absorber connection link to trailing arm TR4A IRS



14

14 Shock absorber conversion brackets rear
The main bracket is bolted to the shock absorber mount and the axle bracket is bolted and then to be welded in position. TR2 and TR3 models need some modification at the main bracket. Available as a set of brackets with instructions.

15528 TR2, TR3, TR3A to TS60000

467185 TR3A from TS60001, TR3B, TR4 and TR4A with solid axle



15

15 **16532** Shock absorber conversion brackets rear
This new developed conversion kit allows the fitment of the dampers to the chassis to improve the ride and suspension. To fit this bracket kit will take a little longer but do strengthen and stiffen the rear of the bodyshell. Available as a set of brackets with instructions.

TR4A IRS

4 Catalogues, you must have: f.o.c.

- Accessories
- Tuning and more



- Tools
- Oils and lubricants

Order online: www.Limora.com • www.scparts.co.uk



16



17



18



19



20



21



22



23

The below listed Koni and Gas telescopic shock absorbers can only be used when the 'old' lever arm shocks have been replaced by one of our conversion kits (ill. 14 and 15)

- 16 Koni Shock absorbers
 - 19012** TR2, TR3 und TR3A
identify by flat spring fitted without alloy spacer
 - 4928** TR4 to CT23382
identify by flat spring fitted without alloy spacer
 - 19012** TR3B, TR4 from CT23383, TR4A with solid axle
identify by deep dished spring fitted with alloy spacer
 - 17042** TR4A IRS
- 17 Gaz Shock absorbers
 - 355178** TR2, TR3 und TR3A
identify by flat spring fitted without alloy spacer
 - 342055** TR4 to CT23382
identify by flat spring fitted without alloy spacer
 - 355178** TR3B, TR4 from CT23383, TR4A with solid axle
identify by deep dished spring fitted with alloy spacer
 - 342050** TR4A IRS
- 18 **17683** Quaiffe Limited slip differential
a direct replacement for the standard differential, the limited slip differential transforms your car's performance. Unlike a conventional plate-style limited slip differential, this differential relies on gears rather than clutch plates for its operation. That means it is much smoother in operation. This differential type never locks harshly with a set pre-load of wheel slip across the driven axle, like a conventional LSD. Rather, the differential automatically biases the torque away from the spinning wheel across the axle, to a constantly varying degree, and never locks.
- 19 Crown wheel and pinion for all TR2 to TR4A models
 - 2463** Ratio: 3.45:1
 - 365** Ratio: 3.70:1
 - 293270** Ratio: 4.33:1
 - 298254** Ratio 4.55:1
 - 10549** Ratio 4.875:1
- 20 Differential cover for TR4A IRS
TR6 variant - may replace original cover and bracket
 - 324536** Made from aluminium
 - 337533** Made from magnesium
- 21 **25792** Polyurethane bush - front upper differential mount TR4A IRS
- 22 **25793** Polyurethane bush - front lower differential mount TR4A IRS
- 23 **25792** Polyurethane bush - rear differential mount TR4A IRS

21.16



24



25

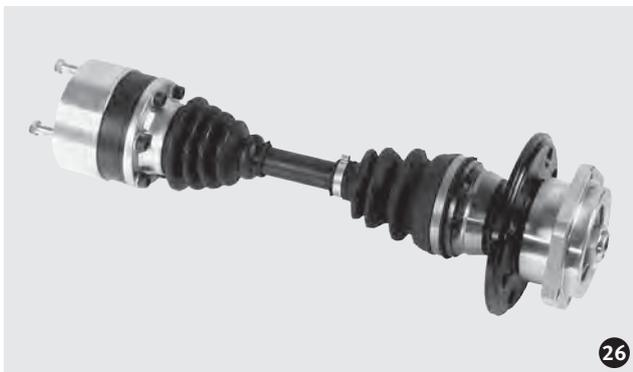

26



27

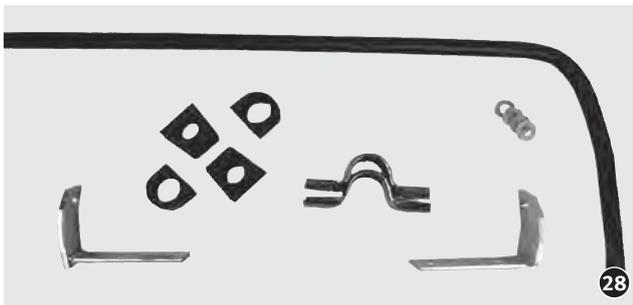

28

- 24 **312158** Lubricant for polyurethane bushes, 5 g. tube
 - 25 **479611** Drive shaft - improved version with flange and universal joint assembly TR4A IRS
 - 26 **323905** Drive shaft - complete with hub unit improved version with constant velocity joints and ball bearing sliding shafts TR4A IRS
- Please find single components for drive shaft conversion 323905 (ill. 26)
- no ill. **480861** Wheel bearing kit TR4A IRS
 - 27 **294556** Puller for rear hub enables quick and safe removal of rear hub flange without damaging the surface
 - 28 Anti roll bar including fitting kit
 - 4505** TR2, TR3, TR3A and TR3B - 5/8" version
 - 4502** TR4 - 5/8" version
 - 4504** TR4A IRS - 3/4" version

4 Catalogues, you must have: f.o.c.

- Accessories
- Tuning and more



- Tools •
- Oils and lubricants •

Order online: www.Limora.com • www.scparts.co.uk

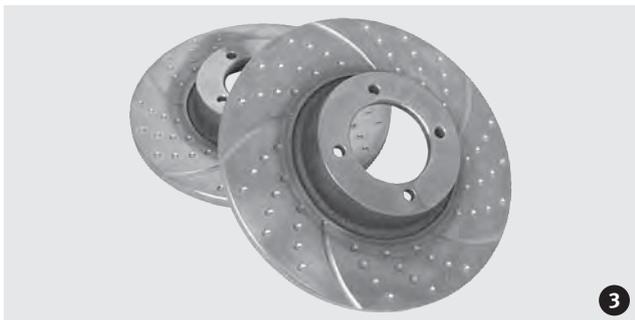

1 Mintex M1144 brake pads
 the Mintex brand is the most famous when it comes to motor-sport. Through intense Research and Development Mintex materials cater not only for Original Equipment and Aftermarket needs but at the other extreme for competition purposes. It is from motorsport that the latest family of Mintex materials have been developed. Known as C-Tech, these materials cover a whole spectrum of vehicles from a typical small hot hatchback for normal day to day use, through to a fully race prepared 700 bhp racing machine.

M1144 is the material for fast road use as well as light competition such as karting, hill climb and single seater racing cars. One of the main characteristics of this material is the ability to work from cold, which gives the user the confidence of a standard material on the first application of the brakes. The benefit of M1144 is experienced as the temperature within the brakes starts to increase. M1144 will remain stable and consistent through to 450° C where a standard material at this temperature will most certainly start to fade. The bedding in procedure for M1144 is the same as any standard material i.e. steady braking for the first 50 miles, avoiding emergency stops. All M1144 pads are supplied with fully branded C-Tech anti noise shims and a C-Tech sticker.

205117 Mintex Brake pads - front
 TR3B TCF series, TR4 with wire wheels from CT4690,
 TR4 with disc wheels from CT4388, all TR4A

2 475036 Brake pads - front
 Kevlar ,green stuff[®] specification
 TR3B TCF series, TR4 with wire wheels from CT4690,
 TR4 with disc wheels from CT4388, all TR4A

3 337602 Brake discs - front
 with curved grooves and spot drillings to maximize
 pad performance - supplied in pairs for standard 2
 pot calipers
 TR3B TCF series, TR4 with wire wheels from CT4690,
 TR4 with disc wheels from CT4388, all TR4A

4 320312 Brake disc - front
 drilled. Suitable for standard 2 pot calipers
 TR3B TCF series, TR4 with wire wheels from CT4690,
 TR4 with disc wheels from CT4388, all TR4A

5 Front brake conversion kit to 4 pot calipers
 contents: competition brake pads, 4 pot calipers, 283 mm ven-
 ted discs, billet machined brackets and all needed fittings.
 TR3 from TS130446, TR3A to TR4A
 Direct replacement for above listed cars, but can also be fitted
 to earlier cars by changing the caliper mounting bracket to the
 later type.

15396 Kit with vented discs
327493 Kit with vented discs with curved grooves and spot
 drillings



6



7



8

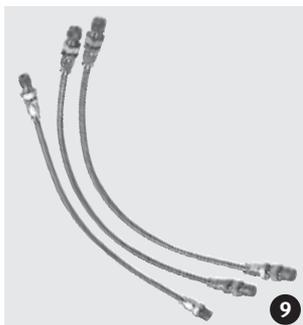

9



10



11

- 6 Backing plate for 4 pot caliper conversions
TR3 from TS130446, TR3A, TR3B TSF series, TR4 with wire wheels to CT4689, TR4 with disc wheels to CT4387

2393 For LH brake caliper

2392 For RH brake caliper

Please find single components for individual 4 pot caliper conversion (ill. 5) below

TR3 from TS130446, TR3A to TR4A

- 7 Brake disc with 283 mm diameter
341777 Vented to maximize pad performance
341778 Vented with curved grooves and spot drillings to maximize pad performance

- 8 Brake pads
322575 Road specification
319940 Fast Road specification
323473 Race specification

- 9 Goodridge Brake hoses - aeroquip type
Goodridge have developed and manufactured hoses for the following high profile applications Formula 1, Thrust 2 (world land speed record holder), Nascar, every major Rally team. Because of their expertise in the hydraulics field they have been able to apply this knowledge to the automotive industry to give replacement brake hoses and fittings that outperform even the original equipment products. Goodridge kits feature the finest quality stainless steel braided hose, which improves braking performance, eliminates the spongy feel of rubber hoses and provides superior resistance to corrosion. Hose end fittings are zinc plated steel as standard or stainless steel as an option. Goodridge manufacture hose for all the major manufacturers including.

295770 Set with 3 lines
TR2, TR3 to TS 13045

312461 Set with 3 lines
TR3 from TS13046, TR3A, TR3B and TR4

325153 Set with 3 lines
TR4A with solid rear axle

343272 Set with 4 lines
TR4A IRS

- 10 **281649** Brake servo with fitting kit
brake pressure: 1.90:1, bore size: 5/8". Suitable for all models with single line braking system

- 11 Rear brake drum
made of aluminium alloy with bonded iron inserts and circumferential fins. These brake drums improve heat dissipation, add to the braking capacity of your car and also reduces the fading. Two needed per car.

3288 ‚A-Fin‘ drum
TR3A from TS56377, TR3B, TR4 and TR4A
(cars with 9" brakes)



1



2



3



4

Wire wheels

over the years, our wire wheels have evolved through the incorporation of new technology and superior materials, changing with the times without compromising the classic style. All our British Classic Wire Wheels are covered by warranty periods of up to three years.

Wire wheel finishes. The rim and shell are polished to superior finish in special purpose machines. The hand polishing by highly skilled craftsmen compliments this. The nickel plating is done by the Dunlop Method, in which a decorative bright nickel layer is plated over a strong inner semi-bright layer of nickel. The surface finish is enhanced by using technologically latest levelling brightness. To enhance the corrosion resistance, micro porous nickel plating is done prior to chrome plating.

Spokes. All our chrome wire wheels are built with stainless steel spokes and nipples.

Fitting instruction. Every centre lock wire wheel comes with fitting instruction to assist in solving problems that are commonly encountered when balancing centre lock wire wheels on an electronic balancer.

Competition wire wheels. For running our competition wire wheels modifications on the front and rear wings will be necessary.

Painted wire wheels. Our painted wire wheels are primer coated by first using Cathodic Electrophoretic Technology. This increases the corrosion resistance to very high levels. An overcoat of silver grey follows this.

- 1 Wire wheel - 4.0J x 15"
number of spokes: 48, rim inset: 19.00 mm, wheel weight: 6.90 kg, maximum wheel load: 318 kg
215191 Chromed
2726 Painted
- 2 Wire wheel - 4.5J x 15"
number of spokes: 60, rim inset: 19.00 mm, wheel weight: 7.20 kg, maximum wheel load: 310 kg
1595 Chromed
2021 Painted
- 3 Wire wheel - 5.5J x 15"
number of spokes: 72, rim inset: 13.00 mm, wheel weight: 9.70 kg, maximum wheel load: 450 kg
201870 Chromed
2727 Painted
- 4 Wire wheel - 5.5J x 15"
number of spokes: 70, rim outset: 10.00 mm, wheel weight: 8.25 kg, maximum wheel load: 450 kg
competition wheel - for wings with flares only
2720 Chromed
316547 Painted



5 Wheel packages

485487 Chromed, 5.5 x 15" with 72 spokes.
Tyre: 185/80HR15 93H Michelin XVS-P

485488 Chromed, 5.5 x 15" with 72 spokes.
Tyre: 185/80HR15 Vredestein Sprint Classic

485489 Chromed, 5.5 x 15" with 72 spokes.
Tyre: 185/70HR15 Vredestein Sprint Classic

6 **307067** Wire wheel conversion kit
this kit contains four splined hubs with 8 TPI and all the necessary fixing hardware. Our Conversion kit do not contain the wire wheels and the spinners

7 Minator Alloy wheel - 5.5J x 15"
with 8 spokes, 42 mm centre lock type

16384 Silver painted

16387 Anthracite painted

8 **487077** Alloy wheel - 6.0J x 15"
42 mm centre lock type, rim offset: 6 mm, wheel weight: 10.5 kg, silver painted

**4 Catalogues, you must have:
f.o.c.**

- Accessories
- Tuning and more



- Tools
- Oils and lubricants

Order online: www.Limora.com • www.scparts.co.uk



9 Octagonal spinner

- 9373 LH side
- 1223 RH side

10 Two eared spinner

- 615 LH side
- 614 RH side

11 Three eared spinner

- 9746 LH side
- 9743 RH side

Thor Hammers

made in England to high quality standards, these soft-faced hammers provide a safer alternative to striking with conventional steel hammers in industrial applications. The resilient faces shape themselves to the part being struck. Acting as shock absorbers, they spread the force of the blow uniformly, minimising inefficient rebound and damage to components. The Thor Hammer Company is a traditional british supplier and known for superior quality. Thor hammers were original equipment in many Jaguar, Triumph TR and MG tool kits of the 50's and 60's.

12 878 Thor Hammer - copper/hide, weight: 1000 g.

13 2183 Thor Hammer - lead alloy, weight: 1000 g.

14 671 Spanner for octagonal spinners

15 213169 Spanner for octagonal spinners, made from bronze

16 326088 Large spanner for octagonal spinners, long version for providing much greater leverage

17 327498 Wooden spinner saver for 2 eared spinners, made from 23 mm Multiplex

18 326089 Large spanner for 2 eared spinners, long version for providing much greater leverage

19 7339 Spoke brush
solid round brush with wooden handle,
length: 38 cm

20 11321 Spoke wrench
for tightening spokes, length: 200 mm



21



22

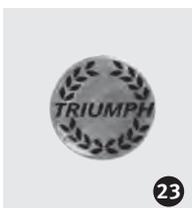

23



24

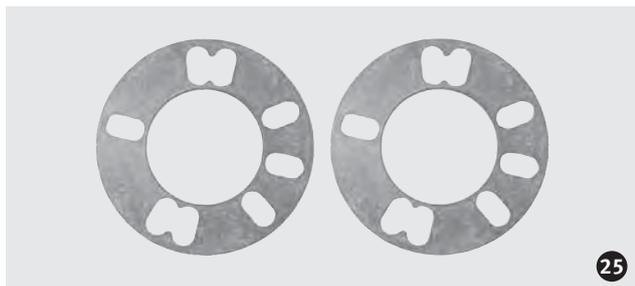

25



26



27



28



29

- 21 Minator Alloy wheels
 - 17244** 5.5J x 15", with 8 spokes, bolt-on fitment, rim inset: 15.00 mm, silver painted
 - 17245** 5.5J x 15", with 8 spokes, bolt-on fitment rim inset: 15.00 mm, anthracite painted
 - 319931** 6.0J x 15", with 8 spokes, bolt-on fitment, rim inset: 8.00 mm, silver painted
- 22 **309025** Hub cap for Minator bolt on-alloy wheels
- 23 **339190** Badge for centre cap with ,TR' logo, diameter: 40 mm
- 24 **305614** Wheel nut chromed for Minator bolt-on alloy wheels
- 25 Wheel spacers - supplied in pairs
 - 14977** 3 mm version
 - 315658** 6 mm version
- 26 **312001** Tyre valve caps chromed with ,TR' logo. Supplied in set of 4
- 27 Tyres
 - 205289** Michelin Tyre XAS - 165/80H15
 - 485657** Michelin Tyre XAS - 185/80HR15 93H
 - 485658** Vredestein Tyre Classic - 185/80HR15
 - 356051** Vredestein Tyre Classic - 185/70HR15
 - 212629** Dunlop Tyre - 185/80VR15
- 28 **336225** Rim band to fit 15" wheels
- 29 Inner tubes
 - 205290** 165 x 15"
 - 206365** 185 x 15"



30

30 Revolution Alloy wheels
 ,Classic' look - bolt-on fitment, 5 spokes, black with polished rim

339137 6.0j x 15" - Road use

339138 7.0j x 15" - Road use

339139 6.0j x 15" - Race use

339140 7.0j x 15" - Race use

31 Revolution Alloy wheels
 3-piece lightweight race type - bolt-on fitment, 4 spokes, black with polished rim

479055 6.0j x 15"

479057 7.0j x 15"

Please find fittings for Revolution wheels below

32 Wheel nuts - chromed

339141 For ,Classic' look Road wheels

348834 For ,Classic' look Race wheels

no ill. **479056** Bolt kit for 3-piece lightweight wheels



31



32

4 Catalogues, you must have: f.o.c.

- Accessories
- Tuning and more



- Tools •
- Oils and lubricants •

Order online: www.Limora.com • www.scparts.co.uk

21.19



1 123 Ignition system for 4 cylinder models with Lucas distributors, negative earth and electric tachometer

485462 With top entry distributor cap

295886 With side entry distributor cap

- **Less emissions**
- **Better starting**
- **Maintenance-free**
- **Simple installation**
- **Variable dwell-angle**
- **Lower fuel consumption**
- **Attractive "original" look**
- **Stronger spark at all speeds**
- **Smooth engine torque curve**
- **Easy timing: with built-in LED**
- **Spark balancing: less noise & more power**
- **16 user selectable electronic advance curves**
- **Available for 4, 6, 8 and 12 cylinder engines**

Buy a 123 ignition now! Enjoy today's standards of reliability and performance. Join the rapidly growing group of trouble-free classic car owners. 123 ignition distributors are available for many engines!

Introducing the "123 ignition"

The ignition-system in a classic car is often the source of many problems. After years of use, the mechanical distributor becomes worn and increasingly inaccurate.

Although replacement of the standard points with an optical eye or magnetic ignition set-up is an improvement, it does not compensate for the wear in the advance-mechanism, the distributor shaft and bearings within the distributor itself.

The 123 ignition distributor is different. It comes in its own aluminium billet and nickel plated housing, although externally similar in its classic appearance to its mechanical counterpart, it contains high-tech electronics on the inside. While maintaining classic appearances under the bonnet, the internal technology makes your ignition system and engine perform better than ever before.

The 123 ignition is only available for negative earth cars.

For more information please order our free leaflet

247191 SC Parts English version

246731 Limora English version

294570 Limora French version

21.19

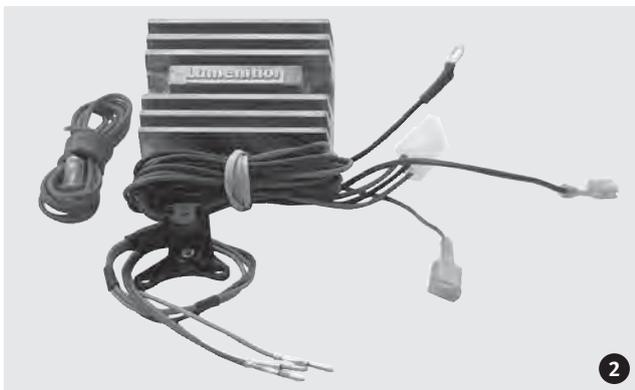

2

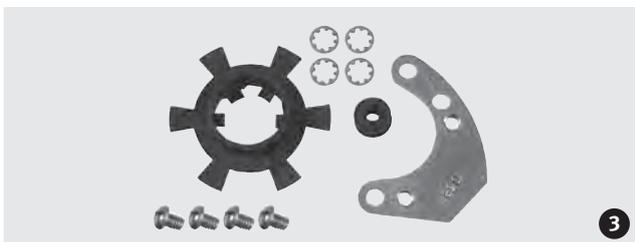

3



4



5



6



7

Lumenition Optronc Ignition system

the Lumenition Optronc Ignition Systems are well known as being among the finest after market electronic ignition systems available. The Lumenition Optronc Ignition is an electronic ignition conversion principally for cars fitted with mechanical distributors using contact set and condenser. There are only three components, very compact and simple to fit. First the optical switch, this contains a light emitting diode (LED) which sits on the switch bracket opposite a matching silicon photo transistor which receives or „sees“ the infra red beam. Secondly, the interrupter called a chopper which is fitted over the cam, rotates interrupting the beam of light causing a pulse. It has one bade for each cylinder of the engine. Thirdly a power module receives this pulse via its internal electronic device which switches the ignition coil on hand off. The coil produces a high tension spark when switched off and is recharged when switched on. The installation can be carried out in most cases in less than an hour, a little longer with distributors that have the advance mechanism over the top of the original contact set. The advantage of the Lumenition Optronc system is that it contains no wearing parts, requires no adjustment or maintenance during service and once ignition timing is set it will remain permanently in tune. The engine will run better, more economically through improved efficiency, last longer and start better. Lumenition Optronc Ignition is suitable for vehicles with or without ballast resistor systems and/or voltage triggered tachometers. For positive and negative earthed cars.

- 2 **313606** Lumenition Optronc Ignition module for Lucas distributors
- 3 Lumenition fitting kits for distributors with Optronc module
 - 313608** For Lucas 22D, 23D and 25D distributors
 - 313611** For Lucas 43D, 45D, 48D, 54D and 59D distributors. Not suitable for vehicles with electronic ignition
- 4 Lumenition Magnetronic Ignition system

the Lumenition Magnetronic Ignition System is designed as a budget electronic conversion for owners requiring the original look. All parts are neatly contained within the distributor unit. The system utilises the proven ‚Hall Effect‘ magnetic pick-up and a unique triggering device. There are not any touching or wearing components, ensuring timing will remain accurate once installed. For negative earthed cars only.

 - 317778** For Lucas 25D4 distributors
- 5 Pertronix electronic ignition system
 - 286805** For Lucas DM2P4 distributors. Positive earthed cars
 - 245018** For Lucas 25D4 distributors. Positive earthed cars
 - 343192** For Lucas 25D4 distributors. Negative earthed cars

Please find single Pertronix components for individual conversion below

- 6 Pertronix High performance ignition coil ‚Flame-Thrower‘
 - primary resistance: 3 ohms, max. output: 40.000 volts
 - 486253** Oil filled type - chromed
 - 486254** Oil filled type - black
 - 486256** Epoxy filled ‚high vibration‘ type - black
- 7 Pertronix High performance ignition lead kits
 - with straight plug boots and 90° angled distributor boot. Carbon impregnated fibreglass core, spiral wound stainless steel alloy, inner insulation with latex and EPDM, outer insulation with silicone
 - 486261** Black
 - 486260** Blue
 - 486259** Red

21.20

Competition parts and accessories

Distributors, spark plugs, ignition coils

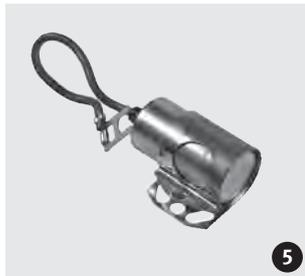

- 1 **45D4** Distributor
specially modified with improved advance curve to suit competition engines
14099 With vacuum advanced unit, for SU and Zenith Stromberg carburetors
314888 Without vacuum advanced unit, for Weber carburetors
- 2 **337600** Housing distributor and tachometer drive made from aluminium
- 3 **314205** Mallory Distributor - dual point type for 4 cylinder carburettor engines

Please find single Mallory components for individual conversion below
- 4 **206266** Mallory Distributor cap
- 5 **313425** Mallory Condenser
- 6 Mallory Contact set
2 per car needed
210805 Standard version with 22 oz.
313424 Heavy duty version with 38 oz.
- 7 **313423** Mallory Rotor arm
- 8 **2422** Lucas High performance ignition coil with push-in HT lead terminal. Approx. 2.8 ohms primary resistance.
Perfect coil when fitting a 123 Ignition or a Lumenition ignition system

4 Catalogues, you must have: f.o.c.

- Accessories
- Tuning and more



Tools •
Oils and lubricants •

Order online: www.Limora.com • www.scparts.co.uk

21.20

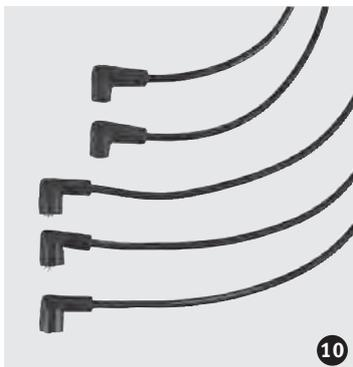

- 9 **3467** Contact set for Lucas 25D distributors competition type for distributors with peg for points TR3, TR3A, TR3B, TR4 and TR4A
- 10 **290693** Ignition lead set high performance type, for top entry cap
- 11 Ignition lead heavy duty, copper in silicone type - supplied per metre
8088 Black
315615 Yellow/black bumble bee
- 12 **316404** HT lead end screwed into cooper ignition lead
- 13 **290870** End kit ignition lead to ignition coil - 3 piece set
- 14 **310906** Terminal ignition lead to ignition coil and to distributor cap
- 15 **310887** Cover ignition lead to ignition coil and to distributor cap
- 16 **12442** Spark plug cap - straight
- 17 **12443** NGK Spark plug cap - 45° angled fits directly to the spark plug
- 18 **4793** NGK Spark plug cap - 90° angled fits directly to the spark plug
- 19 NGK Spark plugs
12432 Standard/Fast Road
12436 Fast Road/Competition
12435 Full Race



1



2



3

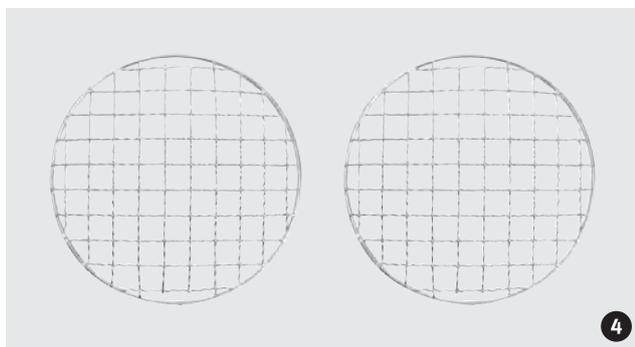

4

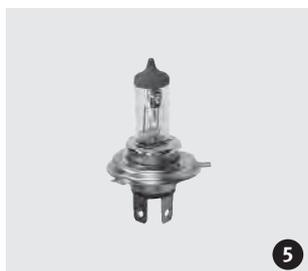

5

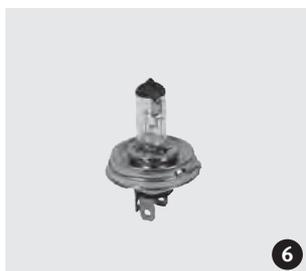

6

- 1 H4 Halogen headlamp conversion kits
 - 5219** 7", no pilot - LHD
 - 14345** 7", with pilot - LHD
 - 938** 7", no pilot - RHD
- 1 **15564** 7", with pilot - RHD
- 2 Lucas H4 Halogen headlamp conversion kits
 - 316422** 7", no pilot - LHD
 - 200577** 7", with pilot - LHD
 - 283616** 7", no pilot - RHD
 - 283617** 7", with pilot - RHD
- 3 H4 Halogen headlamp
 - 316874** 7", no pilot - LHD
 - 355265** 7", with pilot - LHD
 - 471707** 7", no pilot - RHD
 - 471708** 7", with pilot - RHD
- 4 **306968** Stoneguards for 7" headlamps including fitting clips - supplied in pairs
- 5 H4 Halogen bulbs
 - 2876** 60/55 watt, P43t socket, clear bulb surface
 - 323060** 60/55 watt, P43t socket, clear Xenon bulb surface
 - 339258** 60/55 watt, P43t socket, blue Xenon bulb surface
 - 214422** 100/80 watt, P43t socket, clear bulb surface
 - 305032** 160/99 watt, P43t socket, clear bulb surface
- 6 Bilux Halogen bulb
 - 282287** 60/55 watt, P45t base, clear bulb surface

21.21



- 7 Badge bar - stainless steel with brackets for fog or spot lamps
10822 TR2 and TR3
17422 TR3A and TR3B
- 8 **214047** Fog lamp
 pedestal mounted period style lamp with 5.3/4" diameter. Comes with fluted lens and chromed bowl
- 9 **214046** Spot lamp
 pedestal mounted period style lamp with 5.3/4" diameter. Comes with clear lens and chromed bowl
- 10 **22841** Fog lamp
 back mounted period style lamp with 5.3/4" diameter. Comes with fluted lens and chromed bowl
- 11 **22842** Spot lamp
 back mounted period style lamp with 5.3/4" diameter. Comes with clear lens and chromed bowl
- 12 **343599** Spot lamps
 with 5.1/2" diameter. Clear lens with plastic cover and chromed bowl, pedestal mounted - supplied in pairs
- no ill. Replacement bulbs
209894 For 5.3/4" spot and fog lamps (ill. 8 to 11)
25886 For 5.1/2" spot lamps (ill. 9)
- 13 **287383** Hazard warning kit
 for positive and negative earthed cars. Comes with fitting instructions

4 Catalogues, you must have:
f.o.c.

- Accessories
- Tuning and more



- Tools
- Oils and lubricants

Order online: www.Limora.com • www.scparts.co.uk

21.22



1



2



3



4



5



6



7



8



9



10

- 1 Battery - 12 V, 58 AH
needed fixing bolts, part no. 3531
316381 Positive pole on RH side and negative pole on LH side
19592 Positive pole on LH side and negative pole on RH side
- 2 **327890** Battery acid - 1 litre
specifications: 38% sulphuric acid, density: 1.280 s.g.
- 3 **343415** Battery acid mat
neutralizes battery acid and protects your vehicle against corrosion. Size: 12.1/4 x 8.1/4"
- 4 Battery terminal clamp - cable diameter: 9 mm
13728 For negative battery pole
13729 For positive battery pole
- 5 **479870** Battery terminals
speed power type in red and blue, for a quick changing of the battery without a tool. Supplied in pairs
- 6 **479848** Terminal protector rings
comes red and green, prevents oxidation. Supplied in pairs
- 7 **216298** Grease for battery terminals - 100 g tube
our battery terminal grease is acid resistent and water-proof and protects the terminals and other electrical contacts against corrosion and oxidation and provides the proper flow of current.
- 8 **318072** Battery master switch
with a knurled nut for separating the battery from the electric circuit. Comes with bypass fuse for clock, alarm system etc. to maintain memory

Battery master switch
removable key type. This battery switch is an easy and effective way to protect your vehicle against fires and thieves. By switching the key you can disconnect the battery from the entire electric circuit. The switch can be mounted anywhere in your vehicle. The race type edition has additional terminals and suits the FIA requirements for historic racing events.
- 9 **289327** Standard version
- 10 **14412** Race version



11

- 11 C Tek Battery charger
high frequency charger with multistage charging and peak control. Batteries can be charged while they are connected to the car without the danger of harming electric components. Pulse load keeps the battery always at 100% of its cranking capacity. Can be left connected permanently. The smartest charger we could find, fully automatic Swedish High-Tec charger. Safety class IP65 (moisture protected and dust sealed).

XS 800 - for 12 volt batteries up to 32 AH, (maintenance charging up to 100 AH), charging current: 0.8 A

479840 XS800 with Euro plug

373249 XS800 with UK plug

Multi XS 3600 - for 12 volt batteries up to 120 AH, charging current: 0.8/3.6 A

479841 Multi XS 3600 with Euro plug

373516 Multi XS 3600 with UK plug

- 12 Hydrometer - special tool for checking battery acid
479860 with thermometer assembly
479861 without thermometer



12

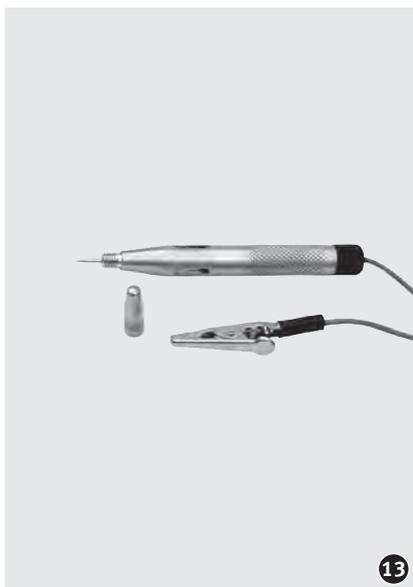

13

- 13 Circuit testing lamp
479867 Brass plated
479868 Nickel plated

21.23

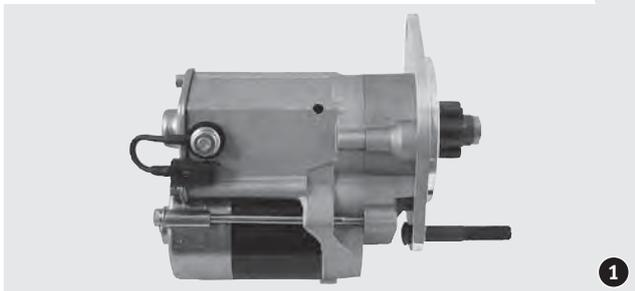

1

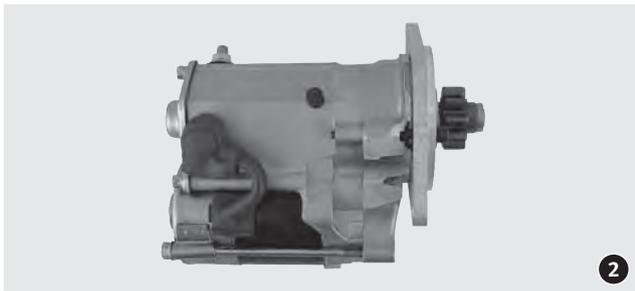

2



3

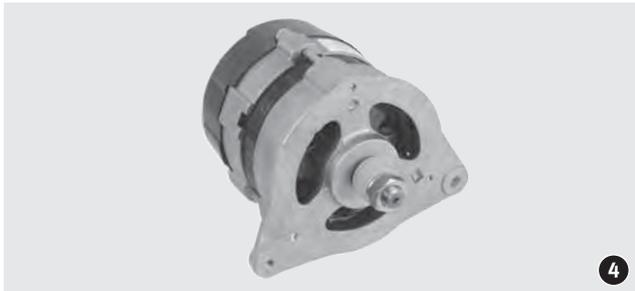

4



5

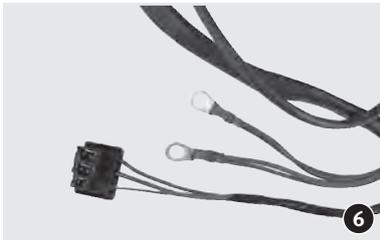

6



7

High performance starter motors

our modern gear reduction, high torque starter motors are specially developed for classic cars. They use a powerful 1.5 kw motor running through a reduction gear box, turning the engine over faster, more powerfully and for longer. No more worries on the start line when the engine is hot. All starter motors are a replacement for the original unit.

- 1 **317415** High performance starter motor
gear diameter: 35 mms, number of teeth: 9
TR2 and TR3, TR3A to TS50000
- 2 **316558** High performance starter motor
gear diameter: 39 mms, number of teeth: 10
TR3A from TS50001, TR3B, TR4 and TR4A

3 Alternator conversion in the original Lucas look with our Superlight AC Alternator conversion kit all Lucas C 40 dynamos with negative earth can be replaced. You can benefit from the following improvements: Since the Superlight Alternator is lighter it uses less motor energy and provides you with more power for the road. Half the weight, twice the power! The Original Look of your classic car is untouched, our product looks like the old Lucas, just hidden inside is the up-to-date high tec. Even your old regulator remains in the car, so the update is not visible. Remove your old dynamo and take of the pulley, spacers and washers and fit them on the alternator. In some cases you need to drill out the pulley with a 17mm drill. Ensure that the pulley is gripped between the nut head and the spacer. Tighten the nut by holding the flats on the shaft end, never insert anything into the commutator. Remove field lead (F) and warning light (WL) from the Regulator and attach together. Remove dynamo lead from the regulator and attach it to the battery positive lead to create a battery positive feed. 1600 rpm 13 Ampere, 2000 rpm 21 Ampere, 2400 rpm 27 Ampere, 3500 rpm 38 Ampere, 5000 rpm 43 Ampere, 6000 rpm 44 Ampere, Maximum power output: 584 Watt, Voltage: 14,89 Volt, Compare with C40: max. approx. 22 Ampere Half the weight, twice the power!

3 **479752** Alternator conversion kit C40
Alternator conversion please find single components for individual conversion below. Only for negative earthed cars. If your car still using a positive earth it will have to be converted. In addition our narrow fan belt kit (part no. 15523) has to be fitted. For more information see chapter 21.5

- 4 **323231** Alternator with 45 amp. output
earth return: negative
- 5 **11376** Fan - alternator
- 6 Wiring loom - alternator
342078 TR2, TR3, TR3A and TR3B, TR4 to CT14913
342079 TR4 from CT14914, TR4A
- 7 **342077** Fitting kit - alternator
including adjustment link.
Please check before fitting: original dynamo pedestal and block bracket must be in satisfactory condition

21.24



1



2



3



4



5



6

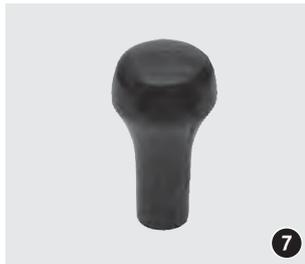

7



8

The wooden veneer panels used in classic cars suffer from exposure to the elements leading to cracking varnish and lifting veneer. Damaged dashboards and door cappings can be easily replaced with one of our high quality panels. Available in elm (bright) or walnut (dark). Made from best California veneer, grinded, polished and coated seven times.

- 1 Wood instrument panel
TR2, TR3, TR3A and TR3B
312715 Walnut
312714 Elm
- 2 Wood dashboard
TR4 and TR4A - LHD models
205414 Walnut
21257 Elm
- 3 Wood dashboard
TR4 - RHD models
307128 Walnut
343003 Elm
- 4 Wood dashboard
TR4A - RHD models
307126 Walnut
21256 Elm
- 5 Wooden door cappings
TR4 and TR4A - supplied in pairs
327999 Walnut
327998 Elm
- 6 Handbrake grip
TR4 and TR4A
9327 Walnut
307115 Elm
- 7 Gear knob
TR4 and TR4A
307572 Walnut
309986 Elm
- 8 Swissvax Wood polish
this incredible wax for both gloss and matt wood finishes contains ultra pure yellow Brazilian grade one carnauba wax for an incomparable shine.
487056 50 ml can with instructions in German
352966 50 ml can with instructions in English

21.25



1



2



3



4



5



6



7

- 1 **450** Brooklands aeroscreen without brackets. Two needed per car TR2, TR3, TR3A and TR3B

Please find fitting components for conversion to Brooklands aeroscreen below

- 2 **18960** Brackets for Brooklands aeroscreens set for one screen TR2, TR3, TR3A and TR3B
- no ill. **5764** Countersunk screw Brooklands aeroscreen to body TR2, TR3, TR3A and TR3B
- 3 **487106** 5 piece bumper kit front bumper including front and rear overrides - stainless steel, mirror polished. TR3A and TR3B
- 4 Threshold plate - aluminium TR2, TR3, TR3A and TR3B
 - 527** RH inner sill
 - 526** LH inner sill
- 5 Threshold plate - stainless steel TR2, TR3, TR3A and TR3B
 - 2561** RH inner sill
 - 2560** LH inner sill
- 6 **19566** Threshold plates outer sill aluminium. Supplied in pairs TR4 and TR4A
- 7 **3219** Threshold plate outer sill stainless steel with 'Triumph laurel wreath' logo TR4 and TR4A

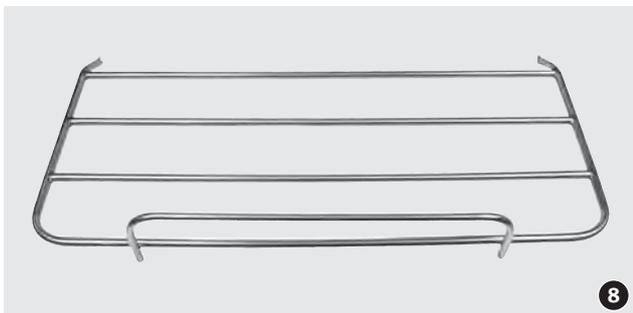

8

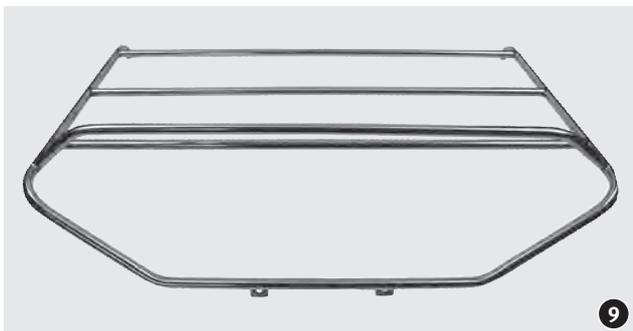

9



10



11

- 8 Boot rack
TR2, TR3, TR3A and TR3B
15921 Stainless steel
386 Chromed
- 9 Boot rack
TR4 and TR4A
16575 Stainless steel
3881 Chromed
- 10 **17203** Wind wings
made from plexiglass. Simply clip on the side of the
windscreen frame. No need for drilling - supplied in
pairs
TR2, TR3, TR3A and TR3B
- 11 Sun visors
made from tinted and polished plexiglass. They fit on the top
of the windscreen
11322 TR2, TR3, TR3A and TR3B
two needed per car
16273 TR4
supplied in pairs

**4 Catalogues, you must have:
f.o.c.**

- Accessories
- Tuning and more



- Tools •
- Oils and lubricants •

Order online: www.Limora.com • www.scparts.co.uk

21.26

Competition parts and accessories

Decals and identification plates



1



2



3



4



5

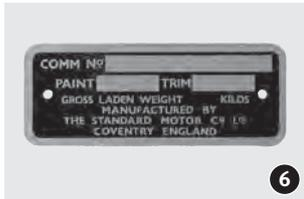

6



7



8



9



10



11



12



13

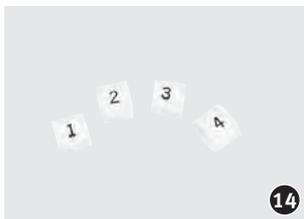

14

- 1 **2759** Chassis plate - TR2
- no ill. **21454** Rivet - chassis plate retaining
- 2 **2760** Chassis plate - TR3 to TS13045
- no ill. **21454** Rivet - chassis plate retaining
- 3 **2761** Chassis plate - TR3 from TS13046, TR3A and TR3B
- no ill. **21454** Rivet - chassis plate retaining
- 4 **2762** Chassis plate - TR4
- no ill. **10085** Pop rivet - chassis plate retaining
- 5 **2763** Chassis plate - TR4A
- no ill. **10085** Pop rivet - chassis plate retaining
- 6 **14495** Chassis plate - TR4A
- no ill. **10085** Pop rivet - chassis plate retaining
- 7 **17572** Decal oil filler cap TR2
- 8 **14594** Decal oil filler cap TR3 to TR4A
- 9 **14561** Sticker ,Girling' - for supply tank TR3 TS13046 on and TR3A
- 10 **18525** Sticker on air filter ,wash every 5000 miles' TR2, TR3, TR3A, TR3B and TR4
- 11 Sticker on air filter - ,AC'
- 21124** TR4 with separate air filters
- 21444** TR4 models with air filter box and all TR4A
- 12 **21569** Sticker on battery - ,Lucas'
- 13 **14567** Sticker on ignition coil - ,Lucas'
- 14 **21068** Sticker on ignition lead - ,Firing order'



15



16



17



18



19



20

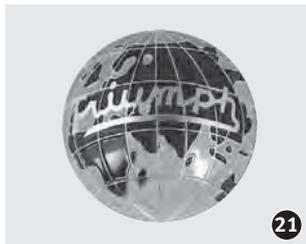

21



22



23



24



25

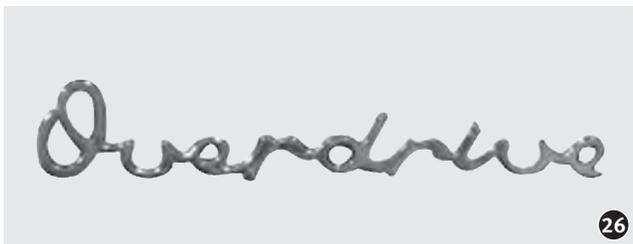

26

- 15 **14550** Sticker on washer bottle - ,Tudor' - set of 3
- 16 **206819** Sticker on washer bottle - ,Lucas electric screenjet'
- 17 **14035** Plate on heater - ,Smiths Heater'
- 18 **14421** Plate on heater - ,Caution'
TR4 and TR4A
- 19 **14434** Sticker on windscreen - ,Triplex laminated'
- 20 **11290** Medallion on hub cap - enamelled
TR2, TR3 to TS13045
- no ill. **215477** Nut for enamelled hub cap medallion
- 21 **247** Medallion on hub cap - painted
TR3 from TS13045, TR3A
- no ill. **215477** Nut for painted hub cap medallion
- 22 **416** Script ,Triumph' on rear shroud
TR3A
- no ill. **3088** Spire nut for ,Triumph' script on rear shroud
- 23 **424** Script ,TR4' on boot lid
TR4 and TR4A
- no ill. **3088** Spire nut for ,TR4' boot lid script
- 24 **428** Letter ,A' on boot lid
TR4A
- no ill. **3088** Spire nut for boot lid letter ,A'
- 25 **429** Script ,IRS' on boot lid
TR4A IRS
- no ill. **3088** Spire nut for ,IRS' boot lid script
- 26 **12931** Script ,Overdrive' on boot lid
- no ill. **3088** Spire nut for ,Overdrive' script on boot lid



27



28



29



30

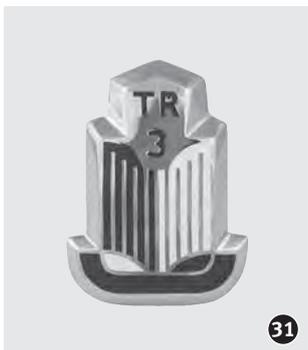

31



32



33

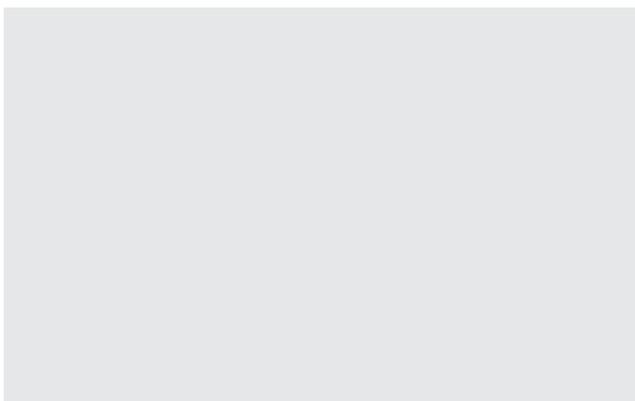

- 27 **2261** Script ,Triumph' on front shroud identify by ribbed face TR3A to approx. TS72000
- no ill. **3088** Spire nut for ribbed ,Triumph' front shroud script
- 28 **2932** Script ,Triumph' on front shroud resp. bonnet resp. boot lid - identify by smooth face TR3A from approx. TS72001, TR3B, TR4, TR4A
- no ill. **3088** Spire nut for smooth ,Triumph' script
- 29 **406** Medallion on front valance - ,Triumph TR2' in red and black TR2
- no ill. **3088** Spire nut for ,Triumph TR2' front valance script
- 30 **11316** Medallion on front valance - ,Triumph TR3' in red and black TR3
- no ill. **3088** Spire nut for ,Triumph TR3' front valance script
- 31 Medallion on front valance ,TR3'
 - 111** In red and black TR3A to TS41873
 - 115** In blue and white TR3A from TS41874 and TR3B
- no ill. **3088** Spire nut for ,TR3' front valance medallion
- 32 **134** Medallion on bonnet - ,TR4' in blue and white TR4
- no ill. **5772** Spire nut for ,TR4' bonnet medallion
- 33 **458** Sticker on bonnet - ,Globe' in blue and red. May replace original enamel medaillon TR4A

4 Catalogues, you must have: f.o.c.

- Accessories
- Tuning and more



Tools •
Oils and lubricants •

Order online: www.Limora.com • www.scparts.co.uk

21.27

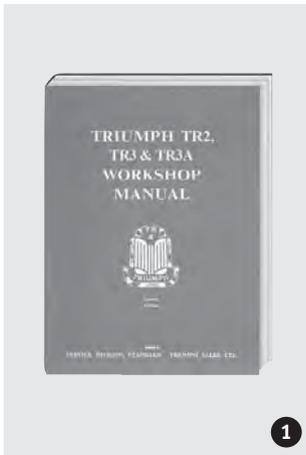

1



2

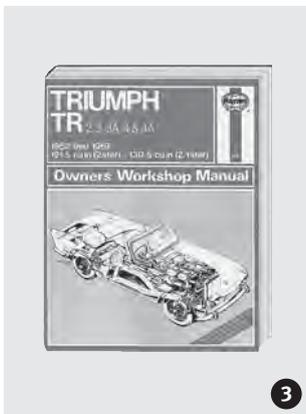

3



4

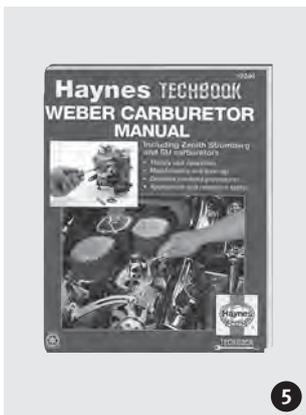

5



6



7

- 1 Workshop Manual for TR2, TR3 and TR3A
approx. 420 pages, 297 x 210 mm, softcover
2451 English version
467736 German version
- 2 Workshop Manual for TR4 and TR4A
360 pages, 297 x 210 mm, softcover
3138 English version
336575 German version
- 3 **21300** Haynes Workshop Manual for TR2 to TR4A
English, 303 pages, 297 x 210 mm, softcover
- 4 The SU Carburettor High-Performance Manual
this manual looks into the basic design of the carburettors, and covers many areas including overhauling, tuning mixture and jet and needle identifications. For following SU carburettor series: H, HS, HD and HIF. Written by Des Hammill
472435 English version, 96 pages, over 50 illustrations, 250 mm x 207 mm, softcover
349260 German version, 85 pages, 297 x 210 mm, hardcover
- 5 **21237** Haynes Workshop Manual for Weber, SU and Zenith Stromberg carburettors
English, 126 pages, 297 x 210 mm, softcover
This carburettor manual looks into the basic design of the carburettors, and covers many areas including overhauling, tuning mixture and jet and needle identifications.
- 6 **293128** Haynes Workshop Manual for SU carburettors
English, 126 pages, 297 x 210 mm, softcover. Written by A.K. Legg.
- 7 **7707** Tuning SU Carburetors
English, 192 pages, 250 x 207 mm, softcover
This manual covers tuning tips and techniques for SU Carburetors as well as all SU fuel pumps for numerous classic cars, including the Mini Cooper, Midget/Sprite, Bentley, Jaguar E-Type, MkII, Daimler V8, Land Rover, MGB, Rolls Royce, TR4 to TR6, TR7, Spitfire, Rover and Volvo 1800. Topics include basic design and function, overhauling and fault finding, mixtures and tuning, burning characteristics of different mixtures, size selection, use of special racing fuels, dismantling and assembly, auxiliary enrichment, automatic enrichment device, electric fuel pumps, mechanical fuel pumps, jet identification and jet needle identification.

21.27

Competition parts and accessories

Workshop manuals and drivers handbooks

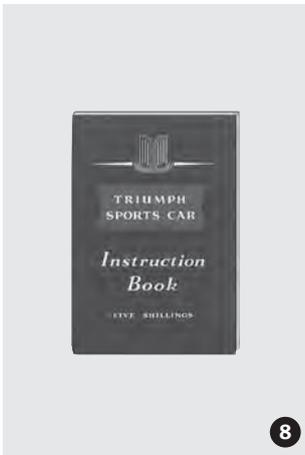

8

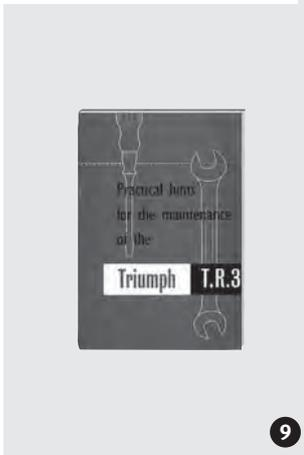

9

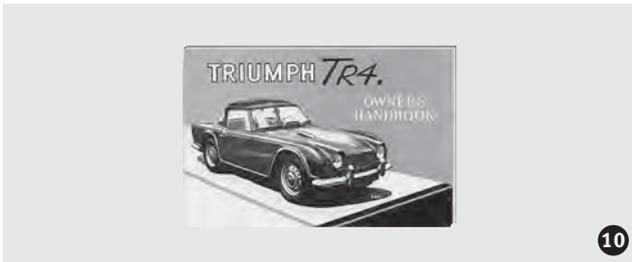

10



11



12



13

- 8 Drivers handbook for TR2
52 pages, 254 mm x 157 mm, softcover
21265 English version
258233 German version
- 9 Drivers handbook for TR3 and TR3A
148 x 105 mm, softcover
21263 English version with 56 pages
318527 German version with 28 pages
- 10 Drivers handbook for TR4
68 pages, 217 x 140 mm, softcover
3112 English version
361417 German version
- 11 Drivers handbook for TR4A
64 pages, 217 x 140 mm, softcover
3111 English version
452872 German version

Original technical publications for Triumph models. A range of workshop manuals, parts books and drivers handbooks on one CD.

- 12 **487025** CD Rom for Triumph TR2, TR3, TR3A
1957 to 1962
- 13 **467994** CD Rom for Triumph TR4, TR4A, TR5, TR250
1961 to 1968

4 Catalogues, you must have: f.o.c.

- Accessories
- Tuning and more



Tools •
Oils and lubricants •

Order online: www.Limora.com • www.scparts.co.uk

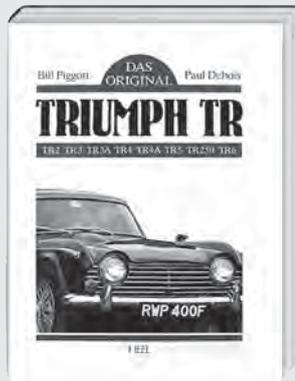

1



2



3



4

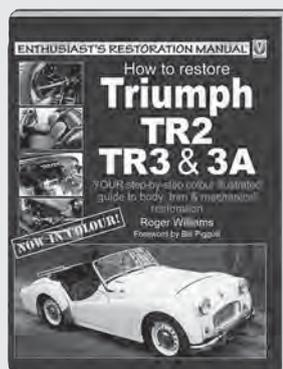

5

- 1 **Original Triumph**
written by Bill Piggott, Photography by Paul Debois - 112 pages, 302 x 232 mm, hardcover.
First-class samples of TR models are comprehensively described here, accompanied by 160 exclusive and brilliant colour pictures, showing detailed parts of bodywork, interior and mechanical components.
355025 German version contain all TR2 to TR6 models
21021 English version contain only TR4 to TR6 models
- 2 **Triumph TR**
a book from the Haynes Great Cars Series. Written by Bill Piggott - 160 pages, 250 illustrations, 250 x 250 mm, hardcover.
The Triumph TR range is among the most popular British sports cars of all, on both sides of the Atlantic. These traditional two-seater roadsters are really in the limelight at the time of this book's publication, as 2003 is the 50th anniversary of the breed and this landmark is being celebrated at various special events. The cars covered in this book range from the basic four-cylinder TR2 introduced in 1953 to the hairy-chested six-cylinder TR6 that finally bowed out of production in 1975, to be replaced by the unloved TR7.
342539 German version
464805 English version
- 3 **299503** **Triumph TR's**
a book from the Collector's Guide series. Written by Graham Robson - German, 142 pages, more than 170 illustrations, 235 x 165 mm, hardcover.
The Triumph TRs from first classic TRs, prototypes and special types as well as competition cars explained with all technical informations.
- 4 **13876** **Manual - Competition preparation**
for TR3 and TR4. English, 48 pages, 148 x 110 mm, softcover
- 5 **339554** **Veloce How to Restore TR2 - TR3A**
written by Roger Williams - English, 192 pages, 270 x 207 mm. Foreword by Bill Piggott, 450 b/w illustrations, softcover.
This book covers all Triumph TR2, TR3 and TR3A models, explains the characteristics of the different models, what to look out for when purchasing and how to restore a TR cost effectively. As well as his own substantial experience and that of other amateur restorers, the author had the help of various TR specialists and professional restorers. All this knowledge, allied to substantial photographic coverage, allows Roger Williams to provide truly detailed coverage of complete restoration and good advice on how to overcome common problems.

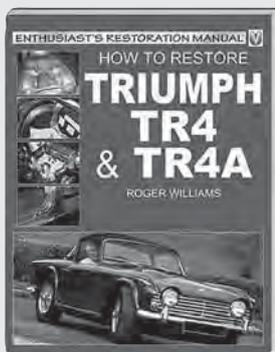

6

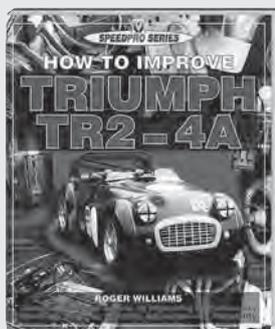

7



8

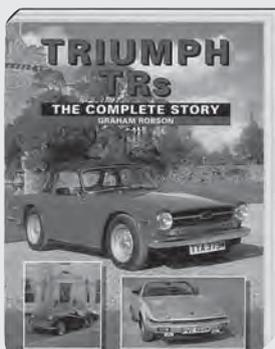

9



10

- 6 **464791** Veloce How to Restore TR4 & TR4A written by Roger Williams - English, 192 pages, 450 illustrations, 270 x 207 mm, softcover. This book covers all Triumph TR4 and TR4A models from 1961-1967. The author explains what to look out for when purchasing and how to restore a TR4 or TR4A cost effectively. As well as his own substantial experience and that of other amateur restorers, the author had the help of various TR specialists and professional restorers. All this knowledge, allied to substantial photographic coverage, allows Roger Williams to provide truly detailed coverage of the complete restoration of TR4 and TR4A Roadsters and good advice on how to overcome common problems.
- 7 **479301** Veloce How to improve TR2 - TR4A written by Roger Williams - English, 144 pages, 250 x 207 mm. Foreword by Peter Cox, 300 coloured, 30 b/w photos, 10 illustrations, softcover. This book applies to all 4-cylinder TR sports cars. Practical and realistic advice on how to improve performance, braking, handling, reliability, appearance and comfort. The author is a production engineer with real hands-on experience of improving these cars. Step-by-step illustrated procedures, colour throughout.
- 8 **16708** Triumph TR2, TR3 & TR3A in Detail written by Bill Piggott - English, 192 pages, 270 x 210 mm, softcover. The Triumph TR sports car were simple, inexpensive, fast and fun to drive, if sometimes wayward on the limit. Here the 1950s first-generation models - TR2, TR3 and TR3A - are described in depth, including development, production, specification changes, competition history and the practical aspects of owning one today.
- 9 **272103** Crowood Triumph TR's written by Graham Robson - English, 192 pages, 106 colour and 78 b/w photos, 260 x 195 mm, softcover. In this book Graham Robson tells the story of some of the most successful of all British sports cars, and how Standard-Triumph began thirty years of success with their TR2 in 1953. From the early origins of the Triumph marque through to the final TR8 model of 1981, all models are covered as well as lesser known prototypes. Superbly illustrated with contemporary and new photographs throughout, this book is a delight for all fans of Triumph sports cars.
- 10 **7712** TR for Triumph written by Chris Harvey - English, 256 pages with 235 illustrations, 297 x 210 mm, softcover. From the popular OIP 'Classic Car Series', this book has been re-issued to satisfy a continuing demand. It provides a wealth of technical information with a fully illustrated history, anecdotes, practical tips, and compulsive reading in the form of contemporary road testers' reports. There is also advice on what to look for when buying a Triumph TR - the strengths and weaknesses of this classic car - hints on restoration and on preparing a car for competition, and fascinating information on the competition successes and the men behind the cars.

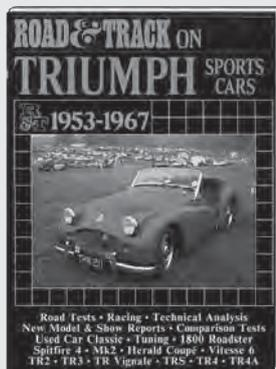

11

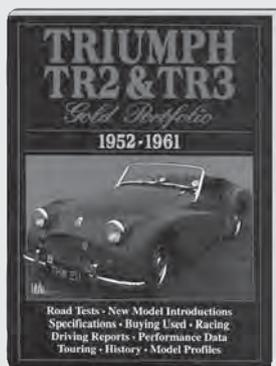

12

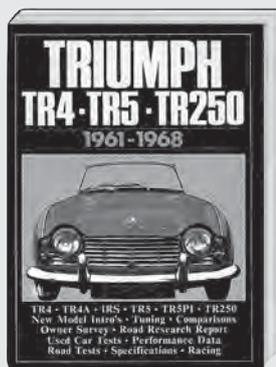

13



14

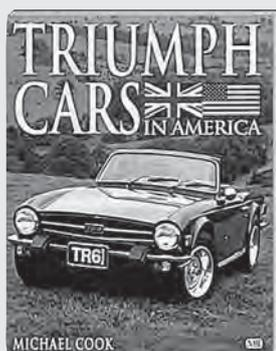

15

- 11 **303018** Road & Track Tests
Triumph Sports Cars (1953 - 67)
English, 88 pages, 270 x 200 mm, softcover.
A Brookland book form the Road and Track series. Official reprints of the original articles taken from America's most popular motoring magazines, includes various test reports.
- 12 **307059** Triumph TR2 & TR3 (1952-1961)
Englisch, 172 pages, 450 illustrations, softcover.
A book from the Gold Portfolio series. Official reprints from British period motoring magazines, they review all areas of the vehicle. Includes road test reports, tuning information, as well as purchase tips and a lot of specified photos.
- 13 **303014** Triumph TR4, TR5, TR250 (1961-1968)
English, 100 pages, 177 illustrations, softcover.
A book from the Gold Portfolio series. Official reprints from British period motoring magazines, they review all areas of the vehicle. Includes road test reports, tuning information, as well as purchase tips and a lot of specified photos.
- 14 **293435** Triumph - Sport and Elegance
A book from the classic makes series.
Written by Bill Piggott - English, 160 pages, 110 coloured and 40 black/white illustrations, 270 x 210 mm, hardcover.
The inside story of a popular make that has always had a special place in the hearts of sports car enthusiasts, and manufactured some acclaimed saloon cars as well. The varied content includes technical information, driving impressions and buying hints.
- 15 **293847** Triumph Cars in America
written by Michael Cook - English, 192 pages, 250 black/white illustrations, 273 x 210 mm, softcover.
As with most postwar British sports cars, a large portion of the Triumphs produced in the 1950s and 1960s were exported to the United States. As a result, the demands of U.S. customers essentially defined what a Triumph sports car would be. This automotive history tells the colorful tale of Triumphs successes in the United States, how the marque was established, its dealer network, promotional and marketing efforts, racing ventures that starred legendary drivers like Stirling Moss and Bob Tullius, profiles of U.S.-exclusive models, and, finally, Triumphs sad defeat under the umbrella of British Leyland. A huge collection of black-and-white photography, much of it archival and not seen in print for decades, imparts a sense of this British marques jolly good run in the United States.

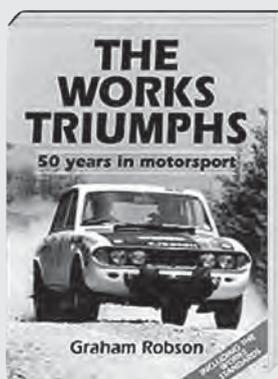

16

16 **25739** The Works Triumphs - 50 Years in Motorsport
Written by Graham Robson - English, 296 pages, 319 illustrations, 241 x 178 mm, hardcover.
For more than half a century Triumph cars were strong contenders on the international race and rally scene, but their many successes were punctuated by financial crises and changes in company ownership, until the British Leyland axe finally fell just after the 1980 Lombard/RAC Rally. In this classic book author Graham Robson - Triumph co-driver and team manager - recaptures the thrills and problems of those turbulent years.

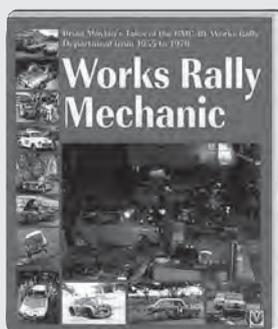

17

17 **299620** Veloce Works Rally Mechanic
the BMC/BL Works Rally Department from 1955 to 1979.
Written by: Brian Moylan - English, 160 pages, 150 illustrations, 250 x 207 mm, softcover.
This book tells the inside story of BMC's/BL's Competition Department from 1955-1979 under the management of Marcus Chambers, Stuart Turner, Peter Browning, Basil Wales, Richard Seth-Smith, Bill Price and John Davenport. A story of adventure, hilarious events, hardship, winning, losing, real danger and BMC's/BL's corporate politics.
Brian Moylan spent 22 years with the Competition Department preparing cars for international rallies and travelling the world to provide service support during the rallies. During this period, Big Healeys, Minis and TR7s were amongst the front runners in the world rally scene, though many other BMC/BL models also saw use as rally cars. The author tells from a mechanic's point of view how BMC/BL rally cars evolved during this important period.

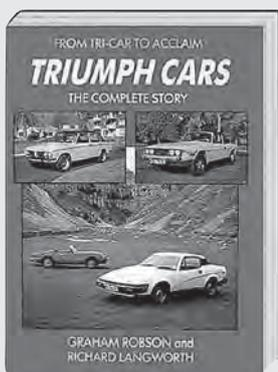

18

18 **478957** Triumph Cars: The Complete Story
written by Graham Robson and Richard Langworth - English, 352 pages, 520 illustrations, 246 x 186 mm, softcover.
The definitive story of all Triumph cars made from 1923 to 1984, of the distinguished and often controversial people who led the company, and the marque's performances on both road and track.
Chapters:
The Quality Light Car; The last word in the smallest class; From Scorpion to Southern Cross; The Smartest Cars in the Land; The big one that got away; Dolomite and demise; War and resurrection; Roadster and Renown; Mayflower: A second American invasion; The sports car America loved best; Hark the Herald angle; 'Bomb' and beyond... the Spitfire story; 'Sabrina' and a new TR; Leyland takes over; Triumph for the 1970s; TR7 and TR8; Acclaim - badge engineering for a sad end; Prewar portfolio; Postwar portfolio. Appendices: Triumph derivations; Production factories 1923-1984; Technical specifications 1923-1984; Triumph and Standard body sources 1945-1984; Triumph production totals 1923-1984; Triumph car clubs.

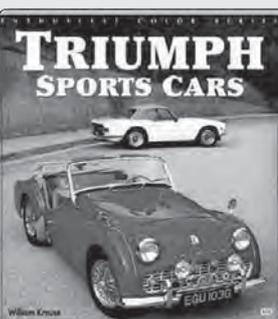

19

19 **478958** Triumph Sports Cars
written by William (Bill) Krause - English, 96 pages, 80 coloured and 10 black/white illustrations, 229 x 210 mm, softcover.
The cars of Triumphs TR series, Spitfires, and GT6s are quintessential British sports cars. Triumph Sports Cars recounts the colorful history of Triumphs successful sports cars, and includes coverage of technical development, promotions, racing, competition with other imports, and Triumphs ultimate decline under British Leyland.

21.29



1



2



3



4



5



6

- 1 **19072** Jack
TR2 to TR4
- 2 **470250** Ratchet for jack
TR2 to TR4
- 3 **289983** Jack - original style
TR4A
- 4 **310517** Jack - replacement type
TR4A
- 5 **339126** Coil spring compressor - original Sykes Pickavant
- 6 **311484** Coil spring compressor
with 190 mm maximum opening. Hooks manu-
factured from tension ductile iron with galvanized finish.
Supplied in pairs

**4 Catalogues, you must have:
f.o.c.**

- Accessories
- Tuning and more



Tools •
Oils and lubricants •

Order online: www.Limora.com • www.scparts.co.uk



7

- 7 **294556** Puller for rear hub
enables quick and safe removal of rear hub flange
without damaging the surface



8

- 8 **19182** Spanner
for oil filter plug on ,A' type overdrive



9

- 9 **10280** Square key
to secure wheel spats, side screens bonnets and boot
lids



10

- 10 **21272** Tool
for retaining clips and weather strips



11

- 11 Alignment tool for clutch
16275 Variant with 10 splines - TR2 to TR4
25700 Variant with 23 splines - TR4A



12

- 12 **20661** Tool kit for SU carburetors
three-piece including jet linkage spanner



13

- 13 **19067** Adjusting tool
for idle mixture screw on Zenith Stromberg carbu-
rettors

21.30



1



2

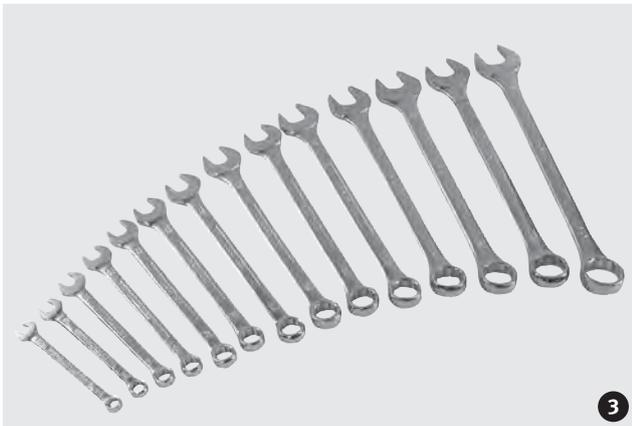

3



4



5

- 1 Socket sets - mm and af
 Draper Expert Hi-Torq™ sockets have 6 or 12 corners with a special radius design giving added torque. This design also extends the life of the socket and fastener. These sockets have a hole for positive ball retention in accordance with DIN 3120 specification. Expert quality socket set manufactured from chrome vanadium steel hardened, tempered, chrome plated and polished for corrosion protection. Packed in blow mould carrying case and display sleeve.
311692 42 piece. 1/2" square drive
306849 42 piece. 3/8" square drive
214942 75 piece. 1/4" square drive
- 2 Gear wrench
479871 supplied in sets of six with 7/16, 1/2, 9/16, 5/8, 11/16, 3/4" wrenches. With 5° drive and fixed head
244339 supplied in sets of seven with 3/8, 7/16, 1/2, 9/16, 5/8, 11/16, 3/4" wrenches. With 5° drive and 180° flex action head
- 3 Combination spanner set - made from forged from chrome vanadium steel. Comes with tool bag
214943 14 piece: 3/8, 7/16, 1/2, 9/16, 5/8, 11/16, 3/4, 13/16, 7/8, 15/16, 1, 1.1/16, 1.1/8 & 1.1/4"
311507 11 piece: 1/4, 5/16, 3/8, 7/16, 1/2, 9/16, 5/8, 11/16, 3/4, 13/16 & 7/8"
204790 6 piece: 3/8, 7/16, 1/2, 9/16, 5/8 & 3/4"
- 4 Torque wrench with reversible ratchet head
 The lb-ft and Nm scale is engraved on the barrel of the wrench. The micrometer type sleeve allows accurate preset torque values to be set. When torque is reached the wrench produces an audible click and a release of tension. Marked range: 40-210 Nm / 30-154 lb-ft. Overall length 475 mm. Supplied in blow mould storage case.
311625 Torque wrench
- 5 Valve grinder with PVC shaft, 19 and 22mm rubber suction ends
311477 without grinding paste
321618 complete kit with coarse and fine grinding paste.



6



7



8

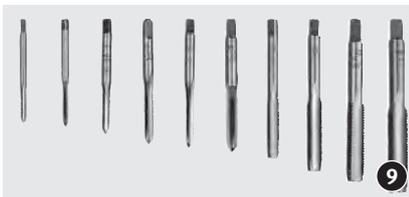

9

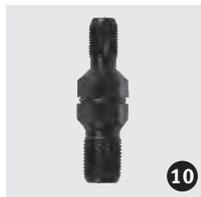

10



11

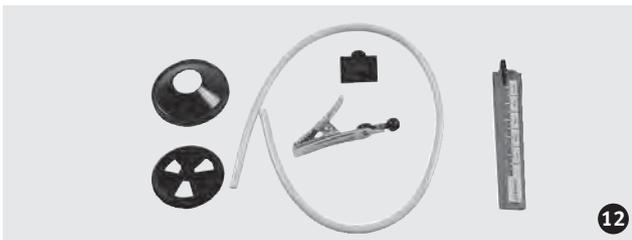

12



13

- 6 **305566** Feeler gauge - imperial, with 10 blades: 0.0015, 0.002, 0.003, 0.004, 0.006, 0.008, 0.010, 0.012, 0.015 and 0.025", length of the pages: 100 mm
- 7 **Nut splitter with chromed surface**
expert quality, manufactured from chrome vanadium steel with square drive ends.
317014 from 9 to 22 mm and from 3/8 to 7/8".
Supplied in a sets of three
328862 from 9 to 12 mm. Length 80 mm
328863 from 12 to 16 mm. Length 105 mm
328864 from 16 to 22 mm. Length 130 mm
- 8 **313529** Gunson's Klikadjust with micrometer adjust tappets precisely, count the clicks for exact micro adjustment, no need to use a feeler gauge
- 9 **328866** Thread chaser and cleaner - supplied in a 10 piece imperial hand tap set. Manufactured from special high carbon steel with accurately cut threads. Contents: No.5, 6, 8, 10 and 12 and 1/4, 5/16, 3/8, 7/16 and 1/2"
- 10 **307724** Thread chaser and cleaner double ended, 14 and 18 mm, for spark plug threads etc.
- 11 **19831** Gunson's Colortune for 14 mm spark plugs allows you to see the colour of combustion in your cylinders. The kit includes a special glass topped spark plug, reflective viewing system for difficult plug locations, cleaning supplies and a wall chart with instructions.
- 12 **25749** Gunson's Carburettor balancer for SU and Zenith carburettors - plastic type
- 13 **343265** Gunson's Gastester digital exhaust CO analyser with pulse pump

4 Catalogues, you must have: f.o.c.

- Accessories
- Tuning and more



Tools •
Oils and lubricants •

Order online: www.Limora.com • www.scparts.co.uk



14



15



16



17



18



19



20

- 14 **319923** Ignition electrode tool
4 in 1 kit. Content 6 blade feeler gauge from 0.02“ to 0.04“ and also spark plug gap, wire brush and reamer
- 15 **305567** Spark plug wrench
for spark plugs with 14 mm thread
- 16 **258249** Grease gun - double action tool
for oiling and greasing. Ideal for on-the-road use, contents: 100 ml
- 17 **345595** On board tool kit
contents: 7 combination AF spanner, combination pliers, spark plug wrench, circuit tester, reversible screw driver and feeler gauge. Comes with a vinyl tool roll
- 18 **480895** Gunson's Ignition timing light „Supastrobe“ professional edition with rigid metal case and a digital display for volts, rpm, dwell, and advance degrees. This stroboscope is fitted with a powerful Xenon bulb that provides a brilliant blue/white light which is highly visible even under bright daylight conditions. The signal pick-up is inductive. Suitable for all petrol cars with 12 Volts ignition system. If the system is 6 or 24 Volts the ignition timing can still be adjusted by using a separate 12 Volt battery for the power supply.
 - volts
 - rpm
 - dwell
 - advance degrees
- 19 **306497** Digital infrared thermometer
with built-in laserpointer for exact measurement. Temperature range from -20 to + 520°C or -4 to 968°F. Accuracy: +/- 2°C or 2% of the reading. Response time: 500 mSec. Resolution: 0.2°. Now with an easy-to-use pistol design and illuminated display. Suitable for a lot of tasks around the car and workshop. Check the temperature of the engine, muffler, tires and brakes. Which cylinder is getting hot? A fast detection of faulty components can save time and prevent expensive repairs and severe damage.
- no ill. **471684** Reserve battery for infrared thermometer 306497
- 20 **221361** Tachometer
digital gauge with Laser RPM pick up. With 5 digit LCD-display and a measuring range from 0,1 up to 19999 RPM, Accuracy: +- 0.05%+1 RPM. The built in memory saves min. and max. RPM and the last measured value. Needs four 1.5V AA batteries, not included. With this special meter all rotating parts can be checked. Great diagnostic tool for gearbox, final drive and many other applications on automotive service and repair



1



2



3



4



5



6

Engine oils

- Castrol Classic Engine oil XL30 original oil type for TR2, TR3, TR3A and TR3B models. For pre-1960 veteran, vintage and classic cars. A high quality monograde engine oil which is also used in most types of manually operated gearboxes fitted to vintage and classic cars. This oil offers excellent cold temperature starting and improved oil pressure at high operating temperatures.

329069 4.5 litre, not available in Germany
480856 5 litre
- Castrol Classic Engine oil XL20W/50 a conventional multigrade engine oil of good all round performance, formulated with high quality mineral oils plus selected additives, ideally suited to older technology and classic car engines. Offers excellent oil consumption and a very high level of engine wear protection. Castrol recommendation for TR2 to TR4A models.

329066 4.5 litre, not available in Germany
480855 5 litre
- Penrite Engine oil HPR30 this premium oil offers a unique viscosity range, are non-friction modified, multigrades made in Australia specially for high temperatures, high speeds and high loads. Formulated for use in conventional engines operating under a high load environment. It provides better oil pressure and consumption control. A SAE20W/60 oil which replaces originally recommended SAE30 und 20W/50 oils. This oil meets the requirements of API SM/CF, ACEAA3/B3, M2C 153G, VW 501.01. Penrite recommendation for TR2 to TR4A models.

22856 5 litre
22857 1 litre
- Penrite Engine oil Classic 20W/50 a high quality, non-friction modified engine oil for classic cars manufactured between 1960 and 1980. This 20W/50 oil meets the performance requirements of API SJ/CF. Suitable for general purpose applications in mid range motor vehicles.

294698 5 litre

Running in oils

- are designed to promote and control the bedding in process of newly rebuilt engines. Drive the car under moderate loads and revs for 500 miles and then carry out normal drain procedures. Refill the engine with manufacturer recommended oil and drive the car under normal conditions but not under excessive loads for a further 1200 miles. Drain the oil and replace with new lubricant. Oil filter changes should be made each time the engine lubricant is replaced.
- Castrol Running in oil No. 2 mineral based, multigrade, crankcase lubricant. Designed to facilitate running-in of new and reconditioned diesel and petrol engines.

329078 5 litre
 - Penrite Running in oil SAE 20W/50 meets the requirements of API SF/CC specifically formulated to provide the best possible lubrication during the critical run-in period.

212134 5 litre
212133 1 litre

21.31



7



8



9



10



11



12



13



13

Gearbox oils

- 7 Castrol Gearbox oil EP90 - TR2 to TR4A mineral based, extreme pressure, multi-purpose gear oil. Primarily recommended for the lubrication of spur and helical gears where the manufacturer recommends an EP oil. **290203** 1 litre
- 8 Penrite Gearbox oil Mild EP - TR2 to TR4A an extreme pressure automotive gear oil meeting the requirements of API GL4 for moderate load applications. Mild EP is designed for use in all steel gear sets in Vintage and Classic cars of the 1950's and 1960's. Also suitable for use in many gearboxes where a mild level of extreme pressure protection is required. Benefits: protects against wear, good anti-friction characteristics, compatible with copper alloy components and protects against corrosion, can be used where either SAE90 or SAE140 grades are recommended. Penrite Mild EP gear oil meets the performance requirements of API GL-4 and MIL-L-2105. **212132** 1 litre

Oils for rear axle and differential

- 9 Castrol Gear oil EP90 - TR2 to TR4A mineral based, extreme pressure, multi-purpose gear oil. Primarily recommended for the lubrication of spur and helical gears where the manufacturer recommends an EP oil. **290203** 1 litre
- 10 Penrite Gear oil Mild EP - TR2, TR3 to TS13045 an extreme pressure automotive gear oil meeting the requirements of API GL4 for moderate load applications. Mild EP is designed for use in spiral bevel, worm and pre 1960 hypoid axles. Benefits: protects against wear, good anti-friction characteristics, compatible with copper alloy components and protects against corrosion, can be used where either SAE90 or SAE140 grades are recommended. Penrite Mild EP gear oil meets the performance requirements of API GL-4 and MIL-L-2105. **212132** 1 litre
- 11 Penrite Gear oil Hypoid 80W/90 - TR3 from TS13046, TR3A, TR3B, TR4 and TR4A suitable for most post-1960 hypoid and spiral bevel gear sets where SAE 80, SAE 90 or SAE 80W-90 was specified. Meets requirements of API GL-5. **485836** 1 litre

Oils for lever shock absorbers

- 12 Castrol Damper oil SAE 20W for lever shock absorbers Castrol Fork Oil provides the following benefits: improved damping performance over a wide range of temperatures, fast air release for anti-fade performance, wear protection of suspension components, protection against corrosion of all the internal parts, Castrol's mineral Fork Oil range represents a new standard in mineral suspension fluid technology and can be used in all competition and on-road units. By intermixing the grades the optimum suspension fluid can be designed to suit all types of service and load to maximise suspension performance. **200318** 500 ml
- 13 Penrite Damper oil for lever shock absorbers **373933** No. 1 - perfect oil for general use. 500 ml **305185** No. 2 - perfect oil for racing and heavier cars. 500 ml



14



15



16



17



18



19

20

21

22

Lubricants for non-rack and pinion steering boxes

- 14 Penrite Steering box lube - TR2, TR3, TR3A and TR3B a high viscosity lubricant. Ideal for non-rack and pinion steering boxes fitted to veteran and vintage automobiles. Benefits: Just pourable at normal ambient temperatures, excellent shear stability, will not channel, helps control leakage.
355371 0.5 litre
- 15 Unipart Steering box lube Hypoid EPA 80W-90 - TR2, TR3, TR3A and TR3B extreme pressure multigrade hypoid gear oil for use in non-rack and pinion steering boxes. Suitable for applications where the vehicle manufacturer recommends the use of either SAE 80, 90 or 80W-90 viscosity gear oil to API GL-4 performance level. Particularly effective over a wide temperature range. Meets or exceeds MIL-L-2105.
20735 0.5 litre

Further oils and lubricants

- 16 Castrol LM Grease lithium based, high melting pot grease, specifically designed as a wheel bearing grease for use over a wide range of temperatures. Also suitable for general purpose applications. Temperature range: -30°C to +120°C.
329093 500 g
- 17 Penrite high melt bearing grease calcium complex base grease especially suitable for wheel bearings where exposure to water spray and therefore grease wash-out was a problem.
212127 500 g
- 18 Castrol Everyman Oil high quality light lubricant for locks, hinges, linkages and much more.
329103 250 ml

Pouring jugs

- 19 **329101** Castrol Classic - 1 quart
- 20 **329100** Castrol Classic - 1 pint
- 21 **329099** Castrol Classic - 1/2 pint
- 22 **481158** Penrite - 1 pint

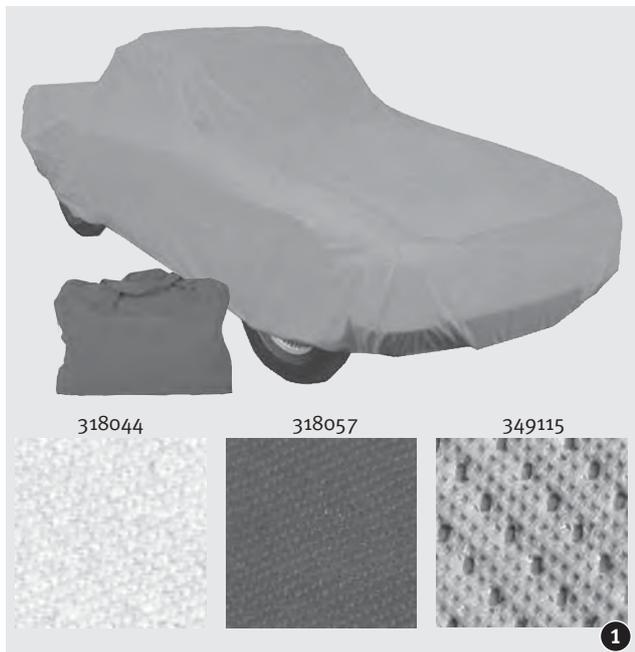

- 1 **Car cover**
 our Car covers are made from high quality materials to ensure that your quality expectations will always be met and surpassed. We use the latest generation materials, double stitching, durable securing straps and purpose made fittings. The range of cover materials to us is, quite simply, vast. We made two indoor covers (ivory and red) and one heavy duty outdoor cover (grey). The breathable indoor covers are made from 100% pure cotton and are supplied with a compact, sturdy bag. The heavy duty outdoor cover comes with a soft lining to protect paintwork. These are substantial covers weighing about 3 kg and packed in a sturdy zipped storage bag with handles. The grey coloured outer skin is soft and pliable, yet totally waterproof, and the stitches seams are heat sealed. Of course you can order your free colour sample: 373538 (ivory), 247615 (red) and 355026 (grey)
318044 Ivory indoor car cover
318057 Red indoor car cover
349115 Grey outdoor car cover
- 2 **318071** Wing cover in red fixed with magnets. Size: 100 x 57 cm
- 3 **318723** Duster made of 100% soft cotton. Lifts dust without scratching the paint
- 4 **355878** Oil drip mat sizes: 90 x 120 cm, oil consumption: 4 litre

4 Catalogues, you must have: f.o.c.

- Accessories
- Tuning and more



- Tools •
- Oils and lubricants •

Order online: www.Limora.com • www.scparts.co.uk



- 5 3-point automatic seat belts
 - 315662** With 45 cm stalk
 - 10210** With 30 cm stalk
 - 315677** With 15 cm stalk
- 6 3-point static seat belt
 - 312473** With 45 cm stalk
 - 5394** With 30 cm stalk
 - 315680** With 15 cm stalk
- 7 **315842** Fitting kit for one seat belt fixing point
this kit contains all brackets, fixings and instructions
for easy installation
- 8 **318070** Tool roll
black PVC with 14 pockets. Dimensions: 68 x 33 cm
- 9 Fire extinguisher
with alloy body. It has an easy to read pressure gauge and
comes with mounting bracket
 - 275432** Content: 1 kg, total height: 30 cm
 - 322326** Content: 2 kg, total height: 39 cm
- 10 Aerial
 - 212604** Electric
 - 16062** Manual
- 11 **17826** Rear mudflaps
with ,Triumph' logo - supplied in pairs

	3/16" UNF	1/4" UNF	5/16" UNF	3/8" UNF	7/16" UNF	1/2" UNF	5/8" UNF
Screw 3/8" UNF	212139	212149	7890	212173	•	•	•
Screw 1/2" UNF	201980	7884	7891	213884	315933	13412	•
Screw 5/8" UNF	212144	3295	212162	7898	13925	10754	•
Screw 3/4" UNF	212145	1912	7893	213886	213907	213909	•
Screw 7/8" UNF	212146	7885	7894	213887	10694	213910	•
Screw 1" UNF	212147	3072	2826	3800	7903	18049	•
Screw 1.1/8" UNF	•	7886	7895	10751	11700	•	•
Screw 1.1/4" UNF	•	212376	7896	213888	10753	213911	•
Screw 1.3/8" UNF	•	4835	7897	10752	14814	•	•
Screw 1.1/2" UNF	•	7888	5177	7901	10728	3776	•
Screw 1.3/4" UNF	•	17908	315907	7902	10729	13927	•
Screw 1.7/8" UNF	•	304184	319260	•	•	•	7904
Screw 2" UNF	•	7889	10749	13111	294837	•	•

	3/16" UNF	1/4" UNF	5/16" UNF	3/8" UNF	7/16" UNF	1/2" UNF	5/8" UNF
Bolt 1"	•	212379	215479	9174	•	•	•
Bolt 1.1/8"	•	11407	•	216331	•	•	•
Bolt 1.1/4"	215700	6514	6521	11439	•	•	•
Bolt 1.3/8"	•	3938	6522	6535	•	•	•
Bolt 1.1/2"	•	3171	3381	3382	3383	•	•
Bolt 1.5/8"	•	•	•	6536	•	•	•
Bolt 1.3/4"	•	6516	6524	213889	13926	212059	•
Bolt 1.7/8"	•	•	4939	13642	•	•	•
Bolt 2"	•	3780	6525	213890	10730	10733	10735
Bolt 2.1/8"	•	•	•	6539	212053	•	•
Bolt 2.1/4"	•	6517	6527	5327	243007	25073	•
Bolt 2.3/8"	•	•	•	15514	•	•	•
Bolt 2.1/2"	•	212378	213876	313891	213883	213913	•
Bolt 2.3/4"	•	315903	213915	9802	612	10734	•
Bolt 3"	•	212377	213881	213892	213908	213914	11675
Bolt 3.1/4"	•	•	26515	6540	5362	19530	304703
Bolt 3.1/2"	•	315904	6533	205324	6544	316875	19393
Bolt 3.3/4"	•	•	315905	5330	7549	•	•
Bolt 4"	•	315934	212037	212779	5326	17905	11697
Bolt 4.1/2"	•	•	6534	205323	6545	17906	•
Bolt 5"	•	•	315906	17902	•	•	•
Bolt 5.1/2"	•	•	•	10727	•	•	•

	3/16" UNF	1/4" UNF	5/16" UNF	3/8" UNF	7/16" UNF	1/2" UNF	5/8" UNF
Nut	2948	2828	2303	3073	2869	3809	16051
Half nut	•	7656	7739	7741	7742	3201	315370
Nut, nyloc	3783	2214	7455	2829	7456	3784	3785
Half nut, nyloc	•	212451	2271	212110	2049	212113	315371
Steel nut, self locking	•	3786	212105	3788	201391	4662	•
Half nut, slotted	•	209253	•	1694	4834	1998	16904
Full nut, slotted	•	•	•	214081	7727	7728	286306
Nut plain brass	•	•	26185	25952	•	•	•

	3/16"	1/4"	5/16"	3/8"	7/16"	1/2"	5/8"
Plain washer	212189	212191	212193	212195	212196	212197	•
Plain washer, large	7793	2831	3241	3811	10164	7800	15584
Spring washer	212190	212192	212194	2051	2215	7461	15001
Spring washer, square section	319071	319072	319073	319074	319075	319076	319078
Spring washer, double coil	317717	6306	6307	2185	•	•	•
Shakeproof washer, internal star	214403	209089	3542	209117	207488	3813	15002
Shakeproof washer, external star	8123	300328	8121	13315	288723	319083	300330
Fibre washer	11440	11441	9418	11442	19102	3870	5634
Copper washer	355119	13351	13407	13352	5465	8977	8210

Screw kit

800 pieces, screws, washers and nuts, 1/4, 5/16 and 3/8" UNF

Part no. 336814



22.1

Hardware

UNC screws, bolts, nuts and washer

	1/4" UNC	5/16" UNC	3/8" UNC
Screw 3/8" UNC	17907	214570	•
Screw 1/2" UNC	7871	288521	10747
Screw 5/8" UNC	212153	7887	214573
Screw 3/4" UNC	7873	7877	16652
Screw 7/8" UNC	212446	212165	25773
Screw 1" UNC	3249	212167	212154
Screw 1.1/8" UNC	7874	212169	7881
Screw 1.1/4" UNC	318716	13109	7882
Screw 1.3/8" UNC	318717	•	212181
Screw 1.1/2" UNC	13918	214571	11797
Screw 1.3/4" UNC	13919	13921	•
Screw 2" UNC	•	•	214727

	1/4" UNC	5/16" UNC	3/8" UNC
Bolt 1" UNC	•	214668	•
Bolt 1.1/8" UNC	17893	337302	•
Bolt 1.1/4" UNC	212447	10717	•
Bolt 1.3/8" UNC	17897	6498	13405
Bolt 1.1/2" UNC	212448	214572	6506
Bolt 1.5/8" UNC	13661	6500	9187
Bolt 1.3/4" UNC	212450	22597	6507
Bolt 2" UNC	212449	6501	315935
Bolt 2.1/4" UNC	•	6502	6509
Bolt 2.1/2" UNC	13662	18344	10720
Bolt 2.3/4" UNC	•	10718	315468
Bolt 3" UNC	•	212033	6510
Bolt 3.1/4" UNC	•	6504	•
Bolt 3.1/2" UNC	•	15412	6511
Bolt 3.3/4" UNC	•	•	6512
Bolt 4" UNC	•	10719	10866
Bolt 4.1/2" UNC	•	6506	•
Bolt 5" UNC	•	17899	•

	1/4" UNC	5/16" UNC	3/8" UNC
Nut	3781	3782	3952
Half nut	•	317631	212795
Nut, nyloc	319283	2689	212796
Nut plain brass	•	318170	201055

	1/4"	5/16"	3/8"
Plain washer	212191	212193	212195
Plain washer large	2831	3241	3811
Spring washer	212192	212194	2051
Spring washer, square section	319072	319073	319074
Spring washer, double coil	6306	6307	2185
Shakeproof washer, internal star	209089	3542	209117
Shakeproof washer, external star	300328	8121	13315
Fibre washer	11441	9418	11442
Copper washer	13351	13407	13352

Screw kit	400 pieces, screws, washers and nuts, 1/4, 5/16 and 3/8" UNC Part no.480661
-----------	---



Inches - Millimetres

3/8	=	9,525	mm
1/2	=	12,700	mm
5/8	=	15,875	mm
3/4	=	19,050	mm
7/8	=	22,225	mm
1	=	25,400	mm
1.1/8	=	28,575	mm
1.1/4	=	31,750	mm
1.3/8	=	34,925	mm
1.1/2	=	38,100	mm
1.5/8	=	41,275	mm
1.3/4	=	44,450	mm
1.7/8	=	47,625	mm
2	=	50,800	mm
2.1/8	=	53,975	mm
2.1/4	=	57,150	mm
2.3/8	=	60,325	mm
2.1/2	=	63,500	mm
2.3/4	=	69,850	mm
3	=	76,200	mm
3.1/4	=	82,550	mm
3.1/2	=	88,900	mm
3.3/4	=	95,250	mm
4	=	101,600	mm
4.1/2	=	114,300	mm
5	=	127,000	mm
5.1/2	=	139,700	mm

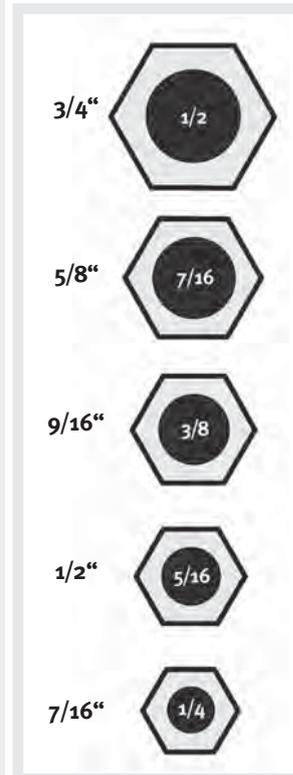
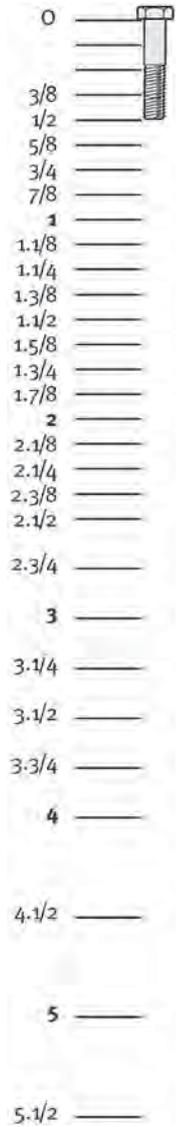

	1/4" BSF	5/16" BSF	3/8" BSF	7/16" BSF	1/2" BSF
Screw 3/8"	288972	•	•	•	•
Screw 1/2"	288973	288977	288984	•	•
Screw 5/8"	288974	288978	•	•	•
Screw 3/4"	288975	288979	23380	288986	•
Screw 7/8"	•	288980	•	•	•
Screw 1"	288976	288981	319414	288987	303123
Screw 1.1/8"	•	288982	•	•	•
Screw 1.1/4"	•	288983	288985	•	•
Screw 1.1/2"	•	319410	319419	•	•
Screw 1.3/4"	•	326847	319418	•	319425
Screw 2"	•	•	•	•	321739



	1/4" BSF	5/16" BSF	3/8" BSF	7/16" BSF	1/2" BSF
Bolt 1"	23360	329163	319415	319423	•
Bolt 1.1/4"	23361	23371	214074	•	•
Bolt 1.1/2"	288963	288965	319420	•	322824
Bolt 1.3/4"	288964	288966	•	•	288968
Bolt 1.7/8"	•	215559	215208	•	•
Bolt 2"	•	23374	303222	319424	•
Bolt 2.1/2"	•	23375	303097	•	•
Bolt 2.3/4"	•	215560	319421	•	•
Bolt 3"	322549	288967	325665	•	•
Bolt 3.1/2"	•	•	325847	•	•
Bolt 4"	•	•	327581	•	•
Bolt 4.1/2"	•	•	325848	•	•
Bolt 5.1/2"	•	•	327099	•	•



	1/4" BSF	5/16" BSF	3/8" BSF	7/16" BSF	1/2" BSF	2BA" BSF	4BA" BSF
Nut	20530	19716	20740	317459	317460	6308	6309
Nut, nyloc	317461	23338	8688	317462	317463	•	•
Nut, slotted	329168	317272	329169	325668	329170	•	•
Nut brass	329171	202609	200839	•	•	•	•



	1/4"	5/16"	3/8"	7/16"	1/2"	2BA	4BA	6BA
Plain washer	212191	212193	212195	212196	212197	212189	•	•
Plain washer, large	2831	3241	3811	10164	7800	•	•	•
Spring washer	212192	212194	2051	2215	7461	212190	•	•
Spring washer, square section	319072	319073	319074	319075	319076	319071	319070	319069
Spring washer, double coil	6306	6307	2185	•	•	317717	•	•
Shakeproof washer, internal star	209089	3542	209117	207488	3813	214403	18630	319080
Shakeproof washer, external star	300328	8121	13315	288723	319083	8123	319079	319081
Fibre washer	11441	9418	11442	19102	3870	•	•	•
Copper washer	13351	13407	13352	5465	8977	•	•	•

22.1

Hardware

Studs, split pins and clevis pins

	1/8"	3/16"	1/4"	5/16"
Clevis pin 1/2"	1438	•	•	•
Clevis pin 3/8"	•	11152	•	•
Clevis pin 7/16"	•	19544	•	•
Clevis pin 9/16"	•	1844	9652	•
Clevis pin 5/8"	•	•	16577	14045
Clevis pin 11/16"	•	19545	22939	204766
Clevis pin 3/4"	•	•	20816	14046
Clevis pin 13/16"	•	•	16757	7134
Clevis pin 7/8"	•	7131	7132	7135
Clevis pin 15/16"	•	300831	•	7136
Clevis pin 1"	•	•	•	14064
Clevis pin 1.1/16"	•	•	•	8709
Clevis pin 1.11/16"	•	•	7133	•



	1/16"	5/64"	3/32"	7/64"	1/8"	9/64"	5/32"
Split pin 1.1/2"	3805	7464	3269	7465	•	•	•
Split pin 2.1/4"	•	•	•	•	7466	18488	7467

	No 4	No 6	No 8	No 10	No 12	No 14
Self tapping screw panhead 1/4"	5692	5693	•	•	•	•
Self tapping screw panhead 3/8"	211193	4163	•	•	•	•
Self tapping screw panhead 1/2"	•	3818	3819	3821	318750	•
Self tapping screw panhead 3/4"	•	3775	219012	3822	3823	307663
Self tapping screw panhead 1"	•	19334	11048	18864	7462	7463



	No 6	No 8	No 10
Self tapping screw, countersunk 1/2"	4004	3268	3816
Self tapping screw, countersunk 3/4"	3814	3815	3817



	No 6	No 8	No 10	No 12
Spire nut flat	3088	3089	318751	6863
Spire nut „U“ type	19416	3824	3081	14958

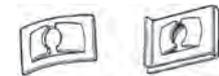

	1/4" F/F	1/4" F/C	5/16" F/F	5/16" F/C	3/8" F/F	3/8" F/C	3/8" C/C
Stud 1"		19548	•	•	•	•	•
Stud 1.1/8"	19625	•	244483	207033	•	•	•
Stud 1.1/4"	19626	•	7998	•	•	•	•
Stud 1.5/16"	•	•	•	•	•	12825	•
Stud 1.3/8"	289018	•	19618	18248	224	•	•
Stud 1.1/2"	•	•	9191	18405	9764	207613	•
Stud 1.5/8"	•	19547	7293	318433	•	7128	5040
Stud 1.3/4"	•	207504	7999	12675	7297	7129	•
Stud 1.11/16"	•	•	•	•	•	•	2331
Stud 1.13/16"	•	•	•	•	•	•	2375
Stud 1.7/8"	•	•	7294	7126	289034	•	•
Stud 1.15/16"	•	•	•	•	•	•	2332
Stud 2"	•	•	•	19627	•	5223	•
Stud 2.1/16"	•	•	•	•	•	•	2344
Stud 2.1/8"	•	•	•	5096	•	•	•
Stud 2.1/4"	•	•	7295	7127	•	•	•
Stud 2.3/8"	•	•	•	•	•	•	2357
Stud 2.1/2"	•	•	7296	294413	•	7130	•
Stud 2.3/4"	•	•	20089	12857	•	•	•
Stud 3"	•	•	•	9166	•	9667	•
Stud 3.1/8"	•	•	20090	9167	•	•	•
Stud 3.1/4"	•	•	•	298894	•	•	•
Stud 3.1/2"	•	•	•	298896	•	19624	•
Stud 3.5/8"	•	•	19616	•	•	•	•
Stud 3.3/4"	•	•	•	306183	•	•	•
Stud 4"	•	•	•	12460	•	•	•
Stud 4.1/4"	•	•	•	203987	•	•	•

22.1

Hardware

Panhead and countersunk screws, hose clips

	1/4 UNF	3/16 UNF	5/16 UNF	No 6 UNC
Panhead screw 1/4"	•	7767	•	214857
Panhead screw 5/16"	•	7768	•	7764
Panhead screw 3/8"	•	7769	•	18621
Panhead screw 7/16"	•	7770	•	•
Panhead screw 1/2"	7853	214337	7856	18604
Panhead screw 5/8"	7854	19369	•	7765
Panhead screw 3/4"	318110	7772	10695	7766
Panhead screw 7/8"	287364	7773	•	•
Panhead screw 1"	18709	5137	25324	18561
Panhead screw 1.1/4"	•	7775	•	•
Panhead screw 1.1/2"	22182	20123	•	•
Panhead screw 1.3/4"	•	7776	•	•

	5/16 UNF	3/16 UNF	1/4 UNF	No 6 UNC
Countersunk screw 1/4"	•	•	•	7138
Countersunk screw 5/16"	•	7139	•	•
Countersunk screw 3/8"	•	7140	•	•
Countersunk screw 7/16"	•	200771	•	•
Countersunk screw 1/2"	•	7142	203531	•
Countersunk screw 5/8"	7863	7143	7858	•
Countersunk screw 3/4"	7864	291953	7859	•
Countersunk screw 7/8"	•	207673	7865	•
Countersunk screw 1"	4868	17215	7860	•
Countersunk screw 1.1/4"	13659	22968	15513	•
Countersunk screw 1.1/2"	5446	•	7862	•
Countersunk screw 1.3/4"	•	•	912	•

Hose clips	No 1	No 2
Diameter: 3/8" - 5/8"	10214	•
Diameter: 1/2" - 3/4"	208944	•
Diameter: 5/8" - 7/8"	3921	•
Diameter: 3/4" - 1"	208946	•
Diameter: 7/8" - 1.1/4"	208947	•
Diameter: 1" - 1.5/8"	208949	•
Diameter: 1.3/8" - 2"	208950	•
Diameter: 1.1/2" - 2.1/4"	208951	•
Diameter: 2" - 2.3/4"	3493	•
Diameter: 2.3/4" - 3.1/2"	20314	•
Diameter: 3.1/4" - 4"	20315	•
Diameter: 3.3/4" - 4.1/2"	10216	•
Diameter: 4.1/8" - 5"	7454	•
Diameter: 7/16" - 9/16"	•	7147
Diameter: 9/16" - 3/4"	•	1611
Diameter: 5/8" - 13/16"	•	1550
Diameter: 11/16" - 7/8"	•	7148
Diameter: 3/4" - 1"	•	1551
Diameter: 13/16" - 1.1/16"	•	7149
Diameter: 1.3/8" - 1.9/16"	•	10063
Diameter: 1.7/8" - 2"	•	22966
Diameter: 1.3/4" - 1.7/8"	•	20317



Worm type

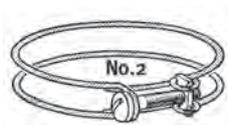

Wire type



4 Catalogues you must have: f.o.c.

Accessories

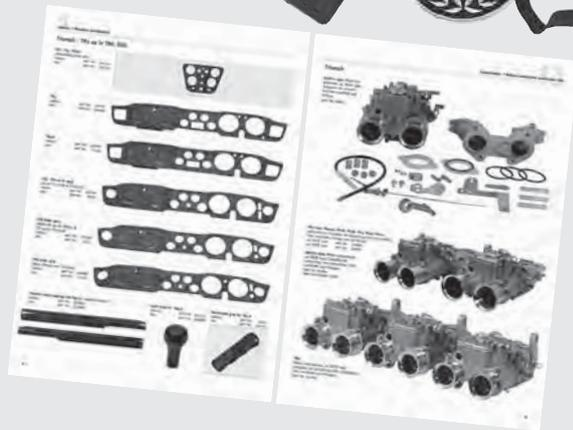
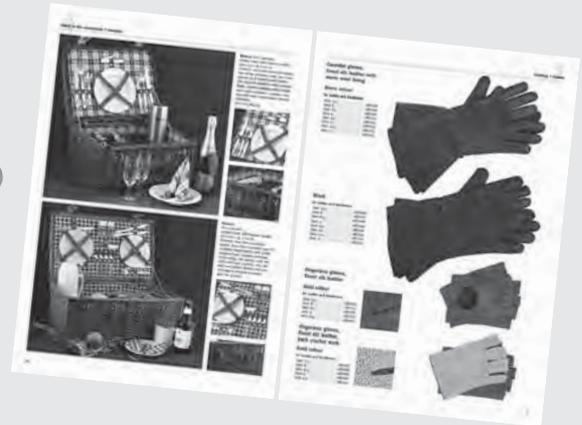

Tuning

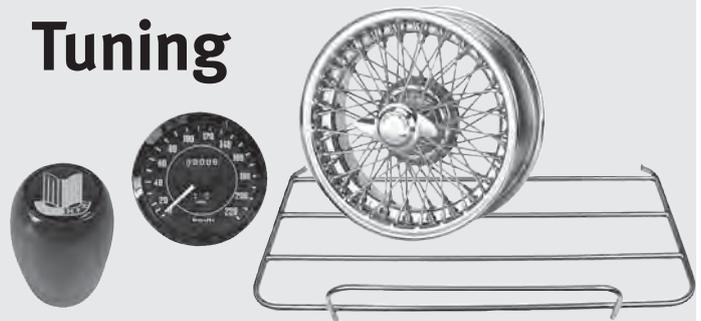

Workshop tools



Oils and lubricants



Order online: www.Limora.com • www.scparts.co.uk

123 ignition 14.3, 21.19
 175CD carburettor 6.7
 3-point seat belts 21.32
 4 pot calipers, conversion kit . . . 21.17
 5-speed gearbox, Getrag 21.3

A

,A' post repair panel, TR2-3B . . . 15.6
 ,A' post, TR2-3B 15.8
 ,A' post, TR4-4A 15.10
 Accelerator pedal 5.1
 Accumulator piston,
 overdrive 2.6, 21.3
 Adhesive spray 20.7
 Adhesives for carpets 20.13
 Adhesives for interior trim 20.7
 Advance board 15.10
 Aerial 21.32
 Aeroscreen, Brooklands 21.25
 A-Fin brake drum 21.17
 Air filter, K&N 21.9
 Air filter, Speedograph 21.9
 Air filter, SU 21.9
 Air filter, SU-H4 6.1, 6.4
 Air filter, SU-HS6 6.10
 Air filter, Zenith Stromberg 6.7
 Air pump 13.2
 Alignment tool, clutch 3.1
 Alloy bonnet, TR2-3B 15.5
 Alloy boot lid, TR2-3B 15.5
 Alloy boot lid, TR4-4A 15.9
 Alloy cylinder head 1.5, 21.2
 Alloy flywheel 21.4
 Alloy fuel tank, TR2-3B 7.1
 Alloy fuel tank, TR4-4A 7.2
 Alloy fuel tanks 21.7
 Alloy oil sump 1.2, 21.1
 Alloy petrol tank, TR2-3B 7.1
 Alloy petrol tank, TR4-4A 7.2
 Alloy petrol tanks 21.7
 Alloy piston set 21.1
 Alloy pulley for crankshaft 21.1
 Alloy radiator 21.5
 Alloy rocker cover 21.2
 Alloy threshold plate 21.25
 Alloy water pump 21.5
 Alloy wheels 21.18
 Alternator 21.23
 Alternator, conversion kit
 in original housing 14.1
 Ammeter, TR2-3B 14.8
 Ammeter, TR4-4A 14.11

Angle drive,
 speedometer cable 2.5, 21.3
 Anti roll bar, front suspension . . 21.15
 Anti roll bar, front
 suspension TR2-4 8.2
 Anti roll bar, front
 suspension TR4A 8.5
 Anti roll bar, rear suspension . . 21.16
 Anti-freeze coolant
 for radiator 21.5
 AP Lockheed brake fluid 3.3
 ARP stud kit 21.1, 21.2
 Autoglym leather care 20.3
 Autoglym metal polish 16.3
 Autoglym screen wash 20.17
 Autoglym vinyl and
 rubber care 20.8
 Automatic seat belts 21.32

B

,B' post repair panel, TR2-3B . . . 15.6
 ,B' post, TR2-3B 15.8
 ,B' post, TR4-4A 15.10
 Badge bar 21.21
 Bars Flush cleaner for
 cooling system 21.5
 Battery 14.5, 21.22
 Battery box 14.5
 Battery cable 14.5
 Battery charger 21.22
 Battery master switch 21.22
 Battery mat 21.22
 Baulk ring, TR2-3A 2.2
 Baulk ring, TR3B-4A 2.4
 Beadings, TR2-3B 18.10
 Beadings, TR4-4A 18.11
 Big end bearing 1.3
 Bilux bulb 14.25
 Bilux halogen bulb 21.21
 Bilux headlamp 14.18
 Blanking plug, TR2-TR3B 15.13
 Blanking plug, TR4-4A 15.14
 Body cavity grease 15.6
 Bolts 22.1
 ,Bomb type' starter motor 14.2
 Bonnet fastener 18.2
 Bonnet hinges,
 TR2 from TS4229, TR3-3B 18.2
 Bonnet hinges, TR2 to TS4228 . . . 18.1
 Bonnet hinges, TR4-4A 18.3
 Bonnet lock, TR2 to TS4228 18.1
 Bonnet prop rod, TR4-4A 18.3

Bonnet, TR2-3B 15.5
 Bonnet, TR4-4A 15.9
 Books 21.28
 Boot carpet, TR2-3B 20.13
 Boot floor, TR2-3B 15.8
 Boot floor, TR4-4A 15.12
 Boot lid hinges, TR2-TR3B 18.4
 Boot lid hinges, TR4-4A 18.5
 Boot lid, TR2-3B 15.5
 Boot lid, TR4-4A 15.9
 Boot lock, TR2-TR3B 18.4
 Boot lock, TR4-4A 18.5
 Boot mat, TR2-3B 20.13
 Boot rack 21.25
 Borg & Beck clutch kit 3.1
 Boss kit, Moto-Lita 21.14
 BPF bulb 14.25
 Brake caliper, front,
 Girling system 12.5
 Brake caliper, front,
 TR3 from TS13046 to TR4A 12.5
 Brake disc, front,
 Girling system 12.5
 Brake disc, front,
 TR3 from TS13046 to TR4A 12.5
 Brake disc, improved version . . . 21.17
 Brake disc, vented 21.17
 Brake drum, A-Fin 21.17
 Brake drum, rear,
 Girling system 12.7
 Brake drum, rear,
 Lockheed system 12.6
 Brake drum, rear,
 TR2-TR3 to TS13045 12.6
 Brake drum, rear,
 TR3 from TS13046 -
 TR3A to TS56376 12.7
 Brake fluid, AP Lockheed 3.3
 Brake hoses,
 stainless steel braided 21.17
 Brake hoses,
 TR2 - TR3 to TS13045
 (Lockheed system) 12.11
 Brake hoses,
 TR3A from TS13046 - TR4A
 (Girling system) 12.12
 Brake hoses, TR4A IRS 12.13
 Brake hoses, TR4A solid axle . . . 12.14
 Brake light switch 14.6
 Brake light switch,
 TR2 - TR3 to TS13045
 (Lockheed system) 12.11

- Brake light switch,
TR3A from TS13046 - TR4A
(Girling system) 12.12
- Brake light switch, TR4A IRS . . . 12.13
- Brake light switch,
TR4A solid axle. 12.14
- Brake master cylinder,
Girling system 12.2
- Brake master cylinder,
Lockheed system 12.1
- Brake master cylinder,
TR2, TR3 to TS3045 3.3
- Brake master cylinder,
TR2-3 to TS13045 12.1
- Brake master cylinder,
TR3 from TS13046. 12.2
- Brake master cylinder,
TR3 from TS13046, TR3A 3.4
- Brake pads front,
Girling system 12.5
- Brake pads front,
TR3 from TS13046 to TR4A 12.5
- Brake pads, competition 21.17
- Brake pads,
Kevlar 'Green Stuff' 21.17
- Brake pads, Mintex 21.17
- Brake pedal 12.3
- Brake pipe set,
TR2 - TR3 to TS13045
(Lockheed system) 12.11
- Brake pipe set,
TR3A from TS13046 - TR4A
(Girling system) 12.12
- Brake pipe set, TR4A IRS 12.13
- Brake pipe set,
TR4A solid axle. 12.14
- Brake servo for single line
braking system. 21.17
- Brake shoes rear,
Girling system 12.7
- Brake shoes rear,
Lockheed system 12.6
- Brake shoes rear,
TR2-TR3 to TS13045 12.6
- Brake shoes rear,
TR3 from TS13046 -
TR3A to TS56376 12.7
- Brake shoes rear,
TR3A from TS56377 - TR4A 12.8
- Brass nuts 22.1
- Brass screws 22.1
- Breather, crank case 21.9
- Brooklands aeroscreen 21.25
- BSF nuts 22.1
- BSF screws. 22.1
- Bulb holder 14.24
- Bulbs. 14.25
- Bulkhead, TR2-3B. 15.7
- Bulkhead, TR4-4A 15.11
- Bumper, stainless steel . . . 16.2, 21.25
- Bumpers, TR2-3 16.1
- Bumpers, TR3A-B 16.2
- Bumpers, TR4. 16.3
- Bumpers, TR4A. 16.4
- Button, Durable dot, TR2-3B 19.1
-
- C**
- C40 conversion kit 21.23
- Cable strap 14.24
- Cam follower 1.5
- Cam follower, competition 21.1
- Camshaft 1.3
- Camshaft, Kent. 21.1
- Canvas hoods and covers,
TR2 from TS5256, TR3-3B 20.16
- Canvas hoods and covers,
TR2 to TS5255 20.15
- Canvas hoods
and covers, TR4 20.17
- Canvas hoods
and covers, TR4A 20.18
- Canvas tonneau,
TR2 from TS5256, TR3-3B 20.16
- Canvas tonneau, TR4 20.17
- Canvas tonneau, TR4A. 20.18
- Car Cover. 21.32
- Carburettor balancer 6.1, 21.8
- Carburettor cleaner 6.4
- Carburettor damper oil 21.8
- Carburettor rebuilt kits 21.8
- Carburettor, SU-H4 6.1
- Carburettor, SU-H6 6.4
- Carburettor, SU-HS6 6.10
- Carburettor, Weber 21.8
- Carburettor, Zenith-Stromberg . . . 6.7
- Carpet set, TR2-3B 20.13
- Carpet set, TR4-4A 20.14
- Carpets adhesive 20.13
- Castrol Classic oil 21.31
- Castrol Classic pouring jug. 21.31
- Castrol damper oil 11.4, 21.31
- CD Rom with
technical publications 21.27
- Centre silencer, TR2-4 9.2
- Centre silencer,
TR4A to CTC70000 9.3
- Champion spark plug 14.4
- Champion spark plug cap 14.4
- Charger, battery 21.22
- Chassis frame, TR2-3B. 15.1
- Chassis frame, TR4 15.2
- Chassis frame, TR4A IRS 15.4
- Chassis frame, TR4A solid axle. . . 15.3
- Chassis plate, TR2 18.1
- Chassis plate, TR3, TR3A-3B 18.2
- Chassis plate, TR4-4A 18.3
- Chassis plates, all. 21.26
- Chassis, TR2-3B 15.1
- Chassis, TR4. 15.2
- Chassis, TR4A IRS. 15.4
- Chassis, TR4A solid axle 15.3
- Choke cable 5.1
- Chrome mouldings, TR2-3B 18.10
- Chrome polish, Luster Lace 16.1
- Chromed wire wheels 21.18
- Circuit testing lamp. 21.22
- Clikadjust. 21.30
- Clutch 3.1
- Clutch cover, uprated 21.4
- Clutch hose,
stainless steel braided 3.5, 21.4
- Clutch kit, Borg & Beck 3.1
- Clutch master cylinder,
TR2, TR3 to TS3045 3.3
- Clutch master cylinder,
TR3 from TS13046, TR3A 3.4
- Clutch master cylinder, TR4-4A . . . 3.5
- Clutch pedal. 3.2
- Clutch plate for
Getrag gearbox. 21.3
- Clutch release bearing,
reinforced roller type. 21.4
- Clutch slave cylinder,
TR2, TR3 bis TS3045. 3.3
- Clutch slave cylinder,
TR3 from TS13046, TR3A 3.4
- Clutch slave cylinder, TR4-4A 3.5
- Coil spring compressor 21.29
- Coil springs, front 21.15
- Coil springs, front TR2-4 8.1
- Coil springs, front TR4A. 8.4
- Coil springs, rear, TR4-4A. . . 11.4, 21.16
- Colortune. 21.30
- Colour samples for
interior trim and hoods 20.99
- Combination spanner set. 21.30
- Composite cylinder
head gaskets 21.2
- Con rod 1.3, 21.1
- Condenser, ignition system 14.3

Connolly leather care 20.1
 Contact set 14.3
 Control box, dynamo 14.6
 Control head, TR2-3B 14.9
 Conversion gasket set 1.2, 1.4
 Conversion kit
 to 4 pot calipers 21.17
 Conversion kit
 to narrow fan belt 4.4, 21.5
 Conversion kit to oil seal 21.1
 Conversion kit
 to shock absorbers 21.16
 Conversion kit to
 wire wheels 21.18
 Copper washers 22.1
 Copper/hide hammer 21.18
 Core plugs 1.5
 Countersunk screw 22.1
 County pistons 1.3
 Crank case 1.10
 Crank case breather 21.9
 Crankshaft 1.3
 Crown wheel and pinion,
 Girling rear axle 11.6
 Crown wheel and pinion,
 IRS axle 11.7
 Crown wheel and pinion,
 Lockheed rear axle 11.5
 Crown wheel and pinion,
 special ratios 21.16
 C-Tek battery charger 21.22
 Cylinder head 1.5, 21.2
 Cylinder head gasket,
 Composite 21.2
 Cylinder head gaskets 1.5
 Cylinder liner 1.3

D

Damper oil 11.2, 11.4, 21.31
 Dashboard, TR2-3B 14.10
 Dashboard, TR4 14.13
 Dashboard, TR4A 14.14
 Dashboards, all 21.24
 Differential carrier, Girling
 rear suspension 11.6
 Differential carrier, Lockheed
 rear suspension 11.5
 Differential, IRS axle 11.7
 Dipstick, engine 1.2
 Dipstick, gearbox TR2-3A 2.1

Disc wheel 13.1
 Distributor 14.3
 Distributor cap 14.3
 Distributor with improved
 advance curve 21.20
 Distributor, Lucas 14.3
 Distributor, Mallory 21.20
 Door glass, TR4-4A 19.2
 Door hinges, TR2, TR3-3B 18.6
 Door hinges, TR4-4A 18.7
 Door lock, TR2-3B 18.8
 Door lock, TR4-4A 18.9
 Door locks, TR3-3B 18.8
 Door locks, TR4-4A 18.9
 Door mirror, TR4-4A 19.5
 Door seal, TR2, TR3-3B 18.6
 Door seal, TR4-4A 18.7
 Door skin, TR2-3B 15.6
 Door skin, TR4-4A 15.10
 Door, TR2-3B 15.5
 Door, TR4-4A 15.9
 Down pipe, TR2-4 9.2
 Down pipe, TR4A from 70001 9.4
 Down pipe, TR4A to CTC70000 9.3
 Drive shaft, improved version 21.16
 Drive shaft, IRS axle 11.8
 Drivers handbook 21.27
 Dunlop tyres 21.18
 Durable dot button, TR2-3B 19.1
 Durable dot tool 20.17
 Dynamo 14.1
 Dzus fastener, bonnet 18.2
 Dzus fastener, side screen
 TR3A-3B 19.1

E

Electric fan, Kenlowe 21.5, 21.11
 Electronic ignition system 21.19
 Engine 1.1
 Engine conversion
 gasket set 1.2, 1.4
 Engine mounting 1.9
 Engine mountings 1.9
 Engine plate 1.4
 Exchange engines 1.1
 Exhaust manifold 9.1
 Exhaust pipe,
 TR4A from 70001 9.4
 Exhaust pipe,
 TR4A to CTC70000 9.3

Exhaust silencer, TR2-4 9.2
 Exhaust silencer,
 TR4A from 70001 9.4
 Exhaust silencer,
 TR4A to CTC70000 9.3
 Exhaust system, Phoenix 21.10
 Exhaust system,
 stainless steel 21.10
 Exhaust system, TR2-4 9.2
 Exhaust system,
 TR4A from 70001 9.4
 Exhaust system,
 TR4A to CTC70000 9.3
 Exhaust thermal wrap 21.10
 Exhaust valve 1.5
 Exhaust valve, stainless steel 21.2
 Expansion tank 4.2
 Eyelets 14.24

F

Facet petrol pump 21.7
 Fan belt, conversion kit
 to narrow fan belt 4.4, 21.5
 Fan blade, dynamo 14.1
 Fan blade, water pump 4.4
 Feeler gauge 21.30
 Fertan hood cleaner 20.15
 Fertan rust converter 15.7
 Fibre washer 22.1
 Filler cap, radiator, TR2-4 4.1
 Filler cap, radiator, TR4A 4.2
 Filter King petrol
 pressure regulator 21.7
 Filtermag 21.6
 Fire extinguisher 21.32
 First motion shaft,
 gearbox TR2-3A 2.2
 First motion shaft,
 gearbox TR3B-4A 2.4
 Fitting kit for oil cooler 21.6
 Flame-Thrower high performance
 ignition coil 21.19
 Flasher relay 14.6
 Flint 21.26
 Floor panel, TR2-3B 15.8
 Floor panel, TR4-4A 15.12
 Fluid Film rust-preventive 15.4
 Flywheel 1.3, 21.4
 Fog lamp 21.21
 Foot dipper switch,
 headlamp TR4-4A 14.12

- Foot dipper switch, headlamp,
TR2-TR3A 14.6
- Footwell carpets, TR4-4A 20.14
- Front shroud, TR2-3B 15.5
- Front suspension
shock absorbers, TR2-4 8.1
- Front suspension
shock absorbers, TR4A 8.4
- Front suspension,
rebuilt kit, TR2-4 8.2
- Front suspension,
rebuilt kit, TR4A 8.5
- Front valance, TR4-4A 15.9
- Fuel filler cap, TR2-3B 7.1
- Fuel filler cap, TR4-4A 7.2
- Fuel gauge, TR2-3B 14.8
- Fuel hose, per meter 21.7
- Fuel pipe, TR2-3B 7.3
- Fuel pipe, TR4 7.4
- Fuel pipe, TR4A 7.5
- Fuel pump, TR2-3B 7.3
- Fuel pump, TR4 7.4
- Fuel pump, TR4A 7.5
- Fuel regulator 21.7
- Fuel sender unit, TR2-3B 7.1
- Fuel sender unit, TR4-4A 7.2
- Fuel tank, aluminium 21.7
- Fuel tank, TR2-3B 7.1
- Fuel tank, TR4-4A 7.2
- Furflex door seal,
TR2, TR3-3B 18.6
- Furflex door seal,
TR4-4A 18.7
- Fuse box 14.6
- Fuses 14.6, 14.24
-
- G**
- Gas tester, Gunson's 21.8
- Gasket set, overdrive 2.5
- Gaz Shock absorbers, front 21.15
- Gaz Shock absorbers, rear 21.16
- Gear 2.2
- Gear knob, TR2-3A 2.1
- Gear knob, TR3B-4A 2.3
- Gear knob, woodrim 21.24
- Gear lever, TR3B-4A 2.3
- Gear oil 21.31
- Gear wrench 21.30
- Gearbox first motion shaft,
TR2-3A 2.2
- Gearbox first motion shaft,
TR3B-4A 2.4
- Gearbox gasket set, TR2-3A 2.1
- Gearbox gasket set, TR3B-4A 2.3
- Gearbox mainshaft, TR2-3A 2.2
- Gearbox mainshaft, TR3B-4A 2.4
- Gearbox mounting rubber 2.5
- Gearbox mounting rubber,
TR2-3A 2.1
- Gearbox mounting rubber,
TR3B-4A 2.3
- Gearbox oil, all 21.31
- Gearbox oil, Castrol 21.3
- Gearbox tunnel, TR2-3B 15.8
- Gearbox tunnel, TR4-4A 15.12
- Gearbox with ,A' type
overdrive 21.3
- Gearbox, TR2-3A 2.1
- Gearbox, TR3B-4A 2.3
- Getrag 5-speed gearbox 21.3
- GFK gearbox tunnel, TR4-4A 15.12
- Girling braking system,
brake master cylinder 12.2
- Girling braking system,
front brake caliper 12.5
- Girling braking system,
front brake disc 12.5
- Girling braking system,
front brake pad 12.5
- Girling braking system,
rear brake drum 12.7
- Girling braking system,
rear brake shoe 12.7
- Girling braking system,
rear wheel cylinder 12.7
- Girling rear suspension 11.6
- Glass panels, TR2-3B 19.1
- Glass panels, TR4-4A 19.2
- Glass spark plug 21.30
- Gliptone leather care 20.2
- ,Globe' medallion 21.26
- ,Globe' sticker, TR4-4A 18.3
- Glove box, TR2-3B 14.10
- Glove box, TR4 14.13
- Glove box, TR4A 14.14
- Green Stuff Kevlar
brake pads 21.17
- Grip pliers 15.11
- Grommets, TR2-TR3B 15.13
- Grommets, TR4-4A 15.14
- Grose jet 21.8
- Grose jet, SU-H4 6.3
- Grose jet, SU-H6 6.6
- Grose jet, SU-HS6 6.12
- Grose jet, Zenith Stromberg 6.9
- Gunson's carburettor balancer 21.8
- Gunson's klikadjust 21.30
- Gunson's colortune 21.30
- Gunson's gas tester 21.8
-
- H**
- ,H' beam con rod 21.1
- H4 carburettor 6.1
- H4 head lamp 21.21
- H6 carburettor 6.4
- Hadura boot mat, TR2-3B 20.13
- Half shaft, IRS axle 11.7
- Halogen bulb 14.25, 21.21
- Halogen headlamp 21.21
- Hammer, copper/hide 21.18
- Hand reamer for
throttle spindles 21.8
- Hand tap 21.30
- Handbooks 21.27
- Handbrake cable, TR2-4 12.9
- Handbrake cable, TR4A 12.10
- Handbrake lever, TR2-4 12.9
- Handbrake lever, TR4A 12.10
- Hardtop, TR2-3B 20.19
- Hardtop, TR4-4A 20.20
- Hazard warning kit 14.6, 14.12, 21.21
- Headlamp 14.18
- Headlamp bowl 14.18
- headlamp, foot dipper switch
for headlamp 14.6
- Heater matrix, TR2-3B 14.22
- Heater matrix, TR4-4A 14.23
- Heater motor, TR2-3B 14.22
- Heater motor, TR4-4A 14.23
- Heater rheostat, TR2-3B 14.9
- Heater, TR2-3B 14.22
- Heater, TR4-4A 14.23
- High performance
ignition coil 14.4, 21.19, 21.20
- High performance ignition
lead kit 21.19
- High performance
starter motor 14.2, 21.23
- High Port cylinderhead 1.5, 21.2
- Hinges, bonnet TR2
from TS4229, TR3-3B 18.2
- Hinges, bonnet TR2 to TS4228 18.1
- Hinges, bonnet TR4-4A 18.3
- Hinges, boot lid TR2-TR3B 18.4
- Hinges, boot lid TR4-4A 18.5
- Hinges, door TR2, TR3-3B 18.6
- Hinges, door TR4-4A 18.7
- Hood cleaner, Fertan 20.15

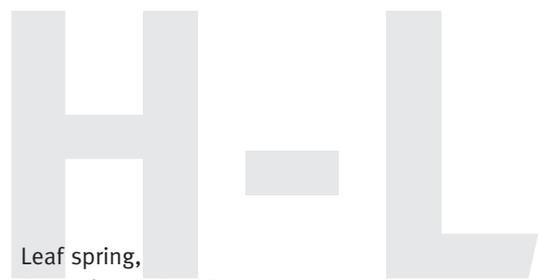

Hood frame covering kit, TR4 . . . 20.11
Hood frame covering kit,
TR4 from middle of 63 20.5
Hood frame covering kit,
TR4 to middle of 63 20.4
Hoods, hood covers
and hood frames,
TR2 from TS5256, TR3-3B 20.16
Hoods, hood covers
and hood frames,
TR2 to TS5255 20.15
Hoods, hood covers
and hood frames, TR4 20.17
Hoods, hood covers
and hood frames, TR4A 20.18
Horn 14.6
Hose clip 22.1
HS6 carburettor 6.10, 21.8
Hub cap 13.1
Hub, Girling rear suspension . . . 11.6
Hub, IRS axle 11.8
Hub, TR2-4 8.3
Hub, TR4A 8.6
Hydrometer 21.22
Hylomar 21.1

I
Ignition coil 14.4
Ignition lead 14.4
Ignition lead, silicone type . . . 21.20
Ignition switch and lock,
TR4-4A 14.12
Ignition system, electronic . . . 21.19
Ignition timing light 21.30
Imperial wrench 21.30
Indicator lever 14.9
Indicator, front 14.19
Inlet manifold 9.1
Inlet manifold, Weber 21.8
Inlet valve 1.5
Inlet valve, stainless steel 21.2
Inner sill, TR2-3B 15.6, 15.8
Inner sill, TR4-4A 15.10, 15.12
Inner wing, front, TR2-3B 15.7
Inner wing, front, TR4-4A 15.11
Inner wing, rear, TR4-4A 15.12
Instrument panel, TR4 14.13
Interior mirror, TR2-3B 19.4
Interior trim, TR2 20.7
Interior trim, TR3 20.8

Interior trim,
TR3A from TS 60001 to 3B 20.10
Interior trim, TR3A to TS60000 . . 20.9
Interior trim, TR4 20.11
Interior trim, TR4A 20.12
IRS axle 11.7

J
Jack 13.2, 21.29
Jaeger fuel gauge, TR2-3B 14.8
Jaeger oil pressure gauge,
TR2-3B 14.8
Jaeger oil pressure gauge,
TR4-4A 14.11
Jaeger speedometer, TR2-3B . . . 14.8
Jaeger speedometer, TR4-4A . . . 14.11
Jaeger tachometer, TR2-3B 14.8
Jaeger tachometer, TR4-4A 14.11
Jaeger temperature gauge,
TR2-3B 14.8
Jaeger temperature gauge,
TR4-4A 14.11

K
K&N air filter 21.9
K&N breather, crank case 21.9
Kenlowe electric fan 21.5, 21.11
Kent camshaft 21.1
Kevlar ,Green Stuff'
brake pads 21.17
Keys, TR2-3B 14.10, 18.8
Keys, TR4-4A 18.9
Koni shock absorbers,
front suspension 21.15
Koni shock absorbers,
rear suspension 21.16

L
Lamp, number plate 14.21
Lay shaft, TR2-3A 2.2
Lay shaft, TR3B-4A 2.4
Laygear, TR2-3A 2.2
Laygear, TR3B-4A 2.4
Laygear, uprated version 21.3
Lead linger for sealing 1.6
Leaf spring, lowered 21.16

Leaf spring,
TR2-4 from CT23383 11.2
Leaf spring,
TR2-4 to CT23382 11.1
Leaf spring, TR4A solid axle 11.3
Leather care 20.1, 20.2, 20.3
Leather care, Autoglym 20.3
Leather care, Swissvax 20.12
Leather seat covers, TR2 20.1
Leather seat covers, TR3 20.2
Leather seat covers, TR3A-3B . . . 20.3
Leather seat covers,
TR4 from middle of 1963 20.5
Leather seat covers,
TR4 to middle of 1963 20.4
Leather seat covers, TR4A 20.6
Leather seats, TR4 20.5
Leather seats, TR4A 20.6
Leatherrim steering wheel,
Moto-Lita 21.13
Lens head screw 22.1
Letters ,Triumph' on bonnet 18.3
Letters ,Triumph' on boot lid 18.5
Lift the dot screw 18.6
Light switch, side
and headlamps, TR2-3B 14.9
Limited slip differential 21.16
Liner for pistons 1.3
Lock, boot TR2-TR3B 18.4
Lock, door TR2-3B 18.8
Lock, door TR4-4A 18.9
Lockheed rear suspension 11.5
Lockheed system,
front wheel cylinder 12.4
Lockheed system,
master brake cylinder 12.1
Lockheed system,
rear brake drums 12.6
Lockheed system,
rear brake shoes 12.6
Lockheed system,
rear wheel cylinder 12.6
Long type starter motor 14.2
Low Port cylinder head 1.5
Lucar connector 14.24
Lucar terminals 14.24
Lucas Ammeter, TR2-3B 14.8
Lucas Ammeter, TR4-4A 14.11
Lucas distributor 14.3
Lucas H4 headlamp 21.21
Lucas high performance
ignition coil 14.4, 21.20

Lumenition ignition system 21.19
 Luster Lace chrome polish 16.1
 Luster Lace polishing strips 21.10

M

Magnetronic ignition system . . . 21.19
 Mahle pistons. 1.3, 21.1
 Main bearing, crankshaft 1.3
 Main jet, SU-H4 6.3
 Main jet, SU-H6 6.6
 Main jet, SU-HS6 6.12
 Mainshaft, gearbox TR2-3A 2.2
 Mainshaft, gearbox TR3B-4A 2.4
 Mallory distributor 21.20
 Manifold gasket 1.5, 9.1
 Medallion on bonnet,
 TR4, TR4A 18.3
 Medallion on front valance,
 TR2-3B 18.1, 18.2
 Medallions and scripts 21.26
 Metal polish, Autoglym 16.3
 Metal signs 21.26
 Metering needle, SU-H4. 6.3
 Metering needle, SU-H6. 6.6
 Metering needle, SU-HS6. 6.12
 Metering needle,
 Zenith Stromberg carburettor 6.9
 Michelin tyres. 21.18
 Mike Sanders body
 cavity grease 15.6
 Minator alloy wheels. 21.18
 Mirror 19.5
 Mirror, interior, TR2-3B 19.3
 Mirror, interior, TR4-4A. 19.4
 Mitex brake pads 21.17
 Mitsuba fuel pump 21.7
 Mohair hood and covers,
 TR2 from TS5256, TR3-3B 20.16
 Mohair hood and covers,
 TR2 to TS5255 20.15
 Mohair hood and covers,
 TR4. 20.17
 Mohair hood and covers,
 TR4A 20.18
 Mohair tonneau, TR2 from
 TS5256, TR3-3B 20.16
 Mohair tonneau,
 TR2 to TS5255 20.15
 Mohair tonneau, TR4. 20.17
 Mohair tonneau, TR4A. 20.18
 Moto-Lita boss kits. 21.14

Moto-Lita leatherrim
 steering wheel 21.13
 Moto-Lita woodrim
 steering wheel 21.12
 Mouldings, TR2-3B 18.10
 Mouldings, TR4-4A 18.11
 Mudflaps 21.32

N

Narrow fan belt
 conversion kit 4.4, 21.5
 NGK spark plug 14.4
 NGK spark plug cap 14.4, 21.20
 Number plate lamp. 14.21
 Nut splitter. 21.30
 Nuts 22.1
 Nylatron bushes for
 leaf spring 21.16
 Nylatron bushes,
 front suspension. 21.15
 Nyloc nuts 22.1

O

Octagonal spinner. 13.1, 21.18
 Oil cooler. 21.6
 Oil cooler fitting kit. 21.6
 Oil drip mat 21.32
 Oil filler cap 1.5
 Oil filter 1.6, 1.7, 1.8
 Oil filter adaptor, Purolator 1.6
 Oil filter adaptor, Tecalemit 1.8
 Oil filter head. 1.7
 Oil filter head, Purolator 1.6, 1.7
 Oil filter head, Tecalemit 1.8
 Oil filter mag 21.6
 Oil filter, element - paper. 1.6, 1.7
 Oil pressure gauge, TR2-3B 14.8
 Oil pressure gauge, TR4-4A 14.11
 Oil pressure valve. 1.6
 Oil pump 1.2
 Oil pump, uprated. 21.1
 Oil seal, crankshaft 1.4, 21.1
 Oil seal, gearbox TR2-3A 2.1
 Oil seal, gearbox TR3B-4A 2.3
 Oil seal, overdrive. 2.6
 Oil stat 21.6
 Oil sump 1.2
 Oil sump, aluminium. 21.1
 Oil, carburettor damper oil. 6.4

Oils 21.31
 On board tool kit 21.30
 Optronic ignition system 21.19
 Outer sill, TR2-3B 15.6
 Outer sill, TR4-4A 15.10
 Overdrive. 2.5
 Overdrive with gearbox 21.3

P

Panel light, TR2-3B. 14.9
 Panhead screws 22.1
 Payen cylinder head gaskets 1.5
 Pedal rubber, brake. 12.3
 Pedal rubber, clutch 3.2
 Pedal shaft. 12.3
 Pedal, accelerator pedal 5.1
 Pedal, brake. 12.3
 Pedal, clutch 3.2
 Penrite. 4.1, 21.5
 Penrite gear oil. 21.31
 Penrite oils. 21.31
 Pertronix ignition system 21.19
 Petrol hose, per meter. 21.7
 Petrol pipe, TR2-3B. 7.3
 Petrol pipe, TR4 7.4
 Petrol pipe, TR4A 7.5
 Petrol pump, Facet 21.7
 Petrol pump, Mitsuba 21.7
 Petrol pump, TR2-3B. 7.3
 Petrol pump, TR4 7.4
 Petrol pump, TR4A 7.5
 Petrol regulator. 21.7
 Petrol tank, aluminium 21.7
 Petrol tank, TR2-3B. 7.1
 Petrol tank, TR4-4A. 7.2
 Phoenix exhaust system 21.10
 Phoenix tubular manifold. 21.10
 Pillar, TR2-3B 19.3
 Piston rings 1.3
 Piston set 1.3
 Piston set, aluminium 21.1
 Pistons, County 1.3
 Pistons, Mahle 21.1
 Plastic cleaner 20.19
 Plastic gearbox tunnel, TR4-4A. 15.12
 Plate washers. 22.1
 Points (distributor) 14.3
 Polish, Swissvax 21.24
 Polyurethane bushes for
 leaf springs 21.16
 Polyurethane bushes,
 front bushes. 21.15

- Pouring jugs, Castrol Classic . . . 21.31
 Private lock set, TR2-3B 18.8
 Private lock set, TR4-4A. 18.9
 Prop rod for bonnet, TR4-4A . . . 18.3
 Propshaft 11.9
 Propshaft for Getrag gearbox . . . 21.3
 Puller for rear hub 21.29
 Pulley for crankshaft 1.3, 21.1
 Punch pliers 20.16
 Purolator oil filter head 1.6, 1.7
 Push rod 1.5
 Push rod, competition 21.1
-
- Q**
 Quaife limited slip differential . . 21.16
-
- R**
 Radiator grille, TR2-3B 17.1
 Radiator grille, TR4-4A. 17.2
 Radiator guard, TR4A IRS. 15.4
 Radiator guard,
 TR4A solid axle. 15.3
 Radiator hose. 4.3
 Radiator, aluminium 21.5
 Radiator, TR2-4. 4.1
 Radiator, TR4A 4.2
 Ram pipe for SU carburettors. . . 21.9
 Rear hard top screen, TR2-3B. . . 20.19
 Rear lamp 14.20
 Rear screen, surrey top
 TR4-4A. 20.20
 Rear seats, TR2 20.1
 Rear seats, TR3 20.2
 Rear seats, TR3A-3B 20.3
 Rear seats, TR4 from
 middle of 1963. 20.5
 Rear seats, TR4 to
 middle of 1963. 20.4
 Rear seats, TR4A. 20.6
 Rear shock absorber,
 TR2-4 from CT23383. 11.2
 Rear shock absorber,
 TR2-4 to CT23382. 11.1
 Rear shock absorber,
 TR4A solid axle. 11.3
 Rear silencer, TR2-4 9.2
 Rear silencer, TR4A from 70001 . . 9.4
 Rear silencer,
 TR4A to CTC70000 9.3
 Rear suspension IRS,
 shock absorber. 11.4
 Rear suspension, Girling 11.6
 Rear suspension, Lockheed 11.5
 Rear valance, TR2-3B 15.5
 Rear valance, TR4-4A. 15.9
 Rear view mirror. 19.5
 Rebuilt kit,
 front suspension TR2-4 8.2
 Rebuilt kit,
 front suspension TR4A. 8.5
 Redline Water Wetter. 4.1, 4.2
 Release bearing, clutch 3.1
 Release bearing, clutch,
 reinforced roller type. 21.4
 Remote control housing,
 TR2-3A. 2.1
 Remote control housing,
 TR3B-4A. 2.3
 Repair panels, front TR2-3B. . . . 15.7
 Repair panels, inner,
 front TR4-4A. 15.11
 Repair panels, outer, TR2-3B . . . 15.6
 Repair panels, outer, TR4-4A . . . 15.10
 Revolution wheels. 21.18
 Revolving punch pliers 20.16
 Rim band 13.1
 Ring gear, flywheel 1.3
 Rocker 1.5
 Rocker cover 1.5, 21.2
 Rocker cover gasket 1.5, 21.2
 Rocker shaft. 1.5
 Rocker shaft, roller tip type 21.2
 Rocker shaft, TR2-3B. 10.1
 Rotor arm 14.3
 Rubber mats, TR4-4A. 20.14
 Rust converter, Fertan 15.7
 Rust-preventive for
 cooling system 4.1
 Rust-preventive, Fluid Film. 15.4
-
- S**
 Screen wash, Autoglym 20.17
 Screws. 22.1
 Script on boot lid 18.5
 Script ,Triumph' on bonnet 18.3
 Script ,Triumph' on
 rear shroud 18.4
 Scripts and badges. 21.26
 Sealed Beam head lamp 14.18
 Sealing washers 22.1
 Seat belts 21.32
 Seats and seat covers, TR2 20.1
 Seats and seat covers, TR3 20.2
 Seats and seat covers,
 TR3A-3B 20.3
 Seats and seat covers,
 TR4 from middle of 63 20.5
 Seats and seat covers,
 TR4 to middle of 63 20.4
 Seats and seat covers, TR4A . . . 20.6
 Self tapping screws. 22.1
 Shakeproof washer 22.1
 Shock absorber conversion 21.16
 Shock absorbers, front TR2-4. . . . 8.1
 Shock absorbers, front TR4A 8.4
 Shock absorbers, Gaz, front. . . . 21.15
 Shock absorbers, Gaz, rear 21.16
 Shock absorbers, Koni, front 21.15
 Shock absorbers, Koni, rear. . . . 21.16
 Shock absorbers, rear IRS 11.4
 Shock absorbers,
 rear TR2-4 from CT23383. 11.2
 Shock absorbers,
 rear TR2-4 to CT23382 11.1
 Shock absorbers,
 rear TR4A rigid axle. 11.3
 Side lamp, front 14.19
 Side light, front 14.19
 Side screen fastener 19.1
 Side screen, TR2-3B 19.1
 Side window, TR3A-3B. 19.1
 Sill, TR2-3B 15.6
 Sill, TR4-4A 15.10
 Slotted nuts 22.1
 Smiths fuel sender unit 7.2
 Socket set 21.30
 Sofitten bulb 14.25
 Solenoid, overdrive. 2.5
 Solenoid, starter motor 14.6
 Sound deadening kit, TR2-3B. . . . 20.13
 Sound deadening kit, TR4-4A. . . . 20.14
 Spanner for oil filter plug 21.29
 Spare wheel tray, TR2-3B. 15.8
 Spare wheel tray, TR4-4A. 15.12
 Spark plug 14.4
 Spark plug cap 14.4, 21.20
 Spark plug wrench 21.30
 Spark plug, glass 21.30
 Speedograph air filter 21.9
 Speedometer pinion 2.5
 Speedometer, TR2-3B 14.8
 Speedometer, TR4-4A 14.11
 Spinners for wire wheels 13.1, 21.18

Spire nuts 22.1
 Split pin and clevis pin 22.1
 Spot lamp 21.21
 Spray, stainless steel. 17.2
 Spring washer 22.1
 Square key for boot lid,
 TR2-TR3B. 18.4
 Square key for side screens,
 TR3A-3B 19.1
 Stainless steel braided
 brake hoses 21.17
 Stainless steel braided
 clutch hoses. 21.4
 Stainless steel bumper . . . 16.2, 21.25
 Stainless steel
 exhaust system. 21.10
 Stainless steel
 exhaust system, TR2-4 9.2
 Stainless steel exhaust system,
 TR4A from 70001 9.4
 Stainless steel spray 17.2
 Stainless steel threshold plate . . 21.25
 Stalk, side and headlamps,
 TR4-4A. 14.12
 Starter battery 14.5, 21.22
 Starter motor 14.2
 Starter motor, high performance. 21.23
 Starter switch, TR2-3B. 14.9
 Starting handle. 13.2
 Steel nuts 22.1
 Steering box lube 21.31
 Steering box, TR2-3B. 10.1
 Steering column, TR2-3B 10.1
 Steering column, TR4-4A 10.4
 Steering lever, TR2-3B 10.1, 10.2
 Steering lever, TR2-4 8.3
 Steering lever, TR4A 8.6
 Steering rack 10.3
 Steering rack, conversion kit . . . 21.11
 Steering rack, TR4-4A 10.3
 Steering rod, TR2-3B. 10.2
 Steering rod, TR4-4A. 10.3
 Steering wheel 10.4, 21.12, 21.13
 Sticker. 21.26
 Stoneguard 21.21
 Stoneguard for oil sump, TR2-3B . 15.1
 Stoneguard for oil sump, TR4. . . 15.2
 Stoneguard for oil sump, TR4A. . 15.3,
 15.4
 Stoneguard for radiator, TR2-3B . . 15.1
 Stoneguard for radiator, TR4 . . . 15.2
 Stoneguard, rear wing, TR2-3B. . 18.10
 Stromberg carburettor 6.7
 Stub axle, TR2-4. 8.3

Stub axle, TR4A 8.6
 Stud kit, ARP 21.1, 21.2
 Studs. 22.1
 Stups. 21.9
 SU Air filter 21.9
 SU carburettor 21.8
 SU carburettor cleaner. 6.4
 SU carburettor, H4 6.1
 SU carburettor, H6 6.4
 SU carburettor, HS6 6.10
 Sun visor 21.25
 Sun visor, TR4-4A 19.4
 Supastrobe 21.30
 Surrey top, TR4-4A 20.20
 Swissvax leather care kit 20.12
 Swissvax wood polish 21.24

T

Tachometer, TR2-3B 14.8
 Tachometer, TR4-4A. 14.11
 Tank, TR2-3B 7.1
 Tank, TR4-4A 7.2
 Tecalemit oil filter head 1.8
 Temperature gauge, TR2-3B. . . . 14.8
 Temperature gauge, TR4-4A 14.11
 Tenax fasteners tool 20.15
 Tenax peg 18.6
 Tensioner, timing chain 1.3
 Terminal clamp 14.5
 Thermal transmitter,
 TR4-4A. 14.6, 14.11
 Thermal wrap, exhaust 21.10
 Thermostat. 4.3
 Thermostat for radiator 4.3
 Thor hammer 13.2, 21.18
 Threshold plate, aluminium . . . 21.25
 Threshold plate,
 stainless steel 21.25
 Threshold plate, TR2-3B 18.10
 Threshold plate, TR4-4A. 18.11
 Throttle disc, SU-H4 6.3
 Throttle disc, SU-H6 6.6
 Throttle disc, SU-HS6 6.12
 Throttle disc,
 Zenith-Stromberg carburettor 6.9
 Throttle linkage, SU-H4 6.2
 Throttle linkage, SU-H6 6.5
 Throttle linkage, SU-HS6 6.11
 Throttle linkage,
 Zenith-Stromberg carburettor 6.8
 Timing chain. 1.3
 Timing cover. 1.3

Toe board panel, TR4-4A 15.11
 Tonneau, TR2 from TS5256,
 TR3-3B 20.16
 Tonneau, TR2 to TS5255 20.15
 Tonneau, TR4 20.17
 Tonneau, TR4A 20.18
 Tool bag 13.2
 Tool kit 21.30
 Tool roll 13.2
 Tool, Durable Dot 20.17
 Torque wrench 21.30
 Transfer 21.26
 Transmission tunnel, TR2-3B . . . 15.8
 Transmission tunnel, TR4-4A . . . 15.12
 Triumph books 21.28
 ,Triumph' medallion on
 bonnet TR4, TR4A. 18.3
 ,Triumph' medallion on
 front valance
 TR2, TR3, TR3A, TR3B 18.1, 18.2
 Tubular manifold. 21.10
 Tubular manifold, Phoenix 21.10
 Tyres 21.18

U

UNC nuts 22.1
 UNC screws 22.1
 UNF nuts 22.1
 UNF screws 22.1
 Universal joint, propshaft. 11.9

V

Vacuum pipe 14.3
 Vacuum unit. 14.3
 Valve grinder 21.30
 Valve springs 1.5
 Vented brake disc. 21.17
 Vinyl care. 20.8
 Vinyl hoods and covers,
 TR2 from TS5256, TR3-3B 20.16
 Vinyl hoods and covers,
 TR2 to TS5255 20.15
 Vinyl hoods and covers, TR4 . . . 20.17
 Vinyl hoods and covers,
 TR4A 20.18
 Vinyl seat covers, TR2 20.1
 Vinyl seat covers, TR3 20.2
 Vinyl seat covers, TR3A-3B. 20.3
 Vinyl seat covers, TR4 from
 middle of 63 20.5

Index

- Vinyl seat covers, TR4 to middle of 63 20.4
Vinyl seat covers, TR4A 20.6
Vinyl tonneau,
TR2 from TS5256, TR3-3B 20.16
Vinyl tonneau,
TR2 to TS5255 20.15
Vinyl tonneau, TR4 20.17, 20.18
Voltage stabilizer, TR4-4A. 14.11
Vredestein tyres 21.18
-
- W**
- Washer bottle for
windscreen wiper 14.17
Washer pump 14.17
Washers 22.1
Water drain tap,
cylinder block. 1.4
Water drain tap,
radiator TR2-4 4.1
Water drain tap,
radiator TR4A 4.2
Water pump 4.4
Water pump, aluminium 21.5
Water Wetter 4.1, 4.2
Weber carburettor 21.8
Wheel 13.1
Wheel arch, front, TR4-4A 15.11
Wheel arch, rear, TR2-3B 15.8
Wheel arch, rear, TR4-4A 15.12
Wheel bearing, IRS axle. 11.8
Wheel bearing, TR2-4 8.3
Wheel bearing, TR4A. 8.6
Wheel cylinder, front,
TR2-3 to TS13045 12.4
Wheel cylinder, front,
Lockheed system 12.4
Wheel cylinder, rear,
Girling system 12.7
Wheel cylinder, rear,
Lockheed system 12.6
Wheel cylinder, rear,
TR2-TR3 to TS13045 12.6
Wheel cylinder, rear,
TR3 from TS13046 -
TR3A to TS56376 12.7
Wheel cylinder, rear,
TR3A from TS56377 - TR4A 12.8
Wheel spacers 21.18
Wheels 13.1
Wheels, Revolution 21.18
Wind wings 21.25
Window glass, TR2-3B. 19.1
Window glass, TR4-4A. 19.2
Window regulator, TR4-4A 19.2
Windows, TR2-3B 19.1, 19.3
Windows, TR4-4A 19.2, 19.4
Windscreen wiper 14.17
Windscreen, TR2-3B 19.3
Windscreen, TR4-4A 19.4
Wing cover. 21.32
Wing mirror 19.5
Wing, TR2-3B 15.5
Wing, TR4-4A 15.9
Wiper arm 14.16
Wiper blade 14.16
Wiper motor. 14.15
Wire wheel hub,
Girling rear axle 11.6
Wire wheel hub,
IRS axle 11.8
Wire wheel hub,
Lockheed rear axle 11.5
Wire wheel hub, TR2-4 8.3
Wire wheel hub, TR4A 8.6
Wire wheels 13.1, 21.18
Wire wheels conversion kit 21.18
Wiring loom 14.7
Wishbone, TR2-4 8.2
Wishbone, TR4A 8.5
Wood polish, Swissvax 21.24
Woodrim dashboard, TR2-3B 14.10
Woodrim dashboard, TR4 14.13
Woodrim dashboard, TR4A. 14.14
Woodrim dashboards, all. 21.24
Woodrim gear knob 21.24
Woodrim steering wheel,
Moto-Lita 21.12
Workshop Manual. 21.27
Wrench 21.30
Wrinkle paint 14.10
-
- Y**
- ,Y' exhaust pipe,
TR4A from 70001 9.4
,Y' exhaust pipe,
TR4A to CTC70000 9.3
-
- Z**
- Zenith Stromberg carburettor 6.7
Zinc spray 15.5

