

# **Installation Manual**

---

**1963-68 Jaguar S-TYPE**  
**1966-68 Jaguar 420**

*Left Hand Drive*

# ***Congratulations...***

**You have just purchased the highest quality, best performing A/C system ever designed for your 1948-54 Jaguar XK 120.**

To obtain the high level of performance and dependability our systems are known for, please pay close attention to the following instructions. Our installation steps and procedures are derived from a long history of research and development and the combined experience achieved thru thousands of successful installations (and feedback from customers like you). Please remember that our #1 goal is that you'll have a successful installation and a system that performs at a very high level for many years to come.

Before starting, read the instructions carefully, from beginning to end, and follow the proper sequence. On the next page you'll find a safety and general checklist that you should read before starting your installation.

Again, thank you from our entire staff.

## Check List, Pre-Installation:

- Before beginning the installation check the shipping box for the correct components. YOUR BOXED UNIT INCLUDES A LIST OF MAJOR COMPONENTS AND A LIST OF BAGGED PARTS. We have a 5 stage check process to make sure you have everything you'll need.
- If your vehicle has been or is being modified, some procedures will need to be adjusted to fit your particular application.**
- A basic cleaning of the engine compartment and interior before beginning will make things go more smoothly.
- Check condition of engine mounts. Excessive engine movement can damage hoses to A/C and/or heater.
- Before starting, check vehicle interior electrical functions (interior lights, radio, horn, etc). Make a note of anything that does not work as it's supposed to. During the installation you might find the opportunity to repair or upgrade non-working or out of date components. When you're ready to start the installation, **DISCONNECT THE BATTERY FIRST.**
- SAFETY FIRST: Wear eye protection while drilling/cutting, deburr sharp edges, and never get in a hurry or force a part.
- Tools: Your installation only requires the basic tools everyone has in their garage, nothing exotic or specific to A/C or Heat equipment.

## Procedures, During Installation:

- Fittings: Use one or two drops of mineral oil (supplied with your kit) on ALL rubber o-rings, threads and rear of bump for o-ring where female nut rides. Do not use thread tape or sealants.
- Measure twice (or more), cut once
- Should you have any technical questions, or feel you have defective components (or missing items), call us immediately, we will be glad to assist you. Our toll-free number is listed on every page, we're here to help!**

***YOU CAN NOW BEGIN THE INSTALLATION...***

## A Basic Overview of Automotive A/C....

- 1 Evaporator with Blower Fan** In order to remove the heat from the air in the vehicle, the A/C evaporator allows the refrigerant to absorb the heat from the air passing over it. The blower fan moves cool air out into the car interior.
- 2 Compressor** The compressor pumps and circulates the refrigerant through the system.
- 3 Condenser** The condenser is a heat exchanger mounted at the front of the vehicle. Heat drawn out of the interior of the car is expelled here.
- 4 Receiver/Drier** The drier not only dries refrigerant, it also filters the refrigerant and stores it under certain operating conditions.
- 5 High Pressure Switch** A pressure switch is used to shut down the system if high or low pressure is detected, basically it acts as a safety switch.

The air conditioning system in your car is comprised of a compressor, condenser, expansion valve, receiver/drier, and evaporator. Refrigerant (also known as Freon) is compressed in the compressor. In the condenser, gas is cooled to a liquid state and travels to the expansion valve. As the liquid refrigerant goes through the expansion valve it rapidly cools in the evaporator. A fan blows over the evaporator and cools the air that blows out your vents.

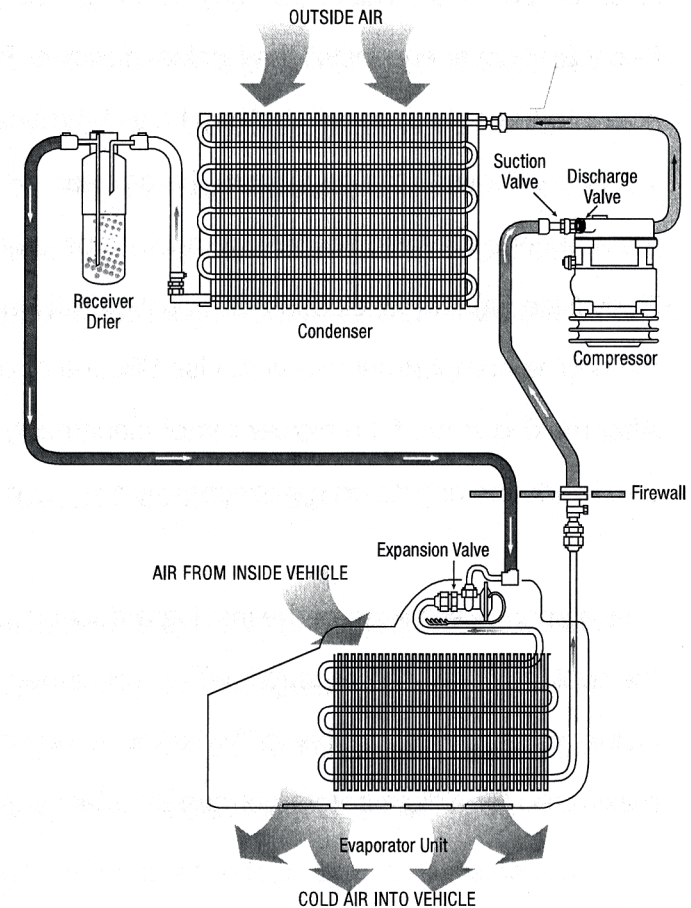

After removal of the battery, battery tray, Right Battery Tray Brace, passenger carpeting and lower dash trim panel, remove the RH Pedal Box cover and install the Enclosed Blower Reinforcement Plate from inside the Engine Compartment. Bolt the bottom plate hole into the corresponding bottom hole in the body. Trace the opening and cut out the body to match, so the Blower, mounted inside the car (with the opening to the car rear) will have the correct size for maximum airflow. The other holes in the plate match the mounts on the Blower and will need to be drilled in the Body. The Plate must then be made to conform to the Bend on the Body (Bend it). The enclosed ABS Plastic Oval Hose Inlet can then be drilled to match the Plate holes- this part is mounted inside the engine compartment as well. Use Silicone or other sealer under the plate and Blower Mounting Plate surface for a good seal. After making sure of the blower motor placement, attach the Blower inside the car (with opening to the rear) with the Oval inlet on top, inside the engine compartment.

The interior plastic hose of the Insulated duct hose can be attached in the Engine Compartment at this time by forming it around the oval Blower Outlet; secure it with the included 3 washers/screws and Tie Wrap and seal edges with silicone sealer. The included Insulated Hose has a "Mylar" covering and needs to be protected from high heat! (Be sure that blower opening is maximized for airflow before permanent attaching)

Do not substitute evaporator hardware- it can cause damage!!

The evaporator is shipped with one cover loosely fitted (will be installed later). To mount the evaporator, place this cover on the firewall horizontally, sharp edges out, where the battery formally was. Place the left (drivers) side of the cover, past the edge of the right (pass) edge of the center raised panel to which the VIN information plate is attached. The top of the cover should be 1-1/2 inches from the underside of the horizontal cowl overhang. Make sure that the front cover is level and lined up, then drill two 3/32 inch holes on both right and left upper sides (away from the 2 inch holes about to be drilled) to secure the cover to the firewall temporarily with screws.

**INSURE THE EVAPORATOR HAS PROPER CLEARANCES INSIDE & OUT!**

Before drilling four- 2" holes with a hole saw through the cover and firewall, remove the 1-1/2" paper defroster hose and duct tape the end to prevent the hose from splitting. Add the supplied rubber section and adapter. Space these four (4) holes fairly equal to maximize airflow! It should be easier to space if smaller, pilot holes are drilled first. After cutting the four holes, remove the cover, and seal the small mounting holes with silicone. Use included foam weatherstrip to seal firewall depressions under the mounted evaporator. Clean/trim all hole edges and place the four- 2" outlets inside the cover with a sealing or PVC adhesive, then put cover on evaporator with supplied screws after drilling (the Firewall holes will have to be filed to accept the Hose adapters). Don't invert cover or holes will not line up!

Remove cover from Firewall and mount to the Evaporator case with included screws.

Trim Insulation as necessary and use silicone to fill any spaces in evaporator case joints. The outlets will protrude out from the cover and into the firewall holes. Mount the evaporator with supplied evaporator brackets and 1/4X1/2 Bolts and flat washers. After insuring that the assembly and brackets are level and outlets fully inserted, drill 3 holes (3/32") in the firewall for each bracket and attach with supplied screws. The evaporator must be firmly against the firewall! This would be the time to drill a 1 1/4" hole in the inner fender for the enclosed grommet that allows the A/C hose to pass through. (This should be done prior to permanently mounting evaporator so the hose lines up with the connection).

It may be easier if the duct hoses were also attached before mounting the Evaporator! Prior to moving inside the car, manipulate the insulated intake hose (attached to the blower motor) past all engine obstructions, bending and forming it, but maintaining maximum airflow up to the oval intake on the evaporator- cut off any excess. At this time, attach the inner Duct hose to the evaporator (if not already done) with the supplied Nylon ties and seal edges with silicone. The outer, insulation w/ covering will then be secured with the enclosed Foil Tape. Once the evaporator has been securely attached, drill a hole, from inside the car, for the Thermostat Switch capillary tube and grommet through the firewall and the cover. The hole should be between the 2nd and 3rd outlet leaving enough space to attach the duct hose -Do not penetrate too far or you could damage the evaporator coil!

It is important to reduce the glove box interior or there will not be sufficient room for this installation. A Mark II box is not as deep, so the stock box can be modified to the Mark II dimensions. Remove the Parcel Shelves for easier access and determine the location of the 4 Louver Vents on the Parcel Shelf rear wall, mark and drill 2" holes with a Hole Saw and install the louver Vents. Duct tubing may have to be shaped into an oval to reach the drivers side and should be attached to the Vents before replacing the shelves. Since some cars are different, you should determine the route of the hoses before you start. The under-dash material can be finished similar to the Mark II under dash passenger panel is done for professional results- see below. The switch panel may be used to house the switches.

Route the capillary tube of the temperature switch through the hole (with grommet) previously drilled and push halfway into evaporator coil. This is a judgment call- the coil takes up approx. one half of the case. It should go in a few inches before meeting light resistance. Once resistance is met, push it in another 2-1/2 inches unless too much resistance is felt, pull out and try again in a slightly different location. This tube senses the temperature of the air coming in and switches the compressor on and off as needed. When routing the tube from the switch, make every effort to keep the tube from touching any metal or ducts which may affect the temperature sensing. Don't crimp this tube!

Attach the previously cut duct hose to the 3 left side firewall evaporator outlets using the enclosed short tie wraps. Be sure these joints are secure and tight as the efficiency of the unit depends on this.



The Wiring harness has 5 electrical connectors on one end- connect as follows: Black to "B" on the Fan Switch, Red to "M", Yellow to "L", Orange to "H". The remaining Blue wire is connected to either side of the Thermostatic Switch. The other end of the long blue wire goes either side of the Drier Hi-Lo Switch. The short Blue wire goes from "C" on the Fan Switch to the other thermostat connector. Test with Motor Connected! The Switch Letters are small and confusing!

Install one of the snap-apart wire connectors on the free compressor wire and the mate to a length of supplied 12 ga wire which is routed in front of the radiator to the other wire on the Drier Hi/low pressure switch wiring harness.

Establish a connection to the ignition switch with the included length of Black wire, so it is "live" when the switch is on and "dead" when the switch is off. Connect this wire to the supplied circuit breaker at "AUX" terminal on the Circuit Breaker. For either ground- attach the Black large harness wire to the circuit breaker terminal "BAT". To use the Relay for the Condenser fan, route the correct fan wire to the Relay # "87". #30 gets connected to a battery source, # 86 gets connected to the "C" post on the Fan switch sharing that position with the short blue wire. It can also be connected to switch under the dash to aid in cooling when the a/c is not on. #85 goes to ground. Route all the wires out of the way of obstructions that may develop when the dash and ducts are put together. Make sure all connections are good and hook up the harnesses and switches. Connect the battery and turn on the ignition to test the motor. When switched on, the motor should draw air from the passenger compartment and blow vigorously through the upper louvers. If not, something may be wired incorrectly.

Place battery and box on right side (passenger) of trunk (boot). Position it the best way to retain access to the jack stand and mark trunk floor where battery cables should come through from under the car and check underneath to insure there are no obstructions. Be mindful of the fuel lines and suspension travel. Drill (2) holes next to each other and fit the supplied grommets. Mark and drill the battery tray holes as well. It is important that you match the + or - terminals to the battery in the trunk! Does the car have positive or negative ground? Keep track! In the engine compartment, remove the old battery cables and insure that there is a good ground connection from the engine to the car frame. Crimp and/or solder an "eye" cable connector to one end of cable supplied and connect that to the old battery cable's position on the firewall mounted solenoid. Feed the cable down under the car along the right "frame rail". From under the car, space out and drill 6- holes along the frame rail (avoiding other lines already there) hanging the cable with the supplied hangers and screws.

Feed the cable through one of the drilled holes and calculate where to cut the cable to fasten to the battery and terminal. The end of the long cable will now need the appropriate + or- terminal to be crimped and/or soldered on. Do the same to an "eye" for the short cable end and insert in the remaining hole and attach to the frame with the enclosed self-tapping bolt. That cable now gets cut to length and the remaining terminal is crimped and/or soldered on. Do not connect the battery until all A/C wiring is done!

With grille removed, measure 13" from bottom pan on right (Passenger) side grille opening wall and mark. At the same height, measure 1" forward from the radiator support/brace. Check for clearance and interference on both sides of Grille wall! These intersecting marks will be the center of a 1 1/4" diameter hole in the side panel to gain access to the R/F wheel opening. Drill another 1 1/4" hole 9 3/4" below the first one. Fit the enclosed grommets into these holes after treating raw edges with rust preventive. The top hole/connection will be the large inlet, while the lower hole/connection will be the smaller outlet. Make sure the condenser connections or A/C hoses will not chafe on metal. Loosely mount the condenser so it will be next to the right (passenger) side of the grille opening where the holes were just made. Install the Condenser Fan at this time. The condenser fittings should be accessible for attachment to the A/C hoses upon completion of this section.

**The condenser should be at least 1" away from the radiator!!**

With the radiator removed and the condenser installed, remove the fan belt and fan blade. Remove the inverted 5/16" head nut and stud directly above the center generator bracket bolt. Rear Bracket is "S" shaped Bracket that is mounted to the new longer inverted stud only. Parts are Laser cut, but not Computer bent so some adjustments may be needed. Do not tighten at this time. The front bracket is installed with the supplied 5/16-24X3" bolts/washers in the upper outermost holes in the front timing chain cover (just below the head). Remove any bolts already there. If your generator adjustment bracket is anchored to one of these, you may need a longer bolt In "Grade 8". Leave all the bolts on the brackets somewhat loose and install the compressor with the three bolts supplied (head of bolts should be against the compressor ears and the lock washers/nuts against the steel bracket). If the compressor pulley/clutch has less than one inch of clearance to the inner fender, it will be necessary to "dimple" the inner fender to give the proper clearance prior to mounting compressor. (The engine can torque to the left in reverse, therefore it is important that all motor mounts be in excellent condition to maintain sufficient clearances between inner fender and forward between fan and radiator). See Last Page for Back Idler Pulley Instructions! Before final fitting of the compressor, install the Heat Shield (after cutting and fitting) and tighten the bolts followed by the bracket bolts- make sure the compressor "T"(90 deg w/Svc Port) fittings are fitted, and transfer covers to the new fittings. Prior to mounting the Radiator and fan, cut 1/4 to 5/16th-inch deep section, approximately 4-6 inches long (see photos) from fan shroud edge to accommodate protruding compressor clutch and pulley. Now make a "dry run" radiator installation to check your clearances- be careful not to damage radiator fins! Check for top end clearance. Leave the fan belt loose to be tightened after radiator and shroud is installed. After rechecking, install Radiator and shroud. Seal all open spaces around the shroud and grille opening with heat resistant foam rubber or seal. This is to direct all air entering the grille opening to pass through the condenser and radiator and all the air pulled through the radiator exits through the shroud rear opening. Tighten fan belt until the belt deflects approximately 1/2 inch. This will need to be re-checked after 100 miles of operating.

**Remove covers only at connection time and O-Rings must be used and lubricated on each hose connection!!**

There are 4 A/C hoses with your kit. **RA-00004-07** with the Straight fitting is attached to the large compressor fitting and hand tightened. **RA-00004-06**, from the Compressor will need a 1 ¼" hole and supplied grommet in the inner fender near the small hose 1 ¼" Hole and grommet for the small hose leading from the evaporator Expansion valve. Connect the straight end of RA-00004-06 to the compressor by hand and the rest through the hole- the 45° end goes through the inner fender and gets connected to the upper, large fitting of the condenser. Use enclosed hangers to route correctly. The straight fitting of **RA-00004-04** goes through the other inner fender hole by the evaporator to the Drier mounted under the fender. **RA-00004-05** connects to the front fitting of the Receiver/Drier (arrow or IN points to Condenser) with the other end attaching to the bottom Condenser fitting, being sure the Hi-Lo Pressure Switch is facing out.

Be sure there are no obstructions or Tire clearance problems for the drier bracket and screws and attach. Attach the Drier wiring harness and feed it into the engine compartment using an existing hole or make a new one.

Hose Insulation: After hose installation, cut insulation to size for hose protection against extreme heat (exhaust manifold), and cut lengthwise to slip over hose. Use enclosed Aluminum Tape to cover slit lengthwise, which should be away from heat source.

Once it is wired up correctly, connect Refrigerant hoses using lubricated "O" rings, as the system will need to be evacuated for approximately one to three hours and charged with R134a refrigerant. Before charging the system, you may have to use a "jumper" wire to connect the Hi/Lo pressure switch harness terminals. The system should take approximately 12 to 14 oz of R134a refrigerant. This can be done at your local A/C garage as they will recognize the proper pressures for the most efficient cooling. Look for 200 to 225 psi hi press @ 90 to 95 deg Ambient Temp, and 25-35 low pressure. You should obtain temperatures of 37 to 42 degrees F at the louvers depending on the outside temperature, while maintaining good engine cooling. This is, of course, dependant on the installation of the A/C Kit and condition of the cooling system.

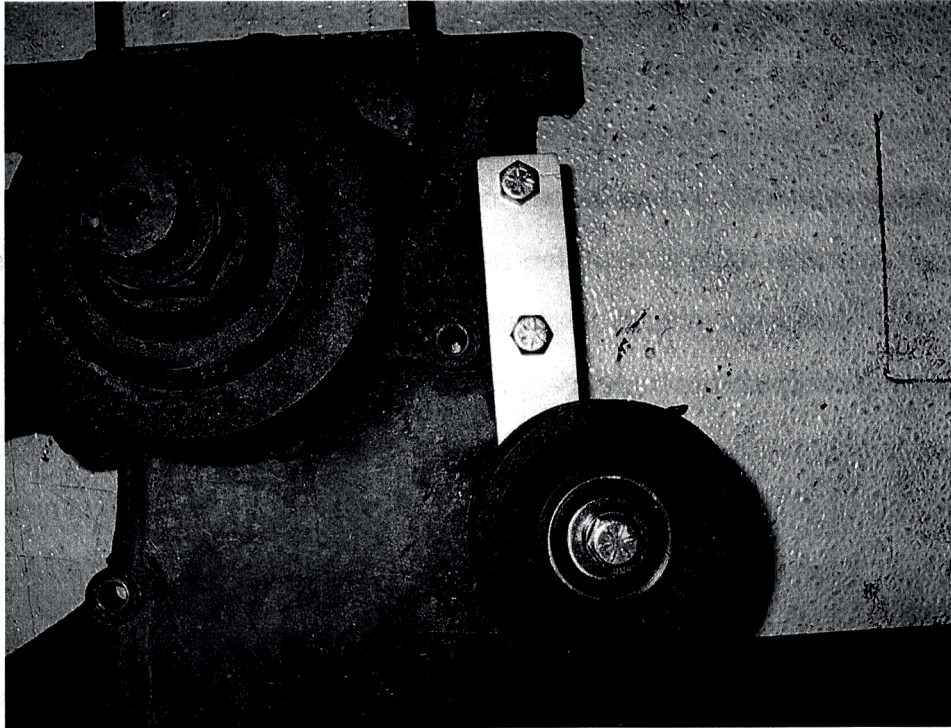
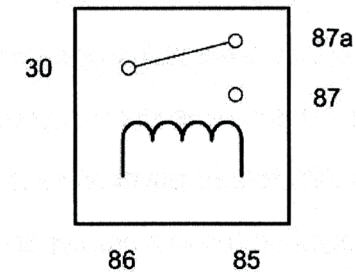
**Idler Pulley Kit**Relay Wiring Guide and  
Terminal Numbers

- 30 - High Power Feed (Must be Fused!)
- 85 - Relay Coil Ground
- 86 - Relay Coil Feed (Trigger Wire)
- 87 - High Power Output - Normally Open Contact
- 87a - High Power Output - Normally Closed Contact

It will be necessary to remove the Radiator and Fan Blade. Remove the Bolt (see pictures). The back of the belt rides on the idler pulley and goes down to the Crankshaft on the Right side and comes up & over the Water pump pulley on the Left side, to the Compressor, down to the Generator/Alternator to make the complete loop.

**WIRING DIAGRAM**

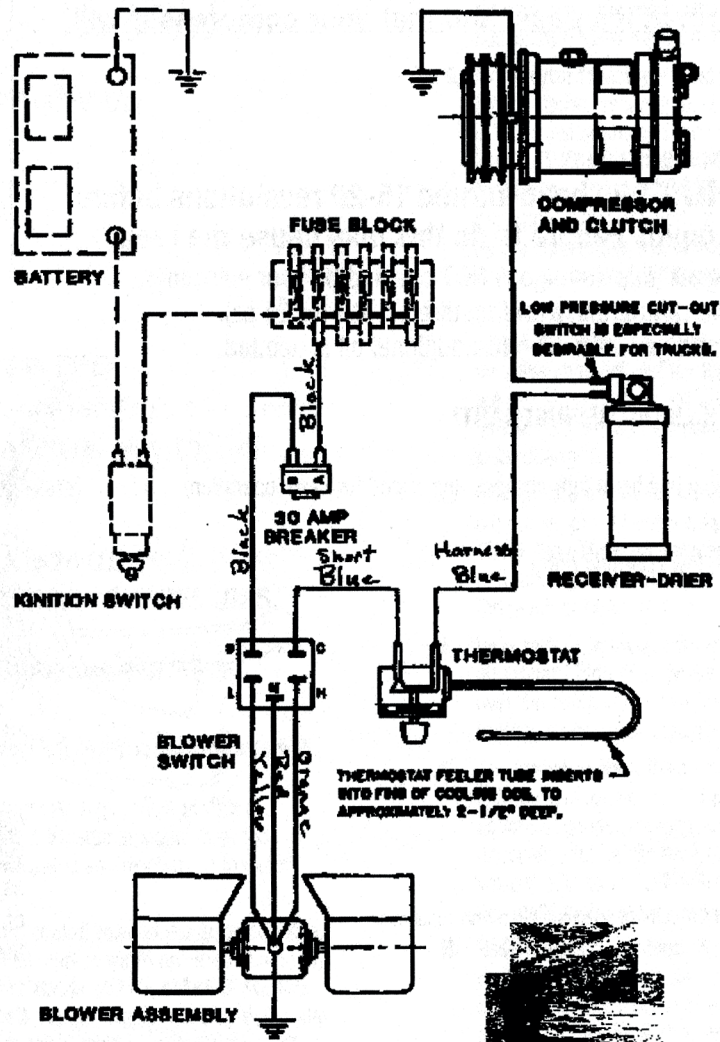



## New A/C System Preparation... A MUST READ!

Please read thru these procedures before completing this new A/C system charging operation.

**A licensed A/C technician should be utilized for these procedures to insure that your new system will perform at it's peak, and that your compressor will not be damaged.**

- 1) Evacuate the system for 45 minutes (minimum).
- 2) **Your new compressor *MUST* be hand-turned 15-20 revolutions before and after charging with liquid. Failure to do this may cause the reed valves to become damaged** (this damage is NOT covered by your warranty).
- 3) Your new system requires 134a refrigerant. It will require 1.5 lbs (or 24 oz).
- 4) Your new compressor comes charged with oil - NO additional oil is needed.
- 5) Insure that the new belt is tight.
- 6) **DO NOT CHARGE SYSTEM WITH LIQUID REFRIGERANT!**

**RECOMMENDED TEST CONDITIONS:** (After system has been fully charged and tested for basic operation)

- Determine the temperature outside of the car
- Connect gauges or service equipment to high/low charging ports
- Place blower fan switch on medium
- Close all doors and windows on vehicle
- Place shop fan directly in front of condenser
- Run engine idle up to approx. 1500 Rpm

**ACCEPTABLE OPERATING PRESSURE RANGES:**

1. HIGH-SIDE PRESSURES (150-275 PSI)
2. LOW-SIDE PRESSURES (10-25 PSI in a steady state)

Readings above are based on an ambient temperature of 90° with an adequate airflow on condenser

CENTERLINE OF THE OIL FILL BOLT

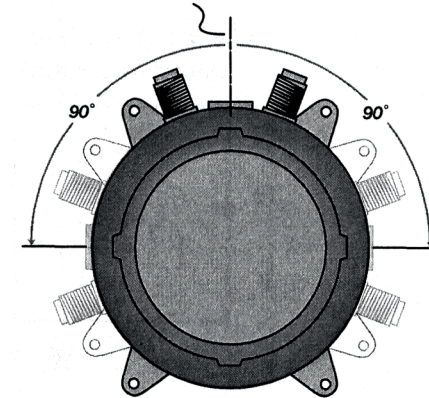

When mounting your compressor and/or adjusting the belt, Set compressor at 90 degrees.

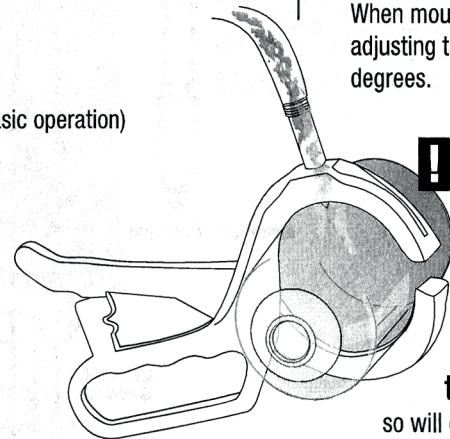

**Do NOT tilt, shake or turn refrigerant can upside-down OR use a charging station to install refrigerant while the engine is running.** Doing

so will direct liquid refrigerant into the compressor piston chamber, causing damage to reed valves and/or pistons and/or other components, as well as potentially seizing the compressor. Allow a minimum of 30 minutes for liquid to "boil off." You must hand turn the compressor hub (not the pulley) a minimum of 15 complete revolutions prior to starting the engine with the clutch engaged.

## TROUBLESHOOTING GUIDE

### TEST CONDITIONS USED TO DETERMINE SYSTEM OPERATION

(THESE TEST CONDITIONS WILL SIMULATE THE AFFECT OF DRIVING THE VEHICLE AND GIVE THE TECHNICIAN THE THREE CRITICAL READINGS THAT THEY WILL NEED TO DIAGNOSE ANY POTENTIAL PROBLEMS).

- B. CONNECT GAUGES OR SERVICE EQUIPMENT TO HIGH/LOW CHARGING PORTS.
- C. PLACE BLOWER FAN SWITCH ON MEDIUM.
- D. CLOSE ALL DOORS AND WINDOWS ON VEHICLE.
- E. PLACE SHOP FAN IN FRONT OF CONDENSER.
- F. RUN ENGINE IDLE UP TO 1500 RPM.

### ACCEPTABLE OPERATING PRESSURE RANGES (R134A TYPE)

1. HIGH-SIDE PRESSURES ( 150-275 PSI ) *\*Note- general rule of thumb is two times the ambient (daytime) temperature, plus 15-20%.*
2. LOW-SIDE PRESSURES ( 10-25 PSI in a steady state).

**CHARGE AS FOLLOWS: R134A = 24 OZ.**

**NO ADDITIONAL OIL IS NECESSARY IN OUR NEW COMPRESSORS.**

### TYPICAL PROBLEMS ENCOUNTERED IN CHARGING SYSTEMS

**NOISY COMPRESSOR.** A noisy compressor is generally caused by charging a compressor with liquid or overcharging

- A. If the system is overcharged both gauges will read abnormally high readings. This is causing a feedback pressure on the compressor causing it to rattle or shake from the increased cylinder head pressures. System must be evacuated and re-charged to exact weight specifications.
- B. **Heater control valve installation** - Installing the heater control valve in the incorrect hose. Usually when this occurs the system will cool at idle then start to warm up when raising the RPM's of the motor. **THE HEATER CONTROL IS A DIRECTIONAL VALVE; MAKE SURE THE WATER FLOW IS WITH THE DIRECTION OF THE ARROW.** As the engine heats up that water transfers the heat to the coil, thus overpowering the a/c coil. A leaking or faulty valve will

have a more pronounced affect on the unit's cooling ability. Installing the valve improperly (such as having the flow reversed) will also allow water to flow through, thus inhibiting cooling. Check for heat transfer by disconnecting hoses from the system completely. By running down the road with the hoses looped backed through the motor, you eliminate the possibility of heat transfer to the unit.

- C. **Evaporator freezing** - Freezing can occur both externally and internally on an evaporator core. External freeze up occurs when the coil cannot effectively displace the condensation on the outside fins and the water forms ice (the evaporator core resembles a block of solid ice), it restricts the flow of air that can pass through it, which gives the illusion of the air not functioning. The common cause of external freezing is the setting of the thermostat and the presence of high humidity in the passenger compartment. All door and window seals should be checked in the event of constant freeze-up. A thermostat is provided with all units to control the cycling of the compressor.
- D. **Internal freeze up** occurs when there is too much moisture inside the system. The symptoms of internal freeze up often surface after extended highway driving. The volume of air stays constant, but the temperature of the air gradually rises. When this freezing occurs the low side pressure will drop, eventually going into a vacuum. At this point, the system should be checked by a professional who will evacuate the system and the drier will have to be changed.
- E. **Inadequate airflow to condenser** - The condenser works best in front of the radiator with a large supply of fresh air. Abnormally high pressures will result from improper airflow. Check the airflow requirements by placing a large capacity fan in front of the condenser and running cool water over the surface. If the pressures drop significantly, this will indicate the need for better airflow.
- F. **Incorrect or inadequate condenser capacity** - Incorrect condenser capacity will cause abnormally high head pressures. A quick test that can be performed is to run cool water over the condenser while the system is operating, if the pressures decrease significantly, it is likely a airflow or capacity problem.
- G. **Expansion valve failure** - An expansion valve failure is generally caused by dirt or debris entering the system during assembly. If an expansion valve fails it will be indicated by abnormal gauge readings. A valve that is blocked will be indicated by high side that is unusually high, while the low side will be unusually low or may even go into a vacuum. A valve that is stuck open will be indicated by both the high and low pressures rising to unusually high readings, seeming to move toward equal readings on the gauges.
- H. **Restrictions in system** - A restriction in the cooling system will cause abnormal readings on the gauges. A high-side restriction ( between the compressor and the drier inlet ) will be indicated by the discharge gauges reading excessively high. These simple tests can be performed by a local shop and can help determine the extent of the systems problem.

## Trouble Shooting Your Classic Auto Air A/C System

**PROBLEM: system is not cooling properly**

**ISSUE: cold at idle, warmer when raising engine RPM's**

### Make sure the Water Valve is positioned correctly

The water valve is a directional valve and should be installed with the arrow pointing towards the water pump, it should be connected to the heater hose that runs from the heater core to the water pump. If the water valve is connected to the incorrect hose it allows water to circulate through the system via the heater core over powering the cooling effect of the A/C coil, (normally the air conditioning is functioning properly).

**Step 1:** Check placement of the water valve, correct if needed. (In some cases changing the location of the water valve may not fix the above problem.) Continue to next step.

**Step 2** If changing the location of the water valve does not rectify the issue, then possibly the water valve is permanently damaged and may need to be replaced. To check the integrity of the water valve completely remove the water hoses for the heater core and "loop" together. (This will remove the heater system completely from the possibilities) If the system now cools, replace the water valve

### **Verify Adequate Air Flow to Condenser**

For an air conditioning system to function properly there has to be adequate airflow across the condenser. The function of the condenser is to dissipate heat, without proper airflow your system will not cool correctly in the cabin of your vehicle.

**Step 1:** connect gauges to a/c hoses. The pressures should be: with the ambient temp is 90, low side pressures should be between 10-25 psi, high side pressures should be between 150-275 psi

**Step 2:** IF the low side pressures are normal and the high side pressures are high then there might be an airflow issue, continue to next step.

### **To test air flow to Condenser do the following three tests:**

1. Place a piece of paper on the condenser with the car in idle and see if paper is held in place.
2. With car in idle, attach gages, and place a large capacity fan in front of the condenser. What happens to the pressures?
3. With car still in idle and gages attached, pour water down the front of the condenser. What happens to the pressures?

If the paper is held in place you are at least getting some air flow. If the high side decreases during test 2 & 3 then your condenser is not getting enough air which is causing your system to not cool properly. To correct this issue you will need a more powerful mechanical fan.

### **Step 3: Confirm correct Refrigerant charge in System**

All of our systems should be charged with 24 oz or 1.5 lbs of R134A Refrigerant only. If overcharged you will need to evacuate the system and recharge with the correct amount.\*

### **What measurements mean:**

Low Temp and High Pressure seem to be equal...

You have a malfunctioning expansion valve that is stuck open.

High Side is extremely high and Low Side is extremely low (possibly into vacuum)...

There is a blockage in the system. Remove hoses and blow compressed air through in both directions. If pressures don't change its possible that your expansion valve is stuck closed and would have to be replaced.

### **\*Compressor Concerns:**

This is often misdiagnosed as a problem for the system not cooling properly. If you have a noisy compressor it is due to improper charging of refrigerant. An overcharged (more than 24 oz or 1.5 lbs R134A) compressor can cause rattling. If charged with pure liquid there is a high probability you have bent reed valves that are causing tapping sound.

## Classic Auto Air Hardware Reference Guide

This is our basic line-up of hardware. No single kit will not contain all of these, but you can use this guide to match-up hardware for shape and size (**all of these are actual size**).

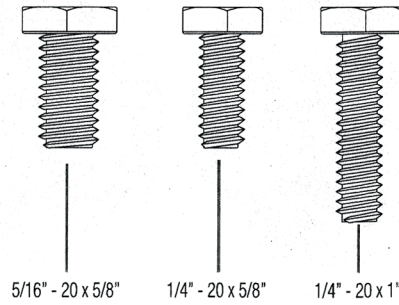
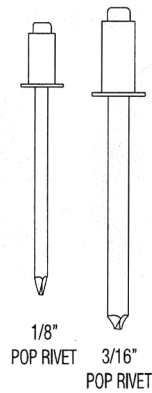
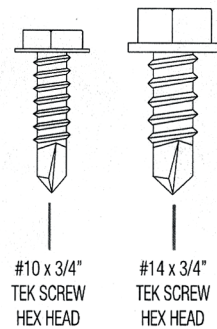
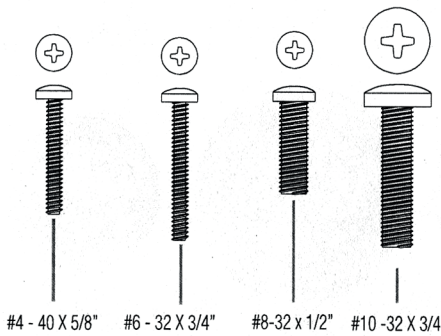
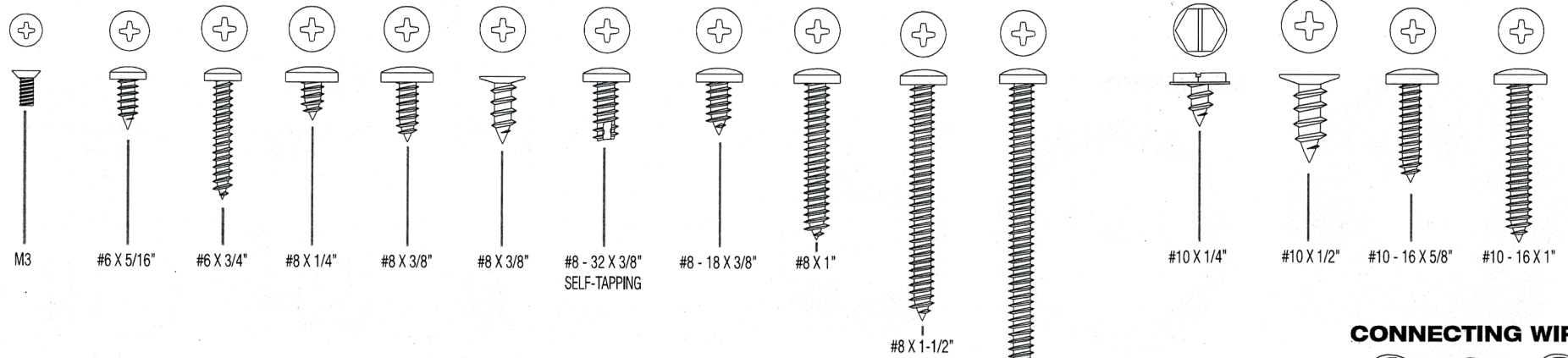

### CONNECTING WIRE

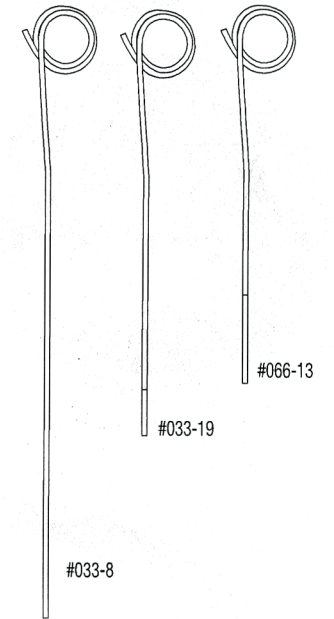

### LOCK NUTS



### NUTS AND WASHERS

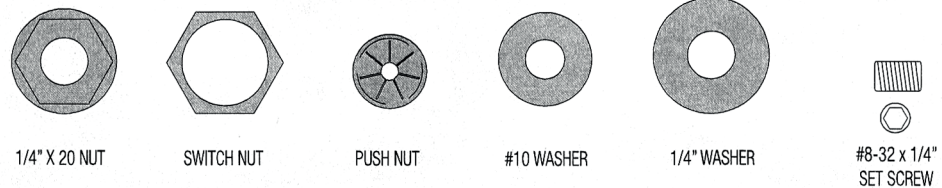

**ORINGS**

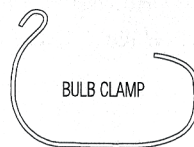
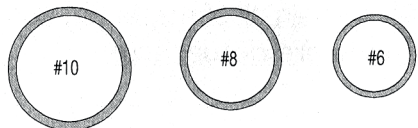

**CLIPS**

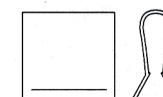
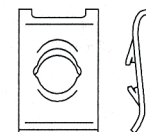
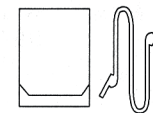
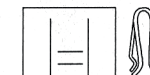
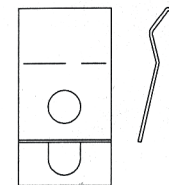
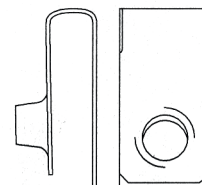

**GROMMETS**

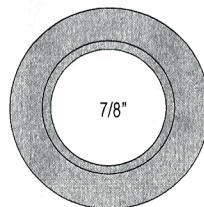
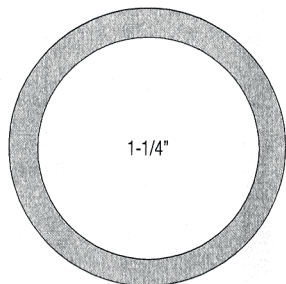
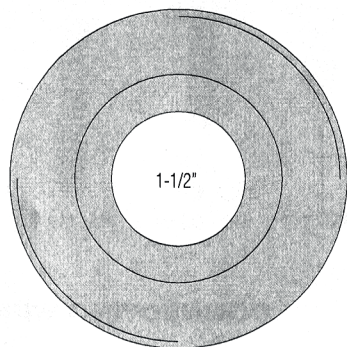

**HOLE PLUGS**

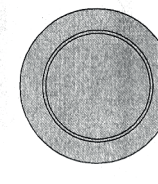
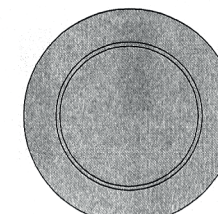
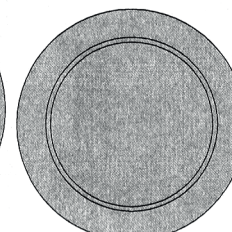
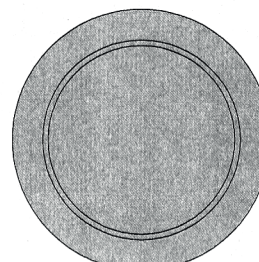
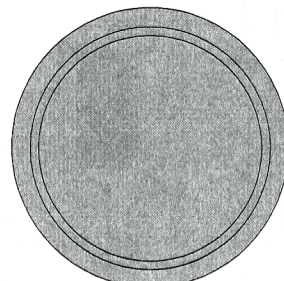
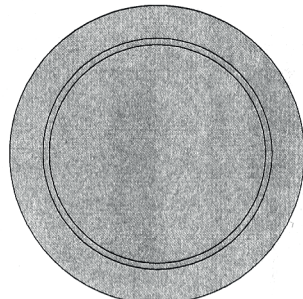
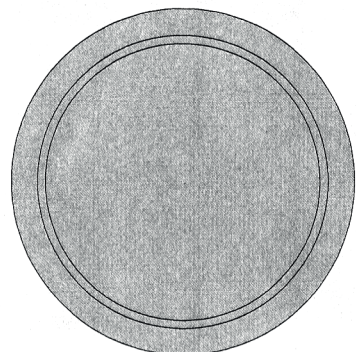

**HOSE CLAMPS**

